



# OWNER'S MANUAL

Mii



## About this manual

This manual contains a description of the **equipment** supplied with the vehicle at the time this manual was published. Some of the units described herein will not be available until a later date or are only available in certain markets.

**Because this is a general manual for the MII, some of the equipment and functions that are described in this manual are not included in all types or variants of the model; they may vary or be modified depending on the technical requirements and on the market; this is in no way deceptive advertising.**

The **illustrations** are intended as a general guide and may vary from the equipment fitted in your vehicle in some details.

The **steering indications** (left, right, forward, reverse) appearing in this manual refer to the normal driving movements of the vehicle except when otherwise indicated.

★ The **equipment marked with an asterisk\*** is fitted as standard only in certain versions, and is only supplied as optional extras for some versions, or are only offered in certain countries.

® All **registered marks** are indicated with ®. Although the copyright symbol does not appear, it is a copyrighted mark.

» The section is continued on the following page.

### WARNING

Texts preceded by this symbol contain information on safety. They warn you about possible dangers of accident or injury.

### CAUTION

Texts with this symbol draw your attention to potential sources of damage to your vehicle.

### For the sake of the environment

Texts preceded by this symbol contain relevant information concerning environmental protection.

### Note

Texts preceded by this symbol contain additional information.

This manual is divided into five large parts, which are:

1. Safety
2. Operation
3. Tips
4. Technical data
5. Alphabetical index

At the end of this manual, there is a detailed alphabetical index that will help you quickly find the information you require.

## Foreword

This Instruction Manual and its corresponding supplements should be read carefully to familiarise yourself with your vehicle.

Besides the regular care and maintenance of the vehicle, its correct handling will help preserve its value.

**For safety reasons, always note the information concerning accessories, modifications and part replacements.**

If selling the vehicle, give all of the on-board documentation to the new owner, as it should be kept with the vehicle.

You can access the information in this manual using:

- Thematic table of contents that follows the manual's general chapter structure.
- Alphabetical index with many terms and synonyms to help you find information.

### WARNING

**Read and always observe safety information concerning the passenger's front airbag »» page 25, Important information regarding the front passenger's airbag.**



## Table of Contents

<b>Safety</b> .....	5	Windscreen wiper and rear window wiper systems .....	60	<b>Advice</b> .....	118
<b>Safe driving</b> .....	5	Rear vision mirror .....	61	<b>Care and maintenance</b> .....	118
Safety first! .....	5	<b>Seats and head restraints</b> .....	63	Accessories, replacement of parts and modifications .....	118
Tips for driving .....	5	Adjusting the seat and head restraints .....	63	Care and cleaning the vehicle exterior .....	125
Correct sitting position for vehicle occupants .....	6	Seat functions .....	64	Caring for and cleaning the vehicle interior ...	131
Pedal area .....	10	<b>Transport and practical equipment</b> .....	65	Notes for the user .....	134
<b>Seat belts</b> .....	11	Transporting objects .....	65	<b>Checking and refilling levels</b> .....	137
Using seat belts .....	11	Practical equipment .....	67	Fuel .....	137
How to properly adjust your seatbelt .....	15	Loading luggage compartment .....	73	Filling the tank .....	139
Seat belt tensioners .....	16	Roof carrier system .....	77	Bonnet .....	143
<b>Airbag system</b> .....	17	<b>Air conditioning</b> .....	80	Engine oil .....	146
Brief introduction .....	17	Heating, ventilation and air conditioning system .....	80	Engine coolant .....	150
General overview of the airbag .....	21	<b>Driving</b> .....	84	Brake fluid .....	152
Deactivating airbags .....	23	Steering .....	84	Checking and topping up the windscreen washer reservoir with water .....	154
<b>Transporting children safely</b> .....	25	Stopping and starting the engine .....	86	Vehicle battery .....	154
Child safety .....	25	Braking and parking .....	89	<b>Wheels and tyres</b> .....	158
<b>Operation</b> .....	35	Changing gear .....	93	Wheels .....	158
<b>Cockpit</b> .....	35	Run-in and economical driving .....	98	<b>Emergencies</b> .....	170
Overview .....	34	Engine management and exhaust gas purification system .....	101	In case of emergency .....	170
Instruments .....	36	Driving abroad .....	102	Vehicle tool kit* .....	172
Control lamps .....	39	Driving along flooded roadways .....	103	Changing a wheel .....	174
SEAT information system .....	40	<b>Driver assistance systems</b> .....	103	Tyre repair .....	178
<b>Opening and closing</b> .....	43	Braking and stability systems .....	103	Starting assistance .....	181
Vehicle key set .....	43	Parking sensor system* .....	105	Towing and tow starting .....	183
Central locking* and locking system .....	45	Cruise control* (Cruise control system - CCS) ..	107	Emergency locking and unlocking .....	186
Doors .....	49	Safety Assist* (City Safety Assist function) ....	110	Changing the windscreen wiper blades .....	188
Rear lid .....	50	Hill driving assistant* .....	114	<b>Fuses and bulbs</b> .....	189
Electric windows .....	52	Start-Stop system .....	115	Fuses .....	189
Sliding/tilting electric panoramic sunroof .....	53	<b>Towing bracket device</b> .....	117	Changing bulbs .....	191
<b>Lights and visibility</b> .....	55	Trailer coupling .....	117	<b>Technical specifications</b> .....	197
Lights .....	55			<b>Technical features</b> .....	197
Visibility .....	59			Important information .....	197
				Wheels .....	199
				Engine specifications .....	200

## Table of Contents

Dimensions .....	203
Capacities .....	203
<b>Index</b> .....	205

## Safety

### Safe driving

#### Safety first!

##### WARNING

• This manual contains important information about the operation of the vehicle, both for the driver and the passengers. The other sections of the on-board documentation also contain further information that you should be aware of for your own safety and for the safety of your passengers.

• Ensure that the on-board documentation is kept in the vehicle at all times. This is especially important when lending or selling the vehicle to another person.

##### WARNING

Driving under the influence of alcohol, drugs, medication or narcotics may result in severe accidents and even loss of life.

• Alcohol, drugs, medication and narcotics may significantly alter perception, affect reaction times and safety while driving, which could result in the loss of control of the vehicle.

### Tips for driving

#### Before starting every trip

For your own safety and the safety of your passengers, always note the following points before every trip:

- Make sure that the vehicle's lights and turn signals are working properly.
- Check tyre pressure.
- Ensure that all windows provide a clear and good view of the surroundings.
- Make sure all luggage is secured »» page 65.
- Make sure that no objects can interfere with the pedals.
- Adjust front seat, head restraint and rear vision mirrors properly according to your size.
- Ensure that the passengers in the rear seats always have the head restraints in the in-use position »» page 9.
- Instruct passengers to adjust the head restraints according to their height.
- Protect children with appropriate child seats and properly applied seat belts »» page 25.

- Assume the correct sitting position. Instruct your passengers also to assume a proper sitting position. »» page 6.
- Fasten your seat belt securely. Instruct your passengers also to fasten their seat belts properly. »» page 11.

#### What affects driving safety?

As a driver, you are responsible for yourself and your passengers. When your concentration or driving safety is affected by any circumstance, you endanger yourself as well as others on the road »» , for this reason:

- Always pay attention to traffic and do not get distracted by passengers or telephone calls.
- Never drive when your driving ability is impaired (e.g. by medication, alcohol, drugs).
- Observe traffic laws and speed limits.
- Always reduce your speed as appropriate for road, traffic and weather conditions.
- When travelling long distances, take breaks regularly - at least every two hours.
- If possible, avoid driving when you are tired or stressed. »»

**WARNING**

When driving safety is impaired during a trip, the risk of injury and accidents increases.

### Safety equipment

Never put your safety or the safety of your passengers in danger. In the event of an accident, the safety equipment may reduce the risk of injury. The following list includes most of the safety equipment in your SEAT:

- Three-point seat belts
- belt tension limiters for the front and rear side seats,
- Belt tensioners for the front seats
- Belt height adjustment for the front seats
- Front airbags
- Side airbags in the front seat backrests
- Side airbags in the rear seat backrests\*
- Head-protection airbags
- Active front head restraints\*
- "ISOFIX" anchor points for child seats in the rear side seats with the "ISOFIX" system,
- Height-adjustable front head restraints
- Rear head restraints with in-use position and non-use position
- Adjustable steering column

The safety equipment mentioned above works together to provide you and your passengers with the best possible protection in the event of an accident. However, these safety systems can only be effective if you and your passengers are sitting in a correct position and use this equipment properly.

**Safety is everyone's business!**

## Correct sitting position for vehicle occupants

### Correct sitting position

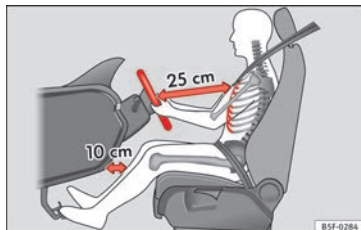

**Fig. 1** The proper distance between driver and steering wheel

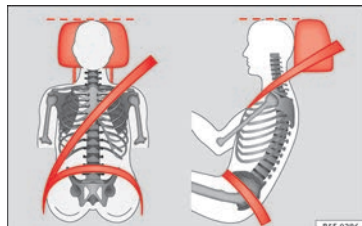

**Fig. 2** Correct belt web and head restraint positions

The correct sitting positions for the driver and passengers are shown below.

If your physical constitution prevents you from maintaining the correct sitting position, contact a specialised workshop for help with any special devices. The seat belt and airbag can only provide optimum protection if a correct sitting position is adopted. SEAT recommends taking your car in for technical service.

For your own safety and to reduce the risk of injury in the event of an accident or sudden braking or manoeuvre, SEAT recommend the following positions:

#### Valid for the driver:

- Adjust the seat backrest to an upright position so that your back rests completely against it.

- Adjust the seat so that there is a distance of at least 25 cm between the steering wheel and your chest »» Fig. 1 and so that you can hold the steering wheel with both hands on the outside of the ring at the 9 o'clock and 3 o'clock positions with your arms slightly bent.
- The adjusted steering wheel must face your chest and not your face.
- Adjust the driver seat forwards or backwards so that you are able to press the accelerator, brake and clutch pedals to the floor with your knees slightly angled and the distance between your knees and the dash panel is at least 10 cm »» Fig. 1.
- Adjust the height of the driver seat so that you can easily reach the top of the steering wheel.
- Keep both feet in the footwell so that you have the vehicle under control at all times.
- Adjust and fasten your seat belt correctly »» page 11.

#### Valid for the passenger:

- Adjust the seat backrest to an upright position so that your back rests completely against it.
- Move the front passenger seat back as far as possible for optimum protection should the airbag deploy.
- Always keep your feet in the footwell while the vehicle is in motion.

- Adjust and fasten your seat belt correctly »» page 11.

#### Valid for the passengers in the rear section:

- Adjust the head restraint so that its upper edge is at the same level as the top of your head, or as close as possible to the same level as the top of your head and under no circumstances below eye level. Keep the back of your neck as close as possible to the head restraint »» Fig. 1 and »» Fig. 2.
- Short people must lower the head restraint to the first anchorage position, even if your head is below its upper edge.
- Tall people must raise the head restraint completely.
- Always keep your feet in the footwell while the vehicle is in motion.
- Adjust and fasten your seat belt correctly »» page 11.

### Adjusting the steering wheel position

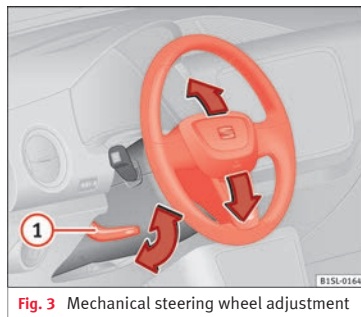

Fig. 3 Mechanical steering wheel adjustment

Adjust the steering wheel before your trip and only when the vehicle is stationary.

- Push the lever »» Fig. 3 ① downwards.
- Adjust the steering wheel so that you can hold onto the steering wheel with both hands on the outside of the ring at the 9 o'clock and 3 o'clock positions and your arms slightly bent.
- Push the lever firmly upwards until it is flush to the steering column »» ⚠.

Adjust the correct distance between the driver and the steering wheel »» Fig. 1 using the controls on the driver seat »» page 63. »»

**⚠ WARNING**

Incorrect use of the steering wheel adjustment function and an incorrect adjustment of the steering wheel can result in severe or fatal injury.

- After adjusting the steering column, push the lever » Fig. 3 ① firmly upwards to ensure the steering wheel does not accidentally change position while driving.
- Never adjust the steering wheel while the vehicle is in motion. If you need to adjust the steering wheel while the vehicle is in motion, stop safely and make the proper adjustment.
- The adjusted steering wheel should be facing your chest and not your face so as not to hinder the driver's front airbag protection in the event of an accident.
- When driving, always hold the steering wheel with both hands on the outside of the ring at the 9 o'clock and 3 o'clock positions to reduce injuries when the driver's front airbag deploys.
- Never hold the steering wheel at the 12 o'clock position or in any other manner (e.g. in the centre of the steering wheel). In such cases, if the driver's airbag deploys, you may sustain injuries to your arms, hands and head.

**Danger of injuries due to an incorrect sitting position****Number of seats**

The vehicle has a total of **4** seats: 2 front seats and 2 rear seats. Each seat is equipped with a seat belt.

If the seat belts are worn incorrectly or not at all, the risk of severe injuries increases. Seat belts can provide optimal protection only if the belt web is properly worn. Being seated in an incorrect position means the seat belt cannot offer its full protection. This could result in severe and even fatal injuries. The risk of severe or fatal injuries is especially heightened when a deploying airbag strikes a vehicle occupant who has assumed an incorrect sitting position. The driver is responsible for all passengers in the vehicle, particularly children.

The following list shows just some examples of incorrect sitting positions which can be dangerous to all vehicle occupants.

**When the vehicle is in motion:**

- Never stand in the vehicle.
- Never stand on the seats.
- Never kneel on the seats.
- Never tilt your seat backrest too far to the rear.
- Never lean against the dash panel.

- Never lie on the rear seats.
- Never sit on the front edge of a seat.
- Never sit sideways.
- Never lean out of a window.
- Never put your feet out of a window.
- Never put your feet on the dash panel.
- Never put your feet on the surface of a seat or seat backrest.
- Never travel in a footwell.
- Never travel on a seat without wearing the seat belt.
- Never carry any person in the luggage compartment.

**⚠ WARNING**

An incorrect sitting position in the vehicle can lead to severe injuries or death in the event of sudden braking or manoeuvres, collision or accidents or if the airbag deploys.

- Before the vehicle moves, assume the proper sitting position and maintain it throughout the trip. This also includes fastening the seat belt.
- Never transport more people than there are seats with a seat belt available in the vehicle.
- Children must always be protected with an approved child restraint system suited to their height and weight » page 25, » page 17.

- Always keep your feet in the footwell while the vehicle is in motion. Never, for example, put your feet on the surface of a seat or on the dash panel and never put them out of a window. Otherwise the airbag and seat belt offer insufficient protection and the risk of injury in the event of an accident is increased.

#### **⚠ WARNING**

Before every trip, adjust the seat, the seat belt and the head restraints and instruct your passengers to fasten their seat belts properly.

- Move the front passenger seat back as far as possible.
- Adjust the driver seat so that there is at least 25 cm distance between your chest and the hub of the steering wheel. Adjust the driver seat so that you are able to press the accelerator, brake and clutch pedals to the floor with your knees slightly angled and that the distance between your knees and the dash panel is at least 10 cm. If your physical constitution prevents you from meeting these requirements, contact a specialised workshop to make any modifications required.
- Never drive with the seat backrest tilted far back. The further the seat backrests are tilted to the rear, the greater the risk of injury due to incorrect positioning of the belt web or to the incorrect sitting position!
- Never drive with the seat backrest tilted forwards. Should a front airbag deploy, it

could throw the seat backrest backwards and injure the passengers of the rear seats.

- Sit as far away as possible from the steering wheel and the dash panel.
- Keep your back straight and resting completely against the seat backrest and the front seats correctly adjusted. Never place any part of your body in the area of the airbag or very close to it.
- If passengers on the rear seats are not sitting in an upright position, the risk of severe injury due to incorrect positioning of the belt web increases.

#### **⚠ WARNING**

Incorrect seat adjustment may lead to accidents and severe injuries.

- Only adjust the seats when the vehicle is stationary, as the seats could move unexpectedly while the vehicle is in motion and you could lose control of the vehicle. Furthermore, an incorrect position is adopted when adjusting the seat.
- Only adjust the height, seat backrest and forwards or backwards position of the seat when there is nobody in the seat adjustment area.
- There must be no objects blocking the front seat adjustment area.

## Adjust the rear head restraints

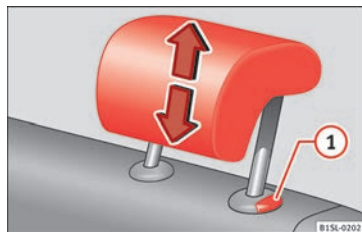

Fig. 4 Adjusting the rear head restraints

All seats are equipped with a head restraint.

The front seat head restraints are integrated in the backrests and adjusting them is not possible.

### Adjusting height

- Push the head restraint up or down in the direction of the arrow with the button pressed » Fig. 4 ① » ⚠.
- The head restraint must engage securely in position.

### Correct adjustment of head restraints

Adjust the head restraint so that its upper edge is at the same level as the top of your head, or as close as possible to the same level as the top of your head and under no circumstances below eye level. Keep the back »

of your neck as close as possible to the head restraint.

### Adjusting the head restraint for short people

Set the head restraint in the first anchorage position, even if your head is below its upper edge. When the head restraint is at its lowest, it is possible that a small gap remains between it and the seat backrest.

### Adjusting the head restraint for tall people

Raise the head restraint completely.

#### WARNING

Travelling with the head restraints removed or improperly adjusted increases the risk of severe or fatal injuries in the event of accidents and sudden braking or manoeuvres.

- Always fit and adjust the head restraint properly whenever a person is occupying a seat.
- All vehicle occupants must correctly adjust the head restraint according to their height to reduce the risk of back injuries in the event of an accident. The upper edge of the head restraint must be as close as possible to the same level as the top of your head and under no circumstances below eye level. Keep the back of your neck as close as possible to the head restraint.
- Never adjust the head restraint while the vehicle is in motion.

## Pedal area

### Pedals

Do not allow floor mats or other objects to obstruct the free passage of the pedals.

Floor mats should leave the pedal area free and unobstructed and be correctly secured in the footwell zone.

In the event of failure of a brake circuit, the brake pedal must be pressed harder than normal to brake the vehicle.

pedal will need to be pressed further to stop the vehicle. To press the brake pedal down further will require more force than usual.

#### WARNING

Objects falling into the driver's footwell could prevent use of the pedals. This could lead the driver to lose control of the vehicle, increasing the risk of a serious accident.

- Make sure the pedals can be used at all times, with no objects rolling underneath them.
- Always secure the mat in the footwell.
- Never place other mats or rugs on top of the original mat supplied by the factory.
- Ensure that no objects can fall into the driver's footwell while the vehicle is in motion.

#### CAUTION

The pedals must always have free and unobstructed passage to the floor. For example, in case of a fault in the brake circuit, the brake

## Seat belts

### Using seat belts

#### Introduction

Check the condition of all the seat belts at regular intervals. If you notice that the belt webbing, fittings, retractor mechanism or buckle of any of the belts is damaged, the belt must be replaced immediately by a specialised workshop »» » ⚠. The specialised workshop must use the appropriate spare parts corresponding to the vehicle, the equipment and the model year. SEAT recommends taking your car in for technical service.

#### ⚠ WARNING

Unbuckled or badly buckled seat belts increase the risk of severe or even fatal injuries. The seat belt cannot offer its full protection if it is not fastened and used correctly.

- Seat belts are the most effective way of reducing the risk of sustaining severe or fatal injuries in the event of an accident. Seat belts must be correctly fastened when the vehicle is in motion to protect the driver and all vehicle occupants.
- Before each trip, every occupant in the vehicle occupants must sit properly, correctly fasten the seat belt belonging to his or her seat and keep it fastened throughout the trip.

This also applies to other vehicle occupants when driving in town.

- When travelling, children must be secured in the vehicle with a child restraint system suitable for their weight and height and with the seat belts correctly fastened »» » page 25.
- Instruct your passengers to fasten their seat belts properly before driving off.
- Insert the latch plate into the buckle for the appropriate seat and ensure it is engaged. Using the latch plate in the buckle of another seat will not protect you properly and may cause severe injuries.
- Do not allow liquids or foreign bodies to enter the buckle fastenings. This could damage the buckles and seat belts.
- Never unbuckle your seat belt when the vehicle is moving.
- Never allow more than one passenger to share the same seat belt.
- Never hold children or babies on your lap sharing the same seat belt.
- Loose, bulky clothing (such as a jacket) impairs the proper fit and function of the seat belt.

#### ⚠ WARNING

It is extremely dangerous to drive using damaged seat belts and could result in serious injury or loss of life.

- Avoid damaging the seat belt by jamming it in the door or the seat mechanism.
- If the fabric or other parts of the seat belt are damaged, the seat belts could break in the event of an accident or sudden braking.
- Always have damaged seatbelts replaced immediately by seat belts approved for the vehicle in question by SEAT. Seat belts which have been worn in an accident and stretched must be replaced by a specialised workshop. Renewal may be necessary even if there is no apparent damage. The belt anchorage should also be checked.
- Never attempt to repair, modify or remove a seat belt yourself. All repairs to seat belts, retractors and buckles must be carried out by a specialised workshop.

## Warning lamp



Fig. 5 Warning lamp on the instrument panel

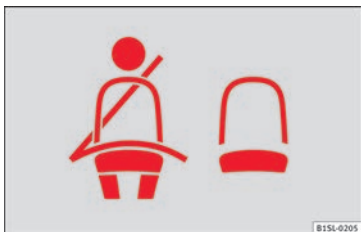







Fig. 6 Indication of seat belt status in the rear seats on the instrument panel display

Lights up or flashes	Possible cause	Solution
	On the instrument panel: Driver's seat belt not fastened or front passenger seat belt not fastened if the front passenger seat is occupied.	Fasten seat belts!
	On the instrument panel: Objects on the front passenger seat.	Remove any objects from the front passenger seat and store them safely.
	Instrument panel display: a passenger in the rear seats has not fastened their seat belt, if the seat is occupied.*	Fasten seat belts!
	On the instrument panel display: a passenger in the rear seats has fastened their seat belt, if the seat is occupied.*	

Several warning and control lamps light up for a few seconds when the ignition is switched on, signalling that the function is being verified. They will switch off after a few seconds.

An audible warning will be heard if the seat belts are not fastened as the vehicle drives off and reaches a speed of more than

25 km/h (15 mph) or if the seat belts are unfastened while the vehicle is in motion. The seat belt warning lamp  will also flash.

The warning lamp  does not switch off until the driver and front passenger fasten their seat belts while the ignition is switched on.

### Seat belt status display for rear seats

The seat belt status display on the instrument panel informs the driver, when the ignition is switched on, whether any passengers in the rear seats have fastened their seat belts. The symbol  indicates that the passenger in this seat has fastened "his or her" seat belt **»» Fig. 6.**

The seat belt status is displayed for around 30 seconds when a seat belt in the rear seats is fastened or unfastened. You can switch off this display by pressing the **(0.0 / SET)** button.

The seat belt status flashes for a maximum of 30 seconds when a seat belt in the rear seats is unfastened while the vehicle is in motion. An audible warning will also be heard if the vehicle is travelling at over 25 km/h (15 mph).

## Seat belt protection



**Fig. 7** Drivers with properly worn seat belts will not be thrown forward in the event of sudden braking

Properly worn seat belts hold the occupants in the proper position. They also help prevent uncontrolled movements that may result in serious injury and reduce the risk of being thrown out of the vehicle in case of an accident.

Vehicle occupants wearing their seat belts correctly benefit greatly from the ability of the belts to absorb kinetic energy. In addition, the front part of your vehicle and other passive safety features (such as the airbag system) are designed to absorb the kinetic energy released in a collision. Taken together, all these features reduce the releasing kinetic energy and consequently, the risk of injury. This is why it is so important to fasten seat belts before every trip, even when "just driving around the corner".

Ensure that your passengers wear their seat belts as well. Accident statistics have shown that wearing seat belts is an effective means of substantially reducing the risk of injury and improving the chances of survival when involved in a serious accident. Furthermore, properly worn seat belts improve the protection provided by airbags in the event of an accident. For this reason, wearing a seat belt is required by law in most countries.

Although your vehicle is equipped with airbags, the seat belts must be fastened and worn. The front airbags, for example, are only triggered in some cases of head-on collision. The front airbags will not be triggered during minor frontal or side collisions, rear-end collisions, rollovers or accidents in which the airbag trigger threshold value in the control unit is not exceeded.

Therefore, you should always wear your seat belt and ensure that all vehicle occupants have fastened their seat belts properly before you drive off!

## Using seat belts

### Twisted seat belt

If it is difficult to remove the seat belt from the guide, the seat belt may have become twisted inside the side trim after being wound too quickly on unfastening:

- Pull out the seat belt completely, carefully pulling on the latch plate.
- Untwist the belt and guide it back, assisting it by hand.

The seat belt must be fastened even if it is impossible to untwist it. In this case, the twisted area must not be in an area in direct contact with your body. Have the seat belt untwisted urgently by a specialised workshop.

### **⚠ WARNING**

**An improperly handled seat belt increases the risk of sustaining severe or fatal injuries.**

- Regularly check that the seat belts and their components are in perfect condition.
- Always keep your seat belt clean.
- Do not jam or damage the seat belt or rub it with sharp edges.
- Make sure there are no liquids or foreign bodies on the latch plate and in the buckle.

## Head-on collisions and the laws of physics



**Fig. 8** A driver not wearing a seat belt is thrown forward violently



**Fig. 9** The unbelted passenger in the rear seat is thrown forward violently, hitting the driver who is wearing a seat belt.

It is easy to explain how the laws of physics work in the case of a head-on collision: when a vehicle starts moving, a type of energy

called “kinetic energy” is created both in the passengers and inside the vehicle.

The amount of “kinetic energy” depends on the speed of the vehicle and the weight of the vehicle and its passengers. The higher the speed and the greater the weight, the more energy there is to be “absorbed” in an accident.

The most significant factor, however, is the speed of the vehicle. If the speed doubles from 25 km/h (15 mph) to 50 km/h (30 mph), for example, the corresponding kinetic energy is multiplied by four.

Because the vehicle occupants in our example are not restrained by seat belts, in the event of crashing against a wall, all of the occupants’ kinetic energy will be absorbed solely by said impact.

Even at speeds of 30 km/h (19 mph) to 50 km/h (30 mph), the forces acting on bodies in a collision can easily exceed one tonne (1000 kg). At greater speed these forces are even higher.

Vehicle occupants not wearing seat belts are not “attached” to the vehicle. In a head-on collision, they will move forward at the same speed their vehicle was travelling just before the impact. This example applies not only to head-on collisions, but to all accidents and collisions.

Even at low speeds the forces acting on the body in a collision are so great that it is not possible to brace oneself with one's hands. In a frontal collision, unbelted passengers are thrown forward and will make violent contact with the steering wheel, dash panel, windscreen or whatever else is in the way **» Fig. 8.**

It is also important for rear passengers to wear seat belts properly, as they could otherwise be thrown forward violently through the vehicle interior in an accident. Passengers in the rear seats who do not use seat belts endanger not only themselves but also the front occupants **» Fig. 9.**

## How to properly adjust your seatbelt

### Fastening and unfastening the seat belt

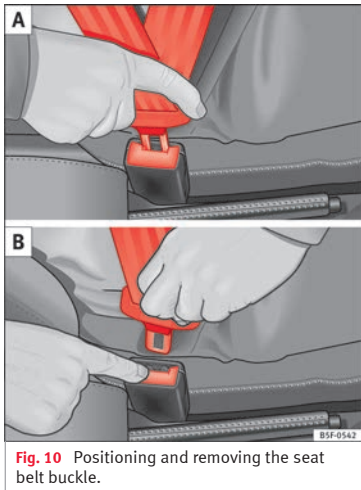

**Fig. 10** Positioning and removing the seat belt buckle.



**Fig. 11** Position of seat belt during pregnancy.

Properly worn seat belts hold the vehicle occupants in the position that most protects them in the event of an accident or sudden braking » » » **△**.

### Fastening the seat belt

Fasten your seat belt before each trip.

- Correctly adjust the front seat » » » **page 6**.
- Engage the seat backrest in the upright position and correctly adjust the head restraint » » » **△**.
- Pull the latch plate and place the belt webbing evenly across your chest and lap. Do **not** twist the seat belt when doing so » » » **△**.
- Engage the latch plate in the buckle of the corresponding seat » » » **Fig. 10 A**.

- Pull the belt to ensure that the latch plate is securely engaged in the buckle.

### Unfastening the seat belt

The seat belt must not be unfastened until the vehicle has come to a standstill » » » **△**.

- Press the red button on the buckle » » » **Fig. 10 B**. The latch plate is released from the buckle.
- Guide the belt back by hand so that it rolls up easily and the trim will not be damaged.

### Correct seat belt position

Seat belts offer their maximum protection in the event of an accident and reduce the risk of sustaining severe or fatal injuries only when they are properly positioned. Furthermore, if the webbing is correctly positioned, the seat belt will hold the vehicle occupants in the optimum position to ensure the airbag provides the maximum protection. The seat belt must therefore always be worn and the webbing correctly positioned.

Incorrectly worn seat belts can cause severe or even fatal injuries » » » **page 6**, **Correct sitting position for vehicle occupants**.

- The shoulder part of the seat belt must lie on the centre of the shoulder, never across the neck or the arm, under the arm or behind the shoulder.

»

- The lap part of the seat belt must lie across the pelvis, never across the stomach.
- The seat belt must lie flat and fit comfortably. Pull the belt tight if necessary to take up any slack.

In the case of **pregnant women**, the seat belt must lie evenly across the chest and as low as possible over the pelvis, never across the stomach and must be worn properly at all times during the pregnancy »» **Fig. 11.**

### Adapting the position of the belt webbing to your size

The seat belt can be adapted using the following equipment:

- Front seat height adjustment.

#### WARNING

An incorrectly worn seat belt web can cause severe or fatal injuries in the event of an accident.

- The seat belt cannot offer its full protection unless the seat backrest is in an upright position and the seat belt is worn correctly, according to your size.
- Unbuckling your seat belt while the vehicle is in motion can cause severe or fatal injuries in the event of an accident or sudden braking.
- The seat belt itself or a loose seat belt can cause severe injuries if the belt moves from

hard areas of the body to soft areas (e.g. the stomach).

- The shoulder part of the seat belt must lie on the centre of the shoulder, never across the neck or the arm.
- The seat belt must lie flat and fit comfortably on the torso
- The lap part of the seat belt must lie across the pelvis, never across the stomach. The seat belt must lie flat and fit comfortably on the pelvis Pull the belt tight if necessary to take up any slack.
- For pregnant women, the lap part of the seat belt must lie as low as possible over the pelvis and always lie flat, “surrounding” the stomach.
- Do not twist the seat belt while it is fastened.
- Never pull the seat belt away from your body using your hand.
- Do not lie the seat belt across rigid or fragile objects, e.g. glasses, pens or keys.
- Never use seat belt clips, retaining rings or similar instruments to alter the position of the belt webbing.

#### Note

If your physical constitution prevents you from maintaining the correct position of the belt webbing, contact a specialised workshop for help with any special devices to ensure the optimum protection of the seat belt and

airbag. SEAT recommends taking your car in for technical service.

## Seat belt tensioners

### Automatic belt retainer, belt tensioner, belt tension limiter

Seat belts are part of the vehicle safety concept »» page 17 and consist of the following important functions:

#### Automatic belt retainer

Every seat belt is equipped with an automatic belt retainer on the shoulder belt. If the belt is pulled slowly or during normal driving, the system allows for total freedom of movement on the shoulder belt. However, during sudden braking, during travel in mountains or bends and during acceleration, the automatic belt retainer on the seat belt is locked is pulled quickly.

#### Belt tensioners

The seat belts for the occupants in the front seats are equipped with belt tensioners.

Sensors trigger the belt tensioners during severe head-on, lateral and rear collisions and retract and tighten the seat belts. If the seat belt is loose, it is retracted to reduce the forwards movement of occupants or movement

in the direction of the collision. The belt tensioner works in combination with the airbag system. The belt tensioner will not be triggered in the event of the vehicle overturning if the side airbags are not deployed.

If the belt tensioner is triggered, a fine dust is produced. This is normal and it is not an indication of fire in the vehicle.

### Belt tension limiter

The belt tension limiter reduces the force of the seat belt on the body in the event of an accident.

#### Note

The relevant safety requirements must be observed when the vehicle is dismantled or system components are removed. These requirements are known to specialised workshops » page 17.

### Service and disposal of belt tensioners

If you work on the belt tensioners or remove and install other parts of the vehicle when performing other repair work, the seat belt may be damaged. The consequence may be that, in the event of an accident, the belt tensioners function incorrectly or not at all.

So that the effectiveness of the belt tensioner is not reduced and that removed parts do not cause any injuries or environmental pollution, regulations must be observed. These requirements are known to specialised workshops.

#### WARNING

**Improper handling and homemade repairs of seat belts, automatic belt retainers and tension devices increase the risk of sustaining severe or fatal injuries. The belt tensioner may fail to trigger or may trigger in the wrong circumstances.**

- Never attempt to repair, adjust or remove or install parts of the belt tensioners or seat belts. Any work must be performed by a specialised workshop only » page 118.
- Belt tensioners and automatic belt retainers cannot be repaired and must be replaced.



#### For the sake of the environment

**Airbag modules and belt tensioners may contain perchlorate. Observe the legal requirements for their disposal.**

## Airbag system

### Brief introduction

#### Introduction

Front airbags have been installed for both driver and passenger. The front airbags can also protect the chest and head of driver and passenger if the seats, seat belts head restraints and, for the driver, the steering wheel are correctly adjusted and used. Airbags are considered as additional safety equipment. An airbag cannot replace the seat belt, which must be worn at all times, even in front seats where front airbags have been installed.

The airbag can protect vehicle occupants in the event of an accidents, cushioning the movement of the occupants in the direction of the collision in frontal and side accidents.

Deployed airbags fill with a propellant gas. This causes the airbag covers to break and the airbags to deploy extremely quickly in their entire deployment space within fractions of a second. When an occupant with the seat belt properly fastened puts pressure on the inflated airbag, the propellant gas escapes to absorb the force of the impact and slow the movement. This reduces the risk of severe or fatal injuries. Airbag deployment does not mean that other types of injury such »

as swelling, bruising and skin injuries can be ruled out. Upon deployment of the airbag, friction can cause the generation of heat.

Airbags do not protect the arms or the lower part of the body.

The most important factors for triggering the airbag are the type of accident, the angle of impact, the vehicle speed and the characteristics of the object the vehicle hits. Therefore, airbags are not triggered every time the vehicle is visibly damaged.

The activation of the airbag system depends on the magnitude of the deceleration of the vehicle caused by a collision, which registers through an electronic control unit. If the deceleration magnitude value is below the reference value programmed in the control unit, the airbags will not deploy even though serious damage might be caused to the vehicle as the result of an accident. Damage suffered by the vehicle, repairation costs or absence of damage suffered from the accident are not indications of whether an airbag should have been deployed. Due to the varying nature of collision situations, it is impossible to define a speed range of the vehicle and reference values. For this reason, it is not possible to cover all types of collisions and collision angles resulting in the deployment of the airbag. Factors necessary for the airbag to be deployed can be, the characteristics of the object (hard or soft) against which the vehi-

cle collides, the collision angle and the vehicle speed.

Airbags act in conjunction with the three-point seat belts in certain accident situations, when the vehicle deceleration rate is severe enough to trigger the airbags. Airbags only deploy once and only under certain circumstances. Seat belts remain present to offer protection in situations where airbags are not triggered or where they have already deployed. For example, when a vehicle hits another after an initial collision or is hit by another vehicle.

The airbag system is an integral part of the car's passive safety system. The airbag system can only work effectively when the vehicle occupants are wearing their seat belts correctly and have adjusted the head restraints properly  **»» page 6.**

### WARNING

**Never exclusively trust the airbag system as a means of protection.**

- Even when triggered, airbag protection is only auxiliary.
- The airbags provide the best protection when the seat belts are properly fastened, thus reducing the risk of sustaining injuries **»» page 11, Using seat belts.**
- Before each trip, every occupant must sit properly, correctly fasten the seat belt belonging to his or her seat and keeping it fas-

**tened throughout the trip. This rule is valid for all vehicle occupants.**

### WARNING

**Occupants sitting in the front of the vehicle must never carry any objects in the deployment space between them and the airbags, as this increases the risk of sustaining injuries if the airbag is triggered. This modifies the airbag deployment space or the objects may fly uncontrollably and hit your body.**

- Never carry objects in your hand or on your lap while the vehicle is in motion.
- Never transport objects on the front passenger seat. In the event of sudden braking and manoeuvres, the objects may end up in the airbag deployment space and fly uncontrollably around the interior if the airbag is activated.
- Occupants of the front and rear seats must never carry any other people, pets or objects in the deployment space between them and the airbags. Make sure children and other passengers also respect this recommendation.

### WARNING

**The airbag system provides protection for one accident only. If they have been deployed, they must be replaced.**

- Ensure deployed airbags and the system components involved are immediately replaced with new, SEAT-approved components for the vehicle.
- Have any repairs or modifications carried out at a specialised workshop. Specialised workshops have the necessary tools, diagnostics equipment, repair information and qualified personnel.
- Never fit recycled or reused airbag components in your vehicle.
- Never modify the airbag system components.

#### WARNING

If the airbags are triggered, a fine dust is produced. This is normal and it is not an indication of fire in the vehicle.

- This fine dust may irritate the skin and eyes and cause breathing difficulties, particularly in people suffering from or who have suffered from asthma or other illnesses of the respiratory tract. To reduce breathing difficulties, get out of the vehicle and open doors and windows to breathe in fresh air.
- Should you touch the dust, wash your hands and face using a mild soap and water before you eat.
- Prevent the dust from affecting the eyes or open wounds.
- Rinse your eyes with water if you have dust in them.

#### WARNING

Solvents cause the surfaces of the airbag modules to become porous. If an airbag is accidentally triggered, the detachment of plastic parts could cause serious injury.

- Never clean the dash panel and the surfaces of the airbag modules with cleaners containing solvents.

### Description of airbag system

#### Vehicle safety components

The following safety equipment makes up the vehicle safety design to reduce the risk of severe and fatal injuries. Depending on the vehicle equipment, some equipment may not be fitted in the vehicle or may not be available in some markets.

- Optimised seat belts for all seats.
- Seat belt tension devices for driver and passenger.
- Seat belt force limiters for driver and passenger.
- Seat belt warning lamp
- Front airbags for driver and passenger.
- Side airbags for driver and passenger.
- Airbag control lamp .
- Control units and sensors.

- Head restraints optimised for rear-end collision.
- Adjustable steering column.
- If necessary, anchor points for child seats for the rear seats.
- Where applicable, mountings for the child seat upper retaining strap.

#### Situations in which the front and side airbags do not deploy:

- If the ignition is switched off during the collision.
- In frontal collisions, when the deceleration measured by the control unit is too low.
- In minor side collisions.
- In rear collisions.
- In the event of the vehicle overturning.
- When the impact speed is lower than the reference value set in the control unit.

#### There is a fault in the system if the control lamp :

- does not light up when the ignition is switched on,
- turns off after 4 seconds after the ignition is switched on
- turns off and then lights up again after the ignition is switched on
- illuminates or flashes while the vehicle is moving.



**⚠ WARNING**

- The seat belts and airbags can only provide maximum protection if the occupants are seated correctly » page 6.
- If a fault has occurred in the airbag system, have the system checked immediately by a specialised workshop. Otherwise, during a frontal collision the system might not trigger correctly or may fail to trigger at all.

**Airbag activation**

The airbags deploy extremely rapidly, within thousandths of a second, to provide additional protection in the event of an accident. A fine dust may develop when the airbag deploys. This is normal and it is not an indication of fire in the vehicle.

The airbag system is only ready to function when the ignition is on.

In special accidents instances, several airbags may activate at the same time.

In the event of minor head-on and side collisions, rear-end collisions, overturning or roll-over of the vehicle, airbags **do not activate**.

**Activation factors**

The conditions that lead to the airbag system activating in each situation cannot be generalised. Some factors play an important role, such as the properties of the object the vehi-

cle hits (hard/soft), angle of impact, vehicle speed, etc.

Deceleration trajectory is key for airbag activation.

The control unit analyses the collision trajectory and activates the respective restraint system.

If the deceleration rate is below the predefined reference value in the control unit the airbags will not be triggered, even though the accident may cause extensive damage to the car.

**The following airbags are triggered in serious head-on collisions**

- Driver airbag.
- Front passenger front airbag

**The following airbags are triggered in serious side-on collisions**

- Front side airbag on the side of the accident.
- Rear side airbag on the side of the accident.

**In an accident with airbag activation:**

- the interior lights switch on (if the interior light switch is in the courtesy light position);
- the hazard warning lights switch on;
- all doors are unlocked;

- the fuel supply to the engine is cut.

## General overview of the airbag

### Front airbags

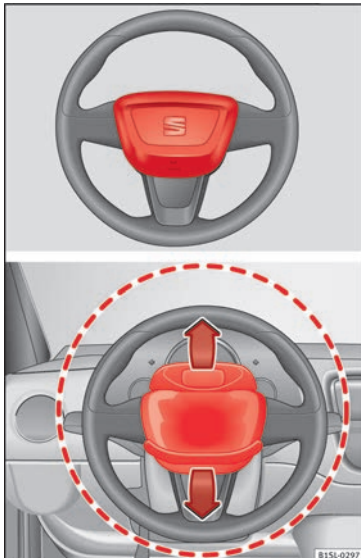

**Fig. 12** Location and deployment area of the front airbag for the driver.

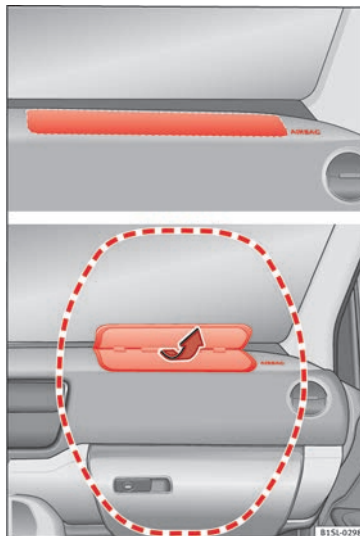

**Fig. 13** Location and deployment area of the front airbag for the passenger.

In conjunction with the seat belts, the front airbag system gives the driver and the front passenger additional protection for the head and chest in the event of a severe frontal collision. Always remain as far away as possible from the front airbag » page 6. This way, in the event of an accident, the front airbags

can deploy fully when triggered, providing maximum protection.

The front airbag for the driver is located in the steering wheel » Fig. 12 and the airbag for the front passenger is located in the dash panel » Fig. 13. Airbags are identified by the word “AIRBAG”.

When the front airbags are triggered they fill the zones marked in red » Fig. 12 and » Fig. 13 (radius of action). Therefore, objects should never be placed or mounted in these areas » ⚠, Factory-fitted accessories are outside the range of the front airbag for the driver and the front passenger, e.g. the baseplate for the mobile phone support.

The airbag covers fold out of the steering wheel » Fig. 12 or dash panel » Fig. 13 when the driver and front passenger airbags are triggered. The airbag covers remain connected to the steering wheel or the dash panel.

#### ⚠ WARNING

**The airbag is deployed at high speed in fractions of a second.**

- Always keep the deployment areas of the front airbags vacant.
- Never secure objects to the covers or in the deployment area of the airbag modules, e.g. drink holders or phone supports.
- The deployment space between the front passengers and the airbags must not in any

case be occupied by other passenger, pets and objects.

- Never fix any object to the windscreen above the front airbag on the front passenger side.
- Do not alter, cover or stick anything to the steering wheel hub or the surface of the airbag module on the passenger side of the dash panel.

### **⚠ WARNING**

Front airbags are deployed in front of the steering wheel » Fig. 12 and the dash panel » Fig. 13.

- When driving, always hold the steering wheel on the outer edge of the ring with both hands: 9 o'clock and 3 o'clock position.
- Adjust the driver seat so that there is a distance of at least 25 cm (10 inches) between the centre of your chest and the hub of the steering wheel. If your physical constitution prevents you from meeting these requirements, make sure you contact a specialised workshop.
- Adjust the front passenger seat so there is as much distance as possible between the front passenger and the dash panel.

## Types of front passenger front airbag systems

There are two different SEAT front passenger front airbag systems:

### A



Characteristics of the passenger front airbag **without disabling.**

- Control lamp  on the instrument panel.\*
- Front passenger front airbag on the dash panel.

Description: airbag system

### B

Characteristics of the front passenger front airbag that can be disabled manually » page 24.

- Control lamp  on the instrument panel.
- Control lamp on the dash panel. **PASSENGER AIR BAG OFF** .
- Switch on the dash panel glove compartment, on the passenger side.
- Front passenger front airbag in the dash panel.

Description: airbag system with front passenger front airbag disabling.

## Side airbags



**Fig. 14** On the side of the front seat: location of the side airbag



**Fig. 15** On the left side of the vehicle: deployment area of side airbag

The side airbags are located in the outer cushion of the driver and front passenger seat backrests » Fig. 14. Their position is indicated by the word "AIRBAG". The area marked in red » Fig. 15 indicates the side airbag deployment zone.

In the event of a side-on collision, the side airbag will deploy in the side of the vehicle affected »» Fig. 15, thus reducing the risk of injuries to passengers on the side of the body and the head facing the accident side.

### ⚠ WARNING

The airbag is deployed at high speed in fractions of a second.

- Always keep the deployment areas of the side airbags vacant.
- The deployment space between the front passengers and the airbags must not in any case be occupied by other passenger, pets and objects.
- Do not mount accessories on the doors.
- Only used protective covers for the seats that are approved for the vehicle. Otherwise, the side airbag would be obstructed when deployed.

### ⚠ WARNING

Incorrect handling of the driver's and front passenger seat could prevent the side airbag from deploying properly and cause severe injuries.

- Never remove the front seats of the vehicle or modify any of their components.
- Great forces must not be exerted on the seat backrest bolsters because the side airbags might not deploy correctly, might not deploy at all or might deploy unexpectedly.

- Any damage to the original seat upholstery or around the seams of the side airbag units must be repaired immediately by a specialised workshop.

## Deactivating airbags

### Control lamps



Fig. 16 Control lamp for disabling the front passenger front airbag on the dash panel

	It lights up on the combi-instrument
Fault in airbag system and seat belt tensioners.	Have the system checked immediately by a specialised workshop.

<b>OFF</b>	It lights up on the dash panel
Fault in the airbag system.	Have the system checked immediately by a specialised workshop.
Front passenger front airbag disabled.	Check whether the airbag should remain disabled.

Several warning and control lamps light up for a few seconds when the ignition is switched on, signalling that the function is being verified. They will switch off after a few seconds.

If the front passenger airbag is deactivated, the lamp **PASSENGER AIR BAG OFF** does not remain lit, or if it is lit together with the control lamp on the dash panel, there may be a fault in the airbag system »» ⚠.

### ⚠ WARNING

In the event of a fault in the airbag system, the airbag may not trigger correctly, may fail to trigger or may even trigger unexpectedly, leading to severe or fatal injuries.

- Have the airbag system checked immediately by a specialised workshop.
- Never mount a child seat in the front passenger seat or remove the mounted child seat! The front passenger front airbag may deploy during an accident in spite of the fault.

**ⓘ CAUTION**

Always pay attention to any lit control lamps and to the corresponding descriptions and instructions to avoid damage to the vehicle.

### Deactivating and activating the front passenger front airbag using the key switch

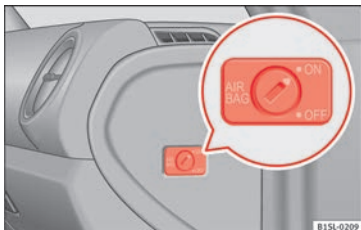

**Fig. 17** On front passenger side: Key switch for enabling and disabling the front passenger front airbag.

**The front passenger front airbag must be disabled when a rear-facing child seat is mounted.**

#### Disabling the front passenger front airbag



- Switch the ignition off.
- Open the door on the front passenger side.
- Unfold the vehicle key shaft » page 43.



- Using the vehicle key, turn the key switch to **OFF** » Fig. 17.
- Close the door on the front passenger side.
- The **PASSENGER AIR BAG OFF**  control lamp on the dash panel will remain lit while the ignition is switched on » page 23.

#### Activating the front passenger front airbag

- Switch the ignition off.
- Open the door on the front passenger side.
- Unfold the vehicle key shaft » page 43.
- Using the vehicle key, turn the key switch to **ON** » Fig. 17.
- Close the door on the front passenger side.
- Check that, with the ignition switched on, the control lamp **PASSENGER AIR BAG OFF**  on the dash panel is *not* lit » page 23.

#### How to know whether the front passenger front airbag is disabled

The **only** indication of the front passenger airbag being disabled is that the **PASSENGER AIR BAG OFF**  control lamp on the dash panel remains lit (**OFF**  stays yellow) » page 23.

If the control lamp **OFF**  on the dash panel **does not remain lit** or is lit in combination with the control lamp  on the instrument panel, a child restraint system cannot be mounted on the front passenger seat for safety reasons. The front passenger front airbag may deploy during an accident.

**⚠ WARNING**

The front passenger front airbag must only be disabled in special cases.

- **Disable and activate the front passenger front airbag when the ignition is switched off to avoid damage to the airbag system.**
- **It is the driver's responsibility to ensure that the key operated switch is set to the correct position.**
- **Only disable the front passenger front airbag when a child seat is to be mounted under exceptional circumstances.**
- **As soon as the child seat is no longer needed on the front passenger seat, reconnect the front passenger front airbag.**

## Transporting children safely

### Child safety

#### Introduction

Before transporting babies and children in a child seat placed in the front passenger seat, first completely read the information regarding the airbag system.

This information is extremely important for driver and passenger safety, particularly that of babies and children.

SEAT recommends the use of child seats from the SEAT accessory programme. These child seats have been designed and tested for use in SEAT vehicles. You can purchase child seats with different mountings from a SEAT dealership.

#### **⚠ WARNING**

Make sure children are properly belted in and correctly secured to avoid severe or fatal injuries while the vehicle is in motion.

- Never use a rear-facing child seat in the front passenger seat if the front passenger front airbag is enabled.
- Children up to 12 years old should always travel on the rear seat.

- Children must always be protected with an approved child restraint system suited to their height and weight.
- Children must assume the proper sitting position and be properly belted in while travelling.
- Ensure the seat backrest is upright when a child seat is being used on it.
- Do not allow the child's head or other part of his or her body to enter the deployment area of the side airbags.
- Make sure the belt webbing is correctly positioned.
- Never hold children or babies on your lap or in your arms.
- Only one child may occupy a child seat.
- Please read and observe the child seat manufacturer's handling instructions.

#### **⚠ WARNING**

An empty or loose child seat could fly uncontrollably around the vehicle interior and cause injuries in the event of an accident or sudden braking.

- When not in use while the vehicle is in motion, always safely secure the child seat or store it in the luggage compartment.

#### **i Note**

Replace the child seat after an accident, as it may have invisible damage.

### Important information regarding the front passenger's airbag



**Fig. 18** Passenger's side sun visor: airbag sticker

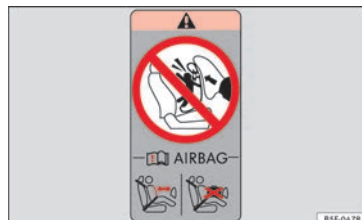

**Fig. 19** On the rear frame of the passenger side door: airbag sticker.

A sticker with important information about the passenger airbag is located on the passenger's sun visor and/or on the passenger side door frame. Read and always observe

the safety information included in the following chapters:

- Child seats and passenger side airbag  
»» **page 28, Use of the child seat on the front passenger seat.**
- Safety distance with respect to the passenger airbag »» **△ in Introduction on page 18.**
- Objects between the passenger and the passenger side airbag »» **△ in Front airbags on page 21.**

## General information on transporting children in the vehicle

Legal regulations and provisions will always take priority over the descriptions of this instruction manual. There are different regulations and provisions for the use of child seats and their mountings (» table on page 27). In some countries, for example, the use of child seats on certain seats in the vehicle may be forbidden.

The physical principles and the forces acting on the vehicle in the event of a collision or other type of accidents also apply to children » page 11. However, unlike adults and youngsters, children do not have fully developed muscle and bone structures. In the event of an accident, children are subject to a greater risk than adults of sustaining severe injuries.

Given that children's bodies are not yet fully developed, child restraint systems must be used that are especially adapted to their height, weight and constitution. There are laws in force in many countries that indicate

the use of approved seat systems for transporting babies and children.

Only used authorised, approved child seats that are suitable for the vehicle. Always consult with a SEAT dealership or a Specialised workshop should you have any doubts.

### Specific child seat regulations for each country (selection)

Child seats must comply with the ECE-R 44<sup>1)</sup> regulation. You can consult additional information at your SEAT dealership at the internet address [www.seat.es](http://www.seat.es).

### Categorisation of child seats according to ECE-R 44

Weight category	Weight of the child	Age
Group 0	up to 10 kg	up to approximately 9 months
Group 0+	up to 13 kg	up to approximately 18 months
Group 1	9 to 18 kg	approx. 8 months to 3½ years
Group 2	15 to 25 kg	approx. 3 to 7 years
Group 3	22 to 36 kg	approx. 6 to 12 years

Not all children fit in the seat of their weight group. Nor do all seats adapt to the vehicle. Therefore, always check whether the child fits properly in the child seat and whether the seat can be installed safely in the vehicle.

Child seats approved under the ECE-R 44 regulation are fitted with the corresponding approval symbol. The sign is an upper-case E in a circle with the identification number below it.

#### WARNING

**In general, the rear seat is always the safest place for children, who are belted correctly, in the event of an accident.**

- A suitable child seat that is correctly installed and used on one of the rear seats offer the most protection possible for babies and children up to 12 years in most accidents.

<sup>1)</sup> ECE-R: Economic Commission for Europe Regulation.

## Different mounting systems

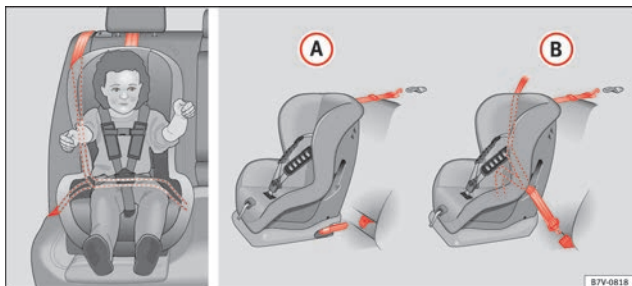

**Fig. 20** On the rear seats: Possible installations for the child seat.

Always secure child seats properly and safely in the vehicle according to the child seat manufacturer's installation instructions.

Mounted child seats must rest correctly on the vehicle's seat and must not move or rock more than 2.5 cm.

Child seats equipped for a Top Tether strap must also be secured using the Top Tether retaining strap in the vehicle » page 32. Attach the retaining strap to the corresponding retaining rings only. Not all rings can be used with the Top Tether system. Always tighten the Top Tether retaining strap so that the child seat fits snugly against the corresponding seat in the vehicle.

**Specific mounting systems for each country**  
Attachment variants » Fig. 20:

- (A)** Europe: ISOFIX retaining rings and upper retaining strap » page 31 and » page 32.
- (B)** Three-point seat belt and upper retaining strap » page 30.

**The systems include the child restraint system mounting with an upper retaining strap (Top Tether) and lower anchoring points on the seat.**

### Use of the child seat on the front passenger seat



Transporting children on the front passenger seat is not permitted in all countries. Furthermore, not all child seats are approved for use on the front passenger seat. Your SEAT deal-

ership has an updated list of all approved child seats. Only used child seats that are approved for each vehicle.

The front airbag on the front passenger side is highly dangerous for a child. The front passenger seat is life-threatening to a child if he or she is transported in a rear-facing child seat.

If a rear-facing child seat is secured to the front passenger seat, an inflating front airbag can strike it with such great force that severe or fatal injuries may result » **Δ**. Therefore, rear-facing child seats must **never** be placed on the front passenger seat when the front passenger front airbag is enabled.

Only use a rear-facing child seat on the front passenger seat if the front passenger front airbag is disabled. When it is disabled, the

yellow **PASSENGER AIR BAG OFF** ; »» page 17 control lamp on the dash panel will be lit. **If you cannot disable the front passenger front airbag and it remains activated, it is forbidden to transport children on the front passenger seat** »» .

### Things to note if using a child seat on the front passenger seat:

- The front passenger front airbag **must** be disabled  when using a rear-facing child seat »» page 17.
- The seat backrest of the front passenger seat must be upright.
- The front passenger seat must be moved as far back as possible.
- The seat backrest of the front passenger seat must be upright.

### Suitable child seats

The child seat must be authorised by the manufacturer especially for use on a front passenger seat with a front or side airbag.

**Universal seats for children** can be fitted in the front passenger seat, in groups 0, 0+, 1, 2 or 3 according to the ECE-R 44 regulation.

#### **WARNING**

**If a child seat is mounted on the front passenger seat, the risk of the child sustaining severe or fatal injuries in the event of an acci-**

**dent increases. Rear-facing child seats must never be mounted on the front passenger seat when the front passenger front airbag is enabled. This is life-threatening to the child should the front airbag deploy, as the child seat would be struck by the inflated airbag and thrown against the seat backrest.**

#### **WARNING**

**If, in exceptional circumstances, a child must be transported in a rear-facing child seat on the front passenger seat, strictly observe the following:**

- **Always disable the front passenger front airbag and leave it disabled.**
- **The child seat must be approved by the manufacturer for use on a front passenger seat with front and side airbag.**
- **Follow the installation instructions of the child seat manufacturer and observe the warnings.**
- **Move the front passenger seat as far back as possible and adjust it to its highest position to keep as far away as possible from the front airbag.**
- **Move the seat backrest to the upright position.**
- **Children must always be protected with an approved child restraint system suited to their height and weight.**

### Use of the child seat on the rear seat

If a child seat is mounted on the rear seat, adapt the position of the front passenger seat so that the child has enough space. Therefore, adapt the front passenger seat to the size of the child seat and the height of the child. Ensure the passenger is in the correct position  »» page 6.

### Suitable child seats

The manufacturer must authorise the child seat for use in the rear seats with side airbags.

**Universal seats for children** can be fitted in the passenger seat, in groups 0, 0+, 1, 2 or 3 according to the ECE-R 44 regulation.

The rear seats are suitable for child seats with the **ISOFIX system** specially designed for this type of vehicle in accordance with regulation ECE-R 44.

### ISOFIX child seats approved for rear seats

ISOFIX child seats are divided into the following certified categories: “universal”, “semi-universal” or “specific categories for the vehicle”.

- If the ISOFIX child seat is certified “universal”, it must be supported by the lower anchor points and the Top Tether retaining strap.

- If the ISOFIX child seat is certified “semi-universal” or “specific categories for the vehicle”, check that the child seat is certified for the vehicle before employing it. The child seat manufacturer supplies, in addition to the ISOFIX child seat, a list of vehicles for which the corresponding ISOFIX child seat has been certified. If necessary, contact the child seat manufacturer for an updated list of vehicles.

### Securing child seats with the seat belt

The seat belt may be used to secure child seats with the **universal** marking (on the orange label) to the vehicle seats marked with a **u** in the table below.

Category	Front passenger	Rear seats
<b>Group 0</b> Up to 10 kg	u	u
<b>Category 0+</b> Up to 13 kg	u	u
<b>Group 1</b> 9 to 18 kg	u	u

Category	Front passenger	Rear seats
<b>Group 2</b> 15 to 25 kg	u	u
<b>Group 3</b> 22 to 36 kg	u	u

### Securing the child seat using the seat belt

- Please read and observe the child seat manufacturer's handling instructions.
- Move the front passenger seat, or the rear seat bench back as far as possible and, in the case of an adjustable backrest, set it in the upright position »» page 6.
- Positioning the child seat on the seat according to the manufacturer's instructions.
- Fasten the seat belt or pass it around the child seat structure in the manner described in the manufacturer's instructions.
- Make sure the seat belt is not twisted.
- Insert the latch plate into the buckle for the appropriate seat and push it down until it is securely locked with an audible click.
- Ensure that the upper belt web lies tightly on the child seat.

- Pull the belt (it must be no longer possible to pull the lower belt webbing out).

### Removing the child seat

The seat belt must not be unfastened until the vehicle has come to a standstill »» .

- Press the red button on the buckle. The latch plate is released from the buckle.
- Guide the belt back by hand so that it rolls up easily and the trim will not be damaged.
- Remove the child seat from the vehicle.

#### WARNING

**Unbuckling the seat belt while the vehicle is in motion can cause severe or fatal injuries in the event of an accident or sudden braking.**

- **The seat belt must not be unfastened until the vehicle has come to a standstill.**

## Fix the child seat with the lower anchor points (ISOFIX)

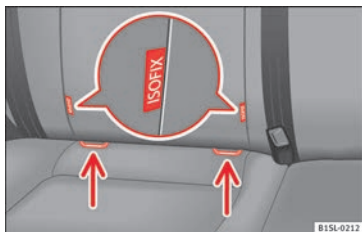

**Fig. 21** On the vehicle seat: identification variants of the anchor points for the child seats

Each seat of the rear seat bench has **two** retainers named lower anchor points.

### Overview of ISOFIX installation

In compliance with European directive ECE 16, The following table details the installation possibilities for ISOFIX child seats with the lower anchor points in each of the vehicle seats.

The permitted body weight for the child seat or information regarding size **A** to **G** is indica-

ted on the label on the child seat with “universal” or “semi-universal” certification.

	Group (weight category)									
	Group 0: up to 10 kg		Group 0: up to 10 kg			Group 1: 9 to 18 kg				
			Group 0+: up to 13 kg							
Installation direction	facing backwards (in the direction opposite to travel)		facing backwards (in the direction opposite to travel)			facing backwards (in the direction opposite to travel)		facing forwards (in the direction of travel)		
Size	F	G	C	D	E	C	D	A	B	B1
installed on front passenger seat	Seat does not have anchor points, ISOFIX securing is not possible									
Installed on the rear seat bench	IL-SU		IL-SU			IL-SU		IUF/IL-SU		

**IL-SU:** seat suitable for installing an ISOFIX child seat with certification “semi-universal”, take note of the list of vehicles of the manufacturer of the child seat.

**IUF:** seat suitable for the installation of an ISOFIX child seat with certification “universal” and with Top Tether retaining strap.

### Child seats with rigid mounting

For the installation of a child seat with rigid mounting auxiliary introduction elements can ➤

be used. Using auxiliary introduction elements facilitates installation and protects upholstery. Auxiliary introduction elements form part of the supply volume of the child seat or can be acquired at a SEAT dealership. If necessary, auxiliary introduction elements are inserted in both anchor points of the vehicle »» ⓘ.

- Observe the manufacturer's instructions when installing and removing the child seat »» ⚠.
- Press the child seat onto the retaining rings »» Fig. 21 in the direction of the arrow. The child seat must be safely engaged and click audibly into place.
- Pull on both sides of the child seat to ensure that it is secure.

#### Child seat with adjustable retaining straps

- Observe the manufacturer's instructions when installing and removing the child seat »» ⚠.
- Place the child seat on the seat cushion and attach the retaining strap hooks to the retaining rings »» Fig. 21.
- Tighten the straps evenly using the corresponding adjustment device. The child seat must sit flush against the vehicle seat.
- Pull on both sides of the child seat to ensure that it is secure.

#### ⚠ WARNING

The lower anchor points for child seats do not include rings. Only secure booster seats to lower anchor points.

#### ⓘ CAUTION

- To avoid making permanent marks in the padding, remove the auxiliary introduction elements from the anchor points when the child seat is not installed in the vehicle anchor points.
- To prevent damage being done to the upholstery, the padding or the auxiliary introduction elements, always remove the auxiliary introduction elements from the anchor points before folding the rear seat bench.

#### Securing a child seat using a Top Tether retaining strap



Fig. 22 Example of an upper retaining strap connected.

- Observe the manufacturer's instructions when installing and removing the child seat »» ⚠.
- Unlock the seat backrest and fold it gently forward »» page 64.
- Remove the head restraints situated behind the child seat and store them safely in the vehicle »» page 6.
- Guide the upper retaining strap from the child seat back to the luggage compartment, feeding it through the seat backrest and the rear shelf.
- Fold back the seat backrest and push it firmly into the lock.
- Secure the child seat to the lower anchor points »» page 31

- Hook the upper retaining strap in the luggage compartment, to the corresponding retaining ring »» Fig. 22.
- Tighten the strap so that the top of the child seat rests on the seat backrest.

**⚠ WARNING**

Child seats with lower anchor points and with an upper retaining strap must be installed in line with the manufacturer's instructions. Failure to comply could result in severe injuries.

- Always secure just *one* retaining strap to a child seat with the luggage compartment retaining ring.
- Always use the correct retaining rings for the retaining strap.
- Never secure the retaining strap to a retainer.

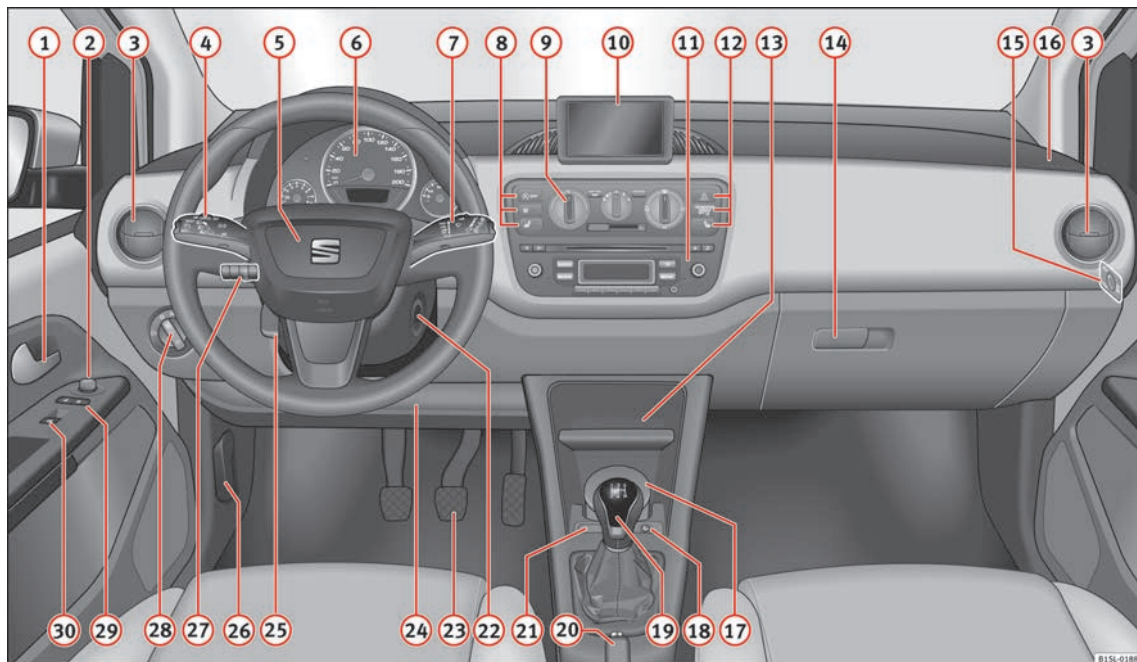

**Fig. 23** Dash panel













815L-0188

# Operation

## Cockpit

### Overview

Legend for the **Fig. 23:**

① Interior door release lever .....	49	– Lever with buttons for controlling the SEAT information system <b>TRIP- , OK/RESET</b> .....	40	⑮ In the side of the dash panel: Key switch for switching off the front passenger airbag <sup>1)</sup> .....	17
② Turn switch for adjusting the exterior mirrors .....	61	⑧ Controls for:		⑯ Position of passenger front airbag on the dash panel .....	17
– Exterior mirror adjustment <b>L - 0 - R</b>		– Start-Stop system button (A) <sup>OFF</sup> ...	115	⑰ Ashtray* .....	71
– Heated exterior mirrors 		– Rear window heating button 	80	⑱ 12 volt socket or cigarette lighter* .72, 72	
③ Air outlets .....	80	– Left seat heating controls 	64	⑲ Lever for:	
④ Lever for .....	55	⑨ Switches for:		– Manual gearbox .....	94
– Turn signals  and main beam headlights 		– Heating and ventilation system .	80	– Automatic gearbox .....	95
– Cruise control system (CCS) <b>ON - CANCEL - OFF - RES/+ - SET/-</b> .....	107	– Air conditioner .....	80	⑳ Handbrake .....	89
⑤ Steering wheel with horn and		⑩ SEAT Portable System (supplied by SEAT) .....	123	㉑ Button for:	
– Driver airbag .....	21	⑪ Radio (factory fitted) <b>»» Booklet Radio</b>		– City Safety Assist function  <b>OFF</b> .	110
⑥ Dash panel .....	36, 39	⑫ Controls for:		㉒ Ignition lock .....	86
⑦ Windscreen wiper/ windscreen wash lever .....	60	– Hazard warning lights switch 	170	㉓ Pedals .....	93
– Windscreen wipers		– Passenger front airbag off warning lamp <b>PASSENGER AIR BAG OFF</b> 	17	㉔ Storage compartment .....	67
– Rear window wiper		– Right seat heating controls  or rear window heating button 	64, 80	㉕ Steering column adjustment lever .	6
		(alternative position) .....	64, 80	㉖ Open bonnet lever .....	143
		⑬ Storage compartment with drink holder in the centre console .....	71	㉗ Headlamp range adjustment 	55
		⑭ Handle of the storage compartment or storage compartment open <sup>1)</sup> ...	67	㉘ Light switch 	55
				㉙ Central lock button  -	45
				㉚ Button for operating the electric windows of the driver door	52

<sup>1)</sup> According to version

## Instruments

### Detail of instrument panel



Fig. 24 Instrument panel, on dash panel: variant 1.



Fig. 25 Instrument panel, on dash panel: variant 2.

Details of the instruments »» Fig. 24 or »» Fig. 25:

- 1 **Speedometer.** Depending on the vehicle in km/h or in mph.
- 2 **Displays on the screen.** ..... 37
- 3 **Reset knob** for trip recorder (trip).
  - Press the button **[0.0/SET]** *briefly* to switch the trip odometer and odometer.
  - Press the **[0.0/SET]** for 5 seconds to reset the odometer to zero and, where necessary, other indicators on the multifunction display. .... 40
- 4 **Fuel reserve display.** ..... 139
- 5 **Rev counter** (with the engine running, in thousands of revolutions per minute).

The beginning of the red zone of the rev counter indicates the maximum speed in any gear after running-in and with the engine hot. However, it is advisable to change up a gear or move the selector lever to **D** (or lift your foot off the accelerator) before the needle reaches the red zone »» !.

- 6 **Clock set button.**
  - If necessary, change the time display by pressing the top and bottom buttons of the rocker switch »» Fig. 26 (B).
  - Press the button **[⏸]** to change the hour, so that it is flashing.

- To continue setting the time, press button **[0.0/SET]**. Hold button down to scroll through the numbers quickly.
- Press the **[⏸]** button again to change the minutes, so that it flashes.
- To continue setting the time, press button **[0.0/SET]**. Hold button down to scroll through the numbers quickly.
- Press button **[⏸]** again to end the clock setting.

#### ⓘ CAUTION

- When the engine is cold, avoid high revs and heavy acceleration and do not make the engine work hard.
- To prevent damage to the engine, the rev counter needle should only remain in the red zone for a short period of time.

#### 🌿 For the sake of the environment

Changing up a gear in time reduces fuel consumption and noise.

#### 📄 Note

On the screen of the SEAT Portable System (supplied by SEAT) »» page 123 other instruments can be viewed, such as an outside temperature gauge.

## Display messages



A variety of information can be viewed on the instrument panel display » **Fig. 24** and » **Fig. 25** (2), depending on the vehicle equipment:

- Warning and information messages.
- Odometer.
- Time.
- Outside temperature.
- Selector lever positions » **page 93**.
- Recommended gear (manual gearbox) » **page 93**.
- Multifunction display (MFI) » **page 40**
- Service interval display » **page 38**.
- Start-Stop system status display » **page 115**.
- Fuel gauge » **page 139**.
- Seat belt status display for rear seats » **page 11**.

### Warning and information messages

The system runs a check on certain components and functions when the ignition is switched on and while the vehicle is moving. Faults in the operation are displayed on the screen using red and yellow symbols on the instrument panel display (» **page 39**) and, in some cases, with audible warnings. The

display may vary according to the type of instrument panel fitted.



Type of message	Symbol colour	Description
Priority 1 warning.	Red	Symbol flashing or lit; partly combined with audible warnings.  <b>Stop the vehicle!</b> It is dangerous »  ! Check the function that is faulty and repair it. If necessary, request assistance from specialised personnel.
Priority 2 warning.	Yellow	Symbol flashing or lit; partly combined with audible warnings. A faulty function, or fluids which are below the correct levels may cause damage to the vehicle! »  ! Check the faulty function as soon as possible. If necessary, request assistance from specialised personnel.

### Odometer

The *odometer* registers the total distance travelled by the car.

The *odometer* (trip) shows the distance travelled since the last odometer reset. The last figure indicates 100 m.

### Outside temperature indicator

When the outside temperature is below +4 °C (+39 °F), the symbol “ice crystal” (warning of risk of freezing) is also displayed next to the temperature. At first this symbol flashes and then it remains lit until the outside temperature rises above +6 °C (+43 °F) »  .

When the vehicle is stationary or travelling at very low speeds, the temperature displayed may be slightly higher than the actual outside temperature as a result of heat coming from the engine.

The temperatures measured range from -40 °C to +50 °C (-40 °F to +122 °F).

### Selector lever positions

The range of engaged gears of the selector lever is shown on the side of the lever, and on the instrument panel display. In positions **D** and **M**, and with the Tiptronic, the corresponding gear is also indicated on the display.

### Recommended gear\* (manual gearbox)

The recommended gear to save fuel can be displayed on the instrument panel display while you are driving » **page 93**.

### Seat belt status display for rear seats\*

The seat belt status display on the instrument panel display informs the driver, when the ignition is switched on, whether any

passengers in the rear seats have fastened their seat belts » page 11.

### Start-Stop system status display

The instrument panel display shows information on the current status » page 115.

#### WARNING

If the warning lamps are ignored, the vehicle may stall in traffic, or may cause accidents and severe injuries.

- Never ignore the warning lamps.
- Stop the vehicle safely as soon as possible.
- A faulty vehicle represents a risk of accident for the driver and for other road users. If necessary, switch on the hazard warning lamps and put out the warning triangle to advise other drivers.
- Park the vehicle away from traffic and ensure that no highly flammable materials are under the vehicle that could come into contact with the exhaust system (e.g. dry grass, fuel).

#### WARNING

Even though outside temperatures are above freezing, some roads and bridges may be icy.

- At outside temperatures above +4°C (+39°F), even when the “ice crystal symbol” is not visible, there may still be patches of ice on the road.

- **Never rely on the outside temperature indicator!**

#### CAUTION

Failure to heed the warning lamps when they appear may result in faults in the vehicle.

#### Note

- Different versions of the instrument panel are available and therefore the versions and instructions on the display may vary.
- When several warnings are active at the same time, the symbols are shown successively for a few seconds and will stay on until the fault is rectified.

### Service interval display

The inspection display appears on the instrument panel display » Fig. 24 or » Fig. 25 (2).

SEAT makes a difference between services *with* engine oil change (Interval Service) and services *without* engine oil change (Inspection Service). The service interval display only gives information for service dates which involve an engine oil change. The dates of the remaining services (e.g. the next Inspection Service or change of brake fluid) are listed on the label attached to the door strut, or in the Maintenance Programme.

The set service intervals have been specified with the **service dependent on time/distance travelled**.

### Inspection reminder

If the inspection period is due to expire shortly, **Inspection reminder** appears when starting the ignition abbreviated to **InSP** and a warning in **km**. The number of kilometres shown is the maximum number that may be driven until the next service.

### Service due

After the **service date**, an audible warning is given when the ignition is switched on and the abbreviation **InSP** displayed on the screen flashes for a few seconds.

#### Note

The service message disappears after a few seconds, when the engine is started or when  is pressed on the windscreen wiper lever.

#### Note





In vehicles in which the battery has been disconnected for a long period of time, it is not possible to calculate the date of the next service. Therefore the service interval display may not be correct. In this case, bear in mind the maximum service intervals permitted in the » Booklet Maintenance Programme.







## Control lamps









### Control and warning lamps













The control and warning lamps are indicators of warnings, **»** **▲**, faults **»** **!** or certain functions. Some control and warning lamps come on when the ignition is switched on, and switch off when the engine starts running, or while driving.

When certain control and warning lamps are lit, an audible warning is also heard.

Symbol	Meaning <b>»</b> <b>▲</b>	See
	Handbrake applied.	
	<b>»</b> <b>Do not continue driving!</b> The brake fluid level is too low or there is a fault in the brake system.	<b>»</b> page 89
	<i>it lights up:</i> <b>»</b> <b>Do not continue driving!</b> The liquid coolant level is too low, the engine liquid coolant temperature is too high or there is a fault in the liquid coolant system.  <i>flashes:</i> engine coolant system faulty.	<b>»</b> page 150  <b>»</b> page 150
	<b>»</b> <b>Do not continue driving!</b> Engine oil pressure too low.	<b>»</b> page 146

Symbol	Meaning <b>»</b> <b>▲</b>	See
	<i>lights up or flashes:</i> <b>»</b> <b>Do not continue driving!</b> Fault in the steering.	<b>»</b> page 84
	On the instrument panel: driver or passenger has not fastened seat belt.	<b>»</b> page 11
	Instrument panel display: a passenger in the rear seats has fastened their seatbelt.	
	A passenger in the rear seats has not fastened their seat belt.	<b>»</b> page 11
	Faulty generator.	<b>»</b> page 154
	Vehicles with the Start-Stop system: it is necessary to start the engine manually.	<b>»</b> page 115
	<i>flashes in addition to the rest of the segments of the fuel gauge:</i> Fuel tank almost empty.	<b>»</b> page 139

Symbol	Meaning <b>»</b> <b>▲</b>	See
	<i>flashes quickly:</i> the City Safety Assist system function* brakes automatically or has braked automatically. <b>Or:</b> <i>flashes slowly:</i> City Safety Assist function is not currently available.	<b>»</b> page 110
	<b>On</b> The City Safety Assist* function has been connected manually. It switches off after 5 seconds.	
	<b>OFF</b> <i>flashes:</i> The City Safety Assist* function has been manually disconnected.	
	after the ignition is switched on: indication that the end of the period for an inspection to be performed is approaching.	<b>»</b> page 36
	<i>it lights up:</i> ESC* faulty or disconnected by the system. <b>ALTERNATIVELY:</b> <i>flashes:</i> ESC* or ASR regulating.	
	<i>it lights up:</i> Traction Control faulty or switched off by the system. <b>ALTERNATIVELY:</b> <i>flashes:</i> Traction Control regulator operating.	<b>»</b> page 89
	ABS faulty or does not work.	
	Rear fog light switched on.	<b>»</b> page 55

Symbol	Meaning » 	See
	<i>lights up or flashes:</i> fault in catalytic converter.	» page 101
<b>EPC</b>	Fault in engine management.	
	<i>lights up or flashes:</i> fault in the steering system.	» page 84
	Fuel tank almost empty.	» page 139
	Fault in airbag system and seat belt tensioners.	» page 17
	<i>it lights up:</i> the Start-Stop system is enabled. <b>ALTERNATIVELY:</b> <i>flashes:</i> the Start-Stop system is not available.	» page 115
	The Start-Stop system is enabled but the engine cannot be automatically stopped.	
	Tyre pressure* too low	» page 164
	Left or right turn signal.	» page 55
	Hazard warning lights on.	» page 170
	Cruise control operating.	» page 107
	Main beam on or flasher on.	» page 55
	The natural gas engine coolant temperature is too low.	

## WARNING

If the warning lamps are ignored, the vehicle may stall in traffic, or may cause accidents and severe injuries.

- Never ignore the warning lamps.
- Stop the vehicle safely as soon as possible.
- Park the vehicle away from traffic and ensure that there are no highly flammable materials under the vehicle that could come into contact with the exhaust system (e.g. dry grass, fuel).
- A faulty vehicle represents a risk of accident for the driver and for other road users. If necessary, switch on the hazard warning lamps and put out the warning triangle to advise other drivers.
- Before opening the bonnet, switch off the engine and allow it to cool.
- In any vehicle, the engine compartment is a hazardous area and could cause severe injuries » page 143.

## CAUTION

Failure to heed the warning lamps when they appear may result in faults in the vehicle.

## SEAT information system

### Introduction

With the ignition switched on it is possible to access different messages via the display on the instrument panel display.

The number of messages displayed on the instrument panel display will vary according to the vehicle electronics and equipment.

A specialised workshop will be able to programme or modify additional functions, according to the vehicle equipment. SEAT recommends taking your car in for technical service.

## WARNING

Any distraction may lead to an accident, with the risk of injury.

- Do not consult the messages on the instrument panel screen when driving.

## Note

On the screen of the SEAT Portable System (supplied by SEAT) » page 123 other functions of the vehicle can be seen.

## Control functions of the instrument panel display

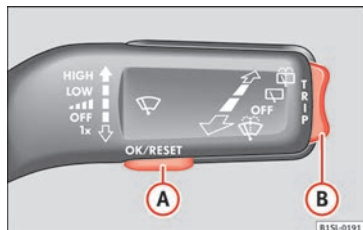

**Fig. 26** Windscreen wiper lever: control buttons.

### Calling up options

- Switch the ignition on.
- If a message or vehicle symbol is displayed, press **OK/RESET** (» **Fig. 26 A**).
- Press the top or bottom part of the rocker switch » **Fig. 26 B** until the desired option appears.

## Multifunction display (MFI)

The multifunction display (MFI) has two automatic memories: **1 - Partial memory** and **2 - Total memory**. The selected memory will be shown in the lower right-hand corner of the display.

With the ignition switched on, and memory 1 or 2 displayed, briefly press **OK** to change from one memory to another.

1	Trip memory (for a single journey).	The memory stores the values for the journey and the consumption from the moment the ignition is switched on until it is switched off again. If the journey is broken for more than 2 hours, the memory is automatically erased. If the journey is continued in less than 2 hours after the ignition is switched off, the new data is added to the data already stored in the memory.
2	Total memory (for all journeys).	The memory stores the values of any number of journeys, until it counts a total of 19 hours and 59 minutes of driving, or 1999.9 km or miles of driving, depending on the type of instrument panel fitted. On reaching either of these limits, the memory is automatically erased and starts to count from 0 again.

### Possible displays

Menu	Function
Time	Current time in hours (h) and minutes (min).
Journey duration	This indicates the hours (h) and minutes (min) since the ignition was switched on.

Menu	Function
Current fuel consumption	The current fuel consumption display operates throughout the journey, in l/100 km; with the engine running and the vehicle stopped, in l/hour.
Average fuel consumption	After turning on the ignition, average fuel consumption in litres/100 km will be displayed after travelling about 100 metres. Otherwise horizontal lines are displayed. The value shown is updated approximately every 5 seconds.
Operating range	Approximate distance in km that can still be travelled with the fuel remaining in the tank, assuming the same style of driving is maintained. This is calculated using the current fuel consumption.
Distance covered	Distance travelled, after ignition is switched on, in km.
Average speed	The average speed will be shown after a distance of about 100 metres has been travelled. Otherwise horizontal lines are displayed. The value shown is updated approximately every 5 seconds.
Digital display of speed	Current speed displayed digitally.
Liquid coolant temperature digital display	Digital display of the current temperature of the engine liquid coolant.

Menu	Function
Warning at --- km/h	If the stored speed is exceeded (between 30 - 250 km/h, or 18 - 155 mph), an audible warning is given together with a visual warning.

 Note

On the screen of the SEAT Portable System (supplied by SEAT) » page 123 other functions of the multifunction display can be seen.

### Changing between display modes

- Press the rocker switch in the windscreen wiper lever.

### Storing a speed for the speed warning

- Select the display **Speed warning at --- km/h**.
- Press **OK** on the windscreen wiper lever to store the current speed and switch off the warning.
- In addition, set the required speed by pressing the rocker switch on the windscreen wiper lever or **▲** or **▼** buttons on the multifunction steering wheel for 5 seconds. Next, press **OK** again or wait a few seconds. The speed is stored and the warning activated.
- *To switch off*, press **OK**. The stored speed is deleted.

### Manually erasing memory 1 or 2

- Select the memory to be erased.
- Press and hold the eject button **OK** for approximately 2 seconds.

## Opening and closing

### Vehicle key set

#### Remote control vehicle key\*



Fig. 27 Remote control key

#### Remote control key

With the vehicle key the vehicle may be locked or unlocked remotely » page 45.

The vehicle key includes an emitter and battery. The receiver is in the interior of the vehicle. The range of the vehicle key with remote control and new battery is several metres around the vehicle.

If it is not possible to open or close the vehicle using the remote control key, this should be re-synchronised » page 45 or the battery changed » page 44.

Different keys belonging to the vehicle may be used.

#### Folding the key shaft in and out

When the button is pressed » Fig. 27 (A), the key shaft is released and unfolds.

To *fold it* press the button and fold the key shaft in until it locks in place.

#### Replacing a key

To obtain a spare key and other vehicle keys, the vehicle chassis number is required.

Each new key must contain a microchip and be coded with the data from the vehicle electronic immobiliser. A vehicle key will not work if it does not contain a microchip or the microchip has not been encoded. This is also true for keys cut for the vehicle.

The vehicle keys or new spare keys can be obtained from a SEAT dealership, a Specialised workshop or approved key service qualified to create this kind of key.

New keys or spare keys must be synchronised before use » page 45.

#### **⚠ WARNING**

**Careless or incorrect use of vehicle keys may result in severe injury and accident.**

- Always take all the keys with you whenever you leave the vehicle. Children and unauthorised individuals could lock the doors or the

boot hatch, start the engine or turn on the ignition, activating electrical systems, the electric windows, for example.

- Never leave children or disabled people alone in the car. They could be trapped in the car in an emergency and will not be able to get themselves to safety. For example, depending on the time of the year, temperatures inside a locked and closed vehicle can be extremely high or extremely low resulting in serious injuries and illness or even death, particularly for young children.
- Never remove the key from the ignition if the vehicle is in motion. The steering may lock and it will not be possible to turn the steering wheel.

#### **ⓘ CAUTION**

**The remote control key contains electronic components. Protect them from damage, impacts and humidity.**

#### **i Note**

- Only use the key button when you require the corresponding function. Pushing the button unnecessarily could accidentally unlock the vehicle or trigger the alarm. It is also possible even when you are outside the radius of action.
- Remote control key operation can be greatly influenced by overlapping radio signals around the vehicle working in the same range »

of frequencies (for example, radio transmitters, mobile telephones).

- Obstacles between the remote control and the vehicle, bad weather conditions and draining batteries can considerably reduce the range of the remote control.

- If the buttons of the vehicle key are pressed » Fig. 27 or one of the central locking buttons » page 45 is pressed repeatedly in quick succession, the central locking briefly disconnects as protection against overloading. The vehicle is then unlocked. Lock it if necessary.

### Vehicle mechanical key

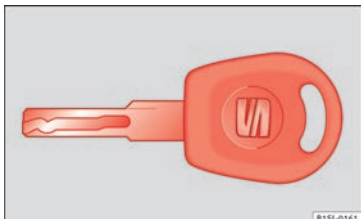

Fig. 28 Vehicle mechanical key

The vehicle key set may include a mechanical key » Fig. 28.

### Duplicate keys

To obtain a spare key and other vehicle keys, the vehicle chassis number is required.

Each new key must contain a microchip and be coded with the data from the vehicle electronic immobiliser. A vehicle key will not work if it does not contain a microchip or the microchip has not been encoded. This is also true for keys cut for the vehicle.

The vehicle keys or new spare keys can be obtained from a SEAT dealership, a specialised workshop or an approved locksmith qualified to create them.

### Control lamp on the vehicle key

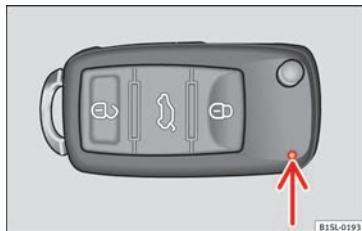

Fig. 29 Control lamp on the vehicle key

When a button on the vehicle key is pressed, the control lamp flashes » Fig. 29 (arrow) once briefly. If the button is pressed and held, the indicator blinks several times, for

example: for the convenience opening function.

When the control lamp does not light upon pushing a button, the vehicle key batteries must be changed » page 44.

### Changing the battery

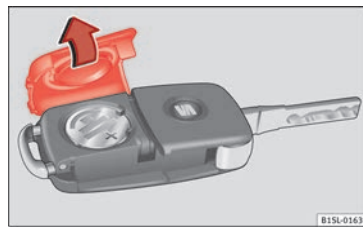

Fig. 30 Vehicle key: battery compartment cover

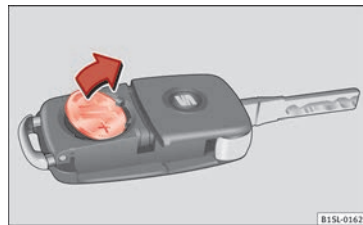

Fig. 31 Vehicle key: removing the battery

SEAT recommend having the batteries changed in a specialised workshop.

The battery is located to the rear of the vehicle key, under a cover.

### Changing the battery

- Unfold the vehicle key shaft » page 43.
- Remove the cover from the back of the vehicle key » Fig. 30 in the direction of the arrow » ①.
- Extract the battery from the compartment using a suitable thin object » Fig. 31.
- Place the new battery in the compartment, pressing in the direction of the arrow as shown » Fig. 31 » ①.
- Fit the battery compartment cover, pressing in the direction of the arrow as shown » Fig. 30 until it clicks into place.

#### ⓘ CAUTION

- If the battery is not changed correctly, the vehicle key may be damaged.
- Use of unsuitable batteries may damage the vehicle key. For this reason, always replace the dead battery with another of the same voltage, size and specifications.
- When fitting the battery, check that the polarity is correct.



For the sake of the environment

Please dispose of your used batteries correctly and with respect for the environment.

### Synchronising the vehicle key

If the button  is pressed frequently outside of the vehicle range, it is possible that the vehicle can no longer be locked or unlocked using the key. In this case, the vehicle key must be synchronised once more as follows:

- Unfold the vehicle key shaft » page 43.
- Press the button  on the vehicle key. For this, it must remain with the vehicle.
- Open the vehicle within one minute using the key shaft.
- Turn on the ignition using the vehicle key. The key has been synchronised.
- If necessary, fit the cap.

## Central locking\* and locking system

### Introduction

Central locking functions correctly when all the doors and the rear lid are correctly shut.

If the driver door is open, the vehicle *cannot* be locked with the key.

The battery of an unlocked vehicle parked for a long period (e.g. in a private garage) may run down and fail to start the motor.

#### ⚠ WARNING

The incorrect use of the central locking system may cause serious injuries.

- The central locking system will lock all doors. A vehicle locked from the inside can prevent any non-authorized individual from opening the doors and accessing the vehicle. Nevertheless, in case of emergency or accident, locked doors will complicate access to the vehicle interior to help the passengers.
- Never leave children or disabled people alone in the vehicle. The central locking button can be used to lock all the doors from within. Therefore, passengers will be locked inside the vehicle. Individuals locked in the vehicle can be exposed to very high or very low temperatures.
- Depending on the time of the year, temperatures inside a locked and closed vehicle can be extremely high or extremely low resulting in serious injuries and illness or even death, particularly for young children.
- Never leave individuals locked in a closed and locked vehicle. In case of emergency, they may not be able to exit the vehicle by themselves or get help.

### Description of the central locking system

The central locking system allows all doors and the rear lid to be locked and unlocked centrally.

- From outside, using the vehicle key.
- From inside, by pushing the central locking button » page 48.

The central locking system can be activated or deactivated at a specialised workshop.

In case of a vehicle key fault or central locking system fault, all doors can be locked or unlocked manually.

#### Locking the vehicle after the airbags have been deployed

If the airbags are deployed due to an accident, the vehicle will be automatically and completely unlocked. Depending on the amount of damage, it can be locked following an accident in the following ways:

Function	Necessary operations
Lock the vehicle, by pushing the central locking button:	<ul style="list-style-type: none"> <li>– Turn off the ignition and turn it on again.</li> <li>– Push the central locking button .</li> </ul>

Function	Necessary operations
Use the key to lock the vehicle:	<ul style="list-style-type: none"> <li>– Turn off the ignition and turn it on again.</li> <li>OR: Remove the key from the ignition.</li> <li>– Open any door just once.</li> <li>– Lock the vehicle with the key.</li> </ul>

#### Note

**If the buttons of the vehicle key are pressed » page 43 or one of the central locking buttons » Fig. 34 is pressed repeatedly in short succession, the central locking briefly disconnects as protection against overloading. In this case, the vehicle remains unlocked for about 30 seconds. If neither the door or the boot is opened during this time, the vehicle will then automatically lock.**

### Locking and unlocking the vehicle from the exterior





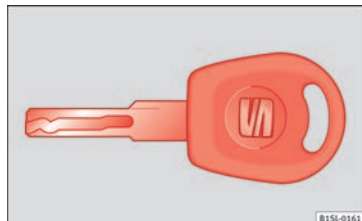

**Fig. 32** Buttons on the vehicle key



**Fig. 33** Vehicle mechanical key

## Central locking

Function	Handling the buttons on the vehicle » Fig. 32	Handling the vehicle key » Fig. 32 in the lock cylinder or with the vehicle mechanical key » Fig. 33.
Unlocking the vehicle.	Press button 	Insert the vehicle key into the lock cylinder of the driver door and turn the key <b>in an anticlockwise direction</b> .
Lock the vehicle.	Press button 	Insert the vehicle key into the lock cylinder of the driver door and turn the key <b>in a clockwise direction</b> .
Unlocking the rear lid.	Press button 	Insert the vehicle key into the lock cylinder of the driver door and turn the key <b>in an anticlockwise direction</b> .
Locking the rear lid.	Press button 	Insert the vehicle key into the lock cylinder of the driver door and turn the key <b>in a clockwise direction</b> .

**Please note:** depending on the operation of the central locking feature set by a specialised workshop, in order to unlock all the doors and the rear lid, press the button  twice.

The vehicle key only locks and unlocks the vehicle if it is within range of the vehicle and if the battery has enough power.

- Upon locking the vehicle, all turn signals will flash *once* in confirmation.
- Upon unlocking the vehicle, all turn signals will flash *twice* in confirmation.

If the turn signals *do not* flash in confirmation, at least one of the doors or the rear lid has been left unlocked.

If the driver door is open, the vehicle cannot be locked with the key. If you unlock the vehicle without opening any doors or the rear lid, it will lock again automatically after a few seconds. This function prevents the vehicle from remaining unlocked if the unlocking button is pressed by mistake.

## Mechanical locking

Function	Using the vehicle's mechanical key » Fig. 33 in the lock cylinder
Locking the driver door manually.	To <i>unlock</i> , insert the vehicle key into the lock cylinder of the driver door and turn the key <b>in an anticlockwise direction</b> .
	To <i>lock</i> , insert the vehicle key into the lock cylinder of the driver door and turn the key <b>in a clockwise direction</b> .

Function	Using the vehicle's mechanical key » Fig. 33 in the lock cylinder
Locking and unlocking the rear lid.	To <i>unlock</i> , insert the vehicle key into the lock cylinder of the driver door and turn the key <b>in an anticlockwise direction</b> .
	To <i>lock</i> , insert the vehicle key into the lock cylinder of the driver door and turn the key <b>in a clockwise direction</b> .

If the driver's door is open, it cannot be locked with the vehicle key.

## Locking and unlocking the vehicle from the inside



**Fig. 34** In the driver door: central locking button

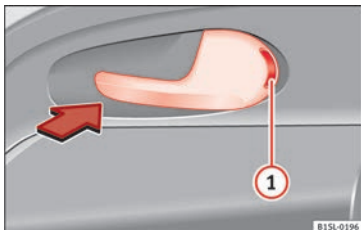

**Fig. 35** In the passenger door: door handle for mechanical locking.

## Central locking

Push the button » **Fig. 34:**

- |  |                        |
|--|------------------------|
|  | Unlocking the vehicle. |
|  | Lock the vehicle.      |

The central locking button is still operative when the ignition is switched off.

If the vehicle has been locked with the vehicle key, the central locking button does not operate.

Please note the following when you use the central locking button to lock your vehicle:

- The "Safe" security system **will not** activate » **page 48**.
- It will not be possible to open the doors or the rear lid from the *outside* this may offer extra safety, when stopped at traffic lights for example.
- The doors can be opened and unlocked individually from the inside by pulling the inside door handle. If necessary, pull the door release lever twice.
- The driver door cannot be locked when open. This avoids locking the vehicle key inside the vehicle when there is nobody inside.

## Mechanical locking

The doors are locked by pressing the door lever, so that the red mark becomes visible » **Fig. 35 ①**.

To unlock a door, pull its corresponding door lever.



If the vehicle becomes locked, take note of the following:

- The "Safe" security system **will not** activate » **page 48**.
- It will not be possible to open the doors from the *outside*, when stopped at traffic lights for example.
- The doors can be opened and unlocked individually from the inside by pulling the inside door handle.
- The driver door cannot be locked using the central locking system when it is still open. This avoids locking the vehicle key inside the vehicle when there is nobody inside.

## "Safe" security system\*

Function	Necessary operations
Locks the vehicle with the "Safe" security system.	Press the  button <i>once</i> on the vehicle key.

## Opening and closing

Function	Necessary operations
Locks the vehicle without the "Safe" security system.	Press the  button <i>twice</i> on the vehicle key.
	Press the central locking button  on the driver door once.

When the vehicle is locked, the "Safe" security system deactivates the door handles, making the vehicle difficult to open. The doors cannot be opened from inside .

Upon switching off the ignition, the instrument panel display will show that the "deadlock" is activated or (SAFELOCK or SAFELOCK).

### When the deadlock is switched off:

- The vehicle can be opened and unlocked from the inside using an inside door handle.

### Control lamp on the driver door

When the vehicle is locked:	Meaning
The red LED flashes for approximately 2 seconds at short intervals and then more slowly.	The "Safe" security system is switched on.
The red LED flashes for about two seconds then turns off. After 30 seconds, the LED flashes again.	The "Safe" security system is switched off.

When the vehicle is locked:	Meaning
The red LED flashes for about two seconds at short intervals. Subsequently, the light will remain switched on for about 30 seconds.	There is a fault in the locking system. Contact a specialised workshop.

### WARNING

Careless use of the "Safe" security system can cause serious injury.

- Never leave anybody inside the vehicle if it has been locked using the key. When the "Safe" security system is activated, doors cannot be opened from the inside!
- When the doors are locked, it is difficult to get to passengers in the vehicle interior in case of an emergency. Passengers could remain trapped inside and unable to unlock the doors in case of an emergency.

## Doors

### Introduction

### WARNING

If a door is not correctly closed, it could open unexpectedly when driving and cause serious injuries.

- Always stop immediately and close the door.

• When closing, ensure that the door has closed correctly. A closed door should be flush with the corresponding parts of the bodywork.

- Open and close doors only when nobody is in the way of the door.

### WARNING

A door held open by its retainer could be blown closed by the wind or close if the vehicle is on a hill, causing injury.

- When opening and closing doors, always use the door handle.

### Note

On the display of the SEAT Portable System (supplied by SEAT),  page 123 can be seen if at least one vehicle door has been left open or is not correctly closed.

## Childproof lock

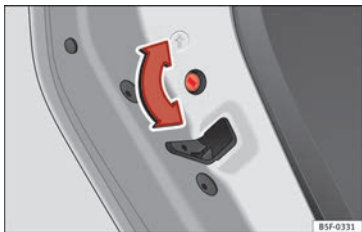

**Fig. 36** Childproof lock on the left hand side door

The childproof lock prevents the rear doors from being opened from the inside. This system prevents minors from opening a door accidentally while the vehicle is running.

This function is independent of the vehicle electronic opening and locking systems. It only affects rear doors. It can only be activated and deactivated manually, as described below:

### Activating the childproof lock

- Unlock the vehicle and open the door in which you wish to activate the childproof lock.
- With the door open, rotate the groove in the door using the ignition key, anti-clockwise for the right-hand side doors and clockwise for the left-hand side doors »» **Fig. 36**

and clockwise for the right-hand side doors.

### Deactivating the childproof lock

- Unlock the vehicle and open the door whose childproof lock you want to deactivate.
- With the door open, rotate the groove in the door using the ignition key, anti-clockwise for the right-hand side doors, and clockwise for the left-hand side doors »» **Fig. 36.**

Once the childproof lock is activated, the door can only be opened from the outside. The childproof lock can be activated or deactivated by inserting the key in the groove when the door is open, as described above.

## Rear lid

### Introduction

#### **WARNING**

Careless and unsuitable locking, opening and closing of the rear lid can cause accidents and serious injury.

- Open and close the rear lid only when nobody is in the way.

- Do not close the rear lid by pushing it down with your hand on the rear window. This could break and cause injury.

- Ensure the rear lid is locked after closing, otherwise, it may open unexpectedly while driving. A closed rear lid should be flush with the corresponding parts of the bodywork.

- Always keep the rear lid closed while driving to avoid toxic gases entering the vehicle interior.

- Do not open the rear lid when there is a load installed, for example a carrier system. Likewise, the boot hatch cannot be opened when a load is attached to it, for example bicycles. An open rear lid could close itself if there is an additional weight on it. If necessary, press down on the rear lid and remove the load.

- Close and lock both the rear lid and all the other doors when you are not using the vehicle. Ensure that nobody remains inside the vehicle.

- Never allow children to play inside or around the vehicle without supervision, especially if the rear lid is open. Children could enter the luggage compartment, close the rear lid and become trapped. Depending on the time of the year, temperatures inside a locked and closed vehicle can be extremely high or extremely low resulting in serious injuries and illness or even death, particularly for young children.

- Never leave children or disabled people alone in the vehicle. If the vehicle key or the

central locking button is used, they may be locked in the vehicle.

#### ⓘ CAUTION

Before opening the rear lid, ensure that there is sufficient free space to open and close it, for example if you are in a garage.

#### ⓘ Note

On the display of the Portable Navigation System (supplied by SEAT) »» page 123 can be seen if the rear lid has been left open or is not correctly shut.

## Opening the rear lid



**Fig. 37** On the vehicle key: button to unlock and open the boot hatch.

If bicycles are attached to a rack on the boot hatch, for example, in some cases, it may not

open automatically »» ⚠. Remove the load from the carrier and support the open rear lid.

### Opening with central locking

- Press the button  on the vehicle key »» **Fig. 37** for about one second to unlock the boot hatch.
- **OR:** Press the button  on the vehicle key until the rear lid opens automatically several centimetres.
- Opening the rear lid with the button.

### Opening with the vehicle mechanical key

- Insert the vehicle key into the lock cylinder of the driver door and turn the key **in an anti-clockwise direction** »» page 45.
- Opening the rear lid with the button.

#### ⚠ WARNING

Unsuitable or careless unlocking and opening of the rear lid could cause serious injuries.

- If there is a loaded luggage carrier on the rear lid, it could be unlocked or open but not recognised as such. An unlocked or open rear lid could open unexpectedly while driving.

#### ⓘ Note

At outside temperatures of less than 0 °C (+32 °F), the pressurised gas struts cannot always automatically lift the rear lid. In this case, open the rear lid manually.

## Closing the rear lid



**Fig. 38** Rear lid open: hand grip

### Closing the rear lid

- Grab the handgrip inside the rear lid »» **Fig. 38** (arrow).
- Push the rear lid downwards until it locks into place in the lock.
- Ensure that it is correctly closed by pulling on it firmly.

### Locking the rear lid with central locking\*

If you unlock the vehicle without opening any doors or the rear lid, it will lock again automatically after about 30 seconds. This function prevents the vehicle from remaining unlocked if the unlocking button is pressed by mistake.

Locking is only possible when the rear lid is correctly and fully closed. »»

- The rear lid is also locked by a central locking.
- If the vehicle rear lid is locked or unlocked using the  button, when it is closed once more it will lock automatically.
- A closed but not locked rear lid will lock automatically at a speed above about 9 km/h (6 mph).

## Locking the rear lid with the vehicle mechanical key

Locking is only possible when the rear lid is correctly and fully closed.

- Insert the vehicle key into the lock cylinder of the driver door and turn the key in a **clockwise direction** » page 45.

### WARNING

Unsuitable or careless closing and locking of the rear lid could cause serious injuries.

- Never allow children to play inside or around the vehicle without supervision, especially if the rear lid is open. Children could enter the luggage compartment, close the rear lid and become trapped. A locked vehicle can be subjected to extremely high and low temperatures, depending on the time of year, thus causing serious injuries/illness and even death.

### Note

Before closing the rear lid, make sure that the key has not been left inside the luggage compartment.



## Electric windows

### Opening and closing the electric windows



**Fig. 39** In the driver door: electric windows button

### Opening and closing the windows

Function	Necessary operations
Opening:	Press button  .
Closing:	Pull the switch  .

### WARNING

Careless use of the electric windows can cause serious injury.

- Only operate the electric windows when nobody is in the way.
- Never leave children or disabled people alone in the vehicle if the doors are to be locked. The windows cannot be opened in case of an emergency.
- Always take all the keys with you whenever you leave the vehicle. After turning off the ignition, the windows can be opened and closed for a short time using the buttons on the door as long as the driver door or passenger side door is not open.

### CAUTION

When the windows are open, rain can enter the vehicle, dampening the interior equipment and causing damage to the vehicle.

## Side-opening rear windows

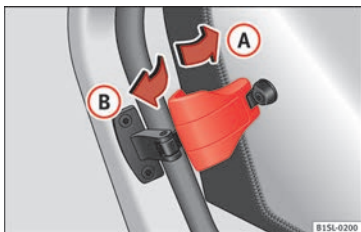

**Fig. 40** Lever to open and close the rear window

## Opening

Pull the release lever in the direction of arrow **A** and press outward until the lever engages.

## Closing

Pull the release lever in the direction of arrow **B** and then press the lever backward until it engages.

## Sliding/tilting electric panoramic sunroof

## Introduction

## ⚠ WARNING

If the sliding/tilting electric panoramic sunroof is used negligently or without paying due attention, it can cause serious injury.

- The sliding/tilting sunroof should only be opened or closed when no one is blocking its path.
- After switching off, it is still possible to open or close the sliding/tilting sunroof during a short space of time provided that neither the driver nor passenger door is opened.

## ⚠ CAUTION

- To prevent damage, when there are winter temperatures any ice or snow that there may be on the roof of the vehicle must be removed before opening or raising the sliding/tilting electric panoramic sunroof.
- Before leaving the vehicle or in the case of heavy rain, the sliding/tilting sunroof must always be closed. With the sliding/tilting sunroof open or raised, water can enter the passenger compartment and can cause considerable damage to the electrical system. As a result, other damage can occur in the vehicle.

- In the case of heavy rain, if the sliding/tilting sunroof is open, the interior equipment of the vehicle may get wet, destroying the seat heating and damaging the electrical system of the vehicle.

## i Note

- Leaves and other loose objects that land in the guides of the sliding/tilting sunroof should be removed periodically by hand or using a vacuum cleaner.
- If the sliding/tilting sunroof does not work correctly, the anti-trap function will not work either. In this case, you should take the vehicle to a specialised workshop.

## Opening and closing the sliding/tilting electric panoramic sunroof

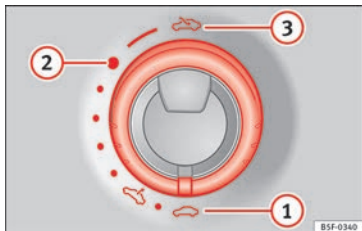

**Fig. 41** In the interior roof: turn the knob to open and close

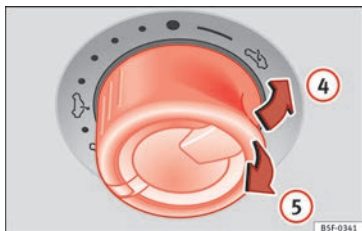

**Fig. 42** In the interior roof: turn the knob to raise and to close the sunroof

To raise the sliding/tilting sunroof, the knob must be in the basic position ①.

Function	»» Fig. 41 or »» Fig. 42	Action
Fully opening the sliding sunroof:	③	turn the knob beyond position 2 and hold it in that position until the sunroof reaches the required position.
Put the sliding sunroof in convenience position:	②	Turn the knob to the required position.
To set the intermediate position:	② to ①	
Fully closing the sliding sunroof:	①	
To raise the tilting sunroof completely:	④	briefly press the rear part of the knob.
To stop automatic operation:	④ or ⑤	Press or pull the knob again briefly.
To close completely:	⑤	briefly pull the rear part of the knob.

The sliding/tilting sunroof only works when switched on. After switching off, it is still possible to open or close the sliding/tilting sunroof during a short space of time provided

that neither the driver nor passenger door is opened.

All operations are interrupted when the rotary knob is actuated.

If it were not possible to close the sliding/tilting sunroof electrically, it would need to be closed manually. It is not possible to do an emergency close of the sliding/tilting sunroof without removing components of the vehicle. In such a case, obtain professional assistance.

### Sliding blind

With the roof grab handle situated in the rear part of the roof opening, it is possible to move the sliding blind to the required position.

#### **i** Note

**The convenience position permits sufficient ventilation with a level of sound produced by low wind.**

### Anti-trap function of the sliding/tilting electric panoramic sunroof

The anti-trap function can reduce the risk of injury when closing the sliding/tilting electric panoramic sunroof »» ⚠. If the sliding/tilting

sunroof encounters resistance or an obstacle when closing, it will immediately reopen.

- Check why the sliding/tilting sunroof has not closed.
- Try to close it again.
- If it is still not possible to close it due to an obstacle or resistance, it will remain in the corresponding position. Close it without the anti-trap function.

### Closing the sliding/tilting electric panoramic sunroof without the anti-trap function

- Within about 5 seconds of activating the anti-trap function, pull knob »» Fig. 42 ⑤ until the sliding/tilting sunroof is fully closed.
- **As such, the sliding/tilting sunroof will close without the anti-trap function!**
- If the sunroof still cannot be closed, visit a specialised workshop.

If the knob is released during the closing operation, the sliding/tilting electric panoramic sunroof opens automatically.

#### WARNING

Closing the sliding/tilting electric panoramic sunroof without the anti-trap function can result in serious injury.

- The sliding/tilting sunroof should always be closed carefully.

- **No person should ever remain in the way of the sliding/tilting sunroof, especially when closing without the anti-trap function.**

- **The anti-trap function does not prevent fingers or other parts of the body from becoming trapped against the roof frame and injuries occurring.**

## Lights and visibility

### Lights

#### Introduction

The legal requirements regarding the use of vehicle lights in each country must be observed.

The driver is personally responsible for the correct use and adjustment of the lights in all situations.

#### WARNING

If the headlights are set too high and the main beam is not used correctly, there is a risk of dazzling or distracting other road users. This could result in a serious accident.

- Always make sure that the headlights are correctly adjusted.
- Never use the main beam or flashed headlights as this could dazzle other drivers.

#### Control lamps

It lights up	Possible cause	Solution
	Rear fog light switched on.	»» page 56

It lights up	Possible cause	Solution
	Front fog lights switched on	» page 56
	Left or right turn signal. The control lamp flashes twice as fast when a vehicle turn signal is faulty.	If necessary, check the vehicle's lights.
	Main beam on or flasher on.	» page 57

Several warning and control lamps light up for a few seconds when the ignition is switched on, signalling that the function is being verified. They will switch off after a few seconds.

**⚠ WARNING**

Observe the safety warnings » **⚠** in Control and warning lamps on page 40.

## Turning on and off lights

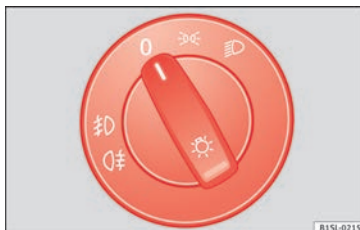

**Fig. 43** Next to the steering wheel: diagram of some of the types of light switch

The legal requirements regarding the use of vehicle lights in each country must be observed.

### Turn the light switch to the required position

» Fig. 43:

	When the ignition is switched off	When the ignition is on
0	Fog lights, dipped beam and side lights off.	Lights off, daytime driving light on.
	Side light on.	Side light on.
	Dipped beam off; if necessary, the side light comes on for a time.	Dipped beam switched on.

### Fog lights\*

The control lamp appears on the fog lights control connected.

- Switching on the front fog lights : Turn the switch to position or pull out to the first stop.
- Switching on the rear fog light : turn the light switch to position or pull out to the maximum.
- To switch off the fog lights, press the light switch or turn it to position 0.

### Audible warnings to advise the driver that the lights have not been switched off

If the key is not in the ignition and the driver door is open, an audible warning signal is heard in the following cases: this is a reminder to turn off the lights.

- When the light switch is in position .
- When the light switch is in position .

**⚠ WARNING**

The side lights or daytime driving lights are not bright enough to illuminate the road ahead and to ensure that other road users are able to see you.

- Always use your dipped beam head lights if it is raining or if visibility is poor.



## Lights and visibility: functions

### Parking light remains on both sides

If when switching off the ignition, the light control remains in the position  and the vehicle is closed from outside, both headlights, in addition to the side lights and the rear lights will light up.

### Daytime driving light

The daytime driving light consists of individual lights in the front headlamps.

When the daytime driving light is switched on, only the individual lights come on  .

The daytime lights are switched on each time the ignition is turned on if the light switch is in position 0.

### Switching the daytime driving light on and off

To switch the daytime driving light on or off, it is necessary to fit or remove the corresponding fuse. Ask for professional assistance for this.

#### WARNING

If the road is not well-lit and the vehicle is not clearly visible to other drivers, an accident may occur.

- Never use the daytime driving light if the road is not well-lit as a result of the weather

conditions and poor visibility. The daytime driving lights are not bright enough to illuminate the road ahead and to ensure that other road users are able to see you.

- The rear lights do not come on with the daytime driving light. A vehicle which does not have the rear lights on may not be visible to other drivers in the darkness, if it is raining or in conditions of poor visibility.

#### Note

The headlights, rear lights and turn signals may mist up temporarily on the inside in cool or damp weather. This is normal and in no way effects the useful life of the vehicle lighting system.

### Turn signal and main beam lever

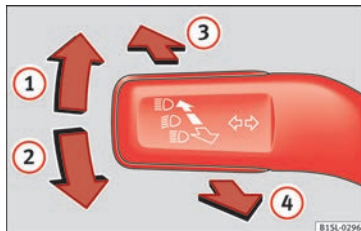





Fig. 44 Turn signal and main beam lever in their initial position

### Move the lever to the required position:

- ① Right turn signal.
- ② Left turn signal.
- ③ Switching on main beam  . When the main beam headlights are switched on, the warning lamp  is switched on in the instrument panel.
- ④ Switch on the flasher or switch off the main beam headlights. The *flashed beam* comes on if the lever is pressed. The warning lamp  will light up during this process.

Push the lever all the way down to turn off the corresponding function.

### Convenience turn signals

For the convenience turn signals, move the lever as far as possible upwards or downwards and release the lever. The turn signal will flash 3 times.

The convenience indicators can be deactivated at a Specialised workshop.

#### WARNING

Incorrect use of the headlights may cause accidents and serious injury, as the main beam may distract or dazzle other drivers. 

**Note**

- The turn signal only works when the ignition is switched on. The hazard warning lights also work when the ignition is switched off » page 170.
- If any of both turn signals fails, the warning lamp will start flashing twice faster than normal.
- The *main beam headlights* can only be switched on if the dipped beam headlights are already on.

### Adjusting the headlights

In those countries where vehicles drive on the other side of the road to the home country, the asymmetric dipped beam may dazzle drivers of oncoming vehicles.

For this reason, stickers may be needed to cover the headlights when driving abroad. For further information, please refer to a specialised workshop. SEAT recommends visiting a technical service.

**Note**

The use of stickers to cover headlights is only permitted over a short period. To modify the direction of the headlamps more permanently, please take the vehicle to a specialised workshop. SEAT recommends taking your car in for technical service.

### Headlight range control, lighting of instruments and controls

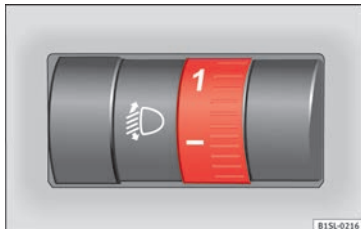

**Fig. 45** Next to the steering wheel: Headlight range control

### Headlamp height adjustment

The headlight range control » **Fig. 45** is modified according to the value of the headlight beam and the vehicle load status. This offers the driver optimum visibility and the headlights do not dazzle oncoming drivers » **⚠**.

The headlights can only be adjusted when the dipped beam is switched on.

To reset, turn switch » **Fig. 45:**

Value	Vehicle load status <sup>a)</sup>
-	Two front occupants, luggage compartment empty

To reset, turn switch » **Fig. 45:**

Value	Vehicle load status <sup>a)</sup>
1	All seats occupied, luggage compartment empty
2	All seats occupied, luggage compartment full
3	Driver only, luggage compartment full

<sup>a)</sup> If the vehicle load does not correspond to those shown in the table, it is possible to select intermediary positions.

### Instrument and switch lighting

When the side lights or dipped beam headlights are switched on, the lighting for instruments and controls lights up at a constant brightness.



**⚠ WARNING**

**Heavy objects in the vehicle may mean that the headlights dazzle and distract other drivers. This could result in a serious accident.**

- Adjust the light beam to the vehicle load status so that it does not blind other drivers.

### Reading light

But-ton/Switch	Function
0	Switching off the reading light.

But- ton/Switch	Function
	Switching on the reading light.
	Switches door contact control on (central position). The reading light comes on automatically when the vehicle is unlocked, a door is opened or the key is removed from the ignition. The light goes off a few seconds after all the doors are closed, the vehicle is locked or the ignition is switched on.

**Note**

The reading lights go out when the vehicle is locked, or a few minutes after the key is removed from the ignition. This prevents the vehicle's battery from discharging.

## Visibility

### Sun visors

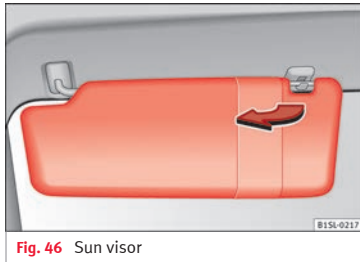

Fig. 46 Sun visor

#### Options for adjusting driver and front passenger sun visors:

- Lower the sun visor towards the windscreen.
- The sun visor can be pulled out of its mounting and turned towards the door.
- Swing the sun visor towards the door, longitudinally backwards.

#### Vanity mirror\*

There may be a vanity mirror in the folded sun visor on the passenger side and a card-holder in the driver sun visor.

**WARNING**

Folded sun blinds can reduce visibility.

- Always roll or fold sun blinds and visors away when not in use.

### Heat-insulating glass windscreen

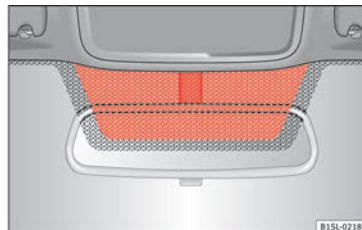

Fig. 47 Windscreen with reflective infrared and metal coating and small window (red surface)

The heat-insulating windscreens include a reflective infrared coating. The section above the rear vision mirror has been left uncoated (communication window) to allow electric components from the accessories shop to operate correctly »» Fig. 47.



**ⓘ CAUTION**

When the uncoated surface is covered or has a sticker on the interior or exterior, malfunctions in the electronic components may occur. Never cover the uncoated surface on the interior or exterior.

## Windscreen wiper and rear window wiper systems

### Introduction

**⚠ WARNING**

Water from the windscreen washer water bottle may freeze on the windscreen if it does not contain enough anti-freeze, reducing forward visibility.

- In winter, ensure the windscreen washer contains enough anti-freeze.
- In cold conditions, you should not use the wash/wipe system unless you have warmed the windscreen with the ventilation system. The antifreeze could freeze on the windscreen and reduce visibility.

**⚠ WARNING**

Worn or dirty wiper blades reduce visibility and increase the risk of accident and serious injury.

- Always replace damaged or worn blades or blades which do not clean the windscreen correctly.

**ⓘ CAUTION**

In icy conditions, always check that the wiper blades are not frozen to the glass before using the wipers for the first time. In cold weather, it may help to leave the vehicle parked with the wipers in service position » page 61.

### Window wiper lever

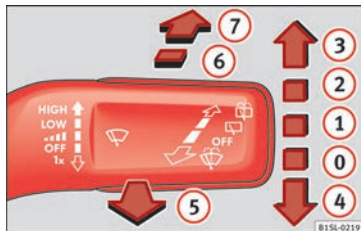

Fig. 48 Operating the windscreen wiper and rear wiper

**Move the lever to the required position » ⓘ:**

- |   |     |                           |
|---|-----|---------------------------|
| 0 | OFF | Windscreen wiper off.     |
| 1 | ⏏   | Windscreen interval wipe. |

**Move the lever to the required position » ⓘ:**

- |   |      |  |
|---|------|--|
| 2 | LOW  | Slow wipe.   |
| 3 | HIGH | Continuous wipe.   |
| 4 | 1x   | Brief wipe - short wipe. Hold the lever down for more time to increase the wipe frequency.     |
| 5 | ⏏    | Automatic wipe for cleaning windcreens with the lever up.                                      |
| 6 | ⏏    | Interval wipe for rear window. The wiper will wipe the window approximately every six seconds. |
| 7 | ⏏    | Automatic wipe for cleaning rear windows with the lever pressed.                               |

**ⓘ CAUTION**

If the ignition is switched off while the windscreen wipers are on, the windscreen wipers carry on wiping at the same level when the ignition is switched back on. Ice, snow and other obstacles may damage the windscreen wiper and the respective motor.

- If necessary, remove snow and ice from the windscreen wipers before starting your journey.
- Carefully lift the frozen windscreen wipers from the glass. SEAT recommends a de-icer spray for this operation.

**Note**

- The windscreen wipers will only work when the ignition is switched on.
- The interval wipe speed varies according to the vehicle speed. The faster the vehicle is moving, the more often the windscreen is cleaned.
- The rear wiper is automatically switched on when the windscreen wiper is on and the car is in reverse gear.

## Windscreen wiper functions

### Windscreen wiper performance in different situations

If the vehicle is at a standstill	The activated position provisionally changes to the previous position.
For intermittent wipers	Intervals between wipes depend on the vehicle's speed. The higher the vehicle speed the shorter the intervals.

**Note**

**The wiper will try to wipe away any obstacles that are on the windscreen. The wiper will stop moving if the obstacle blocks its path. Remove the obstacle and switch the wiper back on again.**

## Windscreen wipers service position

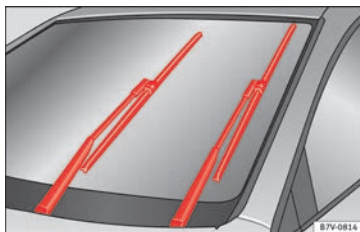

Fig. 49 Wipers in service position

The wiper arms can be raised when the wipers are in service position » Fig. 49. To place the windscreen wipers in the service position, proceed as follows:

- The bonnet must be closed » page 143.
- Switch the ignition on and off.
- Press the windscreen wiper lever downwards briefly » Fig. 48 ④.

Before driving, always lower the wiper arms. When the ignition is switched on, the windscreen wiper arms return to their initial position upon activating the windscreen wiper lever.

### Lifting and returning windscreen wiper arms

- Place the wiper arms in the service position » ①.

- Only hold the wiper arms at the point where the blade is fixed.

**CAUTION**

- To prevent damage to the bonnet and the wiper arms, only leave them in the service position.
- Before driving, always lower the wiper arms.

## Rear vision mirror

### Rear vision mirror

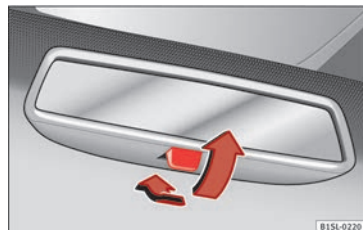

Fig. 50 Manual anti-dazzle function for rear vision mirror

The driver should always adjust the rear vision mirror to permit adequate visibility through the rear window. »

### Manual anti-dazzle function for interior rear vision mirror

- Basic position: point the lever at the bottom of the mirror forwards.
- Pull the lever to the back to select the anti-dazzle function »» Fig. 50.

### Exterior mirrors

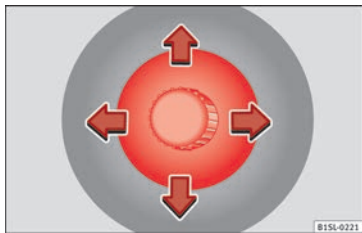

Fig. 51 In the front doors: button to adjust the mechanical exterior rear vision mirror

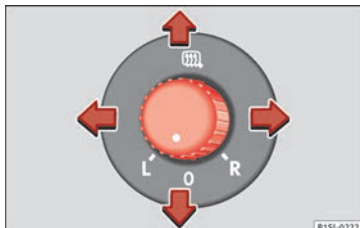

Fig. 52 In the driver door: rotary control for the exterior electric mirrors

Adjust the exterior mirrors by pressing the adjust button »» Fig. 51 or the rotary control\* »» Fig. 52.

#### Turn the rotary control »» Fig. 52 to the required position:



Switch on the exterior mirror heating

**L**

Adjust the left-hand exterior mirror by turning the knob forward, backward, to the right or to the left.

**0**

Zero position. Exterior mirror heating switched off, it is not possible to adjust the exterior mirrors.

**R**

Adjust the right-hand exterior mirror by turning the knob forward, backward, to the right or to the left.

Folding in the exterior mirrors and returning them to their original position is possible through a mechanical system. Carefully fold

the exterior rear vision mirror casing towards the side window or pull it away from the window until it clicks into place.

#### ⚠ WARNING

Fold and unfold the exterior mirror, taking care to avoid injuries.

- Only fold or unfold the exterior mirror when there is no-one in the way of the mirror.
- When moving the mirror, take care not to trap fingers between the mirror and the mirror bracket.

#### ⚠ WARNING

Failure to correctly estimate the distance of the vehicle behind could lead to serious accident.

- Rear-view convex or aspheric mirrors increase the field of vision, however objects appear smaller and further away in the mirrors.
- The use of these mirrors to estimate the distance to the next vehicle when changing lane is imprecise and could result in serious accident.
- If possible, use the rear vision mirror to estimate distances to vehicles behind you or in other circumstances.
- Make sure that the rear visibility is adequate.

 For the sake of the environment

The exterior mirror heating should be switched off when it is no longer needed. Otherwise, it is an unnecessary fuel waste.

 Note

In the event of faults, the electric exterior mirrors can be adjusted manually by pressing the edge of the mirror surface.

## Seats and head restraints

### Adjusting the seat and head restraints

#### Manual seat adjustment

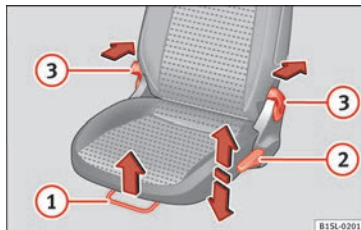

Fig. 53 Front left seat controls

The controls are mirrored for the front right-hand seat.

The front seat head restraints are integrated in the backrests and adjusting them is not possible.

Fig. 53	Function	Necessary operations
①	Moving the head restraint backwards or forwards.	Pull the lever and move the seat forwards. The front seat must be engaged when the lever is released!

Fig. 53	Function	Necessary operations
②	Adjusting the seat height.	Pull the lever up or push down (several times if necessary) from its home position.
③	3 doors: Easy Entry + adjustable seat angle function.  5 doors: only adjustable seat angle function.	<i>Adjust:</i> pull the lever and adjust the backrest seat angle until you reach the desired position. The seat backrest must be engaged.
		<i>To fold:</i> Pull the lever and tilt the backrest. At the same time, move the seat forward.
		<i>To tilt open:</i> Move the seat back until the catch engages. Pull the lever and tilt open the backrest. The backrest must engage in the upright position.

## Removing and installing the rear head restraints

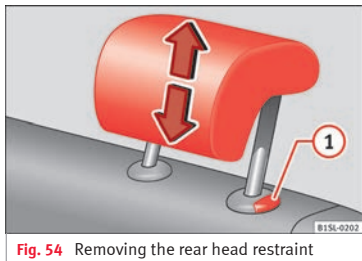

Fig. 54 Removing the rear head restraint

The rear seats are equipped with a head restraint.

### Removing the rear head restraint.

- Unlock the seat backrest and fold it forward »» page 73.
- Push the head restraint up as far as it will go »» ⚠.
- Pull the head restraint out of the fitting without releasing the button »» Fig. 54 ①.
- Fold the backrest of the rear seat backward again until it is engaged.
- Safely store the removed head restraints.

### Removing the rear head restraint.

- Unlock the seat backrest and fold it forward »» page 73.

- Insert the head restraint into the guides on the seat backrest.
- Push the head restraint down as far as it will go while pressing button ①.
- Fold the backrest of the rear seat backward again until it is engaged.
- Adjust the head restraint to the correct position »» page 9.

### ⚠ WARNING

**Travelling with the head restraints removed or improperly adjusted increases the risk of severe or fatal injuries in the event of accidents and sudden braking or manoeuvres.**

- Always fit and adjust the head restraint properly whenever a person is occupying a seat.
- Refit any removed head restraints immediately so that passengers are properly protected.

### ⓘ CAUTION

**When removing and fitting the head restraint, make sure it does not hit the headliner of the vehicle or the front seat backrest. Otherwise, the interior roof and other parts of the vehicle could be damaged.**

## Seat functions

### Seat heating\*

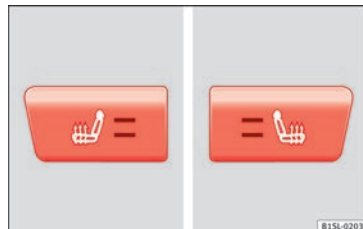

Fig. 55 In the centre console: Front seats heating switch

The front seat cushions can be heated electrically when the ignition is switched on.

Switch off seat heating if there is nobody in the seat.

Function	Action »» Fig. 55
Activate	Press button . Seat heating is switched on fully. All warning signals light up.
Adjusting the heating output	Press the button  again to adjust the desired heat.
Deactivating	Keep pressing button  until all of the lights are switched off.

**⚠ WARNING**

People whose pain and temperature threshold has been affected by some kind of medicine, paraplegia or chronic illness (e.g. diabetes) may sustain burns to the back, buttocks and legs from using the seat heaters that may lead to a long healing process or that may never completely heal. Seek medical advice if you have doubts regarding your health.

- People with limited pain and temperature thresholds must never use seat heating.

**⚠ WARNING**

Inappropriate use of the seat functions can cause severe injuries.

- Assume the proper sitting position before your trip and remain in it throughout. This also applies to the other occupants.
- Keep hands, fingers, feet and other limbs away from the seat operating and adjustment radius.

**ⓘ CAUTION**

- To avoid damaging the heating elements of the seat heaters, please do not kneel on the seat or apply sharp pressure to a single point on the seat cushion or backrest.
- Liquids, sharp objects and insulating materials on the seat could damage the seat heating.

- In the event of smells, switch off the seat heating immediately and have the unit inspected by a specialised workshop.

**♻ For the sake of the environment**

The seat heating should remain on only when needed. Otherwise, it is an unnecessary fuel waste.

## Transport and practical equipment

### Transporting objects

#### Introduction

Always transport heavy loads in the luggage compartment and place the seat backs in a vertical position. Never overload the vehicle. Both the carrying capacity as well as the distribution of the load in the vehicle affect driving behaviour and braking ability» ⚠.

**⚠ WARNING**

Unsecured or incorrectly secured objects can cause serious injury in case of a sudden manoeuvring or breaking or in case of an accident. This is especially true when objects are struck by a detonating airbag and fired through the vehicle interior. To reduce the risks, please note the following:

- Secure all objects in the vehicle. Always keep equipment and heavy objects in the luggage compartment.
- Always secure objects with suitable rope or slings so that they cannot enter the deployment areas around the frontal or side airbags in case of sudden braking or an accident.
- Always ensure that objects inside the vehicle cannot move into the deployment area of the bags while driving.

- While driving, always keep object compartments closed.
- Remove all objects from the front passenger seat when it is folded down. When the seat backrest is folded down, it presses on small and light objects and these are detected by the weight sensor on the seat; this sends false information to the airbag control unit.
- While the backrest of the front passenger seat is folded, the frontal airbag must remain disconnected and the **PASSENGER AIRBAG OFF**  light on.
- Objects secured in the vehicle should never be placed in such a way as to make passengers sit in an incorrect position.
- If secured objects occupy a seat, this seat should not be occupied or used by anyone.

### WARNING

The driving behaviour and braking ability change when transporting heavy and large objects.

- Adjust your speed and driving style to visibility, road, traffic and weather conditions.
- Accelerate gently and carefully.
- Avoid sudden braking and manoeuvres.
- Brake early.

### Transporting a load

#### Secure all objects in the vehicle

- Distribute the load throughout the vehicle and on the roof as uniformly as possible.
- Transport heavy objects as far forward as possible in the luggage compartment and lock the seat backs in the vertical position.
- Check the headlight adjustment  
»» page 55.
- Use the suitable tyre pressure according to the load being transported. Read the tyre inflation information label »» page 158.

### CAUTION

Objects on the shelf could chafe against the wires of the heating element in the heated rear window and cause damage.

### Note

Please refer to the notes on loading the roof carrier »» page 77.

### Driving with the rear lid open

Driving with the rear lid open creates an additional risk. Secure all objects and secure the rear lid correctly and take all measures possible to reduce toxic gases from entering the vehicle.

### WARNING

Driving with the rear lid unlocked or open could cause serious injuries.

- Always drive with the rear lid closed.
- Secure all objects in the vehicle. Loose items could fall out of the vehicle and injure other road users or damage other vehicles.
- Drive particularly carefully and think ahead.
- Avoid sudden manoeuvres and braking given that this could cause an uncontrolled movement of the open rear lid.
- When transporting objects that protrude out of the luggage compartment, indicate them suitably. Observe legal requirements.
- If objects must project out of the luggage compartment, the rear lid must never be used to “secure” or “attach” objects.
- If a baggage rack is fitted on the rear lid, it should be removed before travelling with the rear lid open.

### WARNING

Toxic gases may enter the vehicle interior when the rear lid is open. This could cause loss of consciousness, carbon monoxide poisoning, serious injury and accidents.

- To avoid toxic gases entering the vehicle always drive with the rear lid closed.

- In exceptional circumstances, if you must drive with the rear lid open, observe the following to reduce the entry of toxic gases inside the vehicle:

- Close all windows.
- Disable air recirculation mode.
- Open all of the air outlets on the instrument panel.
- Switch on the blower to maximum.

### ⓘ CAUTION

An open boot hatch changes the length and height of the vehicle.

### Driving a loaded vehicle

For the best handling when driving a loaded vehicle, note the following:

- Secure all objects » page 66.
- Accelerate gently and carefully.
- Avoid sudden braking and manoeuvres.
- Brake early.
- If necessary, read the instructions for driving with a roof carrier system » page 77.

### ⚠ WARNING

A sliding load could considerably affect the stability and safety of the vehicle resulting in an accident with serious consequences.

- Secure loads correctly so they do not move.
- When transporting heavy objects, use suitable ropes or straps.
- Lock the seat backs in vertical position.

## Practical equipment

### Introduction

Storage compartments must only be used to store light or small objects.

### ⚠ WARNING

In the event of sudden braking movements or turns, loose objects may be thrown around the vehicle interior. This could cause serious injuries to passengers and cause the driver to lose control of the vehicle.

- Do not transport animals or place hard, heavy or sharp objects inside the vehicle in: open storage compartments, dash panel, rear shelf, items of clothing or bags.
- While driving, always keep object compartments closed.

### ⚠ WARNING

Objects falling into the driver's footwell could prevent use of the pedals. This could lead the driver to lose control of the vehicle, increasing the risk of a serious accident.

- Make sure the pedals can be used at all times, with no objects rolling underneath them.
- The floor mat should always be secured to the floor.
- Never place other mats or rugs on top of the original mat supplied by the factory.
- Make sure that no objects can fall into the driver's footwell while the vehicle is in motion.

### ⓘ CAUTION

- Objects on the shelf could chafe against the wires of the heating element in the heated rear window and cause damage.
- Do not keep temperature-sensitive objects, food or medicines inside the vehicle. Heat and cold could damage them or render them useless.
- Light-transparent objects placed inside the vehicle, such as lenses, magnifying glasses or transparent suction caps on the windows, may concentrate the sun's rays and cause damage to the vehicle.

### ℹ Note

The ventilating slits between the heated rear window and the rear shelf must not be covered so that used air can escape from the vehicle.

### Storage compartment on the driver side

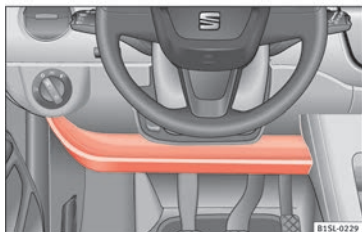

**Fig. 56** On the driver side: storage compartment

There may be a storage compartment on the driver side.

### Compartment on the centre console



**Fig. 57** In the front part of the centre console: storage compartment

The storage compartment » **Fig. 57** may be used as a drink holder » page 71 or as an ashtray\* » page 71 or to store small objects.

**i** Note

A 12 volt electrical socket » page 72 can be found in the storage compartment.

### Storage compartment with cover on the passenger side\*

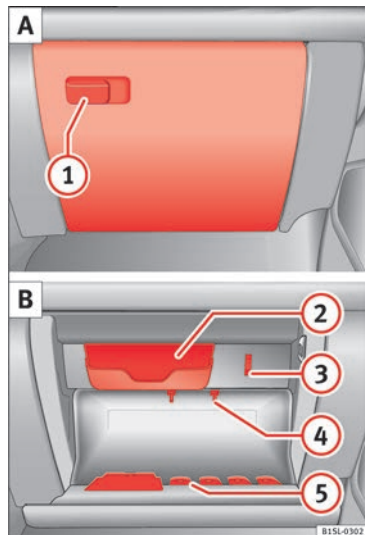

**Fig. 58** Storage compartment with cover on the passenger side

There may be a storage compartment with cover on the passenger side.

### Opening and closing the storage compartment cover

Pull the lever to *open* » Fig. 58 ①.

To *close*, press the cover upwards until it clicks into place.

### Sunglasses storage compartment.

Sunglasses can be stored in the passenger side storage compartment.

The sunglasses storage compartment is in the upper area of the storage compartment ②.

### Supports

Next to the eyeglass storage compartment is a notebook holder ③ and in the interior of the storage compartment there is a pen holder ④, a map storage area and a coin tray ⑤.

#### ⓘ CAUTION

For structural reasons, some model versions will have gaps behind the glove compartment into which small objects may fall. This could lead to strange noises and damage to the vehicle. Therefore, do not store small objects in the glove compartment, apart from those stored in the spaces provided.

### Bag support\*

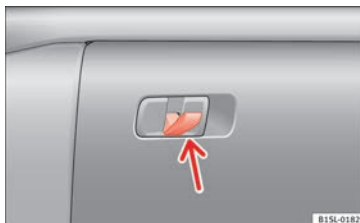

Fig. 59 Storage on front passenger side: folding hook.

On the opening lever of the glove compartment on the passenger side there is a folding hook » Fig. 59 for hanging small items of luggage, e.g. bags, etc.

#### ⓘ CAUTION

- The maximum weight for the hook is 1.5 kg.
- With the hook folded forward, it automatically draws up when the compartment is opened.
- We recommend removing hanging bags from the hook before opening the glove compartment.

### Open storage compartment on the passenger side\*

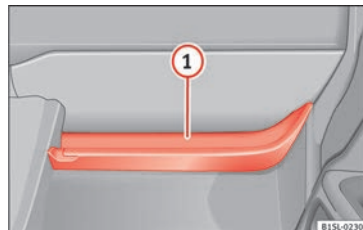

Fig. 60 Open storage compartment on the passenger side

There may be an open storage compartment on the passenger side.

### Support

In the open glove compartment there is a hook for bags » Fig. 60 ①.

### Storage compartment in the back of the centre console

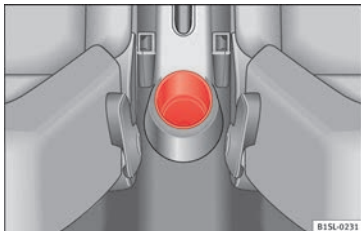

**Fig. 61** In the back part of the centre console: storage compartment

The drink holder at the back of the centre console can be used as a storage compartment.

### Other storage compartments

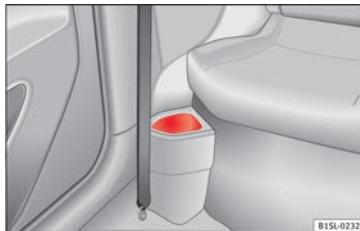

**Fig. 62** In front of the rear seats: storage compartment

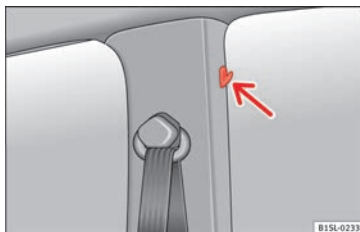

**Fig. 63** In the centre pillars: coat hooks

#### Coat hooks

The centre pillars contain garment hooks **» Fig. 63** (arrow).

#### Other storage compartments:

- In the front door trims **» page 34**.

- In front of the rear seats **» Fig. 62**.
- Rear shelf for light items of clothing\*.
- Bag hook in the luggage compartment **» page 73**.
- In the upper part of the centre console, instead of the radio **» Fig. 23 11**.

#### **⚠ WARNING**

**Clothing hung on the coat hooks could restrict the driver's view and lead to serious accidents.**

- Hang the clothes from the hooks so that driver's view is not restricted.
- The coat hook is suitable for light items of clothing. Never place heavy, hard or sharp objects in the bags.

#### Drink holders

The drink holders are in the open storage compartments in the driver and passenger doors.

#### **⚠ WARNING**

**Improper use of the drink holders can cause injury.**

- Do not place containers with hot drinks in a drink holder. During sudden braking or driving manoeuvres, the hot drink could be spilled and lead to scalding.

- Ensure that no bottles or other object are dropped in the driver footwell, as they could get under the pedals and obstruct their working.
- Never place heavy containers, food or other heavy objects in the drink holder. In the event of an accident, these heavy objects could be “thrown around” the vehicle interior and cause serious injuries.

**⚠ WARNING**

Closed bottles inside the vehicle could explode or crack due to the heat or the cold.

- Never leave a closed bottle in the vehicle if the inside temperature is too high or too low.

**⚠ CAUTION**

Do not leave open drinks containers in the drink holders when the vehicle is in motion. They could spill during braking, for example, and cause damage to the vehicle and the electrical system.

**Centre console drink holders**



**Fig. 64** In the front part of the centre console: drink holder

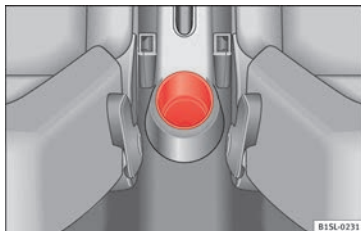

**Fig. 65** In the back part of the centre console: drink holder

There are drink holders in the front and rear parts of the centre console.

**Securing the drink container in the front drink holder**

Fold the drink holder »» **Fig. 64** forward.

Place the drink container in the drink holder so that it is securely surrounded.

**Ashtray\***



**Fig. 66** In the front part of the centre console: opening the ashtray.

**Opening and closing the ashtray**

To *open*, lift the lid of the ashtray in the direction of the arrow »» **Fig. 66**.

To *close*, push the ashtray lid down.

**Emptying the ashtray**

- Remove the ashtray from the storage compartment lifting it up. »»

- After emptying the ashtray, insert it into the drink holder from above.

### **WARNING**

Incorrect use of the ashtray may cause a fire or burns and other serious injuries.

- Never put paper or other flammable objects in the ashtray.

### Cigarette lighter\*



**Fig. 67** In the front part of the centre console: lighter

- Push the button on the cigarette lighter inward with the ignition on »» **Fig. 67**.
- Wait for the lighter to pop out slightly.
- Pull out the cigarette lighter and light the cigarette on the glowing coil »» **▲**.
- Replace the cigarette lighter in its insert.

### **WARNING**

Undue use of the cigarette lighter may cause a fire or burns and other serious injuries.

- The cigarette lighter must only be used to light cigarettes or similar.
- Never leave children unsupervised in the vehicle. The cigarette lighter can be used when the ignition is switched on.

### **Note**

The cigarette lighter can also be used with the 12 Volt socket.

### Power socket\*



**Fig. 68** Front centre console: 12 Volt socket in the storage compartment

Electrical equipment can be connected to the socket in the vehicle.

All connected appliances should be in perfect working order without any faults.

### Maximum power consumption

Power socket	Maximum power consumption
12 Volts	120 Watts

The maximum capacity of the socket must not be exceeded. The power consumption is indicated on the rating plate of each appliance.

Where 2 or more appliances are connected at the same time, the total rating of all the connected devices must never exceed 190 Watts »» **!**

### 12 volt power socket

The 12 volt socket is found in the storage compartment at the front of the centre console »» **Fig. 68** and only functions when the ignition is switched on.

Using electrical appliances with the engine stopped and the ignition switched on will drain the battery. Therefore, electrical devices connected to the power socket can only be used when the engine is running.

To prevent voltage variations from causing damage, switch off the electrical device connected to the 12 Volt power socket before

switching the ignition on or off and before starting the engine.

#### WARNING

Improper use of the socket or electrical devices could lead to a fire and cause serious injuries.

- Never leave children unsupervised in the vehicle. The socket and equipment connected to it can be used when the ignition is switched on.
- Should a connected electrical device overheat, switch it off and unplug it immediately.

#### CAUTION

- Always follow the operating instructions for the appliances to be connected!
- Never exceed the maximum power rating as this could damage the vehicle's general electrical system.
- 12 volt power socket:
  - Only use accessories with approved electromagnetic compatibility according to current regulations.
  - Never power the socket.

#### CAUTION

- To avoid damage to the vehicle's electrical system, never connect equipment that generates electrical current, such as solar panels or battery chargers, to the 12 Volt power

sockets in order to charge the vehicle's battery.

- Only use accessories with approved electromagnetic compatibility according to current regulations.
- To avoid damage due to voltage variations, switch off all devices connected to the 12 V socket before switching the ignition on or off and before starting the engine.
- Never connect an appliance to the 12 Volt power socket that consumes more than the power indicated in watts. Exceeding the maximum power absorption could damage the vehicle's electrical system.

#### For the sake of the environment

Do not leave the engine running when the vehicle is at a standstill.

#### Note

- Using devices with the engine stopped and the ignition switched on will drain the battery.
- Unshielded equipment can cause interference on the radio equipment and the vehicle's electrical system.
- If electrical equipment is used near an aerial, you may observe interference in the reception of AM stations.

## Loading luggage compartment

### Introduction

Always transport heavy loads in the luggage compartment and place the seat backs in a vertical position. Never overload the vehicle. Both the carrying capacity as well as the distribution of the load in the vehicle have effects on the driving behaviour and braking ability » .

#### WARNING

When the vehicle is not in use or being watched, always lock the doors and the rear lid to reduce the risk of serious injury or death.

- Do not leave children unwatched, especially when the boot is open. Children could climb into the luggage compartment, close the rear lid from inside and be unable to escape themselves. This could lead to serious injury or death.
- Never allow children to play in or around the vehicle.
- Never transport people in the luggage compartment.

#### WARNING

Unsecured or incorrectly secured objects can cause serious injury in case of a sudden manoeuvring or braking or in case of an accident. This is especially true when objects are »

struck by a detonating airbag and fired through the vehicle interior. To reduce the risks, please note the following:

- Secure all objects in the vehicle. Always place equipment and heavy objects in the boot.
- Always secure objects to the fastening rings with suitable rope or straps to prevent them from being thrown around the interior and moving to the airbag deployment area in the event of sudden movements or accidents.
- While driving, always keep object compartments closed.
- Do not place hard, heavy or sharp objects inside the vehicle interior, in open storage compartments, the rear shelf or on the dash panel.
- Remove hard, heavy and sharp objects from clothes and pockets inside the vehicle and store securely.

#### **WARNING**

The transport of heavy object changes vehicle handling and increases braking distance. Heavy loads that have not been stored or secured correctly could cause loss of control and result in serious injury.

- Vehicle handling changes when transporting heavy objects due to a change in the centre of gravity.
- Distribute the load as uniformly and as low down on the vehicle as possible.

- Store heavy objects in the luggage compartment as far from the rear axle as possible.

#### **CAUTION**

Hard objects on the rear shelf could chafe against the wires of the heating element in the heated rear window and cause damage.

#### **Note**

The ventilating slits between the heated rear window and the rear shelf must not be covered so that used air can escape from the vehicle.

#### **Folding and lifting up the rear seat bench backrest**

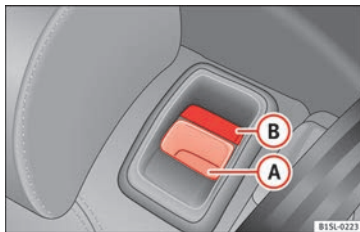

**Fig. 69** Rear seat: unlock button (A); red marking (B)

The rear seat backrest can be folded forward to extend the luggage compartment.

#### **Folding the rear seat backrest forwards**

- Push the head restraint down as far as it will go or remove it if necessary »» page 6 and store it in a safe place.
- Pull the unlock switch »» Fig. 69 (A) forwards whilst simultaneously lifting the rear seat backrest.
- The rear seat backrest is not engaged when the red marking of the button (B) is visible.
- If the rear seat backrest is folded, people (including children) are not permitted to travel in the rear folded seats.

#### **Folding up the rear seat backrest**

- Lift back the backrest of the rear seat and push it firmly into the lock until it clicks securely into place »» ⚠.
- The red marking on the unlock button (B) must not be seen.
- Make sure that the backrest of the rear seat is securely locked in position so that the seat belts can provide proper protection in the rear seats.
- If necessary, reinstall and readjust the head restraints »» page 64.

**⚠ WARNING**

Folding and lifting the backrests of the rear seats carelessly without paying attention could cause serious injury.

- Never fold or lift the seats while driving.
- Do not trap or damage seat belts when raising the seat backrest.
- Keep hands, fingers, feet and other limbs away from the range of the rear seat backrests when folding and lifting them.
- All seat backrests must engage correctly for the seat belts on the rear seats to work properly. When the backrest of an occupied seat is not correctly locked in place, the passenger can be thrust forward with the rear seat backrest in case of sudden braking, sudden manoeuvres or an accident.

• A red signal on the button **(B)** warns that the backrest is not engaged. Always check to make sure that the red mark is not visible when the backrest of the rear seat is in the upright position.

- No seat must be occupied if the backrest of the rear seat is folded or not correctly engaged.

**ⓘ CAUTION**

Before folding the rear seat backrest, adjust the front seats so that neither the head restraint or backrest hit them when folded. If necessary, remove the head restraints  
 »» page 64 and store them safely.

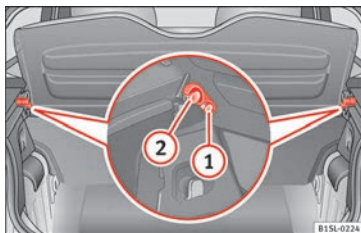
**Rear shelf\***

**Fig. 70** In the luggage compartment: removing and installing the rear shelf

You may put light items of clothing on the rear shelf. Check that the rear view is not limited.

**Lifting up the rear shelf**

Lift up the rear shelf and secure it into the side locks »» **Fig. 70** **(1)**. Check that it is properly engaged. To lower the rear shelf, press it until it is released from the locks.

**Removing the shelf**

Pull the rear shelf upward, removing it from the side supports **(2)**.

**Lifting up the rear shelf**

Press the rear shelf down into the side supports **(2)**.

**⚠ WARNING**

Unsecured or incorrectly secured objects or animals on the rear shelf could cause serious injuries in case of a sudden manoeuvre, sudden braking or an accident.

- Do not leave hard, heavy or sharp objects (loose or in bags) on the rear shelf.
- Never transport animals on the rear shelf.
- Never drive with the rear shelf raised. Always lower it or remove it before the journey.

**ⓘ CAUTION**

To prevent the rear shelf from being damaged:

- Always check that the side supports are firmly engaged.
- Regulate the height of the load in the luggage compartment to ensure the rear shelf does not press down on the load with the rear lid closed.

## Boot variable floor

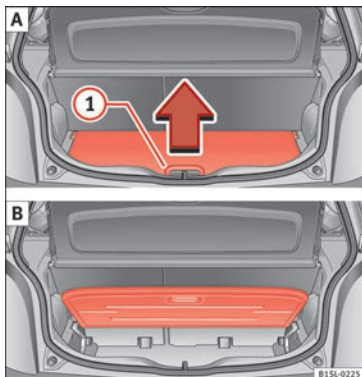

**Fig. 71** A: open the boot variable floor. B: raised boot variable floor.

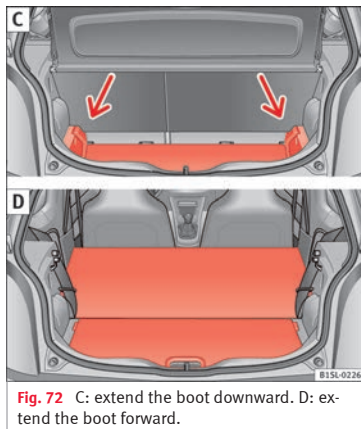

**Fig. 72** C: extend the boot downward. D: extend the boot forward.

### Raise and lower the boot floor

- To *raise* the floor, raise handle » **Fig. 71 ①** in the direction of the arrow and pull from the floor all the way up » **Fig. 71 B**.
- To *lower* it, guide the floor downward.

### Extend the boot downward

- Raise the boot floor and push it downward in the rail » **Fig. 72 C** (arrows)
- Place the variable floor over the floor lining.
- If necessary, fold the backrest of the rear seat forward » **page 74**.

### Extending the luggage compartment forward

- Disassemble the luggage compartment tray » **page 75**.
- Disassemble the rear headrests » **page 6**.
- Fold the backrest of the rear seat forward » **page 74**.
- If necessary, expand the boot downward.

#### ⓘ CAUTION

Do not let the boot floor fall when closing it. Always carefully guide it downward in a controlled manner. Otherwise, the lining and the floor of the boot could be damaged.

## Class N1 (commercial) vehicles

For safe vehicle operation, the electrical system must work perfectly. Special attention should be paid so it is not damaged during adjustment, loading and unloading of transported objects.

### Fastening rings\*

In the front part of the luggage compartment, there may be fastening rings to secure the luggage.

In order to use the fastening rings, they must be lifted beforehand.

**⚠ WARNING**

If unsuitable or damaged belts or retaining straps are used, they may break in the event of braking or an accident. Objects could then be launched across the passenger compartment and cause serious or fatal injuries.

- It is important to always use belts or retaining straps that are suitable and in a good condition.
- Belts and retaining straps should be securely fastened to the fastening rings.
- Objects in the luggage compartment that are unsecured could move suddenly and modify the handling of the vehicle.
- Small light objects should also be fixed in place.
- The maximum tensile load of the fastening ring for securing objects should never be exceeded.
- A child seat should never be secured with the fastening rings.

**i Note**

- The maximum tensile load that the fastening rings can support is 3.5 kN.
- Belts and securing systems for the appropriate load can be obtained from specialised dealerships. SEAT recommends visiting a SEAT dealership for this.

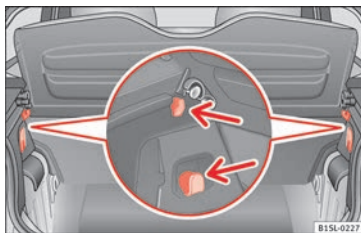
**Retaining hooks**

**Fig. 73** In the luggage compartment: retaining hooks

There may be hooks in the upper left and right part of the luggage compartment.

**⚠ WARNING**

**Never use these hooks to secure objects. In case of sudden braking or an accident, they could rupture.**

**⚠ CAUTION**

**The hooks can support a maximum of 2.5 kg each.**

**Roof carrier system****Introduction**

The vehicle roof has been designed to optimise aerodynamics. For this reason, conventional roof carrier systems cannot be secured to the water drains.

Given that the water drains have been incorporated into the roof for aerodynamic reasons, only the SEAT approved basic supports and roof carrier systems can be used.

**When the roof carrier system should be removed:**

- When they are not used.
- When the vehicle is being washed in a car wash.
- When the vehicle height exceeds the maximum height, for example, in some garages.

**⚠ WARNING**

**The risk of an accident is increased by transporting heavy or bulky loads on the roof, which affects the car's handling by shifting the centre of gravity and increasing susceptibility to cross winds.**

- Always secure loads correctly with suitable and undamaged attachment rope or straps.
- Large, heavy, wide and flat loads negatively affect the vehicle aerodynamics, centre of gravity and handling.

- Avoid brusque manoeuvres and sudden braking.
- Adjust your speed and driving style to visibility, road, traffic and weather conditions.

**CAUTION**

- Always remove the roof carrier system from the roof before entering a car wash.
- The height of your vehicle is changed by the installation of the roof carrier and the load secured on it. Compare the vehicle height with the passage height, for example in underground car parks or for garage doors.
- The roof antenna and the range of the rear lid should not be affected by the roof carrier system or the load being transported.
- Take extra care not to let the hatch strike the roof load when opening.

**For the sake of the environment**

The vehicle uses more fuel when the roof carrier system is fitted.

**Securing the base supports and roof carrier system**

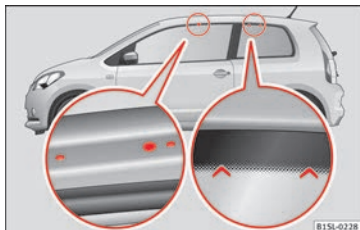

**Fig. 74** Attachment points for the basic supports and the roof carrier system in two-door vehicles.

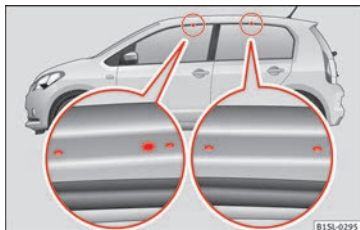

**Fig. 75** Attachment points for the basic supports and the roof carrier system in four-door vehicles.

The mounts are the basis of a complete roof carrier system. Special fixtures must be added in order to safely transport luggage, bicy-

cles, skis, surf boards or boats on the roof. The suitable accessories can be acquired at SEAT dealerships.

**Securing the base supports and roof carrier system**

The roof carrier system must always be installed exactly according to the instructions provided.

**Two-door vehicles:** the holes and marks indicating the fitting points for base front supports are in the lower half of the roof struts » **Fig. 74** (enlarged left image). The holes and marks are only seen with the door open. The fitting marks for base rear supports are in the upper half of the windows » **Fig. 74** (enlarged right image).

**Four-door vehicles:** the holes or marks indicating the fitting points for base supports are in the lower half of the roof struts and can only be seen with the door open » **Fig. 75**.

The base support should **only** be fitted to the points indicated in the diagram.

**WARNING**

**If the base supports and the roof carrier system are incorrectly fitted or used in an unsuitable manner, the entire system could break free causing accident and injury.**

- Always take the manufacturer assembly instructions into account.

- Only use base supports and roof carrier systems that are not damaged and are correctly fitted.
- The base support should only be fitted to the points indicated in the diagram » Fig. 74.
- Secure the base supports and roof carrier system correctly.
- Check the screws and attachments before driving and after a short distance. During each long journey, check the attachments during every break.
- Always fit the roof carrier system correctly for wheels, skis and surfboards, etc.
- Never modify or repair the basic supports or roof carrier system.

### Note

Read and take into account the instructions included with the roof carrier system fitted and keep them in the vehicle.

### Loading the roof carrier system

Loads can only be correctly secured when the roof carrier system is correctly fitted » .

#### Maximum authorised roof load

The maximum authorised roof load is **50 kg**. The roof load includes the weight of the base support, the roof carrier system and the load being transported » .

Always check the weight of the base support, the roof carrier system and the weight of the load to be transported and, if necessary, weigh them. Never exceed the maximum authorised roof load.

If you are using a roof carrier with a lower weight rating, you cannot transport the maximum roof load. Do not exceed the maximum weight limit for the roof carrier given in the fitting instructions.

#### Distributing a load

Uniformly distribute loads and secure them correctly » .

#### Check attachments

After fitting the base supports and the roof carrier system, always check the attachments after a short trip and at regular intervals.

### WARNING

Exceeding the maximum authorised roof load can result in accidents and/or vehicle damage.

- Never surpass the maximum authorised weight for the roof, the maximum authorised weight on the axles and the total maximum authorised weight of the vehicle.
- Never exceed the capacity of the roof carrier system even if this is less than the maximum authorised roof load.

- Secure heavy items as far forward as possible and distribute the vehicle load uniformly.

### WARNING

Loose and incorrectly secured loads can fall from the roof carrier system causing accidents and injury.

- Always use suitable ropes and straps in good condition.
- Always secure loads correctly.

## Air conditioning

### Heating, ventilation and air conditioning system

#### Introduction

#### Dust and pollen filter

The dust and pollen filter with its activated charcoal cartridge serves as a barrier against impurities in the interior ambient air.

For the air conditioner to work with maximum efficiency, the dust and pollen filter must be replaced at the intervals specified in the Maintenance Programme.

If the filter loses efficiency prematurely due to use in areas with very high levels of air pollution, the filter must be changed more frequently than stated in the Service Schedule.

#### WARNING

Reduced visibility through the windows increases the risk of serious accidents.

- Ensure that all windows are free of ice and snow and that they are not fogged up preventing a clear view of everything outside.
- The maximum heat output required to defrost windows as quickly as possible is only available when the engine has reached its normal running temperature. Only drive when you have good visibility.
- Always ensure that you use the heating system, ventilation, air conditioner and the heated rear window to maintain good visibility.
- Never leave the air recirculation on for a long period of time. If the cooling system is switched off and air recirculation mode switched on, the windows can mist over very quickly, considerably limiting visibility.
- Switch air recirculation mode off when it is not required.

#### WARNING

Stuffy or used air will increase fatigue and reduce driver concentration possibly resulting in a serious accident.

- Never leave the fresh air fan turned off or use the air recirculation for long periods of time; the air in the vehicle interior will not be refreshed.

#### CAUTION

- Switch the air conditioner off if you think it may be broken. This will avoid additional damage. Have the air conditioner checked by a specialised workshop.
- Repairs to the air conditioner require specialist knowledge and special tools. SEAT recommends taking your car in for technical service.

#### Note

- When the cooling system is turned off, air coming from the outside will not be dried. To avoid fogging up the windows, SEAT recommends leaving the cooler (compressor) on. To do this, press the  button. The button lamp should light up.
- The maximum heat output required to defrost windows as quickly as possible is only available when the engine has reached its normal running temperature.
- Keep the air intake slots in front of the windscreen free of snow, ice and leaves to ensure heating and cooling are not impaired, and to prevent the windows from misting over.

## Controls

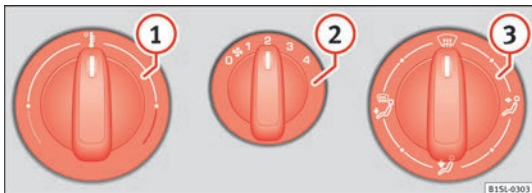

Fig. 76 In the centre console: Heating and ventilation system rotary control

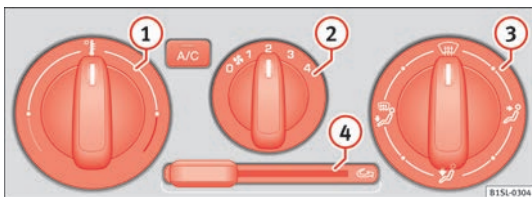







Fig. 77 In the centre console: Air conditioning system controls

Control button	Additional information. Heating and ventilation system »» Fig. 76 and air conditioning system »» Fig. 77.
① Temperature	Rotate the control to adjust the temperature accordingly.
② Fan	Setting 0: fan and manual air conditioning switched off. Setting 4: maximum fan level.
③ Air distribution	Rotate the continuous control to direct the airflow to the desired area.
	<b>Heating and ventilation system:</b> defrost function. Distribution of air to the windscreen and the side windows in the exterior rear vision mirror area. <b>Air conditioning system:</b> defrost function. Distribution of air to the windscreen and the side windows in the exterior rear vision mirror area. Press the <b>A/C</b> button, increase the fan speed and switch on air recirculation »» page 84 to clear the windscreen of condensation as soon as possible.
	Air distribution towards the body.
	Air distribution towards the footwell.



## Operation

Control button	Additional information. Heating and ventilation system » Fig. 76 and air conditioning system » Fig. 77.
	Air distribution towards the windscreen and the footwell.
<b>A/C</b>	<b>Air conditioner:</b> press the button to turn off/on the cooling system » page 82.
	<b>Air conditioner:</b> sliding control for air recirculation » page 84.
Switching off	Turn the air fan switch  to position 0.

### Heated rear window

The heated rear window button  is located on the centre console. The heated rear window only works when the engine is running and switches off automatically after a maximum of 10 minutes.

#### WARNING

**Never turn off the air fan for a long time or the air in the vehicle interior will not be refreshed.**

- Stuffy or used air will increase fatigue and reduce driver and passenger concentration possibly resulting in a serious accident.



### Heating and ventilation system user instructions

#### Temperature

The desired temperature for the interior cannot be lower than that of the exterior air tem-

perature, as the heating and fresh air system cannot cool or dehumidify the air.

#### Setting for conditions of optimal visibility

- Set the fan » Fig. 76  to setting 1 or 2.
- Turn the temperature control » Fig. 76  to the centre position.
- Open and direct the air outlets in the dash panel » page 83.
- Turn the air distribution control » Fig. 76  to the required position.

#### User instructions for the air conditioner\*

The interior cooling system only works when the engine is running and the fan is switched on.

The air conditioning operates most effectively with the windows closed. However, if the vehicle has heated up after standing in the

sun for some time, the air inside can be cooled more quickly by opening the windows briefly.

#### Setting for conditions of optimal visibility

When the air conditioning is switched on, the temperature and the air humidity in the vehicle interior drop. In this way, when the outside air humidity is high, the windows do not mist over and comfort for the vehicle occupants is improved.

- Disable air recirculation mode » page 84.
- Set the fan to the required setting.
- Turn the temperature control to the centre position.
- Open and direct the air outlets in the dash panel » page 83.
- Turn the air distribution control to the defrost position.

- Press the **A/C** button to switch it on. The indicator on the button will light up.

### The cooling system does not switch on

If the air conditioning system cannot be switched on, this may be caused by the following:

- The engine is not running.
- The fan is switched off.
- The air conditioner fuse has blown.

- The outside temperature is lower than approximately +2 °C (+36 °F).
- The air conditioner compressor has been temporarily switched off because the engine coolant temperature is too high.
- Another fault in the vehicle. Have the air conditioner checked by a specialised workshop.

### Things to note

If the humidity and temperature outside the vehicle are high, **condensation** can drip off

the evaporator in the cooling system and form a pool underneath the vehicle. This is normal and does not indicate a leak!

#### Note

**After starting it, any residual humidity in the air conditioner could mist over the windscreen. Switch on the defrost function as soon as possible to clear the windscreen of condensation.**

## Air vents



Fig. 78 Dash panel: Air vents

### Air vents

Never close the air vents »» Fig. 78 **A** completely to ensure heating, cooling and ventilation inside the vehicle.

- To open the air vents press the recess with one slat.
- Change the air direction by turning the slats.
- To close the air vents, fold the slats.

There are additional air vents in the centre of the dash panel and in the footwell area. »»



**ⓘ CAUTION**

Never place food, medicines or other heat-sensitive objects close to the air vents. Being heat-sensitive, they may be damaged or made unsuitable for use by the air coming from the air vents.

**Air recirculation****Important**

Air recirculation mode prevents the ambient air from entering the interior.

When the outside temperature is very high or very low, selecting manual air recirculation mode for a short period refreshes or heats the interior more quickly.

- Switch off air recirculation mode by turning the air distribution control to the    position.

**Switching the air recirculation mode on and off** 

*Switching on:* Move the sliding control **>>> Fig. 77 ④** to the right to maximum.

*Switching off:* Move the sliding control **>>> Fig. 77 ④** to the left to maximum.

**⚠ WARNING**

Stuffy or used air will increase fatigue and reduce driver concentration possibly resulting in a serious accident.

- Never use recirculation mode for long periods as it does not refresh the air inside the vehicle.
- If the cooling system is switched off and air recirculation mode switched on, the windows can mist over very quickly, considerably limiting visibility.
- Switch air recirculation mode off when it is not required.

**ⓘ CAUTION**

Do not smoke when the air recirculation is activated. The smoke taken in could lie on the cooling system vaporiser and on the dust and pollen filter, leading to a permanently unpleasant smell.

**Driving****Steering****Introduction**

The power steering\* is not hydraulic but electromechanical. The advantage of this steering system is that it disposes of hydraulic tubes, hydraulic oil, the pump, filter and other components. The electromechanical system saves fuel. While a hydraulic system requires oil pressure to be maintained, electromechanical steering only requires energy when the steering wheel is turned.

With the power steering system, the assisted steering function automatically adjusts according to the vehicle speed, the steering torque and the wheel turning angle. The power steering only works when the engine is running.





**⚠ WARNING**

If the power steering is not working then the steering wheel is much more difficult to turn and the vehicle more difficult to control.

- The power steering only works when the engine is running.
- Never allow the vehicle to move when the engine is switched off.
- Never remove the key from the ignition if the vehicle is in motion. The steering may

**lock and it will not be possible to turn the steering wheel.**

## Control and warning lamps

It lights up	Possible cause	Solution
 (red)	Power steering faulty.	The steering system should be checked by a specialised workshop as soon as possible.
 (yellow)	Power steering operation reduced.	The steering system should be checked by a specialised workshop as soon as possible. If, after restarting the engine and driving for a short distance, the yellow warning lamp no longer comes on, it will <b>not</b> be necessary to take the vehicle to a specialised workshop.
Flashes	Possible cause	Solution
 (red)	Fault in the steering column electronic lock.	 <b>Do not drive on!</b> Seek professional advice.

Flashes	Possible cause	Solution
	Steering column deviation.	Gently turn the steering wheel to and fro.
 (yellow)	Steering wheel not unlocked or locked.	Remove the key from the ignition and then switch the ignition back on. If necessary, check the messages displayed on the instrument panel display. <b>Do not drive on, if the steering column remains locked after the ignition has been switched on.</b> Seek specialist assistance.

Several warning and control lamps light up for a few seconds when the ignition is switched on, signalling that the function is being verified. They will switch off after a few seconds.

### WARNING

**If the warning lamps are ignored, the vehicle may stall in traffic, or may cause accidents and severe injuries.**

- Never ignore the warning lamps.
- Stop the vehicle safely as soon as possible.

### CAUTION

**Failure to heed the warning lamps when they appear may result in faults in the vehicle.**

## Information on the steering

To prevent theft, we recommend you lock the steering before leaving the vehicle.

### Mechanical steering lock

Lock the steering column by removing the key from the ignition when the vehicle is stopped.

Please engage steering lock	Unlocking the steering
Parking the vehicle » page 89.	Insert the key in the ignition lock.
Remove the key from the ignition.	Turn the steering wheel slightly to release the steering lock.
Turn the steering wheel slightly until you hear the steering lock.	Hold the steering wheel in this position and switch on the ignition.

### Electromechanical power steering

With the power steering system, the assisted steering function automatically adjusts according to the vehicle speed, the steering torque and the wheel turning angle. The power »

steering only works when the engine is running.

You should remember that you will need considerably more power than normal to steer the vehicle if the power steering is not working correctly or not at all.

## Stopping and starting the engine

### Introduction

#### Immobiliser display

When an invalid key is used or in the event of a system fault, **SAFE** is displayed on the instrument panel. The engine cannot be started.

#### Pushing or towing

For technical reasons, the vehicle must **not** be push- or tow-started. Jump starting is preferable.

#### **WARNING**

Switching off the engine while driving makes stopping the vehicle difficult. As a consequence you may lose control of the vehicle and there is a risk of serious accident.

- The assisted braking and steering systems, the airbag system, seat belts and certain

safety equipment are only active while the engine is running.

- The engine should only be switched off when the vehicle is at a standstill.

#### **WARNING**

While the engine is running or starting it could help reduce the risk of serious injury.

- Never start or leave the engine running in poorly ventilated or closed spaces. Exhaust gas contains carbon monoxide, a toxic, colourless and odourless gas. Carbon monoxide can cause people to lose consciousness. It can also cause death.
- Never leave the vehicle unattended if the engine is running. The vehicle could move off suddenly or something unexpected could happen resulting in damage and serious injury.
- Never use start boosters. Cold start sprays could explode or increase the engine speed unexpectedly.

#### **WARNING**

The components of the exhaust system reach very high temperatures. This could cause a fire and considerable damage.

- Always park your vehicle so that no part of the exhaust system can come in contact with flammable materials (such as wood, leaves, spilled fuel, dried grass, etc).

- Never apply additional underseal or anti-corrosion coatings to the exhaust pipes, catalytic converter or the heat shields on the exhaust system.

### Ignition lock

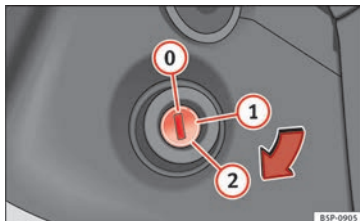

Fig. 79 Vehicle key positions

#### Car keys » Fig. 79

No key in the ignition lock: The steering lock may be activated.

- 0 Ignition switched off. Key can be removed from the vehicle.
- 1 Ignition is switched on. The steering lock can be unlocked.
- 2 Switch on the engine. Release the key when the engine has started. When it is released, the key returns to position 1.

### Key not authorised for the vehicle

If a key which is not authorised for this vehicle is inserted in the ignition lock, it can be removed as follows:

- **Automatic gearbox:** the key cannot be removed from the ignition lock. Press and release the selector lever locking button. Key can be removed from the vehicle.
- **Manual gearbox:** Remove the key from the ignition.

#### WARNING

Unsuitable or careless use of the vehicle key could result in serious injury.

- Always take all the keys with you whenever you leave the vehicle. If not, the engine could accidentally be started and electrical equipment such as the windows could accidentally be operated resulting in serious injury.
- Never leave children or disabled people alone in the car. Passengers could be trapped in the car in an emergency and not be able to get themselves to safety. For example, depending on the time of the year, temperatures inside a locked and closed vehicle can be extremely high or extremely low resulting in serious injuries and illness or even death, particularly for young children.
- Never remove the key from the ignition if the vehicle is in motion. The steering may lock and it will not be possible to turn the steering wheel.

#### Note

- If the key is left in the ignition lock with the engine off for long periods, the vehicle battery will run flat.
- For automatic gearbox vehicles the key can only be removed from the ignition lock if the gear selector lever is in position P. In this case, press and release the selector lever locking button.

### Starting the engine

#### Complete operations only in the sequence given.

1.	Press the brake pedal and keep pressed until step 5 has been completed.
1 a.	<b>In vehicles with a manual gearbox:</b> Press the clutch pedal all the way and keep pressed until the engine starts.
2.	Put the gearbox lever in neutral or the selector lever in position N.
3.	Turn the key in the ignition lock to position <b>» Fig. 79 (2)</b> ; do not press the accelerator.
4.	When the engine has started, release the key in the ignition lock.
5.	If the engine does not start, stop the process and try again after one minute.
6.	Release the handbrake when you want to begin driving <b>» page 89</b> .

#### WARNING

Never leave the vehicle unattended if the engine is running. The vehicle could move off suddenly, especially if it is in gear, resulting in an accident and serious injury.

#### WARNING

Cold start sprays could explode or cause a sudden increase in the engine speed.

- Never use start boosters.

#### CAUTION

- An attempt to start the engine while driving or starting the engine immediately after turning it off can cause damage to the engine or starter motor.
- When the engine is cold, avoid high revs and heavy acceleration and do not make the engine work hard.
- Do not push or tow start the engine. Unburnt fuel could damage the catalytic converter.

#### For the sake of the environment



Do not warm the engine at idle speed; start driving immediately if the visibility is OK. This helps the engine reach operating temperature faster and reduces emissions. **»**

**Note**

- Electrical devices with a high power consumption are switched off temporarily when the engine starts.
- When the engine is started cold, there may be strong vibrations for a few moments for technical reasons. This is quite normal, and no cause for concern.
- Natural gas engines always start up with petrol, as a certain operating temperature is required for running with gas. Once the required operating temperature is reached, the engine will change to operate with natural gas.

**Stopping the engine**

Complete operations only in the sequence given.

1.	Stopping the vehicle completely » »  .
2.	Press the brake pedal and keep pressed until step 4 has been completed.
3.	In automatic gearboxes, put the selector lever in position <b>D</b> or <b>R</b> .
4.	Apply the handbrake firmly » » page 89.
5.	Turn the key in the ignition lock to position » » <b>Fig. 79</b>  .
6.	With a manual gearbox, put the vehicle in first or reverse gear.

**WARNING**

Never switch off the engine while the vehicle is moving. You may lose control of the vehicle and there is a risk of serious accident.

- The airbags and belt tensioners do not work when the ignition is switched off.
- The brake servo does not work with the engine off. To stop, the brake pedal must be pressed with more force.
- As the power steering does not work if the engine is not running, you will need more strength to steer than normally.
- If the key is removed from the ignition, the steering may lock and it will not be possible to steer the vehicle.

**CAUTION**

If the engine has been driven at high speed for a prolonged period of time, it may overheat when turned off. To avoid engine damage, allow the engine to run for approximately 2 minutes in neutral before switching it off.

**Note**

After stopping the engine, the engine compartment fan may continue running for a few minutes, even when the ignition has been switched off or the key removed. The radiator fan is automatically switched off.

**Electronic immobiliser**

The gear lock prevents the engine from being started with an unauthorised key and the vehicle being moved.

The vehicle key has a built-in chip. It automatically deactivates the electronic immobiliser when the key is inserted into the ignition lock.

The electronic immobilizer will be activated again automatically as soon as you remove the key from the ignition lock.

For this reason, the vehicle can only be used with a genuine SEAT key with the correct code. Coded keys can be obtained from SEAT dealerships » » page 43.

If an unauthorised key is used, the signal **SAFE** appears on the instrument panel display. The vehicle cannot be started in this case

**Note**

The correct operation of the vehicle is only guaranteed when original SEAT keys are used.

## Braking and parking

### Introduction

The **assisted braking systems** are the electronic distribution of the brake force (EBV), the anti-lock brake system (ABS), the brake assist system (BAS), the electronic differential lock (EDL), the traction control (TC), the traction control system (ASR) and the electronic stability control (ESC\*).

#### WARNING

Driving with worn brake pads or a faulty brake system may lead to serious accident.

- If you believe the brake pads to be worn or the brake system to be faulty, immediately refer to a specialised workshop to check the brake pads and replace the worn ones.

#### WARNING

Careless parking can cause serious injury.

- Never remove the key from the ignition if the vehicle is in motion. The steering lock may engage and lock the steering wheel making the vehicle impossible to control.
- Always park your vehicle so that no part of the exhaust system can come in contact with flammable materials (such as wood, leaves, dried grass, spilled fuel, etc.).
- Always apply the handbrake when you leave your vehicle and when you park.

- Never leave children or disabled people alone in the vehicle. They could release the electronic parking brake, activate the selector lever or gear stick and start the vehicle moving. This could result in a serious accident.











- Always take all the keys with you whenever you leave the vehicle. The engine could accidentally be started and electrical equipment such as the windows could accidentally be operated resulting in serious injury.





- Never leave children or disabled people alone in the car. They could be trapped in the car in an emergency and will not be able to get themselves to safety. For example, depending on the time of the year, temperatures inside a locked and closed vehicle can be extremely high or extremely low resulting in serious injuries and illness or even death, particularly for young children.



#### CAUTION

- Special care should be taken when parking in areas with high kerbs or fixed barriers. Objects protruding from the ground may damage the bumper or other parts of the vehicle during manoeuvres. To avoid damage, stop before the wheels touch the barrier or kerb.
- Special attention is required when driving through entrances, over ramps, kerbs or other objects. The vehicle underbody, bumpers, mudguards and running gear, and the engine and exhaust system could be damaged as you drive over these objects.

## Warning and control lamps

It lights up	Possible cause » 	Solution
	Handbrake applied.	» page 90.
	Fault in the brake system	 <b>Do not drive on!</b> Seek professional advice » page 92.
	Brake fluid level inadequate.	 <b>Do not drive on!</b> Check brake fluid level » page 153.
	Together with the ABS control lamp  : ABS and EBV do not function.	 <b>Do not drive on!</b> Seek professional advice » page 92.
	ESC* disconnected by system.	Switching the ignition on and off if necessary, drive for a short distance.
	Fault in ESC*.	Contact a specialised workshop.
	Together with the ABS control lamp  : Fault in the ABS.	Contact a specialised workshop. The vehicle can be braked without ABS.
	The battery has been reconnected.	» page 154.
	Traction Control faulty or switched off by the system.	Contact a specialised workshop.

It lights up	Possible cause	Solution
	Together with the ESC* control lamp  : Fault in the ABS.	Contact a specialised workshop. The vehicle can be braked without ABS.
	Together with the warning lamp  : ABS and EBV do not function.	 <b>Do not drive on!</b> Seek professional advice  page 92.

Flashes	Possible cause	Solution
	ESC* or ASR regulating.	Take your foot off the accelerator. Adjust your driving style to the road conditions.
	Traction Control regulator operating.	Take your foot off the accelerator. Adjust your driving style to the road conditions.

Several warning and control lamps light up for a few seconds when the ignition is switched on, signalling that the function is being verified. They will switch off after a few seconds.

 **WARNING**





If the warning lamps are ignored, the vehicle may stall in traffic, or may cause accidents and severe injuries.

- Never ignore the warning lamps.

- Stop the vehicle safely as soon as possible.

 **WARNING**

Driving with brakes in bad condition could result in a serious accident.

- If the brake warning lamp  does not go out, or if it lights up when driving, the brake fluid level in the reservoir is too low or there is a fault in the brake system. Obtain professional assistance immediately  page 152, Checking the brake fluid level.
- If the brake warning lamp  lights up together with the ABS warning lamp , the regulation function of the ABS could be malfunctioning. As a result, the rear wheels can lock relatively easily when braking. If the rear wheels lock this could result in loss of vehicle control! If possible, reduce your speed and drive carefully to a specialised workshop close by to check the brake system. During the following journey, avoid sudden braking and manoeuvres.
- If the ABS warning lamp  does not go out or if it lights while driving, the ABS is malfunctioning. The vehicle can only be stopped using normal braking without ABS. The protection provided by the ABS is not available. Visit a specialised workshop as soon as possible.

 **CAUTION**



Failure to heed the warning lamps when they appear may result in faults in the vehicle.

## Handbrake



Fig. 80 Between the front seats: handbrake.

### Using the handbrake

- Pull firmly in an upwards direction on the handbrake lever while pressing the button.
- The handbrake is applied when the control lamp  lights up on the instrument panel  page 89 when the ignition is switched on.

### Releasing the handbrake

- Pull gently in an upwards direction on the handbrake lever and press the lock button  Fig. 80 (arrow).
- Move the handbrake lever downwards keeping the lock button pressed.

 **WARNING**

The incorrect use of the handbrake may result in a serious accident.

- Never use the handbrake to brake the vehicle except in an emergency. The braking distance is considerably longer, because braking is only applied to the rear wheels. Always use the foot brake.
- Never drive with the handbrake gently applied. This can overheat the brake, affecting the brakes system. This also causes premature wear on the rear brake pads.
- Never accelerate from the engine compartment with the engine running and a gear engaged. The vehicle could move, even if the handbrake is applied.

#### Note

If the vehicle moves at a speed superior to 6 km/h (4 mph) with the handbrake applied, an audible warning is sounded.

## Parking

When parking your vehicle, all legal requirements should be observed.

### To park the vehicle

Complete operations only in the sequence given.

- Park the vehicle on a suitable surface »»» ⚠.
- Press and hold the brake pedal until the vehicle comes to a standstill.
- Apply the handbrake firmly »»» page 90.

- For an automatic gearbox, move the selector lever to position P.
- Switch off the engine and release the brake pedal.
- Remove the key from the ignition.
- If necessary, turn the steering wheel slightly to lock the steering.
- With a manual gearbox, engage 1st gear on flat ground and slopes, or even reverse gear on hills, and release the clutch pedal.
- Ensure that all passengers leave the vehicle, especially children.
- When leaving the vehicle, take all keys with you.
- Lock the vehicle.

### Additional information for steep slopes and hills

Before switching off the engine, rotate the steering wheel so that if the vehicle should move, it will be held by the kerb.

- On slopes, turn the front wheels so that they are against the edge of the kerb.
- Uphill, turn the wheels towards the centre of the road.

#### ⚠ WARNING

The components of the exhaust system reach very high temperatures. This could cause a fire and considerable damage.

- Always park your vehicle so that no part of the exhaust system can come in contact with flammable materials (such as wood, leaves, dried grass, or spilled fuel).

#### ⓘ CAUTION

- Special care should be taken when parking in areas with high kerbs or fixed barriers. Objects protruding from the ground may damage the bumper or other parts of the vehicle during manoeuvres. To avoid damage, stop before the wheels touch the barrier or kerb.
- Special attention is required when driving through entrances, over ramps, kerbs or other objects. The vehicle underbody, bumpers, mudguards and running gear, and the engine and exhaust system could be damaged as you drive over these objects.

## Information about the brakes

For the first 200 to 300 km, the **new brake pads** have not yet reached their maximum braking capacity, and need to be “run in” first »»» ⚠. The slightly reduced braking effect can be compensated for by increasing pressure on the brake pedal. **While running in, the full braking distance or emergency braking distance is larger** than when the brake pads have been run in. While running in, avoid full power braking or situations requiring braking performance. For example, in heavy traffic.

The **rate of wear of the brake pads** depends to a great extent on the conditions in which the vehicle is used and the way the vehicle is driven. If the vehicle is used frequently in city traffic or for short trips or driven sport style, visit a specialised workshop regularly, more frequently than advised in the Maintenance Programme, to have the brake pads checked.

If you drive with **wet brakes**, for example, after crossing areas of water, in heavy rainfall or even after washing the car, the effect of the brakes is lessened as the brake discs are wet or even frozen (in winter). At higher speed, “dry” the brakes as quickly as possible by braking gently several times. Only do this without endangering vehicles behind you or any other road users »» » ⚠.

A **layer of salt on the discs and brake pads** will reduce the effectiveness of the brakes and increase braking distance. If you drive for a prolonged period on salted roads without braking then brake carefully several times to eliminate the layer of salt on the brakes »» » ⚠.

If the vehicle remains parked for considerable lengths of time, is used little, or if the brakes are not used, there may be **corrosion** on the brake discs and a build up of **dirt** on the brake pads. If the brakes are not used frequently, or if rust has formed on the discs, SEAT recommends cleaning the pads and discs by braking firmly a few times at a moderately high speed. Only do this without en-

dangering vehicles behind you or any other road users »» » ⚠.

### Faults in the brake system

During braking, if you notice that the vehicle does not react as usual (that the braking distance has increased suddenly) it may be possible that there is a fault in the braking system. This is indicated by the warning lamp (ⓘ). Take the vehicle to a specialised workshop immediately and have the fault repaired. Drive at a moderate speed and be prepared to use more pressure on the brake pedal, and allow for longer stopping distances.

### Brake servo

The brake servo only operates when the engine is running and the pressure applied by the driver on the brake pedal increases.

If the brake servo does not operate or the vehicle must be towed, then the brake pedal will have to be pressed with more force given that the braking distance will be increased when the brake servo does not operate »» » ⚠.

#### ⚠ WARNING

**New brake pads do not brake to full efficiency.**

- For the first 320 km, new brake pads have not yet reached their maximum braking capacity, and need to be “run in” first. For this,

to compensate for reduced braking efficiency the brake pedal will have to be pressed with more force.

- To avoid losing control of the vehicle and causing serious accidents, always take great care when driving with new brake pads.
- When running in new brake pads, always respect the safety distances between you and other vehicles and do not cause situations requiring extreme braking performance.

#### ⚠ WARNING

**When brakes overheat, braking is less efficient and braking distances increase.**

- When driving on slopes, brakes can be overloaded and overheat quickly.
- Reduce speed or change down a gear when faced with steep and long slopes. This allows you to use the engine braking effect and to reduce the strain on the brake system.
- Non-standard or damaged front spoilers could restrict the airflow to the brakes and cause them to overheat.

#### ⚠ WARNING

**Wet, frozen or salt-covered brakes take longer to engage and this increases braking distances.**

- Test the brakes carefully.
- Dry the brakes, free them of ice and salt by braking gently several times, when visibility,

weather, and road and traffic conditions permit.

### ⚠ WARNING

Driving without the brake servo may significantly increase the braking distance and result in a severe accident.

- Never allow the vehicle to move forwards when the engine is switched off.
- If the brake servo does not operate or the vehicle must be towed, then the brake pedal will have to be pressed with more force given that the braking distance will be increased when the brake servo does not operate.

### ⓘ CAUTION

- Never make the brakes “slip” by pressing the pedal gently, if it is not really necessary to brake. Continuously pressing on the brake pedal will heat the brakes. This could significantly reduce braking power, increase braking distance or even result in the total failure of the brake system.
- Reduce speed or change down a gear when faced with steep and long slopes. This allows you to use the engine braking effect and to reduce the strain on the brake system. Otherwise, the brakes may overheat and fail. Only use the brakes to reduce speed or to stop.

### ⓘ Note

Make use, when having the front brake pads checked, and have the rear pads checked also. The thickness of the brake pads should be checked visually and regularly, by looking through the openings in the wheel rims or from underneath the vehicle. If necessary, remove the wheels to check them thoroughly. SEAT recommends taking your car in for technical service.

## Changing gear

### Introduction

When reverse gear is engaged and the ignition is switched on the following takes place:

- Reverse lights light up.
- The rear wiper blade performs one movement when the windscreen wiper is activated.
- If necessary, connect the parking distance warning system.

### ⚠ WARNING



Rapid acceleration can cause loss of traction and skidding, especially on slippery ground. This could cause loss of control of the vehicle resulting in an accident and considerable damage.

- Use rapid acceleration only when visibility, weather, road conditions and traffic permit.

### ⚠ WARNING

Do not allow the brakes to “rub” for a prolonged period of time, or brake frequently or for long periods of time. Continuous braking heats up the brakes. This could significantly reduce braking power, increase braking distance or even result in the total failure of the brake system.

### Warning and control lamps

 (red)	<b>It lights up</b>  Fault in the automatic gearbox. <ul style="list-style-type: none"> <li>• <b>Do not drive on!</b> Seek professional advice. Failure to do so could result in considerable damage to the transmission</li> <li>» page 97.</li> </ul>
 (yellow)	<b>It lights up</b>  In the automatic gearbox the gears can engage incorrectly. <ul style="list-style-type: none"> <li>• Switch the ignition on and off. When the control lamp does not light up, find the nearest specialised workshop and have the automatic gearbox checked.</li> </ul>



⚠ (yellow)	It lights up
The automatic gearbox overheats temporarily.	Let the transmission cool with the gearbox lever in the position <b>N</b> . When the control lamp does not light up, find the nearest specialised workshop and have the automatic gearbox checked.

Ⓝ	It lights up
Place the automatic gearbox lever in the position <b>N</b> and do not press the brake pedal.	Press the brake pedal to select a gear range.

Together with the yellow control lamp for the temperature of the transmission ⚠: the automatic gearbox overheats.	Press brake pedal and let the transmission cool. Avoid pressing the accelerator. When the control lamp does not light up, find the nearest specialised workshop and have the automatic gearbox checked.
---	---

Together with the turn signal display in the instrument panel display: the automatic gearbox lever is not in the position <b>N</b> , indication to start the engine.	Move the gearbox lever to the position <b>N</b> and start the engine.
--	---

Ⓝ	Flashes
An automatic gearbox in the vehicle does not guarantee that the vehicle will not roll away.	Apply the handbrake.

N	Flashes
In the instrument panel display, in addition to the control lamp requesting the brake pedal to be pressed Ⓝ: indicated for starting the engine.	Move the gearbox lever to the position <b>N</b> and start the engine.

On the instrument panel display: Whilst driving in a forward direction, try to move the automatic gearbox lever to the position <b>R</b> .	Stop the vehicle and move the gearbox lever to the position <b>N</b> in order to subsequently change to the position <b>R</b> .
--	---

On the instrument panel display: The automatic gearbox lever was placed in the position <b>R</b> or <b>D</b> , but the brake pedal was not pressed.	Press the brake pedal, move the gearbox lever to the position <b>N</b> , and subsequently to the required position <b>R</b> or <b>D</b> .
---	---

When switching on the ignition some warning and control lamps light up for a short time to check the operations. They will switch off after a few seconds.

### Manual gearbox: engaging gears

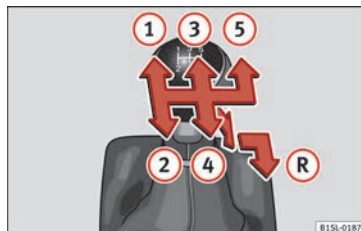

**Fig. 81** Gear shift pattern of a 5-speed manual gearbox

The position of each of the gears is shown on the gear stick » **Fig. 81**.

- Keep the clutch pedal pushed all the way down.
- Move the gearbox lever to the required position » **△**.
- Release the clutch pedal to engage clutch.

In some countries, it is necessary to press the clutch pedal to the floor to start the engine.

#### Selecting reverse gear

- Engage reverse gear only when the vehicle is stopped.
- Keep the clutch pedal pushed all the way down » **△**.

- Place the gearbox lever into neutral and push the lever downwards.
- Slide the gearbox lever to the right, and then backward as shown on the lever.
- Release the clutch pedal to engage clutch.

### Shifting down a gear

Shifting down a gear while driving must be carried out gear by gear, i.e. to the gear immediately preceding the current gear and at an engine speed that is not excessive » » ⚠. At high speeds, or high engine speeds, skipping one or various gears when shifting down a gear can cause damage to the clutch and the gearbox, even if the clutch is not engaged during the process » » ⚠.

#### ⚠ WARNING

When the engine is running, the vehicle will start to move as soon as a gear is engaged and the clutch released.

- Never engage the reverse gear when a vehicle is moving forward.

#### ⚠ WARNING

As a consequence of shifting down a gear incorrectly, you may lose control of the vehicle and cause an accident with serious consequences.

#### ⚠ CAUTION

If, at high speeds or high engine speeds, the gear lever is shifted down to a gear that is too low, serious damage can be caused to the clutch and gearbox. This may also happen if you press the clutch pedal and it does not engage.

#### ⚠ CAUTION

To prevent damage and avoid premature wear, please observe the following:

- While driving, do not leave your hand resting on the gear stick. The pressure applied by your hand is transmitted to the gearbox selector forks.
- Always ensure that the vehicle is completely stopped before engaging the reverse gear.
- When changing gear, always make sure the clutch pedal is pushed right to the floor.
- Never hold the vehicle "on the clutch" on hills with the engine on.

### Automatic gearbox: engaging a gear

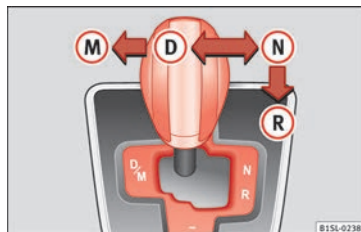

Fig. 82 Automatic gearbox diagram of gears

To move the gear selector lever from the position **N** to **D** or to **R**, first press and hold the brake pedal.

In the instrument panel display, with the ignition switched on, the selected gear range or the gear engaged in the gearbox is shown.

Posi-tions	Denomi-nation	Meaning » » ⚠
<b>R</b>	<b>Reverse gear</b>	Reverse gear is selected. Engage only when the vehicle is stopped.
<b>N</b>	<b>Neutral</b>	The gear box is in neutral. No movement is transmitted to the wheels and the engine does not act as a brake.

»

Positions	Denomination	Meaning »» ⚠
<b>D</b>	Standard driving position	The gears are changed (up and down) automatically. The gear shifts are determined by the engine load, your individual driving style and the speed of the vehicle.
<b>M</b>	Tiptronic driving position (manual shift programme)	All gears can be changed (up and down) manually »» page 96. This is possible as long as the system is not changing gear automatically due to a traffic situation.

### ⚠ WARNING

Placing the selector lever in an incorrect position may cause loss of control of the vehicle and a serious accident.

- Do not press the accelerator when engaging a range of gears.
- With the engine running and a gear range selected, the vehicle will move off when the brake pedal is released.
- Never engage reverse gear while driving.
- Unintentional movements of the vehicle could cause serious injury.
- As a driver, you should never leave your vehicle if the engine is running and a gear range is engaged. If you have to leave your vehicle while the engine is running, you must always apply the handbrake and put the selector lever in position N.

- Never engage the R gear range when the vehicle is moving.
- Never leave the vehicle without applying the handbrake. With the engine running the vehicle moves downhill regardless of the gear range selected.

### 📄 Note

If, while driving, the selector lever is accidentally placed in position N, lift your foot off the accelerator. Wait until the engine is running at idle speed before selecting a new gear range.

### Engaging gear with Tiptronic

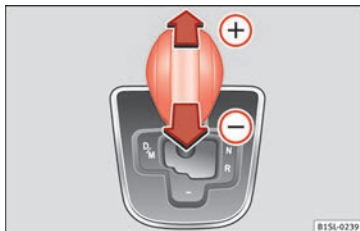

Fig. 83 Lever in the Tiptronic position

With Tiptronic, the gears can be changed up or down manually with the automatic gearbox. When you change to the Tiptronic programme, the vehicle remains in the currently

selected gear. This is possible as long as the system is not changing gear automatically due to a traffic situation.

### Using Tiptronic

- Place the lever in the position **D** to the left on the Tiptronic shift gate **M** »» ⚠ in Automatic gearbox: engaging a gear on page 96.
- Press the lever forwards (+) or backwards (-) to move up or down a gear »» Fig. 83.
- Place the lever back to the position **M** to the left on the Tiptronic shift gate, to leave Tiptronic mode »» ⚠ in Automatic gearbox: engaging a gear on page 96.

With the lever in the position **D**, and pressing forwards (+) or backwards (-) the Tiptronic programme can be selected **M**.

### ⚠ CAUTION

- When accelerating, the gearbox automatically shifts up into the next gear shortly before the maximum engine speed is reached.
- When reducing speed manually, the gear box only shifts gear when the engine can no longer exceed the maximum engine speed.

### Driving with an automatic gearbox

The gearbox changes gear ratios automatically as the vehicle moves.

## Driving down hills

The steeper the gradient, the lower the gear you will need to select. The lowest gears increase the engine braking work. Never go down hills with the selector lever in neutral **N**.

- You should reduce speed accordingly.
- Place the lever in the position **D** to the left on the Tiptronic shift gate **M** » page 96.
- Gently pull the selector lever back  to change down a gear.

## Starting when going up a slope

The steeper the gradient, the lower the gear you will need.

When stopping on a slope with a gear range engaged, the vehicle must be prevented from rolling backwards by always pressing the brake pedal or pulling the handbrake lever up. When starting, release the brake pedal or the handbrake » .

## Kick-down

The kickdown system provides maximum acceleration when the gear selector lever is in the position **D**, or in the Tiptronic position **M**.

When the accelerator pedal is pressed right down, the automatic gearbox will shift down to a lower gear, depending on road speed and engine speed. This takes advantage of

the maximum acceleration of the vehicle » .

When the accelerator is pressed to the floor, the automatic gearbox shifts to the next gear only after the engine reaches the specified maximum engine speed.

### WARNING

**Rapid acceleration can cause loss of traction and skidding, especially on slippery ground. This could cause loss of control of the vehicle resulting in an accident and serious injury.**

- Always adapt your driving style to suit the flow of traffic.
- Only use the kick-down function or rapid acceleration if visibility, weather, road and traffic conditions so permit.
- Never put other road users in danger by accelerating or with your driving style.

### CAUTION

**If you stop on a hill with a gear range engaged, do not try to prevent the vehicle from rolling back by pressing on the accelerator. Otherwise, the automatic gearbox may overheat causing damage.**

## Automatic gearbox malfunction



### Back-up programme

When automatic gearbox warning and control lamps light up on the instrument panel, there may be a system malfunction » page 93. In the event of some faults the automatic gearbox functions using a backup programme. When the programme is activated, it is possible to drive the vehicle, however, at low speeds and within a selected range of gears.

With the manual gearbox, in some cases it is **not possible to drive with all the gears**.

In all cases the automatic gearbox must be checked at a specialised workshop.

### Automatic gearbox overheating

The automatic gearbox can overheat with a prolonged start up, or when stopping and starting continuously. This overheating is displayed with a warning lamp  in the instrument panel. Additionally, an audible warning can be heard. Stop and let the gearbox cool » .

### The vehicle moves forward or back despite having selected a gear range

When the vehicle does not move in the required direction, the system may not have the gear range correctly engaged. Press the brake pedal and engage the gear range again. If the vehicle still does not move in the »



required direction, there is a system malfunction. Seek specialist assistance and have the system checked.

**ⓘ CAUTION**

- When the gearbox is displayed as overheating for the first time, the vehicle must be parked safely or must be driven at a speed of more than 20 km/h (12 mph).
- When the warning lamp lights up and the audible warning is heard, the vehicle must be parked safely and the engine switched off. Let the gearbox cool down.
- To prevent damage to the gearbox, driving must only be continued when the warning lamps are no longer lit up. While the gearbox is overheated, starting up and driving, even at a slow speed should be avoided.

**Recommended gear display**

In some vehicles, the recommended gear for reducing fuel consumption is displayed on the instrument panel:

Display	Meaning
	Optimum gear.
	Recommendation to change up a gear.
	Recommendation to change down a gear.

**⚠ WARNING**

The recommended gear display is intended as a guideline only; it should never replace the driver's attention to driving carefully.

- Responsibility for selecting the correct gear for each situation continues to lie with the driver, for example when overtaking or climbing a hill.

**♻ For the sake of the environment**

Selecting the most appropriate gear for the situation will help you to save fuel.

**ℹ Note**

- The recommended gear display is switched off when the clutch pedal is pressed.
- On the display of the Portable Navigation System (supplied by SEAT) »» page 123 the recommended gear can also be seen.

**Run-in and economical driving**

**Running-in**

Please observe the instructions for running-in new components.

**Running-in the engine**

The engine needs to be run in over the first 1,500 km. During its first few hours of run-

ning, the internal friction in the engine is greater than later on when all the moving parts have bedded down.

How the vehicle is driven for the first 1,500 km influences the future engine performance. Throughout the life of the vehicle, it should be driven at a moderate speed, especially when the engine is cold, as this will reduce engine wear and increase its useful life. Never drive at extremely low engine speeds. Change down to a lower gear when the engine no longer runs "smoothly". **Up to 1,000 kilometres the following instructions apply:**

- Do not use full throttle.
- Do not force the engine above two thirds of its maximum speed.

**Between 1,000 and 1,500 kilometres, gradually** increase power until reaching the maximum speed and high engine speeds.

**Running in new tyres and brake pads**

- Replacement of wheel rims and new tyres »» page 158
- Notes on the brakes »» page 89

**♻ For the sake of the environment**

**If the engine is run in gently, the life of the engine will be increased and the engine oil consumption reduced.**

## Environmental friendliness

Environmental protection is a top priority in the design, choice of materials and manufacture of your new SEAT.

### Constructive measures to encourage recycling

- Joints and connections designed for easy dismantling
- Modular construction to facilitate dismantling
- Increased use of single-grade materials.
- Plastic parts and elastomers are marked in accordance with ISO 1043, ISO 11469 and ISO 1629.

### Choice of materials

- Use of recycled materials.
- Use of compatible plastics in the same part if its components are not easily separated.
- Use of recycled materials and/or materials originating from renewable sources.
- Reduction of volatile components, including odour, in plastic materials.
- Use of CFC-free coolants.

**Ban on heavy metals, with the exceptions dictated by law (Annex II of ELV Directive 2000/53/EC):** cadmium, lead, mercury, hexavalent chromium.

### Manufacturing methods

- Reduction of the quantity of thinner in the protective wax for cavities.
- Use of plastic film as protection during vehicle transport.
- Use of solvent-free adhesives.
- Use of CFC-free coolants in cooling systems.
- Recycling and energy recovery from residues (RDF).
- Improvement in the quality of waste water.
- Use of systems for the recovery of residual heat (thermal recovery, enthalpy wheels, etc.).
- The use of water-soluble paints.

## Correct economical and ecological driving

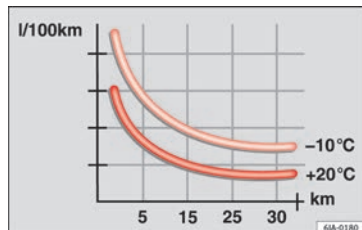

**Fig. 84** Fuel consumption in litres per 100 km at 2 different outside temperatures

Fuel consumption, environmental impact and engine, brake and tyre wear depend largely on three factors:

- Personal driving style.
- Conditions of use (weather, road surface).
- Technical requirements.

Savings of up to 25% in fuel consumption are possible with an appropriate driving style and the adoption of certain simple tips.

### Changing gear early

General instructions: The highest gear is always the most economical. As a guide, for most vehicles at a speed of 30 km/h (19 mph), drive in third gear, at 40 km/h



(25 mph) in fourth gear and at 50 km/h (31 mph) in fifth gear.

In addition, “skipping” gears when shifting up helps to save fuel, weather and traffic conditions permitting.

Do not wait until the last moment before changing gear. Only use first gear when you move off and change to second gear quickly. Avoid the kick-down function in vehicles with automatic gearbox.

Vehicles with a gear display help to achieve an economical driving style as the display indicates the best moment to change gear.

### Let the vehicle roll

If you take your foot off the accelerator, the fuel supply is stopped and consumption is reduced.

Allow the vehicle to roll without accelerating, for example when approaching a red traffic light. However, if the vehicle is rolling too slowly or the distance is too long, the clutch pedal should be pressed to declutch. The engine will then operate at idle speed.

If the vehicle is going to be at a standstill for a period of time, switch off the engine; for example, while waiting at a level crossing.

### Think ahead and “flow” with the traffic

Frequent acceleration and braking considerably increase fuel consumption. If you think

ahead as you drive and keep a safe distance from the vehicle in front, it is possible to slow down by simply lifting your foot off the accelerator. This eliminates the need for constant braking and acceleration.

### Calm and steady driving

Constancy is more important than speed: The more you drive at a constant speed, the lower the fuel consumption.

When driving on the motorway, it is more efficient to drive at a constant and more moderate speed than to be continuously accelerating and braking. As a general rule, you will reach your destination just as quickly when you drive at a constant speed.

The cruise control function helps you to achieve a constant style of driving.

### Moderate use of additional devices

It is important to travel in comfort, but convenience systems should be used ecologically.

Some equipment, when connected, increase fuel consumption considerably, for example:

- Air conditioning cooling system: If the air conditioning system is required to cool to significantly lower temperatures than the true outside temperature, it will require a large amount of energy from the engine. Therefore, we recommend that the selected temperature

for the vehicle is not too different to the outside temperature. It is a good idea to air the vehicle before starting your journey and to drive a short distance with the windows open. Then you can close the windows and switch on the air conditioning. Keep windows closed when travelling at high speeds. Driving with the windows open increases fuel consumption.

- Switch off the seat heating when the seats have warmed up.
- Switch off the heated rear window when it is not moist or covered in ice.

### Avoid short journeys

Fuel consumption is much higher when the engine is cold, immediately after it has been started. It takes a few kilometres of driving for the engine to warm up and to normalise consumption.

The engine and catalytic converter need to reach their proper **working temperature** in order to minimise fuel consumption and emissions. The **ambient temperature** has a decisive influence.

**Fig. 84** shows the difference in consumption for the same journey at +20 °C (+68 °F) and at -10 °C (+14 °F).

Therefore, unnecessary short journeys should be avoided. Try to combine trips.

The vehicle uses more fuel in winter than in summer, even when other conditions are the same.

“Warming” the engine is not only forbidden in some countries, but in practice it is technically superfluous as it is a waste of fuel.

### Adjusting tyre pressures.

Having the correct pressure in your tyres helps to reduce rolling resistance and, as a result reduces fuel consumption. Increasing the tyre pressure slightly (+0.2 bar/+3 psi/+20 kPa) can help to save fuel.

When you buy new tyres, make sure they are optimised for minimum rolling resistance.

### Use low friction engine oil

The use of low viscosity totally synthetic oils, known as low friction engine oil, helps to reduce fuel consumption. These oils reduce the resistance caused by friction in the engine, they flow around the engine more quickly and efficiently, particularly in cold starts. The effect is particularly noticeable in vehicles frequently used for short journeys.

Always check the engine oil level and observe service intervals (engine oil change intervals).

When purchasing engine oil, always observe legal requirements and ensure that the oil is approved by SEAT.

### Avoid carrying unnecessary loads

The lighter the vehicle, the more economical and ecological the driving style. For example, an additional weight of 100 kg will increase fuel consumption up to 0.3 l/100 km.

Remove any unnecessary objects or loads from the vehicle.

### Remove optional equipment and unnecessary accessories

The more aerodynamic the vehicle, the lower the fuel consumption. Optional equipment and accessories (such as roof racks or bike carriers) reduce the aerodynamic benefits of the vehicle.

Therefore, we recommend you remove all optional and unnecessary equipment and racks, especially if you intend to drive at high speeds.

### Other factors which increase fuel consumption (examples):

- Fault in engine management.
- Driving on hills.

#### WARNING

**Always adapt your speed and the distance to the vehicles ahead in line with visibility, weather conditions, the condition of the road and the traffic situation.**

## Engine management and exhaust gas purification system

### Introduction

#### WARNING

The components of the exhaust system reach very high temperatures. This could cause a fire.

- Always park your vehicle so that no part of the exhaust system can come in contact with flammable materials (such as dried grass).
- Never apply additional underseal or anti-corrosion coatings to the exhaust pipes, catalytic converter or the heat shields on the exhaust system.

### Control lamps

It lights up	Possible cause	Solution
<b>EPC</b>	Fault in engine management (Electronic Power Control).	Take the vehicle to a specialised workshop as soon as possible and have the engine checked. ➤

It lights up	Possible cause	Solution
	Fault in catalytic converter.	You should reduce speed accordingly. Drive carefully until you reach the next specialised workshop. Have the engine checked there.

Flashes	Possible cause	Solution
	Combustion fault which could damage the catalytic converter.	You should reduce speed accordingly. Drive carefully until you reach the next specialised workshop. Have the engine checked there.

Several warning and control lamps light up for a few seconds when the ignition is switched on, signalling that the function is being verified. They will switch off after a few seconds.

### CAUTION

**Always pay attention to any lit control lamps and to the corresponding descriptions and instructions to avoid damage to the vehicle.**

### Note

While the control lamps  or EPC maintain lit up, the engine will present faults, a higher

**consumption of fuel and a loss of engine power.**

### Catalytic converter

The catalytic converter permits the subsequent treatment of the exhaust gases thus reducing contaminating gas emissions. To ensure a longer working life for the exhaust system and catalytic converter in a petrol engine:

- Always use unleaded petrol.
- Never run the fuel tank completely dry.
- Do not top up with too much engine oil **»» page 146.**
- Do not tow-start the vehicle; use the starter cables **»» page 181.**

If you should notice misfiring, uneven running or loss of power when the car is moving, reduce speed immediately. Have the car inspected by a specialised workshop. If this happens, unburnt fuel can enter the exhaust system and escape into the atmosphere. The catalytic converter can also be damaged by overheating.

### For the sake of the environment

**Even when the emission control system is working perfectly, there may be a smell of sulphur under certain conditions. This de-**

**pends on the sulphur content of the fuel used.**

### Driving abroad

In some countries, certain safety regulations and requirements are in force relating to exhaust gas emissions, which differ from the technical characteristics of the vehicle. Before travelling abroad, SEAT recommends you consult a technical service about the legal requirements and the following points:

- Does the vehicle need technical modifications for driving abroad, for example, adjustment of the headlamps?
- Does the vehicle have all the tools, diagnostics equipment and spare parts required for inspections and repairs?
- Are there any SEAT dealers in the destination country?
- For petrol vehicles: Is unleaded petrol available at the right octane rating?
- For diesel engines: is diesel fuel available with a low sulphur content?
- Are a suitable engine oil (**»» page 146**) and other engine fluids complying with SEAT specifications available in the destination country?

- Will the navigation system fitted at the factory operate correctly in the destination country with the available navigation data?
- Are special tyres required in the destination country?

#### ⓘ CAUTION

**SEAT does not accept liability for any damage to the vehicle due to the use of a lower quality fuel, an inadequate service or the non-availability of genuine spare parts.**

### Driving along flooded roadways

To prevent damage to the vehicle when driving through water, for example, along a flooded road, please observe the following:

- Check the depth of the water before entering the flooded zone. The water should **never** come above the lower edge of the bodywork » ⓘ.
- Do not drive faster than a pedestrian.
- Do not stop in the water, use reverse gear or switch off the engine.
- Oncoming traffic will cause waves which raise the level of the water, making it difficult to cross the water.
- Disconnect the Start-Stop system whenever crossing water.

#### ⚠ WARNING

**When driving through water, mud, melted snow, etc., please remember that due to damp or frozen brake discs and shoes in winter, the braking effect may be delayed, therefore the required braking distance is greater.**

- **“Dry the brakes and remove ice”** by braking carefully. Ensure that you are not endangering other road-users or breaking traffic regulations in the process.
- **After driving through water, avoid sudden sharp manoeuvres.**

#### ⓘ CAUTION

- **Driving through flooded areas may severely damage vehicle components such as the engine, transmission, drive train or electrical system.**
- **Never drive through salt water as salt causes corrosion. Always rinse any parts of the vehicle which have been in contact with salt water.**

## Driver assistance systems

### Braking and stability systems

#### Brake assist systems

The assisted braking systems ESC\*, ABS, EBV, BAS, ASR, TC and EDL only operate when the ignition is switched on. They contribute significantly to increasing active safety.

#### Electronic stability control (ESC)\*

ESC\* reduces the risk of skidding and increases the vehicle stability by braking individual wheels under specific driving conditions. ESC\* detects critical handling situations, such as understeer, oversteer and wheelspin on the driven wheels. The system stabilises the vehicle by braking individual wheels or by reducing the engine torque.

The ESC\* has limits. It is important to realise that ESC\* is also subject to the laws of physics. ESC\* will not be able to deal with all situations with which drivers may be faced. For example, if the road surface changes suddenly then ESC\* will not be useful in all cases. If the vehicle suddenly enters a section covered by water, mud or snow then ESC\* will not provide assistance in the same way as on dry ground. If the vehicle loses its grip on the ground and moves on a film of water (“aquaplaning”), the ESC\* will not be able to help »

the driver control the vehicle due to the loss of adherence with the road surface preventing braking and steering. If the vehicle is driven through series of bends at high speed, the ESC\* will not always be as effective: the vehicle reaction to aggressive driving is not the same as at reduced speeds.

Adjust your speed and driving style to suit visibility, and weather, road and traffic conditions. ESC\* cannot push the limits of the laws of physics; improve the transmission available or maintain the vehicle on the road if a lack of driver attention creates an inevitable situation. Otherwise, ESC\* assists in maintaining vehicle control in extreme situations and uses the movements of the steering made by the driver to maintain the vehicle moving in the desired direction. If the vehicle is driven at such a speed that it will leave the road before ESC\* can intervene then the system cannot provide assistance.

The ABS, BAS, ASR and EDL systems are incorporated into the ESC\*. The ESC\* is always on<sup>1)</sup>.

### Anti-lock brake system (ABS)

ABS can prevent the wheels from locking during braking until just before the vehicle stops thus helping the driver to steer the vehicle and maintain control. This means that, even

during full braking, the risk of skidding is reduced:

- Press and hold the brake pedal fully. Do not remove your foot from the brake pedal or reduce braking force!
- Do not “pump” the brake pedal, or reduce braking force!
- Maintain vehicle direction when braking fully.
- When the brake pedal is released or when the brake force is reduced, ABS is turned off.

ABS control can be observed by **vibration of the brake pedal** and noise. You should never expect the ABS to reduce the braking distance under *any* circumstances. This distance will increase when driving on gravel, recent snow or on icy or slippery ground.

### Brake assist system (BAS)

The brake assist system may reduce the required braking distance. The brake assist system boosts the braking force if you press the brake pedal quickly in an emergency. As a result, the braking pressure increases rapidly, the braking force is multiplied and the braking distance is reduced. This enables the ABS to be activated more quickly and effectively.

Do **not** lift your foot off the brake pedal! When the brake pedal is released or when the brake force is reduced, braking assist automatically turns off the brake servo.

### Traction control system (ASR) or Traction Control (TC)

In the event of wheelspin, the traction control system ASR or TC reduces the engine torque to match the amount of grip available. The ASR or TC makes some situations easier, for example, when starting, accelerating or going uphill, even in unfavourable road conditions.

### Electronic differential lock system (EDL)

EDL is available when driving in straight lines under normal conditions. When the EDL detects wheelspin, it brakes the spinning wheel and directs the power to the other one. To prevent the disc brake of the braked wheel from overheating, the EDL cuts out automatically if subjected to excessive loads. The EDL will switch on again automatically when the brake has cooled down.

#### WARNING

**Driving at high speed on icy, slippery or wet ground can result in loss of vehicle control**

<sup>1)</sup> Depending on the version.

and serious injury to the driver and passengers.

- Adjust your speed and driving style to visibility, road, traffic and weather conditions. Even though the brake assist systems, ABS, BAS, EDL, ASR and ESC\* provide more security, do not take unnecessary risks while driving.
- Brake assist systems can not overcome the laws of physics. Even with ESC\* and other systems, slippery and wet roads will always be dangerous.
- Driving to quickly on wet ground can result in the wheels losing contact with the ground in an effect known as “aquaplaning”. Without adherence, it is impossible to brake, steer or control the vehicle.
- Brake assist systems cannot avoid accidents if, for example, the driver does not respect safety distances or drives to quickly in difficult conditions.
- Even though brake assist systems are extremely effective and help control the vehicle in difficult situations, remember that the vehicle stability depends on tyre grip.
- When accelerating on a slippery surface, for example on ice or snow, press the accelerator carefully. The wheels can still slip even with brake assist systems resulting in loss of vehicle control.

#### WARNING

The effectiveness of the ESC\* can be considerably reduced if other components and systems affecting driving dynamics are not maintained or are not functioning correctly. This includes, among others, brakes, tyres and other systems already mentioned.

- Remember that changing and fitting other components to the vehicle can affect operation of the ABS, BAS, ASR TC, EDL and ESC\*.
- Changes to the vehicle suspension or using unapproved wheel/tyre combinations can affect operation of the ABS, BAS, ASR, TC, EDL and ESC\* and their effectiveness.
- Likewise, the effectiveness of ESC\* depends on the use of suitable tyres  
» page 158.

#### Note

- To ensure that the ESC\*, ASR and TC work properly, all four wheels must be fitted with identical tyres. Any differences in the rolling radius of the tyres can cause the system to reduce engine power when this is not desired.
- If a malfunction should occur in the ABS, the ESC\*, ASR, TC and EDL will also be affected.
- Noises may be heard while any of the above systems are operating.

## Parking sensor system\*

### Introduction

The parking sensor system assists the driver when parking. If the rear of the vehicle is approaching an obstacle, an intermittent audible warning is emitted. The shorter the distance, the shorter the intervals between tones. If the vehicle is too close to the obstacle, the audible warning becomes constant.

If you continue to approach an obstacle when the sound is continuous, this means the system can no longer measure the distance.

Sensors situated on the rear bumper transmit and receive ultrasound. Using the ultrasound signal (transmission, reflection from the obstacles and reception), this system continuously calculates the distance between the bumper and the obstacle.

#### WARNING

The parking distance warning system cannot replace the driver's assessment of the situation.

- The sensors have blind spots in which obstacles and people are not registered.
- Always observe the area around the vehicle, as the sensors do not always detect small children, animals or objects.



- The surface of certain objects and some clothing do not reflect the ultrasound signals from the parking distance system. The system cannot detect or incorrectly detects these objects and people wearing these types of clothes.
- External sound sources can affect the parking distance aid signals. In this case, under certain circumstances, people and objects will not be detected.

### ⓘ CAUTION

- The sensors may not always be able to detect objects such as trailer draw bars, thin rails, fences, posts, trees and open boots, etc. This could result in damage to your car.
- Although the parking sensor system detects and warns of the presence of an obstacle, the obstacle could disappear from the angle of measurement of the sensors if it is too high or low and the system would no longer show it. Therefore, it will not warn you of these objects. Ignoring the warnings of the parking sensor system could cause considerable damage to the vehicle.
- The bumper sensors may become damaged or misaligned, for example, when parking.
- To ensure that the system works properly, the bumper sensors must be kept clean, free of ice and snow and uncovered.
- When cleaning the sensors with high-pressure or steam cleaning equipment, spray the

sensors briefly at a distance of no less than 10 cm.

- Different sources of noise can produce errors in the parking distance warning system, e.g. parking distance warning systems from other vehicles, inductive loops or construction works machines.
- Retrofitting of components to the vehicle, such as a bicycle carrier, may interfere with the function of the parking distance warning system.

### Parking distance warning system

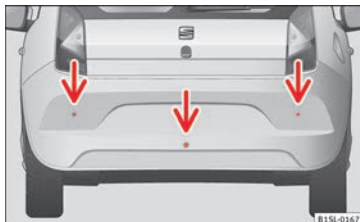

**Fig. 85** Parking distance warning system sensors on the rear bumper

The sensors of the parking distance warning system are situated on the rear bumper

» **Fig. 85.**

### Switching the parking sensor system on and off

- *Switching on:* With the ignition switched on, select reverse gear. A short audible warning confirms that the parking distance warning system is switched on and functioning.
- *Switching off:* Release reverse gear.

### Things to note on the parking distance warning system

- The parking sensor system sometimes registers water on the sensors as an obstacle.
- If the distance does not change, the warning signal will sound less loudly after a few seconds. If the continuous signal sounds, the volume will remain constant.
- When the vehicle moves away from the obstacle, the beeping sound automatically switches off. When getting close again, it re-connects.
- Your SEAT dealership can adjust the volume of the warning signals.

### ⓘ Note

A fault in the parking distance warning system is indicated through a brief audible warning that is constant for about 3 seconds when switching it on the first time. Check the parking distance warning system at a Specialised workshop as soon as possible.

## Optical parking system\* (OPS)

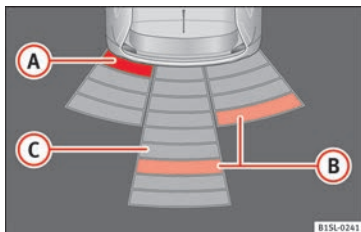

**Fig. 86** On-screen OPS display: **A** has detected an obstacle in the collision zone; **B** has detected an obstacle in the segment; **C** zone recorded behind the vehicle.

The optical parking system is an extension of the parking distance warning system » page 106.

On the screen of the SEAT Portable System (supplied by SEAT) the area behind the vehicle is shown registered by the sensors. Any obstacles are displayed in relation to the vehicle » **△**.

Function	Necessary operations
Switching the display on:	Switching on the » page 106 parking distance warning system. The OPS switches on automatically.
Switching the display off manually:	Press the  button on the Portable Navigation System.

Function	Necessary operations
Switching the display off manually:	Release reverse gear.

### Zones explored

Behind the vehicle » **Fig. 86 C**, the zone analysed reaches a distance of up to 150 cm and around 60 cm to the sides.

### Screen display

The image displayed represents the superimposed zones in several segments. As the vehicle moves closer to an obstacle, the segment moves closer to the vehicle displayed **A** or **B**. When the penultimate segment is displayed, this means that the vehicle has reached the collision zone. **Stop the vehicle!**

Distance from the vehicle to the obstacle	Audible warning	Displayed in colour on the screen: colour of the segment if an obstacle is recognised
behind: approx. <b>31-150 cm</b>	beeping sound	Yellow
behind: approx. <b>0-30 cm</b>	permanent sound	Red

### **△** WARNING

**Do not be distracted from traffic to look at the screen.**

### **i** Note

- SEAT recommends practising using the parking distance warning system in a traffic-free zone or in a car park to familiarise yourself with the system and its operation.
- Representation of the registered area on the screen of the portable navigation system may take up to 5 seconds.
- Note the Instruction Manual provided for the device of the additional information relating to the Portable Navigation System (supplied by SEAT) » page 123.

## Cruise control\* (Cruise control system - CCS)

### Introduction

The cruise control system (CCS) is able to individually maintain the set speed when driving forwards from approx. 20 km/h (15 mph).

The CCS only slows down by reducing the accelerator but not by braking » **△**. »

### WARNING

Use of the cruise control could cause accidents and severe injuries if it is not possible to drive at a constant speed maintaining the safety distance.

- Do not use the cruise control in heavy traffic, if the distance from the vehicle in front is insufficient, on steep roads, with several bends or in slippery circumstances (snow, ice, rain or loose gravel), or on flooded roads.
- Never use the CCS when driving off-road or on unpaved roads.
- Always adapt your speed and the distance to the vehicles ahead in line with visibility, weather conditions, the condition of the road and the traffic situation.
- To avoid unexpected operation of the cruise control system, turn it off every time you finish using it.

- It is dangerous to use a set speed which is too high for the prevailing road, traffic or weather conditions.
- When travelling down hills, the CCS cannot maintain a constant speed. The vehicle tends to accelerate under its own weight. Select a lower gear or use the foot brake to slow the vehicle.

### Control lamp

It lights up	Possible cause
	This cruise control system maintains the set speed of the vehicle.

Several warning and control lamps light up for a few seconds when the ignition is switched on, signalling that the function is being verified. They will switch off after a few seconds.

### WARNING

If the warning lamps are ignored, the vehicle may stall in traffic, or may cause accidents and severe injuries.

- Never ignore the warning lamps.

### CAUTION

Failure to heed the warning lamps when they appear may result in faults in the vehicle.

## Cruise control system operation

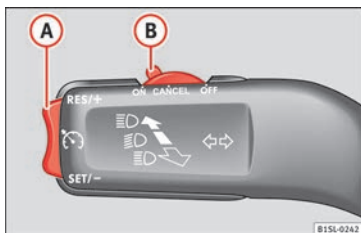

**Fig. 87** Turn signal and main beam headlights lever on the left of the steering column: CCS buttons and controls.

Function	Control position, control operations » Fig. 87	Action
Switch on the CCS.	Control <b>(B)</b> in the position <b>ON</b> .	The system is switched on. After switching on, no speeds are stored and no regulator has yet been placed.
Activating the CCS	Press button <b>(A)</b> in the area <b>SET/-</b> .	The current speed is stored and maintained.
Temporarily switch off CCS	Place control <b>(B)</b> in the <b>CANCEL</b> position. <b>OR:</b> Press the brake or clutch pedal.	The cruise control system is switched off temporarily. The speed setting will remain stored.
Switch on the CCS again.	Press button <b>(A)</b> in the area <b>RES/+</b> .	The stored speed is reached again and maintained.
Increasing the stored speed (during CCS setting)	Press the button <b>(A)</b> in the area <b>RES/+</b> <i>briefly</i> to increase speed in shot measures of about. 1 km/h (1 mph) and store.	The vehicle accelerates actively until it reaches the new stored speed.
	Keep button <b>(A)</b> pressed in the area <b>RES/+</b> <i>for a long time</i> to continually increase speed until releasing and storing.	

»

## Operation

Function	Control position, control operations » Fig. 87	Action
Reducing the stored speed (during CCS setting)	Press the button <b>(A)</b> in the area <b>SET/-</b> briefly to reduce the stored speed in shot measures of about. 1 km/h (1 mph) and store.	Reduce speed <i>without</i> braking, by interrupting the accelerator until reaching the new stored speed.
	Keep button <b>(A)</b> pressed in the area <b>SET/-</b> for a long time to continually decrease stored speed until releasing and storing.	
Switch off the CCS.	Control <b>(B)</b> in the position <b>OFF</b> .	The system is switched off. The stored speed is deleted.

### Travelling down hills with the CCS

When travelling down hills the CCS cannot maintain a constant speed. Slow the vehicle down using the brake pedal and reduce gears if required.

### Automatic off

The cruise control system (CCS) is switched off automatically or temporarily:

- If the system detects a fault that could affect the working order of the CCS.
- If you increase the stored speed by pressing the accelerator pedal for a certain time.
- if the brake or clutch pedal is depressed.
- If the gear is changed with the manual gearbox.
- If the airbag is triggered.

## Safety Assist\* (City Safety Assist function)

### Introduction

The City Safety Assist function covers driving situations at a distance of about 10 metres in front of the vehicle, in a speed range of approximately 5-30 km/h (3-19 mph).

When the system detects a possible collision with a vehicle in front, the vehicle prepares for a possible emergency braking » .

If the driver does not react to an imminent collision, the system can automatically brake the vehicle in order to reduce speed faced with a possible collision. The system can help to reduce the consequences of an accident.

If the City Safety Assist function determines that the driver has braked insufficiently when faced with an imminent collision, the system can increase the brake force in order to re-

duce speed. The system can help to reduce the consequences of an accident.

### WARNING

The smart technology in the City Safety Assist system cannot change the limits imposed by the laws of physics and by the system itself. The increased convenience offered by the City Safety Assist system should never prompt you to take risks. The driver always assumes the responsibility of braking in time.

- The City Safety Assist function cannot prevent accidents or serious injury by itself.
- The City Safety Assist system may carry out unwanted brake interventions in complex driving situations e.g. when a vehicle crosses at a short distance.

### WARNING

Relying on the City Safety Assist system in city driving as part of one's driving behaviour may cause accidents and serious injury. The

system is not a replacement for driver awareness.

- Always adapt your speed and the distance to the vehicles ahead in line with visibility, weather conditions, the condition of the road and the traffic situation.
- The City Safety Assist function does not react to people, animals or vehicles that cross or move in the opposite direction in the same lane.
- If after switching on the City Safety Assist function the vehicle begins to move, slow the vehicle with the foot brake.

#### ⓘ CAUTION

If you suspect that the City Safety Assist radar feature is damaged, switch it off. This will avoid additional damage.

- Any repair of the radar sensor requires specialist knowledge. SEAT recommends taking your car in for technical service.

#### ⓘ Note



- If the City Safety Assist function activates a brake, the brake pedal range is reduced. This makes the brake pedal seem “harder”.
- Automatic brake intervention by the City Safety Assist function can be cancelled by pressing the clutch pedal, the accelerator pedal or by a corrective intervention.
- During automatic braking by the City Safety Assist function you may hear unusual noises.

This is normal and is produced in the brake system.





### Warning and control lamps

The City Safety Assist function is switched on every time the ignition is switched on. No special indication is produced.

If the City Safety Assist function is switched off or on, or if there is an error in the system, it will be shown by a control lamp on the instrument panel display.

It lights up	Possible cause	Solution
 On	The City Safety Assist function has been switched on manually using the button  <b>OFF</b> »» Fig. 90.	The control lamp turns off after about 5 seconds.

Flashes	Possible cause	Solution
	<i>Fast:</i> The City Safety Assist system brakes automatically or has braked automatically.	Control lamp turns off automatically.

Flashes	Possible cause	Solution
	<i>Slow:</i> City Safety Assist function is not currently available.	If the vehicle is stopped, switch off the engine and switch it on again. If necessary, inspect the radar sensor (dirt, frost) »»  <b>Δ</b> in Radar sensor on page 112. If it still does not function, refer to a Specialised workshop to have the system inspected.
 <b>OFF</b>	<i>Within the operating area of 5-30 km/h (3-19 mph):</i> The City Safety Assist function has been switched off manually using the button  <b>OFF</b> »» Fig. 90.	Switch on the City Safety Assist function manually using the button  <b>OFF</b> »» Fig. 90.

Several warning and control lamps should light up for a few seconds when the ignition is switched on, signalling that the function is being verified. They will switch off after a few seconds.

»»

### ⚠ WARNING

If the warning lamps are ignored, the vehicle may stall in traffic, or may cause accidents and severe injuries.

- Never ignore the warning lamps.
- Stop the vehicle safely as soon as possible.

### ⓘ CAUTION

Failure to heed the warning lamps when they appear may result in faults in the vehicle.

### Radar sensor

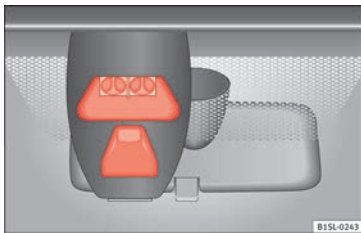

**Fig. 88** In the windscreen: City Safety Assist function radar sensor.

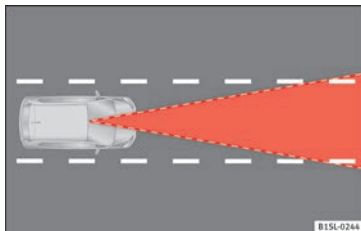

**Fig. 89** Radar sensor detection area.

A radar sensor on the windscreen »» **Fig. 88** allows the system to detect driving situations in front of the vehicle.

Vehicles ahead can be detected up to a distance of about 10 m.

### ⚠ WARNING

The laser beam on the radar sensor can produce serious injuries to the eyes.

- Never focus optical devices, e.g. a camera, a microscope or a magnifying glass closer than 100 mm from the radar sensor.
- Note that the laser beam can stay active when the City Safety Assist system is switched off or unavailable. The laser beam is not visible to the human eye.

### ⓘ CAUTION

If the windscreen is dirty or frosted in the area of the radar sensor, e.g. due to rain, mist

or snow, the City Safety Assist system may fail to operate as a result.

- Always keep the radar sensor area free of dirt and frost.
- Use a small brush to remove snow and a de-icer spray to remove ice.

### ⓘ CAUTION

A damaged windscreen in the radar sensor area may cause the City Safety Assist function to fail to operate.

- Replace the windscreen if it is scratched, cracked or chipped by stones in the radar sensor area. Only use a windscreen authorised by SEAT. Carrying out repairs is not permitted (e.g. in the case of damage suffered in an impact from a stone).
- When replacing the windscreen wipers, only use windscreen wipers authorised by SEAT.
- Do not paint the radar sensor area on the windscreen, or cover it with adhesives or other materials.

## Function

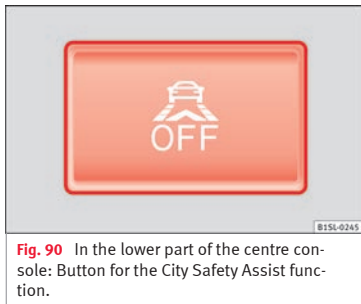

**Fig. 90** In the lower part of the centre console: Button for the City Safety Assist function.

## Switching on and off the City Safety Assist function

- Press the » **Fig. 90** button on the centre console.

When the City Safety Assist function is switched on, the control lamp  **OFF** lights up on the dash panel within the operational range, i.e. for speeds between 5-30 km/h (3-19 mph).

## Switch off the City Safety Assist function in the following situations

Switching off the City Safety Assist function is recommended in the following situations

» :

- While the vehicle is being towed.

- If the vehicle has been taken to an automatic car wash.
- If the vehicle is above a test bed.
- If the radar sensor is faulty.
- After the radar sensor has been involved in a collision.
- When driving off road (overhanging branches).
- If objects are protruding above the bonnet, e.g. a load carried on the roof that significantly protrudes over the front.
- If the windscreen is damaged in the radar sensor area.

 **WARNING**

**Failure to switch off the City Safety Assist function in the above situations may result in accidents and serious injury.**

- **Switch off the City Safety Assist function in critical situations.**

## Special driving situations

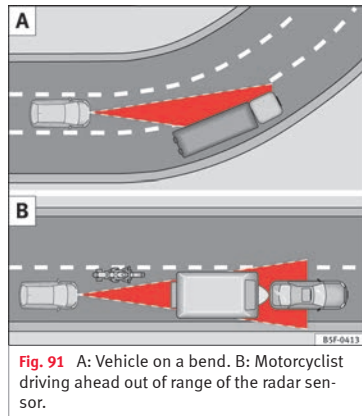

**Fig. 91** A: Vehicle on a bend. B: Motorcyclist driving ahead out of range of the radar sensor.

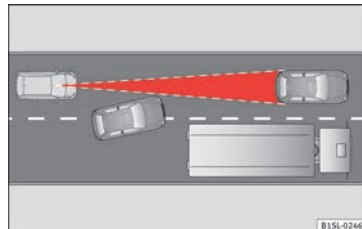

**Fig. 92** Other vehicles changing lanes

The City Safety Assist function is limited by the laws of physics and by the nature of the system itself. For this reason, this may produce reactions from the City Safety Assist system in certain circumstances that are late or unexpected by the driver. For this reason, always pay due attention and if necessary, intervene.

**For example, the following driving situations require special attention:**

#### Driving through a bend

When entering or leaving a “long” bend, the vehicle may decelerate when the radar sensor detects a vehicle travelling in the adjoining lane » **Fig. 91 A**. To interrupt deceleration you can accelerate, turn the steering wheel or press the clutch.

#### Narrow vehicles in front

The radar sensor will only detect narrow vehicles in front if they are in the sensor detection zone » **Fig. 91 B**. This applies especially to narrow vehicles such as motorbikes.

#### Other vehicles changing lanes

Vehicles moving into your lane in close proximity can cause unexpected braking from the City Safety Assist system » **Fig. 92**. To interrupt deceleration you can accelerate, turn the steering wheel or press the clutch.

#### Malfunction in the radar sensor

If the radar sensor operation is impaired, for example due to heavy rain, mist, snow or dirt, the City Safety Assist system function is temporarily switched off. On the instrument panel display the control lamp  flashes.

When the fault in the radar sensor has been rectified, the City Safety Assist system function automatically becomes available. The control lamp  switches off.

#### The following conditions could prevent the City Safety Assist system from functioning:

- Tight bends.
- Accelerator pressed all the way down to the floor.
- If the City Safety Assist system is switched off or there is a fault » **page 111**.
- If the radar sensor is dirty, covered or overheated » **page 112**.
- In the event of snow, heavy rain or dense fog.
- If there are vehicles in front.
- Vehicles changing lanes.
- Vehicles moving in the opposite direction in the same lane.
- Very dirty vehicles with a low degree of reflection.
- Presence of thick dust.

## Hill driving assistant\*

### Operation

This function is only included in vehicles with ESC.

The hill driving assistant helps the driver to move off and upward on a hill when the vehicle is stationary.

The system maintains brake pressure for approximately two seconds after the driver takes his foot off the brake pedal to prevent the vehicle from lurching backward when it is started. During these 2 seconds, the driver has enough time to release the clutch pedal and accelerate without the vehicle moving and without having to use the handbrake, making start-up easier, more comfortable and safer.

These are the basic operation conditions:

- being on a ramp or hill/slope,
- doors closed,
- vehicle completely stationary,
- engine running and foot on the brake,
- besides having a gear engaged or being in neutral for manual gear change and with the selector lever at positions **S**, **D** or **R** in vehicles with an automatic gearbox.

This system is also active when reversing uphill.

**⚠ WARNING**



- If you do not start the vehicle immediately after taking your foot off the brake pedal, the vehicle may start to roll back under certain conditions. Depress the brake pedal or use the hand brake immediately.
- If the engine stalls, depress the brake pedal or use the hand brake immediately.
- When following a line of traffic uphill, if you want to prevent the vehicle from rolling back accidentally when starting off, hold the brake pedal down for a few seconds before starting off.

**i Note**

The Official Service or a specialist workshop can tell you if your vehicle is equipped with this system.

**Start-Stop system****Warning lamps**

It lights up	Possible cause	Solution
	The Start-Stop system is enabled.	

It lights up	Possible cause	Solution
	The Start-Stop system is enabled but the engine cannot be automatically stopped.	Contact a specialised workshop.
	The Start-Stop system cannot start the engine.	Start the engine by hand using the vehicle's key » page 86.
	There is a fault in the alternator.	» page 154

Flashes	Possible cause	Solution
	The Start-Stop system is not available.	Contact a specialised workshop.

Some warning and control lamps will light up briefly when the ignition is switched on to check certain functions. They will switch off after a few seconds.

**⚠ WARNING**

Observe the safety warnings »  in Control and warning lamps on page 40.

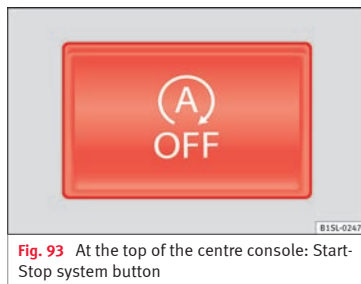
**Start-Stop system**

**Fig. 93** At the top of the centre console: Start-Stop system button

With the Start-Stop system enabled, the engine is automatically stopped when the vehicle is at a standstill. It will start again automatically as required.

This function remains enabled while the ignition is switched on. The instrument panel display shows information on the current status » page 115.

Disconnect the Start-Stop system by hand whenever crossing water.

**Vehicles with a manual gearbox**

- When the vehicle is stopped, put it into neutral and release the clutch pedal. The engine will stop.
- To restart, simply engage the clutch. »

### Vehicles with an automatic gearbox

- When the vehicle is at a standstill, depress the brake or keep it pressed down. The engine switches off.
- The engine will start again as soon as you release the brake pedal.
- With the selector lever set to position **N**, the engine will not start until a range of gears is selected or the accelerator pedal is depressed.

### Important conditions for the engine to stop automatically

- The driver's seat belt must be fastened.
- The driver door must be closed.
- The bonnet must be closed.
- The engine must have reached a minimum temperature.
- The vehicle must have moved since the last time the engine was stopped.
- The vehicle's battery must be sufficiently charged.
- The battery temperature must not be too low or too high.
- The vehicle must not be on a very steep slope.

### Conditions for the engine to restart automatically

The engine can be automatically restarted in the following cases:

- If the vehicle starts to move.
- If the battery voltage drops.

### Conditions requiring engine start-up using the key

The engine has to be manually started in the following cases:

- If the driver unbuckles his/her seat belt.
- If the driver door is opened.
- If the bonnet is opened.

### Switching the Start-Stop system on and off

- Press the button  situated in the centre console **» Fig. 93**.
- The button will light up when the Start-Stop system is switched off.

The engine will start immediately if the vehicle is in Stop mode when the system is switched off by hand.

#### **WARNING**

The smart technology included in the hill hold cannot change the laws of physics. Do not let the extra convenience afforded by the

hill hold tempt you into taking any risks when driving.

- Any accidental movement of the vehicle could result in serious injury.
- The hill hold is not a replacement for driver awareness.
- Adjust your speed and driving style to visibility, weather, road and traffic conditions.
- The hill hold cannot always keep the vehicle at a standstill on a slope or brake sufficiently when travelling downhill (e.g. on slippery or frozen surfaces).

#### **WARNING**

The brake servo and the electromechanical steering do not work when the engine is switched off.

- The vehicle must never be allowed to move with the engine switched off.
- Disconnect the Start-Stop system before working in the engine compartment.

#### **CAUTION**

The vehicle's battery could be damaged if the vehicle is used for long periods at very high outside temperatures.

#### **Note**

In some cases, it may be necessary to start the engine by hand using the key. Refer to

the corresponding control lamp on the instrument panel.

## Towing bracket device

### Trailer coupling

#### Information about trailer coupling

The vehicle is **not** certified for trailer coupling. The vehicle is not factory-equipped with a towing bracket, nor is it possible to retrofit it.

#### WARNING

Installing a towing bracket on the vehicle may cause accidents and serious injuries while operating the vehicle.

- Never install a towing bracket on the vehicle.
- The trailer may be released from the vehicle when the vehicle is moving.

#### CAUTION

Any type of towing bracket installed on the vehicle can cause serious and costly damage that are not covered under the SEAT guarantee.

## Advice

### Care and maintenance

#### Accessories, replacement of parts and modifications

##### Introduction

##### WARNING

The use of spare parts and accessories, or incorrectly performed modifications or repairs may result in damage to the vehicle, accidents and serious injury.

- SEAT strongly recommends you to only use SEAT approved accessories and SEAT® original spare parts. These parts and accessories have been specially tested by SEAT for suitability, reliability and safety.
- Have any repairs or modifications carried out at a specialised workshop. These workshops have the necessary tools, diagnostics equipment, repair information and qualified personnel.
- Only mount parts with the same specifications as the parts fitted at factory.
- Never mount, fasten or fit objects such as drink holders or telephone cradles over the covers of the airbag modules or within their deployment zones.

- Only use wheels and tyre combinations which have been approved by SEAT for your vehicle type.

##### Accessories and spare parts

SEAT recommends you consult an Official Service before purchasing accessories and spare parts or consumables. For example, when fitting accessories at a later date, or when replacing a component. A SEAT Official Service will advise you as to the legal requirements and manufacturer's recommendations regarding accessories, spare parts and other components.

SEAT recommend you use only approved **SEAT accessories** and **genuine SEAT spare parts**®. These parts and accessories have been specially tested by SEAT for suitability, reliability and safety. In addition, SEAT technical services will guarantee that assembly is performed professionally.

Although we continually monitor the market, SEAT cannot guarantee that products **not approved by SEAT** are reliable, safe or suitable for the vehicle. Therefore, SEAT cannot accept liability, even in those cases authorised by an officially recognised technical inspection office or other official body.

Any **retro-fitted equipment** which has a direct effect on vehicle control must be approved by

SEAT for use in your vehicle and bear the **e** mark (the European Union's authorisation symbol). This includes cruise control systems or electronically controlled suspension.

If any **additional electrical devices** are fitted which do not serve to control the vehicle itself, these must bear the **CE** mark (European Union manufacturer conformity declaration). This includes refrigerator boxes, laptops or ventilator fans.

##### WARNING

**Unprofessional repairs or modifications to the vehicle may affect the performance of the airbags, and may cause operating faults or fatal accidents.**

- Never mount, fasten or fit objects such as drink holders or telephone cradles over or next to the covers of the airbag modules or within their deployment zones.
- Objects placed over the airbag covers, or within their deployment zones, could lead to serious injury or loss of life if the airbags are triggered.

##### Fluids and consumables

**All vehicle fluids and consumables**, such as notched belts, tyres, coolant fluids, engine oils, spark plugs and batteries are continually being developed. Therefore all fluids and

consumables should be changed at a specialised workshop. Technical services are permanently informed of any modifications.

### WARNING

The incorrect use or handling of fluids or consumables may result in accident, serious injury, burns or intoxication.

- Therefore, fluids must always be stored closed in their original container.
- Never store fluids in empty food containers or bottles as other people may accidentally drink the fluid.
- Keep all fluids and consumables out of reach of children.
- Read and observe the information and warnings given on the fluid containers.
- Only work in the open air or in well-ventilated zones, when using products which give off harmful vapours.
- Never use fuel, turpentine, engine oil, acetone or any other volatile liquid in the maintenance of the vehicle. These are toxic and highly flammable. They could lead to fire or explosions!

### CAUTION

- Only use appropriate fluids. Do not confuse fluids as this can cause serious malfunctions or engine damage.
- Accessories and other components mounted in front of the air inlet reduce the cooling

**effect of the coolant. If the engine is running under great strain in high outside temperatures, it could overheat.**

### For the sake of the environment

Leaking fluids could pollute the environment. Collect any spilt fluids in suitable containers and dispose of them in accordance with legislation and with respect for the environment.

## Repairs and technical changes

**When performing repairs and technical modifications, SEAT's directives must be observed! »» **

Unauthorised modifications to the electronic components or software in the vehicle may cause malfunctions. Due to the way the electronic components are linked together in networks, other indirect systems may be affected by the faults. This may significantly affect the vehicle's performance, increase component wear and could mean that the vehicle registration documents are no longer valid.

Your SEAT Official Service cannot be held liable for any damage caused by technical modifications or repairs performed incorrectly.

The SEAT Official Service does not accept liability for damage resulting from technical modifications or repairs performed incorrect-

ly; neither is the SEAT warranty valid in these cases.

SEAT recommends you have any technical modifications or repairs performed at a SEAT Official Service and that you use **genuine SEAT spare parts**<sup>®</sup>.

### Vehicles with special accessories and equipment

The manufacturers of additional equipment guarantee that the equipment complies with applicable laws and regulations with respect to the environment, in particular Directives 2000/53/CE and 2003/11/CE. The first directive governs the disposal of end-of-life vehicles while the second refers to the restrictions on the marketing and use of certain dangerous substances and preparations.

The vehicle owner should keep the documentation for the additional equipment safely and hand it over to the scrap yard at the end of the vehicle's service life. This ensures that any additional equipment mounted in end-of-life vehicles is correctly disposed of with respect for the environment.

### WARNING

**Repairs or modifications which are not performed correctly may result in damage or errors in the vehicle operation, affecting the effectiveness of the driver assist systems. This could result in serious accident.** »»

- **All repairs and modifications to the vehicle should only be performed by a specialised workshop.**

## Repair and faults in the airbag system

**When performing repairs and technical modifications, SEAT's directives must be observed! »» ⚠**

Modifications and repairs to the front bumper, doors, front seats, and repairs to the roof or chassis should only be carried out in a specialised workshop. These components may contain parts or sensors belonging to the airbag system.

If work is carried out on the airbag system or parts have to be removed and fitted on the system when performing other repair work, parts of the airbag system may be damaged. The consequence may be that, in the event of an accident, the airbag inflates incorrectly or does not inflate at all.

So that the effectiveness of the airbag is not reduced and that removed parts do not cause any injuries or environmental pollution, regulations must be observed. These requirements are known to specialised workshops.

Modifications to the vehicle suspension may affect the operation of the airbag system in the event of collision. For example, if wheel and tyre combinations not approved by SEAT

are used, or if the vehicle height is lowered, the suspension is stiffened or the suspension springs, telescopic arms, dampers, etc., are modified, the results received by the airbag sensors and sent to the control unit may not be accurate. For example, some modifications to the suspension could increase the force measured by the sensors and result in the triggering of the airbag systems in collisions. Under normal conditions, the measured values would be lower and the airbag would not have been triggered. Other modifications may reduce the forces measured by the sensors and prevent the airbags from being triggered when they should.

### ⚠ WARNING

**Repairs or modifications which are not performed correctly may result in damage or errors in the vehicle operation, affecting the effectiveness of the airbag systems. This could result in serious or fatal accidents.**

- **All repairs and modifications to the vehicle should only be performed by a specialised workshop.**
- **Airbag modules must never be repaired: if damaged, they must be replaced.**
- **Never fit recycled or reused airbag components in your vehicle.**

### ⚠ WARNING

**Modifications to the vehicle suspension, including the use of unauthorised wheel and**

**tyre combinations, may affect the performance of the airbags and increase the risk of serious or fatal injury in the event of accident.**

- **Never fit suspension components which are not identical to the original parts in the vehicle.**
- **Never use wheel and tyre combinations not approved by SEAT.**

## Retro-fitting of two-way radios

An exterior aerial is required for the use of two-way radios in the vehicle.

The retro-fitting of electrical or electronic appliances in the vehicle is subject to their approval for use in your vehicle. Under certain circumstances, this could mean that your vehicle registration documents are no longer valid.

SEAT has approved your vehicle for use with two-way radios providing the following conditions are observed:

- The exterior aerial must be mounted professionally.
- The maximum transmitting power is 10 watts.

The optimal reach of the equipment is only achieved with an external aerial.

Check first with a specialised workshop that understands the technical possibilities of installation if you wish to use a two-way radio with a transmitting power of over 10 watts. SEAT recommends taking your car in for technical service.

All legal requirements, together with the instructions for the use of two-way radios must be observed.

#### WARNING

**If the two-way radio is not securely fastened in position, it could be sent flying around the vehicle in the event of sharp braking, sudden manoeuvres or accident, causing injury.**

- While driving, two-way radios must be securely fastened in position, outside the airbags deployment zones, or safely stowed away.

#### WARNING

**When using a two-way radio without a connection to an exterior aerial, the maximum permitted levels of electromagnetic radiation may be exceeded. This is also the case if the aerial has not been correctly installed.**

- You should only use a two-way radio inside the vehicle if it has first been correctly connected to an exterior aerial.

## Information stored by the control units

Your vehicle is fitted at the factory with a series of electronic control units responsible for the engine and gearbox management. In addition, the control units supervise the performance of the exhaust gas system and the airbag systems.

Therefore, while the vehicle is being driven, these electronic control units are continuously analysing the vehicle data. In the event of faults or deviations from the theoretical values, only this data is stored. Normally, the warning lamps on the instrument panel light up in the event of faults.

This data can only be read and analysed using special equipment.

The storing of the data allows specialised workshops to detect and repair faults. Stored data may include:

- Data relating to the engine or the gearbox
- Speed
- Direction of travel
- Braking force
- Detection of seat belt

The vehicle control units never record conversations held by passengers in the vehicle.

In vehicles equipped with an emergency call function via the mobile phone or other appli-

ances connected in the vehicle, it is possible to send the vehicle position. If the control unit records an accident with airbag activation, the system may automatically send a signal. This will depend on the network operator. Normally, transmission is only possible in areas with good coverage.

## Event Data Recorder

The vehicle is **not** fitted with an event data recorder.

An event data recorder temporarily stores the vehicle information. Therefore, in the event of an accident, it is possible to obtain detailed information about how the accident occurred. Vehicles with airbag systems can store data relating to impact speed, seat belt status, seat positions and airbag activation times may be stored, etc. The volume of data depends on the manufacturer.

Event data recorders can only be mounted with authorisation from the vehicle owner and, in some countries, they are governed by local legislation.

## Reprogramming control units

On the whole, all the data required for the component management is stored in the control units. The programming of certain convenience functions, such as the turn signals, individual door opening and instructions on the display can be modified using special



equipment at the workshop. If the comfort functions are reprogrammed, the information and Instruction Manual descriptions will not coincide with the modified functions. Therefore, SEAT recommends that any modifications be recorded in the section "Other workshop notes" in the Maintenance Programme.

The SEAT Official Service must have a record of any modification to the programming.

### Reading the vehicle fault memory

There is a diagnostics connector in the vehicle interior for reading the vehicle fault memory. The fault memory documents errors and deviations from the theoretical values of the electronic control units.

The diagnostics connector is in the driver side footwell area, next to the lever for opening the bonnet, below a cover.

The fault memory should only be read and reset by a specialised workshop.

### Using a mobile telephone in a vehicle without connection to an exterior aerial

Mobile telephones transmit and receive radio waves also called high-frequency energy, both when in use and when on stand-by. Scientific studies state that radio waves exceeding certain values may be harmful to the hu-

man body. International committees and authorities have established limits and directives in order to ensure electromagnetic radiation from mobile phones remains within certain limits that do not endanger health. Nevertheless, there is no conclusive scientific evidence that wireless telephones are totally safe.

That is why some experts recommend moderate use of the mobile telephone, and the appliance of measures to reduce radiation on the human body.

When a mobile phone not connected to an exterior aerial is used inside the vehicle, the electromagnetic radiation may be greater than if the mobile phone were connected to a built-in aerial or to another exterior aerial.

If the vehicle is fitted with a suitable hands-free device that allows the employment of numerous additional mobile telephone functions with compatible Bluetooth technology®, it will comply with the legislation in many countries which only permits the use of mobile phones inside vehicles using a hands-free device.

The hands-free system of the Portable Navigation System (supplied by SEAT) has been designed for use with conventional mobile phones and phones with Bluetooth technology® **» page 123**. Mobile telephones must be placed in a suitable telephone support or stored safely in the vehicle. If a support is

used for the telephone, it must be securely fastened to the base plate. The mobile will be secure on the instrument panel and always within reach of the driver only by following these procedures. Mobile telephone connection with an external aerial is carried out subject to the hands-free device, via the telephone support or by the Bluetooth® connections present in the mobile telephone and the vehicle.

If the mobile phone is connected to an aerial incorporated into the vehicle or an exterior aerial connected to the vehicle, it will help reduce the electromagnetic radiation transmitted and the risk to human health. It will also improve the quality of the connection.

If the phone is used inside the vehicle without the hands-free system, it will not be securely fastened and will not be connected to the exterior aerial of the vehicle telephone. Nor will the telephone charge if it is not on the support. In addition, some calls may break off and the quality of the connection will be affected.

Mobile telephones should only be used inside the vehicle if they are connected to a hands-free system. SEAT recommends using an external aerial should you wish to use a mobile telephone inside the vehicle.

Bluetooth® is a registered trademark of Bluetooth® SIG, Inc.

**⚠ WARNING**

If the mobile phone is not securely fastened in position, it could be sent flying around the vehicle in the event of sharp braking, sudden manoeuvres or accident, causing injury.

- While driving, the mobile telephone, other equipment including telephone accessories such as telephone supports, notepads and navigators must be correctly secured, away from the airbags deployment zones, or stored in a safe place.

**⚠ WARNING**

When using a mobile telephone or two-way radio without connecting an external aerial, the maximum permitted levels of electromagnetic radiation in the vehicle may be exceeded, thus putting the driver and the rest of the vehicle occupants in danger. This is also the case if the aerial has not been correctly installed.

- A minimum of 20 centimetres should be kept between mobile phone aerials and artificial pacemakers, as mobile telephones may affect the working of pacemakers.
- Do not keep mobile phones in breast pockets directly above pacemakers.
- Immediately switch off the mobile telephone if you suspect any interference with pacemakers or other types of medical equipment.

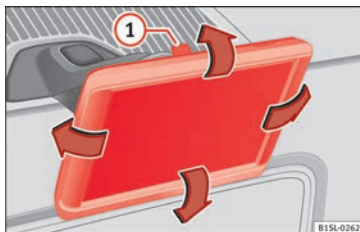
**SEAT Portable System\***

**Fig. 94** In the centre console: Remove the navigator.

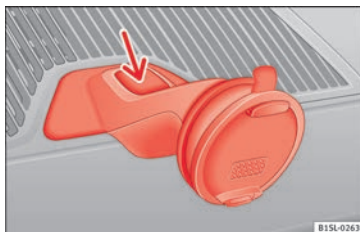

**Fig. 95** Remove the navigator holder

The SEAT Portable System (supplied by SEAT) allows for the use of other vehicle functions such as additional applications » » ⚠.

The gradient and the angle of vision can be set by moving the navigator to the required position » » **Fig. 94** » » ⚠.

The Portable Navigation System Instruction Manual can be observed directly on the equipment.

**Functions<sup>1)</sup>**

- Multifunction display (MFI) shown with additional instruments » » page 36.
- Operation of a factory-fitted radio and a » » **Booklet Radio system** connected multimedia player.
- Image display.
- Navigation.
- Hands-free system for mobile telephones via Bluetooth.
- Door open.
- Optical parking system (OPS).
- Recommended gear and driving advice.

**Observe the Instruction Manual in the equipment**

- Connect the Portable Navigation System.
- Press the button **more** on the screen.
- Press the **Manual** button.

<sup>1)</sup> subject to the vehicle

- Select the required chapter and press the corresponding button.

### Removing and fitting the navigator

- Securely support the navigator.
- Press the release button  until the device is released from its holder.
- Take the navigator out and store it safely.

To fit the navigator, place it in the upper support and push the lower part inside the holder until it engages with a click .

### Removing and fitting the navigator holder

- Press the holder release button  **Fig. 95** (arrow).
- Remove the holder from the dash panel in an upwards direction.
- If necessary, close the opening with the corresponding cover.

In order to fit the holder, place it on the opening from above and press in a downwards direction until it engages with a click. .

#### WARNING

Any distraction may lead to an accident, with the risk of injury. Operating the navigator could distract you from the traffic.

- Always stay alert and drive responsibly.

- Select volume settings that allow you to easily hear signals from outside the vehicle at all times (e.g. emergency service sirens).
- Setting the volume too high may cause damage to your hearing. This also applies if the device is set to high volumes for a short period.

#### WARNING

Journey instructions and traffic signals shown on the navigation system may differ to the current traffic situation.

- Traffic signals and driving regulations take precedence over journey instructions and indications from the navigation system.
- Adjust your speed and driving style to visibility, road, traffic and weather conditions.

#### WARNING

If the navigator is not securely fastened in position, it could be sent flying around the vehicle in the event of sharp braking, sudden manoeuvres or accident, causing injury.

- Fit the navigator housing safely on the corresponding opening on the dash panel.
- Always place the navigator securely in its holder or store it in the vehicle.

#### CAUTION

An unsuitable gradient and angle of vision setting can damage the navigator.

- When adjusting the navigation device, move it with care and not beyond its limits.

#### CAUTION

Excessively high or low outside temperatures can affect the Portable Navigation System operation or damage the device.

- Always take the Portable Navigation System with you when you leave the vehicle to protect it from excessively high or low temperatures and intense sunlight.

#### CAUTION

Humidity can damage the Portable Navigation System connections on the dash panel.

- Do not clean the holder for the navigation device with moist products. Use a dry cloth.

#### Note

SEAT recommends taking the Portable Navigation System with you when you leave the vehicle to prevent it from being stolen.

## Jacking points for raising vehicle

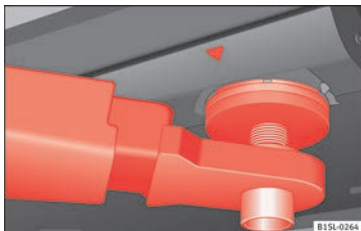

**Fig. 96** Front jacking points for raising vehicle with lifting platform or jack

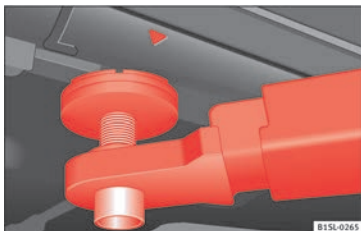

**Fig. 97** Rear jacking points for raising vehicle with lifting platform or jack

Always use the jacking points indicated in the figures » **Fig. 96** and » **Fig. 97** when raising the vehicle. If the vehicle is not lifted at these points, it could be seriously damaged » **!** or lead to serious injury » **△**.

The vehicle should not be lifted using lifting platforms with lift pads containing fluid.

When raising a vehicle using a platform or jack, a series of precautionary measures are required. Do not raise the vehicle with a lifting platform or jack unless you have received training in how to do so and know how to do so safely.

Notes on raising the vehicle with a jack » page 174.

### **△ WARNING**

The improper use of the lifting platform or the jack when raising the vehicle may result in accidents or serious injury.

- Before raising the vehicle, please observe the manufacturer's instructions for the platform or jack, and the legal requirements, where applicable.
- There should not be anyone inside the vehicle when it is being raised or once it is in the air.
- Only use the jacking points indicated in the figures » **Fig. 96** and » **Fig. 97** when raising the vehicle. If the vehicle is not lifted at the indicated points, it may fall from the platform while the engine or gearbox is being dismantled, for example.
- The jacking points should be centrally aligned and firmly positioned on the platform support plates.

- **Never start the engine when the vehicle is raised! The vehicle may fall from the platform due to the engine vibrations.**
- **If it is necessary to work underneath the vehicle while it is raised, you should check that the supporting stands have an adequate load capacity.**
- **Never climb onto the lifting platform.**
- **Always make sure that the weight of the vehicle does not exceed the lifting platform load capacity.**

### **! CAUTION**

- **Never raise the vehicle at the engine oil sump, the gearbox or the rear or front axles.**
- **Always use an intermediate rubber support to prevent damage to the vehicle underbody. Check that the arms of the lifting platform are able to move with obstruction.**
- **The arms should not come into contact with the side running boards or other parts of the vehicle.**

## Care and cleaning the vehicle exterior

### Introduction

Regular maintenance and washing help to **maintain the value** of the vehicle. This may »

also be one of the requirements for acknowledging warranty claims in the event of bodywork corrosion or paint defects.

Products suitable for the care of your vehicle are available at any technical service.

#### WARNING

Car-care products may be toxic and hazardous. If car care products are not suitable or are used inappropriately, this could result in accident, serious injury, burns or intoxication.

- Car care products must always be stored in the original container which should be kept closed.
- Observe information provided by the manufacturer.
- To prevent confusion, never store car care products in empty food cans, bottles or other containers.
- Keep all care products out of reach of children.
- Harmful vapours may be produced when using car care products. Therefore, care products should only be used in well-ventilated spaces or in the open air.
- Never use fuel, turpentine, engine oil, acetone or any other volatile liquid to wash, clean or care for the vehicle. These are toxic and highly flammable.

#### WARNING

Inappropriate care and cleaning of vehicle components may effect the vehicle safety equipment, increasing the risk of severe injury.

- Vehicle components should only be cleaned and maintained in accordance with the manufacturer's instructions.
- Only use approved or recommended care products.

#### CAUTION

Cleaning products which contain solvents will damage the material.

#### For the sake of the environment

Only wash the vehicle in areas allocated for this purpose, to prevent dirty water which may be contaminated by oil, grease or fuel, from entering the drains. In some places, even washing it outside the planned areas is banned.

#### For the sake of the environment

Where possible, always use products which respect the environment.

#### For the sake of the environment

The remains of car care products should not be disposed of with ordinary household

waste. Observe information provided by the manufacturer.

### Washing the vehicle

The longer substances such as insects, bird droppings, resinous tree sap, road dirt, industrial deposits, tar, soot or road salt and other aggressive materials remain on the vehicle, the more damage they do to the paintwork. High temperatures (for instance due to strong sunlight) further intensify the corrosive effect. The vehicle **undercarriage** should also be thoroughly washed at regular intervals.

#### Automatic car washes

**Always observe the instructions provided at the automatic car wash.** The standard precautionary measures prior to entering the car wash should be taken to avoid damage to the vehicle (close all windows, fold in exterior mirrors). If the vehicle is fitted with additional components (spoiler, roof-rack, aerial, etc.), check with the car wash supervisor whether these can enter the car wash » .

The vehicle paintwork is so durable that the vehicle can normally be washed without problems in an automatic car wash tunnel. However, wear and damage to the paintwork will depend on the type of car wash used.

SEAT recommends the use of car washes without brushes.

To remove traces of wax on windows and to prevent wiper blades from scratching, please observe the following » page 128, Cleaning windows and exterior mirrors.

### Washing the car by hand

When washing the car by hand, use plenty of water to soften the dirt first, and rinse off as well as possible.

Then clean the vehicle with a soft **sponge**, **glove** or **brush** using only slight pressure. Start at the roof and work downwards. Special **car shampoo** should only be used for very persistent dirt.

Rinse the sponge or glove thoroughly and often.

Wheels, sills and similar should be cleaned last. Use a second sponge for this.

#### WARNING

Sharp components on the vehicle may cause injury.

- Protect arms and hands from sharp edges when cleaning the vehicle undercarriage or the interior of the wheel hubs.

#### WARNING

After the vehicle has been washed, the braking effect will be reduced (and the braking distance increased) due to moisture (and ice in winter) on the brakes.

- “Dry the brakes and remove ice” by braking carefully. Ensure that you are not endangering other road-users or breaking traffic regulations in the process.

#### CAUTION

- The temperature of the water must not exceed +60 °C (+140 °F).
- To avoid damage to the paintwork, do not wash the vehicle in full sun.
- Do not use rough sponges or similar which could damage the surface to clean away the traces of insects.
- Never wipe the headlights with a dry cloth or sponge, always moisten first. It is best to use soapy water.
- Washing the vehicle in low temperatures: When washing the vehicle with a hose, do not direct water into the lock cylinders or the gaps around the doors or roof. Locks and seals could freeze!

#### CAUTION

To prevent damage to the vehicle, please observe the following before entering an automatic car wash:

- Compare the distance between the vehicle wheels and the distance between the guide-rails of the car wash to prevent damage to the wheels and tyres!
- Switch off the rain sensor before taking the vehicle to an automatic car wash.
- Compare the height and width of your vehicle with the available height and width when entering and driving through the car wash.
- Fold in exterior mirrors. Electrically retractable exterior mirrors must not be folded in or out by hand. Always use the electrical power control.
- To avoid damaging the bonnet paintwork, rest the windscreen wipers on the windscreen after drying the wiper blades. Do not let them fall!
- Lock the rear lid to prevent it from opening unexpectedly while inside the car wash.

### Washing the vehicle with high pressure cleaning apparatus

When cleaning the vehicle with a high-pressure cleaner, always follow the operating instructions for the equipment. Pay special attention to the required **pressure** of the jet and the **distance** between the jet and the vehicle » .

Keep a suitable distance from soft materials, such as rubber hoses or insulating material, »

and from the parking distance warning system sensors. The sensors of the parking distance warning system are situated on the rear bumper »»» ⓘ.

Do not use a nozzle that sprays the water out in a **direct stream** or one that has a **rotating jet** for forcing off dirt »»» ⚠.

#### ⚠ WARNING

The incorrect use of high pressure cleaning equipment could result in permanent damage, visible or invisible, to the tyres or other materials. This could result in a serious accident.

- Ensure there is a suitable distance between the nozzle and the tyres.
- Never wash tyres with a concentrated jet or so-called “dirt blasters”. Even at large spraying distances and short cleaning times, you may damage the tyres.

#### ⚠ WARNING

After the vehicle has been washed, the braking effect will be reduced (and the braking distance increased) due to moisture (and ice in winter) on the brakes.

- “Dry the brakes and remove ice” by braking carefully. Ensure that you are not endangering other road-users or breaking traffic regulations in the process.

#### ⓘ CAUTION

- The temperature of the water must not be above +60 °C (+140 °F).
- To avoid damage to the paintwork, do not wash the vehicle in full sun.
- To ensure that the system functions well, the sensors located on the bumper must be kept clean and free from ice. When cleaning with pressure hoses and steam cleaners, the sensors should be sprayed only briefly. A distance of 10 cm between the sensors and the steam / hose nozzle must be observed.
- Do not use a high pressure cleaner to remove ice or snow from windows
- Washing the vehicle in low temperatures: When washing the vehicle with a hose, do not direct water into the lock cylinders or the gaps around the doors or roof. Locks and seals could freeze!

### Cleaning windows and exterior mirrors

#### Cleaning windows and exterior mirrors

Spray windows and exterior windows with a standard window cleaner containing alcohol.

Dry the windows with a clean chamois leather or a lint-free cloth. The chamois leathers used on painted surfaces are not suitable for cleaning windows because they are soiled

with wax deposits which could smear the windows.

Use window cleaner or a silicone remover to clean rubber, oil, grease and silicone deposits off »»» ⓘ.

#### Removing wax deposits

Automatic car washes and certain car care products may leave **wax deposits** on the windows. These deposits can only be removed with a special product or cleaning cloths. If wax deposits are left on the windscreen and the rear window, the blades can scratch the glass. SEAT recommends you wipe the wax deposits off the windscreen and the rear window with a soft cloth each time after you have washed the vehicle.

A window cleaning detergent which helps to dissolve the wax may be added to the windscreen washer fluid to prevent the wiper blades from scratching the windscreen. Please ensure you add the cleaning product in the correct proportions. Products for removing grease do not eliminate the wax deposits »»» ⓘ.

Special cleaning products or window cloths are available at any technical service. To remove wax deposits, SEAT recommends the following products:

- For the hottest time of the year: the window cleaner for summer use G 052 184 A1. Proportion 1:100 (1 part detergent, 100 parts water) in the windscreen washer reservoir.
- All year round: the window cleaner G 052 164 A2; proportion 1:2 in windscreen washer bottle (1 part concentrate, 2 parts water) in winter, up to -18 °C (-0.4 °F), or 1:4, during the rest of the year.
- Window cloths G 052 522 A1 for all windows and exterior mirrors.

### Removing snow

Use a small brush to remove snow from the windows and exterior mirrors.

### Removing ice

If possible, use a de-icing spray to remove ice. If you use an ice scraper, push it in one direction only **without** swinging it. If you pull the scraper backwards, the dirt may scratch the window.

#### WARNING

**Dirty or misted windows reduce visibility in all directions and increase the risk of accident and serious injury.**

- Do not drive unless you have good visibility through all windows!
- Remove ice and snow from the windows and demist inside and out.

#### CAUTION

- **Never mix our cleaning products with other products not recommended by SEAT in the windscreen washer reservoir. This could lead to flocculation and may block the windscreen washer jets.**
- **Do not use hot or warm water to remove ice or snow from the windows and exterior mirrors. The glass could crack!**
- **The heating element for the rear window is located on the inner side of the window. Do not stick adhesive labels over the heating elements and never clean the inside of the rear window with corrosive or acid products or other similar chemical cleaning products.**

### Caring for and polishing the vehicle paintwork

#### Waxing

Regular waxing protects the paintwork. It is time to apply a good coat of *wax* when water no longer **forms droplets** and rolls off the **clean** paintwork.

Even if a **wax solution** is used regularly in the automatic car wash, SEAT recommends protecting the paint with a hard wax coating at least twice a year.

#### Polishing

Polishing is only necessary if the paint has lost its shine, and the gloss cannot be brought back by applying wax.

If the polish does not contain wax, a wax product should be applied after polishing.

#### CAUTION

- **To prevent damage, car polish or hard wax should not be used on components painted in matt paint, plastic components and the glass headlamp and tail light covers.**
- **Do not polish your vehicle in a sandy or dusty environment.**

### Care and cleaning of chrome and aluminium wheel rims

- Use a clean, damp, lint-free, smooth cloth to clean anodized surfaces.
- If there is a lot of dirt, use a special cleaning product which does not contain **solvents**.
- Then, polish the chrome and aluminium wheel trims with a smooth dry cloth.

#### CAUTION

**In order to prevent damage to the aluminium and chrome wheel trims:**

- **Do not clean or polish them in direct sunlight.**

- Do not clean or polish them in sandy or dusty environments.
- Do not use abrasive cleaning agents such as home cream cleaners.
- Do not use insect sponges, scouring pads, or similar products to clean insect deposits.
- Do not polish dirty surfaces.
- Do not use products containing solvents.
- Do not use hard wax.

#### ⓘ CAUTION

Chrome hub caps or wheel covers may have been painted additionally. Do not treat them with aluminium or chrome wax products, nor chrome or aluminium polish. Instead, use commercial paint wax or polish.

## Cleaning wheels

### Cleaning steel wheels

Use an industrial cleaner to remove brake dust. Therefore, clean wheels regularly with a separate sponge.

Any damage to the paint on steel wheels should be touched up before the metal starts to rust.

### Caring for and cleaning alloy wheels

Remove road salt and brake dust by washing the wheels approximately **once a fortnight**.

Use an acid free detergent to clean the wheel rims. SEAT recommends treating the wheel rims thoroughly with a **hard wax** about once every three months.

It is important to remove road salt and brake dust by washing the wheels at regular intervals, otherwise the finish will be impaired.

Always use an acid-free detergent for alloy wheel rims. Car polish or other abrasive agents should not be used for maintaining the rims.

If the protective coating on the paint has been damaged (for example, hit by a stone), it should be repaired immediately.

## Caring for rubber seals

The rubber seals on doors, windows, etc., remain flexible, provide a better seal and last longer if they are regularly treated with a product specifically designed for use on rubber.

Before applying the product, use a soft cloth to remove dust and dirt from the rubber seals.

## De-icing the door lock cylinder

To de-ice the lock cylinders, SEAT recommend the use of genuine SEAT spray with lubricating and anti-corrosive properties.

#### ⓘ CAUTION

The use of products containing degreasing agents to de-ice the locks may rust the lock cylinder.

## Protection of vehicle undercarriage

The vehicle underbody is coated to protect it from chemical and mechanical damage. The protective coat on the undercarriage may wear from use while driving. Therefore, SEAT recommends that the protective coating on the undercarriage and on the running gear should be regularly checked, and repaired if necessary.

#### ⚠ WARNING

Additional underseal or anti-corrosion products could catch fire due to the high temperatures reached by the exhaust gas system and other engine components.

- Do not apply additional underseal or anti-corrosion products to the exhaust pipes, catalytic converters, heat shields or other parts of the vehicle which reach high temperatures.

## Cleaning the engine compartment

The engine compartment of any motor vehicle is a potentially hazardous area »» page 143.

The engine compartment should only be cleaned by qualified personnel. If it is not correctly cleaned, the anti-corrosion coating and consequently electrical components may be damaged. Moreover, water may filter directly into the vehicle interior through the water chamber »» ❶.

If the engine compartment is very dirty, always take the vehicle to a specialised workshop for professional cleaning. SEAT recommends taking your car in for technical service.

### Water box

The water box is in the engine compartment, between the windscreen and the engine, and beneath a perforated cover. Air is taken in through the water box from outside to the vehicle interior via the heating and air conditioner.

Leaves and other loose objects should be regularly cleaned away from the water box either by hand or with a vacuum.

### ⚠ WARNING

**When working on the engine or in the engine compartment, there is a risk of injury, burns, accident or fire.**

- Before starting work, please ensure you are familiar with the required procedure and the safety precautions »» page 143.
- SEAT recommends getting a specialised workshop to do these jobs.

### ⚠ CAUTION

**If water is manually poured into the water box (e.g. using a high pressure cleaning appliance), this could cause significant damage to the vehicle.**

### ♻ For the sake of the environment

**Only wash the engine compartment in areas allocated for this purpose, to prevent dirty water which may be contaminated by oil, grease or fuel, from entering the drains. In some places, even washing this compartment outside planned areas for this purpose is banned.**

## Caring for and cleaning the vehicle interior

### Introduction

The dye from many items of modern clothing (e.g. dark jeans) is not always colour-fast. Seat upholstery (material and leather), especially when light-coloured, may visibly discolour if the dye comes out of clothing (even when used correctly). This is not an upholstery defect but indicates that the dye in the item of clothing is not sufficiently colour-fast.

### ⚠ WARNING

**Car-care products may be toxic and hazardous. If car care products are not suitable or are used inappropriately, this could result in accident, serious injury, burns or intoxication.**

- Car care products must always be stored in the original container which should be kept closed.
- Observe information provided by the manufacturer.
- To prevent confusion, never store car care products in empty food cans, bottles or other containers.
- Keep all care products out of reach of children.

»

- Harmful vapours may be produced when using car care products. Therefore, care products should only be used in well-ventilated spaces or in the open air.

- Never use fuel, turpentine, engine oil, acetone or any other volatile liquid to wash, clean or care for the vehicle. These are toxic and highly flammable.

#### WARNING

Inappropriate care and cleaning of vehicle components may effect the vehicle safety equipment, increasing the risk of severe injury.

- Vehicle components should only be cleaned and maintained in accordance with the manufacturer's instructions.
- Only use approved or recommended care products.



#### CAUTION

- Cleaning products which contain solvents will damage the material.
- To avoid damage, stubborn stains should be removed by a specialised workshop.

#### Note

Suitable vehicle care products are available from your technical service.

## Treating your upholstery

To treat and maintain your seat upholstery, keep the following in mind  

- Before entering the vehicle, close any Velcro fasteners that might snag on the upholstery or trim fabric. Any open Velcro fasteners may damage the trim or upholstery fabrics.
- To prevent damage, avoid direct contact between sharp decorative objects and the upholstery and trim fabrics. Decorative objects include zips, rivets and rhinestones on clothing and belts.
- From time to time, clean the dust that gathers in the perforations, folds and seams so that the surfaces of the seats are not damaged by its abrasive effect.
- Make sure clothes are colour-fast to avoid them running and staining the upholstery. This is especially important if the upholstery is light in colour.

#### CAUTION



If the instructions for upholstery and trim care are not followed, they may deteriorate and discolour.

#### Note

SEAT recommends you take the vehicle to a specialised workshop to treat any stains on the upholstery caused by the discolouration of clothing.

## Padding and fabric trim cleaning

### Normal cleaning

- Before applying cleaning products, please read the instructions for handling and the warnings shown on the container.
- The upholstery, textile covers, and carpet should be regularly vacuumed (with vacuum brush).
- We recommend that you use a soft sponge or lint-free, micro-fibre cloth for normal cleaning  .

General superficial dirt on upholstery and textile covers can be cleaned with a normal foam cleaning product.

If the upholstery and the material trims are very dirty, we recommend you have them cleaned by a specialist cleaning form.

### Cleaning stains

It may be necessary to clean the whole surface and not only the stain itself. Especially if the surface has been dirtied through normal use. Otherwise, the stained area may become lighter than the rest of the surface after treatment.

Type of stain	Cleaning the vehicle
<i>Water-based stains</i> , e.g. coffee or fruit juice.	<ul style="list-style-type: none"> <li>– Use a sponge and wipe with a solution of water and wool wash.</li> <li>– Dry with a dry, absorbent cloth.</li> </ul>
<i>Persistent stains</i> , e.g. chocolate or make-up.	<ul style="list-style-type: none"> <li>– Apply a washing paste<sup>a)</sup> directly to the stain and allow it to work.</li> <li>– Apply clean water using a sponge or damp cloth to remove the cleaning product deposits.</li> <li>– Dry with a dry absorbent cloth.</li> </ul>
<i>Grease-based stains</i> , e.g. oil or lipstick.	<ul style="list-style-type: none"> <li>– Apply neutral soap or cleaning paste<sup>a)</sup> and allow it to work.</li> <li>– Remove dissolved grease or colour particles with an absorbent cloth.</li> <li>– Then apply clean water. Take care not to soak the upholstery.</li> </ul>

<sup>a)</sup> Bile soap can be used as a cleaning paste.

### ⓘ CAUTION

- **Brushes should only be used to clean the mats and floor mat! Other surfaces may be damaged if a brush is used.**
- **Do not use steam cleaning equipment, as the dirt becomes more encrusted in the material when steam is applied.**
- **Never use brushes for cleaning damp material as they could damage the surface.**

## Cleaning storage compartments, drinks holders and ashtray



**Fig. 98** In the front part of the centre console: Storage compartment with cup holder.



**Fig. 99** Ashtray removed and open with area to stub cigarettes

## Cleaning storage compartments and drinks holders

- Use a clean, damp, lint-free cloth to clean parts.
- If this does not provide satisfactory results, we recommend using a special **solvent-free** plastic cleaning product.

## Cleaning the ashtray

- Extract the ashtray and empty it.
- Clean the ashtray with a dishcloth.

Use a toothpick or similar to remove ash from the area where cigarettes are stubbed out

» **Fig. 99.**

## Care and cleaning of plastic parts, wooden trim and the instrument panel

- Use a clean, damp, lint-free cloth to clean parts.
- *Clean plastic parts (inside and outside the vehicle) and the dash panel with a special **solvent-free** product for the care and cleaning of plastic, approved by SEAT* »
- Wash *wooden trims* with a mild soap and water solution.
- *Clean the Portable Navigation System housing (Supplied by SEAT) with a dry cloth only.* »

**⚠ WARNING**

Solvents cause the surfaces of the airbag modules to become porous. If an airbag is accidentally triggered, the detachment of plastic parts could cause serious injury.

- Never clean the dash panel and the surfaces of the airbag modules with cleaners containing solvents.

**ⓘ CAUTION**

When cleaning the instrument panel, be careful not to dampen the Portable Navigation System connections as this can damage the electrical installation.

**Cleaning seat belts**

If the seat belt is very dirty, the belt retractor may not work correctly thus preventing the seat belt from operating correctly.

The seat belts should never be removed from the vehicle for cleaning.

- Use a soft brush to remove the worst dirt  
»» **⚠**.
- Pull the seat belt right out and leave it out.
- Clean dirty seat belts with a *gentle* soap and water solution.
- Wait until they are completely dry.
- Only allow the seat belt to retract when it is completely dry.

**⚠ WARNING**

Check the condition of all the seat belts at regular intervals. If the webbing or other parts of the seat belt are damaged, the vehicle should be taken to a Specialised workshop immediately and the belts should be replaced. It is extremely dangerous to drive using damaged seat belts and could result in serious injury or loss of life.

- Seat belts and their components must never be cleaned with chemical products, nor should they be allowed to come into contact with corrosive liquids, solvents or sharp objects. This could affect the strength of the seat belt webbing.
- Seat belts should be completely dry before retracting. Dampness could damage the belt retractor so that it does not operate correctly.
- Do not allow liquids or foreign bodies to enter the buckle fastenings. This could damage the buckles and seat belts.
- Never attempt to repair, modify or remove a seat belt yourself.
- Always have damaged seatbelts replaced immediately by seat belts approved for the vehicle in question by SEAT. Seat belts which have been worn in an accident and stretched must be replaced by a specialised workshop. Renewal may be necessary even if there is no apparent damage. The belt anchorage should also be checked.

**Notes for the user****Introduction****⚠ WARNING**

Failure to treat the vehicle with the correct care increases the risk of accident and injury.

- Observe legal requirements.
- Observe the Instruction Manual.

**ⓘ CAUTION**

If the vehicle is not properly cared for, damage may occur.

- Observe legal requirements.
- Carry out regular maintenance of the vehicle, according to specifications in the Maintenance Programme.
- Observe the Instruction Manual.

## Labels and plates

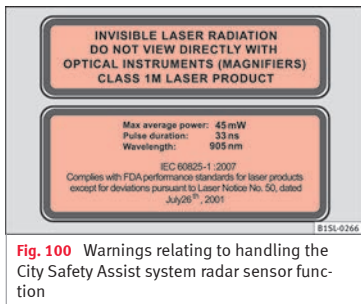

**Fig. 100** Warnings relating to handling the City Safety Assist system radar sensor function

Some parts in the engine compartment come from the factory with certificates of safety, labels or plates containing important information regarding the operation of the vehicle, for example, on the petrol cap, on the passenger's sun visor, on the driver door strut, or on the floor of the boot.

- Never remove these certificates of safety, labels or plates, and ensure they are kept in good condition and are legible.
- If a vehicle part, bearing a certificate of safety, label or plate, is replaced, the specialised workshop should attach the information back in the same place.

## Certificate of safety

A certificate of safety on the door strut states that all the safety standards and regulations established by the national traffic authorities responsible for road safety were met at the time of manufacture. It may also give the month and year of manufacture, together with the chassis number.

## Warning of high voltage label

There is a label close to the bonnet lock which warns of high voltage in the vehicle's electrical system.

## Warning relating to the City Safety Assist system laser sensor

There are some warning and information signs on the City Safety Assist system laser sensor » **Fig. 100**.

## Using your vehicle in other countries and continents

The vehicle is manufactured at the factory for use in a particular country in accordance with the national legislation in force at the time of manufacture.

If the vehicle is sold in another country or used in another country for an extended period of time, the applicable legislation of that country should be observed.

It may be necessary to fit or remove certain pieces of equipment or to deactivate certain functions. Service work may also be affected. This is particularly true if the vehicle is used in a different climate for an extended period of time.

As there are different types of frequency bands around the world, you may find that the radio system or the Portable Navigation System (supplied by SEAT) supplied at the factory does not work in another country.

### ⚠ CAUTION

- **SEAT does not accept liability for any damage to the vehicle due to the use of a lower quality fuel, an inadequate service or the non-availability of genuine spare parts.**
- **SEAT does not accept liability if the vehicle does not comply in part or in full with the legal requirements of other countries or continents.**

## Radio reception and the aerial

For factory-fitted radio equipment, the aerial for radio reception is fitted to the roof of the vehicle.

### **i** Note

**If electrical equipment such as mobile telephones, is used near a roof aerial, you may** »

**observe interference in the reception of AM stations.**

### Notes on SEAT repairs

Following payment, information about authorised SEAT services and authorised SEAT repairs in the following locations can be requested:

#### Clients in Europe, Asia, Australia, Africa, Central America and South America

Contact a technical service or specialised workshop, or request the corresponding documentation at [www.erwin.volkswagen.de](http://www.erwin.volkswagen.de).

#### WARNING

**Repairs or modifications which are not performed correctly may result in damage or errors in the vehicle operation, affecting the effectiveness of the driver assist and airbag systems. This could result in serious accident.**

- Have any repairs or modifications carried out at a specialised workshop.

### Conformity certification

The respective manufacturer hereby declares that the products indicated below comply with basic requirements and the following

provisions and important legislation on the date of manufacture of the vehicle, among others FCC Part 15.19, FCC Part 15.21 and RSS-Gen Issue 1:

#### Radio frequency equipment

- Electronic gearbox lock.
- Vehicle key

#### Electrical equipment

- 12 volt power socket

### Collection and scrapping of end-of-life vehicles

#### Collection of end-of-life vehicles

SEAT is already prepared for the moment when you wish to scrap your vehicle and offers you an environmentally-friendly solution. An extensive network of used car reception centres already exists in much of Europe. After the vehicle has been delivered, you will receive a certificate of destruction describing the environmentally friendly scrapping of the vehicle in accordance with applicable legislation.

We will collect the used vehicle free of charge, provided it complies with all national legislation.

Please see your technical service for further information about the collection and scrapping of end-of-life vehicles.

#### Scrapping

The relevant safety requirements must be observed when the vehicle or components of the airbag or belt tensioner systems are scrapped. These requirements are known to specialised workshops.

## Checking and refilling levels

### Fuel

#### Introduction

You will find a factory-fitted sticker containing information on the type of fuel for your vehicle on the inside of the fuel tank flap.

#### WARNING

**Refuelling or handling fuel carelessly can cause an explosion or fire resulting in serious burns and injuries.**

- Fuel is a highly explosive, easily flammable substance.
- Observe current safety instructions and local regulations concerning the handling of fuel.

#### Types of fuel

The type of fuel to use when refilling will depend on the vehicle's engine. You will find a factory-fitted sticker containing information on the type of fuel for your vehicle on the inside of the fuel tank flap.

SEAT recommends the use of sulphur-free or low sulphur fuel to reduce consumption and prevent engine damage.

Possible types of fuel	Alternative names	Further information
91 <sup>a)</sup> RON	Normal petrol, normal unleaded petrol	» page 137
95 <sup>a)</sup> RON	Premium unleaded petrol (95 RON)	
98 <sup>a)</sup> RON	Premium unleaded petrol (98 RON)	

<sup>a)</sup> RON = Regulation Octane Number

#### Petrol

##### Petrol types

Vehicles with petrol engines must refuel using unleaded petrol according to European norm EN 228 » .

Petrol types are categorised according to their octane number (e.g. 91, 95, 98 or 99 RON (RON = "Research Octane Number"). You may use petrol with a high octane number than the one recommended for your engine. However, this has no advantage in terms of fuel consumption and engine power.

SEAT recommends refuelling with a low sulphur content or sulphur-free petrol to reduce fuel consumption for petrol engines.

##### Petrol additives

The quality of the fuel influences the behaviour, power and service life of the engine. This is why the petrol you use should carry suitable additives already included by the petrol industry, free of metals. These additives will help to prevent corrosion, keep the fuel system clean and prevent deposits from building up in the engine.

If good-quality petrol with metal-free additives is not available or engine problems arise, the necessary additives must be added when refuelling » .

Not all petrol additives have been shown to be effective. The use of unsuitable petrol additives may cause significant damage to the engine and the catalytic converter. Metal additives should never be used. Metal additives may also be contained in petrol additives for improving anti-detonation ratings or octane ratings » .

SEAT recommends "genuine Volkswagen Group Fuel Additives for petrol engines". These additives can be bought at SEAT dealers, where information on how to use them can also be obtained.

#### CAUTION

- Do not refuel if the filler indicates that the fuel contains metal. LRP (lead replacement petrol) fuels contain high concentrations of »

**metal additives. Using them may damage the engine!**

- Only use fuel with an octane rating that is in line with the norm EN 228, otherwise significant damage could be caused to the engine and fuel system. Furthermore, it could lead to a loss of performance with the consequent engine fault.
- The use of unsuitable petrol additives could seriously damage the engine and the catalytic converter.
- If, in exceptional circumstances, petrol with a lower octane rating to that recommended is used, only use moderate engine speeds and a light throttle. Avoid using full throttle and overloading the engine. Otherwise engine damage may occur. Fill up with fuel of a suitable octane rating as soon as possible.
- Just filling one full tank of leaded fuel or with other metal additives would seriously impair the efficiency of the catalytic converter and could damage it.

## Natural gas

Natural gas, in addition to others, can be in liquid form.

Liquefied natural gas (LNG) is the result of heavy cooling of natural gas. Therefore its volume is considerably reduced compared with compressed natural gas (CNG). In vehicles with a natural gas engine, liquefied natural gas cannot be directly refilled, as the gas

would expand excessively in the vehicle gas tank.

Therefore, vehicles with a natural gas engine must only be refuelled using compressed natural gas »» » ⚠.

### Natural gas quality and consumption

Natural gas is divided into the groups H and L depending on its quality.

Gas type H has a superior heating power and inferior nitrogen and carbon dioxide content than type L. The higher the heating power of the natural gas, the lower the consumption will be.

However, the heating power and the proportion of nitrogen and carbon dioxide can fluctuate within the quality groups. Therefore, vehicle consumption can also vary when using one type of gas only.

The engine management automatically adapts to the natural gas used according to its quality. Therefore, different quality gases can be mixed in the tank, without the need for comprehensive draining before applying a different quality gas.

### Natural gas and safety

If you can smell gas or suspect that there is a leak »» » ⚠:

- Stop the vehicle immediately.

- Switch the ignition off.
- Open the doors to appropriately ventilate the vehicle.
- Immediately extinguish cigarettes.
- Move away from the vehicle or switch off objects that may cause sparks or a fire.
- If you continue to smell gas, do not continue driving!
- Seek specialist assistance. Have the fault repaired.

#### ⚠ WARNING

**Failure to act when you can smell gas in the vehicle or when refuelling can cause serious injuries.**

- Carry out the necessary operations.
- Leave the danger zone.
- If necessary, warn the emergency services.

#### ⚠ WARNING

**The vehicle is not prepared to use liquefied natural gas (LNG) and this fuel must not be added under any circumstances. Liquefied natural gas can cause the natural gas tank to explode, resulting in serious injury.**

#### Note

**The natural gas system must be subject to regular inspections at a specialised workshop in accordance with the Maintenance Programme.**

## Filling the tank

### Introduction

The fuel tank flap is on the rear right of the vehicle.

#### WARNING

Refuelling or handling fuel carelessly can cause an explosion or fire resulting in serious burns and injuries.

- Always make sure that you correctly close the fuel cap to avoid evaporation and fuel spillage.
- Fuels are highly explosive and inflammable substances that can cause serious burns and injuries.
- Fuel could leak out or be spilt if the engine is not switched off or if the filler fuel nozzle is not fully inserted into the tank filler neck when refuelling. This could lead to a fire, explosion and severe injuries.
- When refuelling, turn off the engine and turn off the ignition for safety reasons.
- Always turn off mobile telephones, radio apparatus and other radio wave emitting equipment before refuelling. Electromagnetic waves could cause sparks and lead to a fire.
- Never enter the vehicle while refuelling. If it is absolutely necessary to enter, close the door and touch a metal surface before touch-

ing the filler nozzle again. This will prevent the generation of static electricity. Sparks could cause a fire when refuelling.

- Never handle fuel close to flames, sparks or objects with slow combustion (e.g. cigarettes).
- Avoid static electricity and electro-magnetic radiation when refuelling.
- Observe the safety regulations of the service station.
- Never spill fuel on the vehicle or in the luggage compartment.

#### WARNING

For safety reasons, SEAT does not recommend carrying a spare fuel canister in the vehicle. Fuel could be spilled and catch fire, above all in case of an accident and this applies to a full container as well as empty containers. This could lead to explosions, fires and injuries.

- Observe the following if you exceptionally have to carry fuel in a canister:
  - Never place a fuel container, to fill it, inside the vehicle or on the vehicle, for example, in the luggage compartment. Filling in these circumstances could create an electrostatic charge and spark that could ignite fuel fumes.
  - Always place the canister on the ground to fill it.

- Insert the fuel nozzle into the neck of the canister as far as possible.
- If you are using a metal fuel canister, the nozzle must always touch the canister while it is being filled to avoid static electricity.
- Follow the legal requirements for the use, storage and transport of spare fuel canisters.
- Insure that the fuel container complies with manufacturing standards, for example, ANSI or ASTM F852-86.

#### CAUTION

- Always remove any fuel spilled anywhere on the vehicle to avoid damage to the wheel housing, the tyre and vehicle paintwork.
- Refuelling a petrol engine with diesel can cause serious engine and fuel system damage; the resulting malfunctions are not covered by the SEAT warranty. If you refuel with the wrong type of fuel, never start the engine. This applies to even the smallest amount of the wrong fuel. Seek specialist assistance. With the engine running, the composition of the wrong fuel could significantly damage the fuel system and the engine itself.

#### For the sake of the environment

Fuels can contaminate the environment. Collect any spilt service fluids and allow a professional to dispose of them.

## Control lamps and fuel gauge



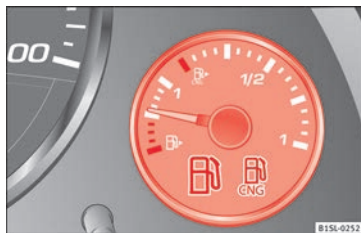

**Fig. 101** On the instrument panel: fuel gauge for petrol







**Fig. 102** On the instrument panel: Fuel gauge for petrol and natural gas.

The fuel gauge can vary depending on the vehicle equipment » » **Fig. 101** or » » **Fig. 102**.

It lights up	Gauge position » » <b>Fig. 101</b>	Possible cause » » ⚠	Solution
 <sup>a)</sup>	Red mark (arrow)	The fuel tank is almost empty. The reserve tank is being used » » page 203.	Refuel as soon as possible » » ⚠.
	–	The vehicle is running in natural gas operating mode.	–

<sup>a)</sup> This only applies to vehicles with the fuel gauge on the dash panel » » **Fig. 101**.

## Checking and refilling levels

Flashes for about 10 seconds	State of the bars	Possible cause » 	Solution
 and the segments remaining <sup>a)</sup>	Reserve zone (four small segments)	The fuel tank is almost empty. The reserve tank is being used » page 203.	Refuel as soon as possible »  .
	–	The vehicle is running in natural gas operating mode.	–

<sup>a)</sup> This only applies to vehicles with the fuel gauge on the dash panel display.

Several warning and control lamps light up for a few seconds when the ignition is switched on, signalling that the function is being verified. They will switch off after a few seconds.

### In natural gas engines

The warning lamp  lights up when both fuel types (petrol and natural gas) have reached reserve level.

The warning lamp  lights up when the vehicle is running in natural gas operating mode.

The warning lamp  switches off when the natural gas is exhausted. The engine changes to operate with petrol.

**Problem:** if the vehicle is left parked for a long time just after refuelling, the gas level indicator does not accurately indicate the same level shown after refuelling when the vehicle is started up again. This is not due to a leak in the system, but to a drop in pressure in the gas tank for technical reasons af-

ter a cooling phase immediately after refuelling.

### WARNING

**Driving with insufficient fuel reserve could result in the vehicle breaking down in traffic and a serious accident.**

- If the fuel level is too low then the fuel supply to the engine can become irregular especially on slopes.
- If the engine “is choked” or stalls due to lack of or irregularity of the fuel supply, the power steering as well as all of the driver assistance systems including braking assistance will stop working.
- Always refuel when there is only one quarter of the fuel tank left to avoid running out of fuel.

### CAUTION

- Always pay attention to any lit control lamps and to the corresponding descriptions

**and instructions to avoid damage to the vehicle.**

- Never run the fuel tank completely dry. An irregular fuel supply may lead to ignition faults and unburnt fuel could enter the exhaust system. This could damage the catalytic converter.

### Note

The arrow next to the fuel pump symbol on the instrument panel » **Fig. 101** indicates the side of the vehicle on which the tank flap is located.

## Refuelling with petrol

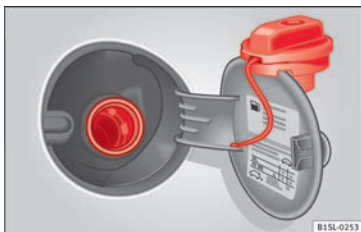

**Fig. 103** Open tank flap with tank cap attached to the holder

**Before** refuelling, always turn off the engine, the ignition, mobile telephones, auxiliary heating and keep them off during refuelling.

### Opening the fuel tank cap

- The tank flap is at the rear of the vehicle on the right.
- Pull the rear zone of the fuel tank flap to open.
- Unfold the key shaft if necessary  
»» page 43.
- Insert the vehicle key into the lock cylinder of the fuel tank plug and turn the key in an anticlockwise direction.
- Take out the fuel tank plug by turning it in an anticlockwise direction and rest it on the upper part of the fuel tank flap »» **Fig. 103**.

## Refuelling

The correct petrol type for the vehicle is located on a sticker inside the fuel tank flap  
»» page 137.

- If the automatic filler nozzle is operated correctly, it will switch itself off as soon as the fuel tank is **full** »» **△**.
- Do not continue to refuel if it is turned off! Otherwise, this will fill the expansion chamber and fuel may leak out if the ambient conditions are warm.

### Closing the fuel tank cap

- Screw on the fuel tank filler plug in a clockwise direction until it is fully inserted with a click.
- Insert the vehicle key into the lock cylinder of the fuel tank plug, turn the key in a clockwise direction and remove the key.
- Press the tank flap until you hear it click into place. The tank flap must be flush with the body contour.

### **△** WARNING

**Do not continue refilling once the fuel nozzle has switched itself off. The fuel tank may be filled too much. As a result, fuel may spurt out and spill. This could lead to a fire, explosion and severe injuries.**

### **ⓘ** CAUTION

• Always remove any fuel spilled anywhere on the vehicle to avoid damage to the wheel housing, the tyre and vehicle paintwork.

### **♻️** For the sake of the environment

Fuels can contaminate the environment. Collect any spilt service fluids and allow a professional to dispose of them.

## Refuelling with natural gas

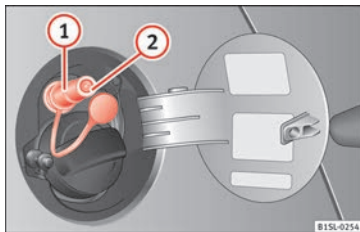

**Fig. 104** Tank flap open: gas filler mouth **①**, filler mouth retainer **②**

**Before** refuelling, the engine and the ignition, mobile telephone and heating must be switched off separately »» **△**.

It is also essential to carefully read the instructions for the natural gas pump.

The vehicle is only prepared for refuelling with Compressed Natural Gas (CNG) » » ⚠. Refuelling with another type of natural gas is not allowed, e.g. Liquefied Nature Gas (LNG) or hydromethane.

### Opening the fuel tank cap

The natural gas filler mouth is behind the fuel tank cap, next to the petrol filler mouth.

- Unlock the vehicle with the key or with the central locking button  situated on the driver door » » page 48.
- Press on the rear area of the flap and open it.

### Refuelling

**Problem:** If the ambient temperature is very high, the natural gas pump protection against overheating disconnects this automatically.

- Remove the plug from the gas filler mouth » » Fig. 104 ①.
- Connect the pump filling nozzle to the gas filler mouth.
- The fuel tank will be *full* when the pump compressor automatically cuts the supply.
- If you wish to finish refuelling in advance, press the button on the pump to stop the flow.

### Closing the fuel tank cap

- Check that the gas filler mouth retainer ② is not trapped with the filler nozzle. If necessary, place it in the filler mouth again.
- Insert the plug in the filler mouth.
- Close the tank flap. Make sure you hear it click into place.

#### WARNING

Natural gas is a highly explosive, easily flammable substance. Incorrect handling of the natural gas can cause accidents serious burns and other injuries.

- Before refuelling with natural gas, the filling mouth must be correctly engaged. If you can smell gas, stop refuelling immediately.

#### WARNING

The vehicle is not prepared to use liquefied natural gas (LNG) and this fuel must not be added under any circumstances. Liquefied natural gas can cause the natural gas tank to explode, resulting in serious injury.

#### Note

- The filling nozzles of natural gas pumps can differ in the way they are operated. If you are unacquainted with the pump, it is advisable that a member of staff of the service station performs the refuelling operation.

- Noises heard when refuelling are normal and do not indicate the presence of a fault in the system.
- The vehicle natural gas system is prepared both for refuelling with a small compressor (slow refuel) and a large compressor (fast refuel) in natural gas service stations.

## Bonnet

### Working in the engine compartment

Before working in the engine compartment, make sure that the vehicle is parked on horizontal and firm ground.

The engine compartment of the vehicle is a hazardous area. Never work on the engine or in the engine compartment if you are not familiar with the operations to be carried out, the applicable safety standards and especially if you do not have the necessary instruments, liquids and tools » » ⚠! If required, have any work carried out by a specialised workshop. Negligent work can cause serious injury.

#### WARNING

If the vehicle moves unexpectedly, this could cause serious injury. » »

- Never work under the vehicle if it has not been immobilized. If you must work underneath the vehicle with the wheels in contact with the ground then it should be parked on flat ground, the wheels should be prevented from moving and the key should be removed from the ignition.
- If you have to work underneath the vehicle, you must use suitable stands additionally to support the vehicle, there is a risk of accident!. The jack is not intended for this kind of work and its failure could lead to severe injuries.
- Disconnect the Start-Stop system.

#### WARNING

The engine compartment is a dangerous area capable of causing serious injury.

- For all type of work, always take the utmost precautions, work carefully and note the general safety standards in force. Never take personal risks.
- Never work on the engine or in the engine compartment if you are not familiar with the necessary operations. If you are not sure about procedures then visit a specialised workshop to carry out the necessary work. Working incorrectly can cause serious injuries.
- Never open the bonnet if you see steam or coolant escaping from the engine compartment. This may cause serious burns. Always wait until you cannot see or hear the sound of

steam or coolant coming from the engine compartment.

- Always allow the engine to cool down before opening the bonnet.
- Contact with hot elements of the engine and the exhaust system can cause burns.
- Once the engine has cooled, follow the instructions below before opening the bonnet:
  - Engage the handbrake and place the gear selector lever in N or the gear stick in neutral.
  - Remove the key from the ignition.
  - Keep children away from the engine compartment and never leave them unsupervised.
- When the engine is warm or hot, the cooling system is pressurised. Do not unscrew the cap on the expansion tank when the engine is hot. Otherwise, coolant may spray out under pressure causing burns and serious injury.
  - After cooling, carefully and slowly unscrew the cap anticlockwise, gently pressing down on it.
  - Always protect your face, hands and arms from hot coolant and steam using a large, thick cloth.
- When refilling liquids, avoid spilling them on parts of the engine and the exhaust system. Spilled liquids could cause a fire.

#### WARNING

The high voltages of the electrical system can give electric shocks as well as causing burns and serious injury and possibly even death!

- Never cause short circuits in the electrical system. The battery could explode.
- To minimise the risk of electric shock and serious consequences while the engine is running or starting the engine, note the following:
  - Never touch the electrical wiring of the ignition system.

#### WARNING

In the engine compartment, there are rotating parts that could cause serious injury.

- Never place your hands directly on or near the radiator fan. Touching the rotor blades could seriously harm you. The ventilator works according to the engine temperature and could start suddenly even when the ignition is turned off and the key is removed.
- If any work has to be performed when the engine is started or with the engine running, there is an additional, potentially fatal, safety risk from rotating parts, such as the drive belts, alternator, radiator fan, etc., as well as from the high-voltage ignition system. Always work with the utmost caution.
  - Always make sure that no parts of your body, jewellery, ties, loose clothing and long hair can be trapped by the rotating

parts of the engine. Before any work, remove ties and jewellery (necklaces, etc), tie long hair back and tie all items of loose clothing to your body to make sure that they cannot be trapped by engine components.

– Take extreme caution when operating the accelerator and remain attentive. The vehicle could move, even if the handbrake is applied.

• Always make sure you have not left any objects, such as cleaning cloths and tools, in the engine compartment. If any object is left in the engine compartment, this could cause malfunctions, engine faults and even a fire.

### **⚠ WARNING**

Refill liquids and certain materials can catch fire easily in the engine compartment, causing a fire and serious injury!

- Never smoke.
- Never work close to places exposed to flames or sparks.
- Never pour service fluids over the engine. These fluid may ignite hot engine parts and cause injuries.
- If it is necessary to work on the fuel system or the electrical system, please follow the instructions below:
  - Always disconnect the vehicle battery.
  - Never work close to heaters, heat sources or places exposed to flames or sparks.

- Always keep a recently serviced and perfectly working fire extinguisher close by.
- Never cover the engine with additional insulating materials such as a blanket. Risk of fire!

### **⚠ CAUTION**

When refilling or changing service liquids, ensure that you put the liquids into the right tank. Making a mistake when refilling could cause serious malfunctions and damage the engine!

### **♻ For the sake of the environment**

Service fluids leaks are harmful to the environment. For this reason you should make regular checks on the ground underneath your vehicle. Take the vehicle to a specialised workshop to be checked if you see stains, oil or other fluids on the ground. Collect any spilt service fluids and allow a professional to dispose of them.

## Opening and closing the bonnet

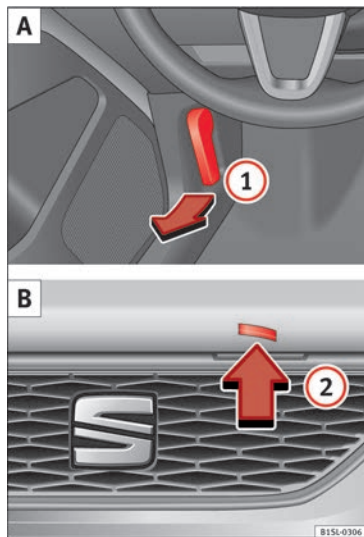

**Fig. 105** A: Release lever in the footwell on the driver side B: Release lever on the bonnet »

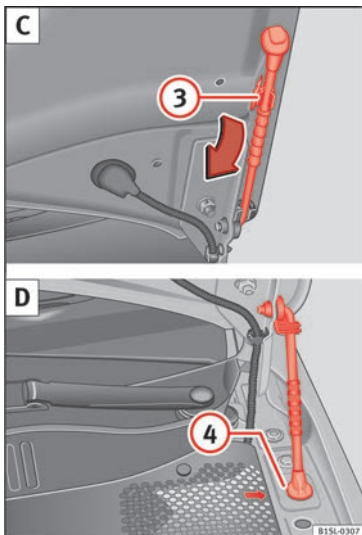

**Fig. 106** C: Bonnet securing rod in the bonnet. D: Bonnet supported by the bonnet securing rod

### Opening the bonnet

- Before opening the bonnet, make sure that the windscreen wiper arms are in place against the windscreen »»» ❶.
- Pull the release lever ❶ in the direction of the arrow »» Fig. 105 A. The bonnet is re-

leased from the lock carrier by a spring mechanism »»» ⚠.

- Lift the bonnet up slightly while pressing the release lever ❷ B in the direction of the arrow to completely open the bonnet.
- Take out the bonnet support rod from its clip in the direction of the arrow ❸ C and place it in the corresponding open position ❹ D (arrow).

### Closing the bonnet

- Slightly lift the bonnet »»» ⚠.
- Take out the bonnet support rod from the opening catch ❹ D and insert it into its clip ❸ C in the opening catch.
- Let the bonnet fall from a height of 30 cm into its clip; Do *not* apply pressure!

If the bonnet is not correctly closed, open it once again and close it correctly.

The bonnet is correctly closed when it is flush with the corresponding parts on the body-work.

### ⚠ WARNING

**If the bonnet is not correctly closed, it could suddenly open while driving leaving the driver without visibility. This could result in a serious accident.**

- After closing the bonnet, always check that it is properly secured by the locking mechanism in the lock carrier piece. The bonnet

**must be flush with the surrounding body panels.**

- While driving, if you notice that the bonnet is not correctly closed then stop immediately and close it correctly.
- Only open and close the bonnet when there is nobody within its range.

### ❶ CAUTION

- To avoid damage to the bonnet and to the windscreen wiper arms, only open it when the windscreen wipers are in place against the windscreen.
- Before driving, always lower the wiper arms.

## Engine oil

### Introduction

### ⚠ WARNING

**Incorrectly handling engine oil can cause injury and serious burns.**



- Always protect your eyes when handling engine oil.
- Oil is toxic and must be kept out of the reach of children.
- Engine oil should only be kept in its original packaging; the same goes for used oil until it is disposed of.

- Never store engine oil in empty food containers or bottles as other people may accidentally drink it.
- Regular contact with engine oil can be bad for the skin. If you come into contact with engine oil, wash your skin with soap and water.
- With the engine running, the engine oil gets extremely hot and can cause severe skin burns. Always wait until the engine has fully cooled.



### For the sake of the environment

Similar to the other service liquids, spilled engine oil can be bad for the environment. Collect these liquids in suitable containers and dispose of them while respecting the environment.

### Warning and control lamps

Flashes	Possible cause	Solution
	Engine oil pressure too low.	<p> <b>Stop the vehicle!</b></p> <p>Switch off the engine. Check the engine oil level, and if necessary, refill with  page 148.</p> <p>engine oil - If the warning indicator flashes although the oil level is correct, do <i>not</i> continue driving or leave the engine running. Otherwise, the engine could be damaged. Seek specialist assistance.</p>



### WARNING

Observe the safety warnings   in Control and warning lamps on page 40.

### Engine oil specifications

Replacement engine oil must strictly comply with the specifications.

The correct oil must be used to ensure the correct operation and long service life of the engine. The engine comes with a high-quality multigrade oil that can generally be used all year round.

Only use an engine oil that complies to SEAT standards whenever possible  . Only refill engine oil using approved engine oil in accordance with the corresponding VW standard ( table on page 147). All oils indicated are **synthetic multigrade oils**.

Engine oils are being continuously further developed. Technical services are constantly updated with any modifications. SEAT therefore recommends that you have the engine oil changed by a technical service.

Engines	Specifications of engine oil with a service dependent on time/distance travelled
44 kW - 55 kW Petrol engines	VW 504 00, VW 502 00
Natural gas engine	VW 502 00

### CAUTION

- Only use engine oils whose specifications are expressly approved by SEAT. The use of any other type of oil could cause engine damage!
- No additives should be used with engine oil. Any damage caused by the use of such additives would not be covered by the factory warranty.

## Checking the engine oil level and topping up

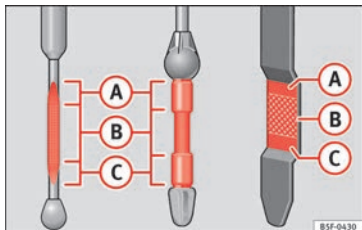

Fig. 107 Marked engine oil dipstick



Fig. 108 In the engine compartment: Engine oil filler cap.

### Preparations

- Park the vehicle on flat ground so that the engine oil reading is correct.
- The engine must be hot to be able to check the engine oil level. Stop the engine and wait

a few minutes for the oil to drain back into the sump.

- Open the bonnet [» page 143](#).
- The engine oil filler neck can be recognised by the symbol on the cap [» Fig. 108](#) and the dipstick by its coloured handle.

### Check the engine oil level

- Pull out the dipstick and wipe it on a clean cloth.
- Replace the dipstick, pushing it in as far as it will go. If the dipstick to measure engine oil has a mark, when you reintroduce it this mark should slot into the corresponding groove located on the upper end of the tube.
- Remove the dipstick again and check the engine oil level [» table on page 148](#).
- After reading the oil level, replace the dipstick in the tube completely.

### Engine oil topping up ranges

Fig. 107	Operations required depending on the engine oil level:
Area <b>A</b>	Do not top up oil .
Area <b>B</b>	You can add oil, but keep the level in this zone.
Area <b>C</b>	Oil <b>must</b> be added. After topping up the oil level should be in area <b>B</b> .

### Adding oil after checking the level

Only add engine oil in small quantities and in steps:

- Unscrew the cap from engine oil filler neck on the cylinder head [» Fig. 108](#). If you are not sure where the cap is, request help from a specialist.
- Only refill using approved SEAT engine oil in small quantities (no more than 0.5 ltr) [» page 147](#).
- To avoid adding too much oil, each time you add a quantity, wait until the oil has flowed into the crankcase so that it can be measured with the dipstick.
- Check the oil level before adding any more oil. Do not top up with too much engine oil [» !](#).
- When the oil level is in at least the [» Fig. 107](#) **B** zone, insert the dipstick into the tube fully to avoid engine oil escaping when the engine is running.
- After topping up the oil, ensure that the cap is screwed on to the filler neck correctly.

### WARNING

**Oil could catch fire if it comes into contact with hot engine components. This could lead to a fire, explosion and severe injuries.**

- Always ensure that after topping of oil, the engine oil filler cap is correctly tightened.

**This will avoid engine oil spilling onto hot engine parts when the engine is running.**

### ⓘ CAUTION

- If the engine oil level is above area **A** do not start the engine. Seek specialist assistance. Otherwise catalytic converter and engine damage may occur.
- When refilling or changing service liquids, ensure that you put the liquids into the right tank. Making a mistake when refilling could cause serious malfunctions and damage the engine!

### ♻️ For the sake of the environment

**The oil level must never be above area **A**. Otherwise oil can be drawn in through the crankcase breather and escape into the atmosphere via the exhaust system.**

## Engine oil consumption

The consumption of engine oil can be different from one engine to another and can vary during the useful life of the engine.

Depending on how you drive and the conditions in which the vehicle is used, oil consumption can be up to 1 ltr./2000 km. In the case of new vehicles, the consumption can exceed this figure over 5,000 kilometres. For this reason the engine oil level must be

checked at regular intervals, preferably when filling the tank and before a journey.

When the engine is working hard, for instance during sustained high-speed motorway cruising in summer or when climbing mountain passes, the oil level should preferably be kept within area **» Fig. 107 **A****.

## Changing the engine oil

The engine oil must be changed regularly according to the specifications of the Maintenance Programme.

Due to the problems linked with disposing of used oil and the need for suitable tools and special knowledge, always visit a specialised workshop to have the engine oil and filter changed. SEAT recommends taking your car in for technical service.

Detailed information on the service intervals is shown in the Maintenance Programme.

Engine oil additives make new oil darker after the engine has been running for a short period. This is normal and does not mean more frequent oil changes are required.

### ⚠️ WARNING

**If, in exceptional circumstances, you must change the engine oil yourself, please note the following:**

- Wear eye protection.
- Always wait until the engine has completely cooled to avoid being burned.
- Always keep your arms horizontal when unscrewing the oil drainage bolt so that it does not run down your arms.
- Use a suitable container large enough to collect all of the used oil in the engine.
- Never collect engine oil in empty food containers, cans, bottles or other containers as not all people are able to identify engine oil.
- Oil is toxic and must be kept out of the reach of children.

### ♻️ For the sake of the environment

**Before changing the engine oil, find a suitable location or service for proper disposal.**

### ♻️ For the sake of the environment

**Always dispose of engine oil with the utmost respect for the environment. Never dispose of used engine oil in places such as a garden, woods, drains, roads, paths, rivers and drainage systems.**

## Engine coolant

### Introduction

#### WARNING

Engine coolant is toxic!





- Only keep engine coolant in its original container, tightly shut and in a safe place.
- Never store engine coolant in empty food containers or bottles as other people may accidentally drink it.
- Always keep engine coolant out of reach of children.
- Ensure that the proportion of engine coolant additive corresponds to the lowest outside temperature to which the vehicle will be exposed.
- If the outside temperature is extremely low, the engine coolant could freeze causing the vehicle to stop. As this would also cause the heating to stop working, vehicle occupants without warm clothing could freeze.

#### For the sake of the environment

Coolants and additives can contaminate the environment. Collect any spilt fluids in suitable containers and dispose of them in accordance with legislation and with the utmost respect for the environment.

### Coolant warning lamp

Several warning and control lamps light up for a few seconds when the ignition is switched on, signalling that the function is being verified. They will switch off after a few seconds.

It lights up	Possible cause	Solution
	Excessive engine coolant temperature.	 <b>Stop the vehicle!</b> Stop the vehicle safely as soon as possible. Switch off the engine and let it cool.
	Insufficient engine coolant level.	 <b>!Stop the vehicle!</b> Check the engine coolant when the engine has cooled and, if it is low, refill with engine coolant » page 151.
	Engine coolant system faulty.	 <b>Do not drive any further.</b> Obtain professional assistance.

Flashes	Possible cause	Solution
	Engine coolant system faulty.	Seek specialist assistance.

#### WARNING

Observe the safety warnings »  in Control and warning lamps on page 40.

#### Note

On the display of the Portable Navigation System (supplied by SEAT) » page 123 an engine coolant temperature gauge can be seen.

### Engine coolant specifications

The engine cooling system is supplied from the factory with a specially treated mixture of water and, at least, 40 % of the additive **G 13** (TLW 774 J). The engine coolant additive is recognisable by its purple colour. This mixture of water and additive gives the necessary frost protection down to -25°C (-13 F) and protects the light alloy parts of the cooling system against corrosion. It also prevents scaling and considerably raises the boiling point of the coolant.

To protect the engine cooling system, the percentage of additive must *always* be at least 40 %, even in warm climates where anti-freeze protection is not required.

If greater frost protection is required in very cold climates, the proportion of additive can be increased. However, the percentage of additive should not exceed 60%, as this would

reduce the frost protection and, in turn, decrease the cooling capacity.

When the coolant is topped up, use a mixture of **distilled water** and, at least, 40 % of the G 13 or G 12 plus-plus (TL-VW 774 G) additive (both are purple) to obtain an optimum anticorrosion protection »» ❶. The mixture of G 13 with G 12 plus (TL-VW 774 F), G 12 (red) or G 11 (green-blue) engine coolants will significantly reduce the anticorrosion protection and should, therefore be avoided »» ❶.

### ⚠ WARNING

If there is not enough anti-freeze in the coolant system, the engine may fail leading to serious damage.

- Please make sure that the percentage of additive is correct with respect to the lowest expected ambient temperature in the zone in which the vehicle is to be used.
- When the outside temperature is very low, the coolant could freeze and the vehicle would be immobilised. In this case, the heating would not work either and inadequately dressed passengers could die of cold.

### ❶ CAUTION

The original additives should never be mixed with coolants which are not approved by SEAT. Otherwise, you run the risk of causing severe damage to the engine and the engine cooling system.

- If the fluid in the expansion tank is not purple but is, for example, brown, this indicates that the G 13 additive has been mixed with an inadequate coolant. The coolant must be changed as soon as possible if this is the case! This could result in serious faults and engine damage.

### ♻ For the sake of the environment

Coolants and additives can contaminate the environment. If any fluids are spilled, they should be collected and correctly disposed of, with respect to the environment.

## Checking the engine coolant level and refilling

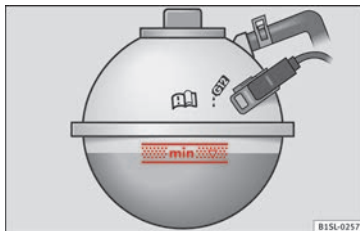

**Fig. 109** In the engine compartment: Marking on coolant expansion tank

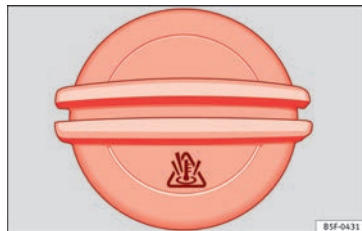

**Fig. 110** In the engine compartment: Coolant expansion tank cap

If the coolant level is low, the coolant warning indicator will light.

### Preparations

- Park the vehicle on even, flat and firm ground.
- Allow the engine to cool »» ❶.
- Open the bonnet ⚠ »» page 143.
- The coolant expansion tank is easily recognisable because of the symbol  on the cap »» **Fig. 110**.

### Checking the engine coolant level

- When the engine is cold, check the coolant level using the side marking on the expansion tank »» **Fig. 109**.
- If the level is below the “MIN” mark, top up with coolant. When the engine is hot it may be slightly above the marked area. »»



In the course of time, the brake fluid absorbs water from the ambient air. If there is too much water in the brake fluid, the brake system could be damaged. In addition, the boiling point of the brake fluid is significantly lowered. When the brake fluid contains too much water and the brakes are subject to considerable forces, bubbles of water vapour can form in the system. These bubbles can significantly reduce braking power, notably increasing braking distance, and could even result in the total failure of the brake system. Ensuring that the brake system is always functioning correctly is essential for your own safety and the safety of other road users  
»» ⚠.

### Brake fluid specifications

SEAT have developed a special brake fluid optimised for the brake systems of their vehicles. To ensure the optimum working of the brake system, SEAT recommends the use of brake fluid in accordance with the **VW 501 14 standard**. If this brake fluid is not available or another brake fluid is used for different reasons, use a brake fluid that complies with the United States standard FMVSS 116 DOT 4 or the German standard DIN ISO 4925 CLASS 4  
»» ⚠.

Brake fluids conforming to the standard VW 501 14, fulfil the American requirements of the FMVSS 116 DOT 4 standard and the German DIN ISO 4925 CLASS 4 standard.

However, fluids that comply with the American FMVSS 116 DOT 4 standard or the German DIN ISO 4925 CLASS 4 standard do not necessarily comply with the VW 501 14 standard. Always check the information on the brake fluid container and ensure that you are using suitable brake fluid.

A suitable brake fluid can be obtained from SEAT dealerships.

### Brake fluid level

The level of the brake fluid should always be between the MIN and MAX marks, or above the MIN mark  
»» ⚠.

It is not always possible to check the level of the brake fluid, as in some models the engine components make it difficult to see the brake fluid reservoir. If you cannot read the exact brake fluid level, consult a specialist.

The brake fluid level drops slightly when the vehicle is being used due to wear of the brake pads and the automatic readjustment of the brake.

### Changing the brake fluid

The brake fluid should be changed in accordance with the instructions given in the Maintenance Programme. Have the brake fluid changed by a specialised workshop. SEAT recommends taking your car in for technical service. This means that only brake fluid

complying with the required specifications will be used.

#### ⚠ WARNING

**If the brake fluid level is low or unsuitable/old brake fluid is used, the brake system may fail or braking power may be reduced.**

- Check the brake system and the brake fluid level regularly!
- The brake fluid should be changed regularly in accordance with the instructions given in the Maintenance Programme.
- When the brake fluid is used and brakes are subjected to extreme braking forces, bubbles of vapour form in the brake system. These bubbles can significantly reduce braking power, notably increasing braking distance, and could result in the total failure of the brake system.
- Always ensure that you use suitable brake fluid. Only used brake fluid that conforms to the VW 501 14 standard, FMVSS 116 DOT 4 standard or even the DIN ISO 4925 CLASS 4 standard. Other types of brake fluid could affect brake operation and reduce braking power. Do not use a brake fluid if the container does not specify compliance with the VW 501 14, FMVSS 116 DOT 4 or DIN ISO 4925 CLASS 4 standards.
- The replacement brake fluid must be new.

#### ⚠ WARNING

**Brake fluid is poisonous.**

»»

- To reduce the risk of poisoning, do not keep brake fluid in drinks bottles/containers or similar. Other people could drink from these recipients even if the contents are clearly marked.
- Always keep brake fluid in the original container; keep it correctly sealed and out of reach of children.

#### ⓘ CAUTION

Brake fluid damages the vehicle paintwork. Wipe off any brake fluid from the paintwork immediately.

#### ♻️ For the sake of the environment

Brake fluid is an environmental pollutant. Collect any spilt service fluids and allow a professional to dispose of them.

## Checking and topping up the windscreen washer reservoir with water



**Fig. 112** In the engine compartment: windscreen washer reservoir top

Check the water level in the windscreen washer reservoir regularly and top up as required.

- Open the bonnet **⚠️** » page 143.
- The washer reservoir is marked with the symbol  on the lid » **Fig. 112**.
- Check there is enough water in the reservoir.
- To top up, mix water with a window cleaner recommended by SEAT » **ⓘ**. Please follow the instructions for use found on the packaging.
- In cold weather, a special antifreeze should also be added to prevent the water from freezing » **⚠️**.

## Reservoir capacity

The washer bottle capacity is approximately 3 litres.

#### ⚠️ WARNING

Never mix an unsuitable antifreeze or other similar additives with the windscreen washer water. A greasy layer may be formed on the windscreen which will impair visibility.

- Use clean water with a window cleaner recommended by SEAT.
- If necessary, add a suitable antifreeze to the water in the reservoir.

#### ⓘ CAUTION

- Do not mix cleaning products recommended by SEAT with other products. This could lead to flocculation and may block the windscreen washer jets.
- When topping up service fluids, make absolutely certain that you fill the fluids into the correct reservoirs. Using the wrong fluids could cause serious malfunctions and engine damage!

## Vehicle battery

### Introduction





The battery is a component of the vehicle's electrical system.

Never work on the electrical system without fully understanding the operations required, the applicable safety standards and without the correct tools »» » ⚠ ! If required, have any work carried out by a specialised workshop. SEAT recommends taking your car in for technical service. Negligent work can cause serious injury.

### Location of the vehicle battery

The battery is located in the engine compartment.

### Explanation of the warning indications on the vehicle's battery

Symbol	Meaning
	Wear eye protection!
	Battery acid is very corrosive and caustic. Always wear protective gloves and eye protection!
	Fires, sparks, open flames and smoking are prohibited.
	A highly explosive mixture of gases is released when the battery is under charge.
	Keep children away from acid and batteries!

### ⚠ WARNING

**Working on the vehicle battery and the electrical system can cause corrosion, fire and**

**electric shocks. Always read and take into account the following warnings and safety standards before carrying out any work:**

- Before working on the battery, switch off the engine, the ignition and all electrical devices then disconnect the negative connection on the battery.
- Keep children away from acid and the battery itself!
- Wear eye protection.
- Battery acid is very corrosive and caustic. It can burn skin and cause blindness. When handling the battery, protect yourself from splashes of acids, above all your hands, arms and face.
- Do not smoke and never work close to places exposed to flames or sparks.
- Avoid sparks and electrostatic discharges when working with cables and electrical devices.
- Never short the battery terminals.
- Never use a damaged battery. It can explode. Replace a damaged battery immediately.
- Replaced damaged or frozen batteries as soon as possible. A flat battery can also freeze at temperatures close to 0 °C (+32 °F).

### ⚠ CAUTION

- Never disconnect the battery if the ignition is switched on or if the engine is running.

**This could damage the electrical system or electronic components.**

- Do not expose the battery to direct sunlight over a long period of time, as the intense ultraviolet radiation can damage the battery housing.
- If the car is left standing for long periods, protect the battery from extreme cold temperature so that it does not "freeze up" and become damaged.

### Warning lamp

It lights up	Possible cause	Solution
	Faulty generator.	Contact a specialised workshop. Have the electrical system checked. Disconnect any unnecessary electrical devices. The generator does not charge the battery while the vehicle is in motion.

Several warning and control lamps light up for a few seconds when the ignition is switched on, signalling that the function is being verified. They will switch off after a few seconds.



**⚠ WARNING**

Observe the safety warnings » ⚠ in Control and warning lamps on page 40.

### Checking the electrolyte level of the vehicle battery

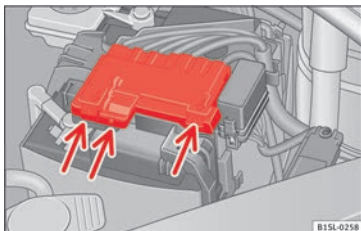

**Fig. 113** In the engine compartment: Remove the cover from the vehicle's battery.

The battery's electrolyte level should be checked regularly in high-mileage vehicles, in hot countries and in older batteries. Other batteries do not require maintenance.

Vehicles fitted with the Start-Stop system are equipped with special batteries. For technical reasons, the electrolyte level cannot be checked in these batteries.

### Preparations

- Prepare the vehicle for work in the engine compartment » page 143
- Open the bonnet ⚠ » page 143.
- Press on the tabs » Fig. 113 (arrows) in the direction of the arrows and lift the battery cover up.

### Checking the battery electrolyte level

- Make sure there is sufficient lighting to clearly recognise the colours. Never use flames or shiny objects as a light source.
- Depending on the level of acid, the Magic eye on the top of the battery will change colour.

Colour indicator	Necessary operations
<i>Light yellow or colourless</i>	The electrolyte level of the vehicle's battery is too low. Have the battery checked and, where applicable, replaced by a specialised workshop.
<i>Black</i>	The electrolyte level of the vehicle's battery is correct.

**⚠ WARNING**

**Working with the vehicle battery involves a risk of corrosion, explosions and electric shock.**

- **Never tilt the vehicle battery. Battery acid could spill out of the openings for the release of gases and cause corrosion damage.**
- **Never open the vehicle battery.**
- **If battery acid splashes on you, immediately rinse your eyes and skin abundantly with water for several minutes. Then seek medical care immediately.**
- **If acid is swallowed by mistake, consult a doctor immediately.**

### Charging, replacing and connecting or disconnecting the battery

#### Charging the battery

The vehicle battery should be charged by a specialised workshop only, as batteries using special technology have been installed and they must be charged in a controlled environment » ⚠. SEAT recommends taking your car in for technical service.

#### Replacing a vehicle battery

The battery has been developed to suit the conditions of its location and has special safety features. If the battery must be replaced, consult a technical service for information on electromagnetic compatibility, the size and maintenance, performance and safety requirements of the new battery in your vehicle before you purchase one. SEAT

recommends you have the battery replaced by a technical service.

Use only maintenance-free genuine batteries conforming to TL 825 06 and VW 7 50 73 Standards. These standards must be dated April 2008 or later.

Vehicles fitted with the Start-Stop system are equipped with a special battery. Therefore, this battery must only be replaced by another with the same specifications.

### Disconnecting the vehicle's battery

If you must disconnect the battery from the electrical system, please note the following:

- Switch off the ignition and all electrical equipment.
- The vehicle must be unlocked before disconnecting the battery, otherwise the alarm will be triggered.
- First disconnect the negative cable and then the positive ► .

### Connecting the vehicle's battery

- Before reconnecting the battery, switch off the engine and all electrical devices.
- First reconnect the positive cable and then the negative ► .

Different control lamps may light up after connecting the battery and switching the ignition on. They will be turned off after a short

trip at a speed of between 15-20 km/h (10-12 mph). If the warning indicators remain lit, please visit a specialised workshop to have the vehicle checked.

If the battery has been disconnected for a long time, it is possible that the next service date is not displayed or calculated correctly ►► page 36. Respect the maximum service intervals permitted ►► **Booklet Maintenance Programme.**

### Automatic device disconnection

The intelligent vehicle electrical system automatically implements a range of measures to prevent the battery from discharging when high demands are made on it:

- The idling speed is increased so that the alternator provides more electricity.
- Where necessary, the power to the most powerful devices is reduced or even completely disconnected.
- On starting the engine, the power supply from the 12-volt power sockets and the cigarette lighter may be interrupted for a short time.

The on-board management program cannot always prevent the battery from running flat. For example, if the ignition is left on for a long period with the engine off or if the side lights or parking lights are left on while the vehicle is stationary.

### Why the battery runs flat:

- When stationary for a long time without starting the engine, particularly if the ignition is switched on.
- Use of electrical devices with the engine switched off.

#### **WARNING**

**Incorrectly securing the battery or using the wrong battery can cause short-circuits, fire and serious injuries.**

- Always use only maintenance-free batteries, protected to prevent a leak, and whose properties, specifications and size correspond to the standard battery.

#### **WARNING**

**A highly explosive mixture of gases is released when the battery is under charge.**

- The batteries should be charged in a well-ventilated room only.
- Never charge a frozen or recently thawed battery. A flat battery can also freeze at temperatures close to 0 °C (+32 °F).
- Always replace a battery which has frozen.
- Battery cables not correctly connected may cause a short circuit. Reconnect first the positive cable and then the negative cable. ►►

**ⓘ CAUTION**

- Never disconnect the battery if the ignition is switched on or if the engine is running. This could damage the electrical system or electronic components.
- Never plug accessories that supply current, such as solar panels or a battery charger, to the 12-volt power socket or the cigarette lighter. This could damage the vehicle's electrical system.

**♻️ For the sake of the environment**

Dispose of the battery in an environment-friendly manner. Batteries contain toxic substances such as sulphuric acid and lead.

**♻️ For the sake of the environment**

Battery acid can contaminate the environment. Collect any spilt service fluids and dispose of them correctly.

## Wheels and tyres

### Wheels

#### Introduction

SEAT recommend that all work on tyres and wheels is carried out by a specialised workshop. These workshops have the necessary special tools and replacement parts, trained personnel and facilities for disposing of the old tyres while respecting the environment. SEAT recommends taking your car in for technical service.

**⚠️ WARNING**

The vehicle cannot be totally controlled or braked if the tyres (new or used) are worn or damaged.

- Incorrect use of wheels and tyres could make driving more dangerous and result in serious accidents and damage.
- All four wheels must be fitted with radial tyres of the same type, size (rolling circumference) and the same tread pattern.
- New tyres do not give maximum grip and will not have reached their maximum braking capacity to start with, and therefore need running in. To prevent accidents and major damage, extreme caution should be taken for the first 600 km.

- Check tyre pressures regularly and ensure they are maintained at the pressures indicated. If the tyre pressure is too low, they could overheat, resulting in tread detachment or even burst tyres.
- Never drive on damaged (punctured, cut, cracked or dented) or worn tyres. Driving on damaged or worn tyres could result in burst tyres, serious accidents or damage. Worn or damaged tyres must be replaced immediately.
- Never exceed the maximum permitted speed or loads specified for the type of tyre fitted on your vehicle.
- The effectiveness of driver and brake assist systems also depends on the grip of the tyres.
- If you notice unusual vibration or if the vehicle pulls to one side when driving, stop the car immediately and check the tyres and wheels for damage.
- To minimise the risk of losing control of the vehicle or causing a serious accident, never undo the bolted joints of beadlock wheels.
- Never mount used tyres or wheels if you are not sure of their previous history. They may be damaged, although the damage is not immediately visible.
- Old tyres, even if they have never been used, may lose air or burst unexpectedly while driving, especially at high speeds, resulting in serious accident and injury. If tyres are over six years old, they should only be used in an emergency and with extreme caution.

 Note

For technical reasons, it is not generally possible to use the wheels from other vehicles. In some cases, this may also be true for the same model of wheel. Please refer to the vehicle documentation or ask at a technical service.

### About your tyres and wheels

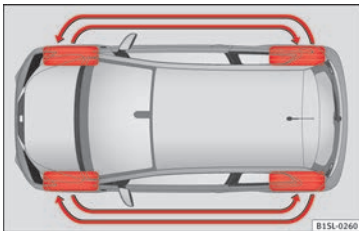

**Fig. 114** Diagram for changing wheels

The tyres of a vehicle are the components which are subjected to most stress and are the most underestimated. Tyres are very important, as the support offered by their narrow surface is the only point of contact between the vehicle and the road.

The service life of tyres is dependent on tyre pressure, driving style, the care they receive and the correct fitting.

The tyres and wheel rims are an essential part of the vehicle's design. The tyres and rims approved by SEAT are specially matched to the characteristics of the vehicle and our critical to good road holding and safe handling.

#### Avoiding damage to tyres and wheels

- If you have to drive over a kerb or similar obstacle, drive very slowly and as near as possible at a right angle to the kerb.
- Inspect the tyres regularly for damage (punctures, cuts, cracks, dents).
- Remove any foreign bodies found on the outside of the tyre tread and ensure that **they have not passed through the wall of the tyre** » page 163.
- In addition, the instructions for tyre control systems should always be observed.
- Replace damaged or worn tyres as soon as possible » page 163.
- Regularly check tyres for non-visible damage » page 163.
- Never exceed the maximum permitted speed or loads specified for the type of tyre fitted on your vehicle » page 167.
- Do not allow tyres (including the spare wheel) to come into contact with aggressive substances, grease, oil, fuel or brake fluid » .

- Lost valve caps should be replaced immediately.

#### Tyres with directional tread pattern

Tyres with directional tread pattern have been designed to operate best when rotating in only one direction. An arrow on the tyre sidewall indicates the direction of rotation on tyres with directional tread » page 167. Always observe the direction of rotation indicated when mounting the wheel. This guarantees optimum grip and helps to avoid aquaplaning, excessive noise and wear.

If the tyre is mounted in the opposite direction of rotation, drive with extreme caution, as the tyre is no longer being used correctly. This is of particular importance when the road surface is wet. Change the tyre as soon as possible or remount it with the correct direction of rotation.

#### Interchanging tyres

To ensure that the wear is equal on all tyres the wheels should be changed round from time to time according to the system » Fig. 114. The useful life of all the tyres will then be about the same time.

SEAT recommends you take the vehicle to a specialised workshop to have the tyres changed.



### Tyres that are over 6 years old

Tyres are subject to an ageing process as a result of physical and chemical processes. This may affect their performance. Tyres which are stored for long periods of time without being used, harden and become more fragile than tyres which are in constant use.

SEAT recommends that tyres over six years old are replaced with new tyres. This also applies to tyres (including the spare wheel) which appear to be in perfect condition on the outside and which have a tread depth within the values stipulated by the Law »»» ⚠.

The date of manufacture, part of the tyre identification number (TIN), indicates the age of the tyre (TIN) »»» page 167.

### Storing tyres

Mark tyres when you remove them to indicate the direction of rotation (left, right, forwards, backwards). This ensures you will be able to mount them correctly when you replace them. When removed, the wheels and/or tyres should be stored in a cool, dry and preferably dark location. Do **not** place tyres mounted on the wheel in a vertical position.

Protect tyres not mounted on wheels from dirt by storing them in suitable bags and standing them on the ground on their tread.

#### ⚠ WARNING

**Aggressive fluids or substances could result in visible or invisible damage with the consequent risks.**

- Always ensure that tyres do not come into contact with chemical products, oil, grease, fuel, brake fluid or other aggressive substances.

#### ⚠ WARNING

**Old tyres, even if they have never been used, may lose air or burst unexpectedly while driving, resulting in serious accident or damage.**

- If tyres are over six years old, they should only be used in an emergency and with extreme caution.

#### ♻ For the sake of the environment

**Old tyres must be disposed of by qualified personnel according to the laws in the country concerned.**

### Wheel rims

The design of wheel bolts is matched to the rims. If different rims are fitted, the correct wheel bolts with the right length and correctly shaped bolt heads must be used. This ensures that wheels are fitted securely and that the brake system functions correctly »»» page 174.

For technical reasons, it is not generally possible to use the wheels from other vehicles. In some cases, this may also be true for the same model of wheel.

The tyres and rims approved by SEAT are specially matched to the characteristics of the vehicle and are critical to good road holding and safe handling.

**Note for Italy:** A SEAT Service Centre should be consulted whether different sized wheels or tyres to those originally fitted by SEAT may be fitted, as well as the combinations allowed between the front axle (axle 1) and back axle (axle 2).

### Wheel bolts

Wheel bolts must be tightened to the correct torque »»» page 174.

### Beadlock wheel rims

Beadlock wheel rims have various components. These are joined together by special bolts using a special procedure. This ensures good performance, a better seal, improved safety and wheel run out. Therefore, worn rims should always be replaced and must only be repaired in a specialised workshop. SEAT recommends visiting a technical service »»» ⚠.

### Wheel rims with bolted trims

Wheel rims may be fitted with interchangeable trim parts which are attached to the rim using self-locking bolts. Worn trims should only be replaced at a specialised workshop. SEAT recommends visiting a technical service »» ⚠.

#### ⚠ WARNING

The use of worn or damaged wheel rims could make driving more dangerous and result in serious accidents and damage.

- Only wheel rims which have been approved for use with your vehicle should be used.
- Inspect wheel rims regularly for damage and replace as required.

#### ⚠ WARNING

If the bolted joints of wheel rims with bolted ring trims are not correctly tightened or loosened, this could result in serious accident.

- Never loosen the bolted joints of wheel rims with bolted ring trims.
- Any work relating to wheel rims with bolted rims should be carried out at specialised workshop. SEAT recommends taking your car in for technical service.

### Replacement of wheel rims and new tyres

#### New tyres

- When tyres are new, drive with extreme caution for the first 600 km, as all tyres need to be *run-in*. Tyres which have not been run-in do not have such good grip »» ⚠ or braking capacity »» ⚠.
- All four wheels must be fitted with radial tyres of the same type, size (rolling circumference) and the same tread pattern.
- The tread depth of new tyres may vary, according to the type and make of tyre and the tread pattern.

#### Replacing tyres

- Where possible, always replace both wheels on an axle (both wheels on the front axle or both wheels on the rear axle) »» ⚠.
- Only replace used tyres with those authorised by SEAT for the corresponding type vehicle. Pay special attention to size, diameter, and maximum load and speed capacity.
- Never use tyres which are larger than SEAT approved tyres. If the tyres are too big, they may knock or rub against the chassis or other components, resulting in damage.

#### ⚠ WARNING

New tyres do not give maximum grip and will not have reached their maximum braking capacity to start with, and therefore need running in.

- To prevent accidents and major damage, extreme caution should be taken for the first 600 km.

#### ⚠ WARNING

There should be adequate space between the tyres and the vehicle in accordance with the vehicle design. If this is not the case, the tyres may rub against parts of the running gear, chassis or brake lines, leading to faults in the brake system or to tread detachment, and the risk of burst tyres.

- The true tyre dimension should not be greater than the dimensions of tyres manufactured and approved by SEAT and should not rub against parts of the vehicle.

#### i Note

Although tyres may be shown as being the same size, the true dimensions of different types of tyre may vary with respect to the nominal size, or tread patterns may be different.

#### i Note

If you use tyres that are approved by SEAT, you can be sure that the true tyre dimensions »»

will be correct for your vehicle. For other tyre models, the tyre vendor should provide the manufacturer's certificate with the tyre, indicating that this type of tyre is suitable for your vehicle. This certificate should always be carried with the vehicle.

## Tyre pressures



**Fig. 115** Position of tyre pressure specification plate

The correct tyre pressures for tyres fitted at the factory is shown on a label and is valid for summer and winter tyres. The label

» **Fig. 115** is located on the driver's door pillar.

Under-inflation or over-inflation will reduce the life of the tyres considerably and also impair the car's handling » **△**. It is essential to maintain the correct tyre pressures, especially if driving at **high speeds**. Incorrect tyre pressure causes premature wear and could cause tyre blow-out.

The pressure should therefore be checked at least once a month and before starting a journey.

As a general rule, the pressures given are for **cold tyres**. When the tyres are hot, the pressures are greater.

Never deflate a hot tyre in order to obtain the required pressure. This could result in very low tyre pressures which may lead to sudden blow-outs.

### Checking tyre pressures

Check tyre pressures only when the vehicle has not been driven for more than a few kilometres at low speeds in the past three hours.

- The tyre pressures should be checked regularly, and only when the tyres are cold. Always check all tyres, including the spare wheel. Tyre pressures should be checked more often in colder regions, and only when the vehicle has not been driven recently. Always use a correctly-operating tyre gauge.

- Adjust tyre pressures to the loads carried in the vehicle.
- After adjusting the tyre pressure, check that the caps are properly screwed on.

The **spare wheel** or **temporary spare wheel** must be at the maximum pressure specified.

### **△** WARNING

If tyre pressures are too high or too low, the tyre may deflate or burst suddenly while driving. This could result in a serious accident.

- If the tyre pressure is too low, they could overheat, resulting in tread detachment or even burst tyres.
- When driving at high speeds and/or fully loaded, the tyre could suddenly overheat, burst or be subject to tread detachment, with the resultant loss of control of the vehicle.
- Tyre pressures which are too high or too low reduce the service life of the tyre, affecting the vehicle's performance.
- Tyre pressures should be checked regularly, at least once a month and before long journeys.
- Adjust the pressures of all the tyres to the vehicle load.
- Never deflate excess pressure from hot tyres.

### ⚠ CAUTION

- Take care not to tilt the manometer when placing it on the valve. Otherwise, the valve may be damaged.
- If tyre valves are not protected by caps, or if the caps are not screwed on correctly, they may become damaged. Check that the caps are identical to the standard caps and have been correctly tightened.

### 🌿 For the sake of the environment

Under-inflated tyres will increase fuel consumption.

### Tread depth and wear indicators



Fig. 116 Tyre tread: tread wear indicators

#### Tread depth

Certain driving conditions require a deeper tread, as well as needing the tread to be ap-

proximately the same on the front and rear tyres. This is particularly important when driving in winter, in cold temperatures and on wet roads » » » ⚠.

The minimum tread depth required by law in the majority of cases is 1.6 mm, measured in the tread grooves next to the tread wear indicators. Observe legal requirements in each country.

The performance of **winter tyres** is much reduced when the tread has worn to 4 mm.

The tread depth of new tyres may vary, according to the type and make of tyre and the tread pattern.

#### Wear indicators on the tyre

The original tyres on your vehicle have 1.6 mm high » » » Fig. 116 tread wear indicators running across the tread. A number of these indicators are equally spaced around the tyre tread. Certain marks on the tyre walls (e.g. the letters "TWI" or other symbols) indicate the position of the wear indicators.

Tread wear indicators indicate if a tyre is worn. They must always be replaced before the tyre tread has worn to the level of the indicator.

### ⚠ WARNING

Driving with worn tyres is dangerous, and may lead to loss of control of the vehicle with serious consequences.

- Tyres must be replaced before the wear indicators are at the same level as the tread pattern.
- Worn tyres have significantly reduced grip, especially on wet surfaces, increasing the risk of "aquaplaning".
- Worn tyres make control of the vehicle more difficult in normal or difficult driving conditions, increasing the braking distance and the risk of skidding.

### Damaged tyres

Damage to wheels and tyres is often not immediately visible. If you notice unusual **vibration** or the car **pulling to one side**, this may indicate that one of the tyres is damaged » » » ⚠.

- Slow down immediately if you think you have a damaged wheel.
- Check the wheels and tyres for damage.
- If tyres are worn, stop driving and seek qualified assistance.
- If there is no visible exterior damage, drive slowly and carefully to the nearest specialised workshop and have the vehicle checked. » »

### Foreign bodies in the tyre

- Do not remove foreign bodies if they have penetrated through the tyre wall!
- You should obtain professional assistance immediately.

### Wear of tyres

The wear of tyres depends on a number of factors, for example:

- Driving style.
- Unbalanced wheels.
- Running gear settings.

*Driving style:* Driving round bends quickly or sudden acceleration or braking speed accelerates tyre wear. When the driving style is normal, if the tyres wear too quickly, have the running gear settings checked at a specialised workshop.

*Wheel run-out:* The wheels on new vehicles are balanced. However, certain circumstances may lead to imbalance (run-out), which is detected as vibrations in the steering wheel. Run-out leads to wear of the steering and suspension. In the event of run out, the wheels should be balanced again. When a new wheel is fitted, it should be balanced again.

*Running gear settings:* an incorrectly positioned running gear increases the wear of tyres and affects your safety while driving. If

tyres wear too quickly, have the wheel alignment checked at a specialised workshop.

#### WARNING

**If you notice unusual vibration or the car pulls to one side while driving, this may indicate that one of the tyres is damaged.**

- Reduce speed immediately and stop, while observing the highway code.
- Check the wheels and tyres for damage.
- Never carry on driving on worn tyres or wheels. Request qualified assistance immediately.
- If there is no visible exterior damage, drive slowly and carefully to the nearest specialised workshop and have the vehicle checked.

### Tyre monitoring system\* (L)



**Fig. 117** Centre console: tyre monitor system button

The tyre control lamp compares wheel revolutions and with it, the wheel diameter of each wheel using the ESC. If the diameter of a wheel changes, the tyre control lamp (L) lights up. The wheel diameter changes when:

- Tyre pressure is insufficient.
- The tyre structure is damaged.
- The vehicle is unbalanced because of a load.
- The wheels of one axle are under more pressure (for example, driving with a trailer or on steep slopes).
- The vehicle is fitted with snow chains.
- The temporary spare wheel is fitted.
- The wheel on one axle is changed.

### Tyre pressure adjustment

On adjusting tyre pressure or changing one or more wheels, the **»» Fig. 117** button must be kept pressed down, with the ignition on, until an acoustic signal is heard.

If the wheels are under excessive load (for example, driving with a trailer or heavy load), the tyre pressure must be increased to the recommended value for a full load (see the sticker on the inside of the fuel flap). If the tyre monitor system button is pressed down, the new tyre pressures are confirmed.

**The tyre pressure control lamp (L) lights up**

If the tyre pressure of a wheel is much lower than the value set by the driver, then the tyre pressure control lamp »» » ⚠ will light up.

**⚠ WARNING**

- When the tyre pressure control lamp lights up, reduce speed immediately and avoid any sudden turning or braking manoeuvre. Stop when possible, and check the tyre pressure and status.
- The driver is responsible for maintaining correct tyre pressures. For this reason, tyre pressure must be regularly checked.
- Under certain circumstances (e.g. when driving in a sporty manner, in winter conditions or on a dirt track) the tyre control lamp may light up belatedly or may function incorrectly.

**i Note**

If the battery is disconnected, the yellow warning lamp (L) lights up after turning the ignition on. This should turn off after a brief journey.

**Spare wheel or temporary spare wheel\***

**Fig. 118** In the luggage compartment: hand controlled wheel for securing the spare wheel

**Removing the spare wheel**

- Open the rear lid and lift the luggage compartment shelf »» » page 73.
- If necessary, remove the boot variable floor »» » page 73.
- Lift up the carpet from the recess and remove it from the luggage compartment.
- If necessary, take out the vehicle tool kit with the container.
- Completely remove the hand controlled wheel from the centre of the spare wheel »» » Fig. 118 by turning it in an anticlockwise direction, and take out the spare wheel.

**Storing the replaced wheel**

- Pull back the carpet.
- With the wheel rim facing downwards, situate the replaced wheel in the spare wheel well so that the wheel rim central hole coincides with the opening.
- Turn the hand controlled wheel with the shank screwed clockwise until the replaced wheel is secured.
- If necessary, store the vehicle tool in the container, inside the boot.
- Replace the carpet on the boot floor.
- Lower the rear shelf.
- Close the rear lid.

**If the spare wheel is different to the rest of the vehicle tyres**

If the spare tyre is not the same as the tyres that are mounted on the vehicle - for example with winter tyres or the temporary spare wheel - you should only use the spare tyre for a short period of time and drive with extra care »» » ⚠.

Refit the normal road wheel as soon as possible.

**Please observe driving advice:**

- Do not drive faster than 80 km/h (50 mph).
- Avoid heavy acceleration, hard braking and fast cornering.

- Snow chains on the temporary spare wheel are not permitted » page 169.
- After mounting the spare wheel or the temporary spare wheel, check the tyre pressure as soon as possible » page 162.

It is advisable to check the spare wheel or temporary spare wheel tyre pressure when checking the rest of the vehicle wheels at least once a month. The spare wheel should have the highest pressure allowed for the vehicle » page 162. The sticker situated on the temporary spare wheel shows the tyre pressure.

**⚠ WARNING**

**Incorrect handling of the spare wheel or the temporary spare wheel can cause loss of ve-**

**hicle control, producing collisions or other serious accidents and injury.**

- **Never use the spare wheel or the temporary spare wheel if it is damaged or worn to the wear indicator.**
- **In some vehicles the spare wheel is smaller than the original tyres. This can be seen on a sticker showing the text “80 km/h” and “50 mph”. This text indicates the maximum velocity permitted for this type of tyre.**
- **Never drive faster than 80 km/h (50 mph). Avoid powerful acceleration, hard braking and taking corners at high speed.**
- **Never drive more than 200 km with a temporary spare wheel fitted to the drive axle.**
- **Replace the temporary spare wheel for a normal wheel as soon as possible. The compact temporary spare wheel is only intended for temporary use over short distances.**

- **The temporary spare wheel must always be secured with the factory supplied wheel bolts.**
- **You should never use more than one temporary spare wheel.**
- **After mounting the temporary spare wheel, check the tyre pressure as soon as possible » page 162.**
- **Snow chains on the temporary spare wheel are not permitted.**

**i Note**

**Wherever possible, secure the spare wheel, temporary spare wheel or the replaced wheel safely in the luggage compartment. In vehicles with anti-puncture kit, it is not possible to secure the defective wheel.**

## Tyre code



**Fig. 119** Universal code on tyres

- ① Radial
- ② Rim diameter code
- ③ Load index & speed rating
- ④ DOT tyre identification number
- ⑤ Severe snow conditions
- ⑥ Tyre ply composition and materials used
- ⑦ Max. load rating
- ⑧ Treadwear, traction and temperature grades
- ⑨ Max. permissible inflation pressure
- ⑩ Passenger car tyre
- ⑪ Nominal width of tyre in millimetres
- ⑫ Ratio of height to width (aspect ratio)

Tyre code (example)	Meaning	
<i>Make, logotype</i>	<i>Manufacturer</i>	
<i>Product name</i>	Name of tyre assigned by manufacturer.	
P255 / 55 R 18	Size:	
	P	Passenger vehicle code.
	255	Nominal width between walls, in mm.
	55	Height/width ratio in %
	R	Tyre type (R indicates "radial").
	18	Rim diameter in inches



## Advice

Tyre code (example)	Meaning	
109 H	Load index»» page 169 and speed rating »» page 169.	
XL	Reinforced tyres (“Reinforced”).	
M+S or M/S or 	Winter tyres code (mud and snow tyres).	
RADIAL TUBELESS	Radial tyre without inner tube.	
E4 ...	E-mark certifying tyre complies with international legislation followed by a number denoting the country granting the authorisation. The authorisation number (several digits) is shown below.	
DOT BT RA TY5 1709	Tyre identification number ( <b>TIN</b> <sup>a</sup> , may be only on interior wall of wheel) and date of manufacture:	
	DOT	The tyre complies with the legal requirements of the US Department of Transport, responsible for tyre safety regulations.
	BT	Place of manufacture code.
	RA	Information about manufacturer and tyre size.
	TY5	Manufacturer's tyre specifications.
	1709	Date of manufacture: Week 17 of 2009.
TWI	This identifies the position of the Tread Wear Indicator »» page 163.	
Made in Germany	Country of manufacture.	
MAX LOAD 615 KG	US load rating, indicating maximum permitted load per tyre.	
MAX INFLATION 350 KPA (51 PSI)	US limit, indicating maximum permitted tyre pressure.	
SIDEWALL 1 PLY RAYON	Information about tyre wall components: 1 layer of rayon (artificial silk).	
TREAD 4 PLYS 1 RAYON + 2 STEEL + 1 NYLON	Information about tread components: In the example, there are 4 layers below the tread: 1 layer of rayon (artificial silk), 2 layers of steel reinforcement and 1 layer of nylon.	

**Information for the end consumer concerning the comparative values of the established base tyres (standardised test procedures) »» page 134:**

Tyre code (example)	Meaning
TREADWEAR 220	Relative service life of the tyre, with respect to specific US standard test.
TRACTION A	Braking capacity of tyre on wet surface (AA, A, B or C).
TEMPERATURE A	Tyre temperature resistance at higher test speeds (A, B or C).
<b>If the tyre has other markings, these are specific tyre manufacturer codes or specific national codes, e.g. for Brazil or China.</b>	

<sup>a)</sup> The letters TIN refer to the tyre serial number.

### Tyres with directional tread pattern

Tyres with directional tread pattern have been designed to operate best when rotating in only one direction. An arrow on the tyre sidewall indicates the direction of rotation on tyres with directional tread. Always observe the direction of rotation indicated when mounting the wheel. This guarantees optimum grip and helps to avoid aquaplaning, grip, noise and wear.

If the tyre is mounted in the opposite direction of rotation, drive with extreme caution, as the tyre is no longer being used correctly. This is of particular importance when the road surface is wet. Change the tyre as soon as possible or remount it with the correct direction of rotation.

### Tyre load rating

The load rating code indicates the maximum load in kilogrammes each wheel can carry (load capacity).

78	425 kg
81	462 kg
83	487 kg
85	515 kg
87	545 kg
91	615 kg

### Speed rating

The speed rating indicates the maximum speed permitted for the tyres.

P	max. 150 km/h (93 mph)
Q	max. 160 km/h (99 mph)
R	max. 170 km/h (106 mph)
S	max. 180 km/h (112 mph)
T	max. 190 km/h (118 mph)
U	max. 200 km/h (124 mph)
H	max. 210 km/h (130 mph)
V	max. 240 km/h (149 mph)
Z	max. 240 km/h (149 mph)

W max. 270 km/h (168 mph)

Y max. 300 km/h (186 mph)

Some manufacturers use the letters “ZR” for tyres with a maximum authorised speed above 240 km/h.

### Snow chains

When using snow chains, applicable local legislation and maximum permitted speed limits must be observed.

In winter weather, snow chains not only help to improve grip but also improve the braking capacity.

The fitting of chains is permitted **only on front wheels** and **with the following combinations of wheel trims and tyres:**

»

Tyre size	Wheel rim
165/70 R14	5   x 14 offset of 35
175/65 R14	

SEAT recommends you ask a technical service for further information on wheel, tyre and chain sizes.

Wherever possible use fine-link chains measuring less than 15 mm including the lock.

Remove wheel hub covers and trim rings before fitting snow chains » ⚠. The wheel bolts should be covered with caps for safety reasons. These are available from technical services.

### Temporary spare wheel

For technical reasons, snow chains must not be used on the compact temporary spare wheel » page 165.

If it is necessary to fit chains with the temporary spare wheel in use, install the wheel on the rear axle in the event of a fault in a front wheel. Then, fit the rear wheel that is free, instead of the damaged front wheel. In this situation, observe the rotating direction of the wheels. SEAT recommends attaching the snow chains before fitting the wheel.

### ⚠ WARNING

The use of unsuitable or incorrectly fitted chains could lead to serious accidents and damage.

- Always the appropriate snow chains.
- Observe the fitting instructions provided by the snow chain manufacturer.
- Never exceed the maximum permitted speeds when driving with snow chains.

### ⓘ CAUTION

- Remove the snow chains to drive on roads without snow. Otherwise they will impair vehicle handling, damage the tyres and wear out very quickly.
- Wheel rims may be damaged or scratched if the chains come into direct contact with them. SEAT recommends the use of covered snow chains.

### ⓘ Note

**Snow chains are available in different sizes according to the vehicle type.**

## Emergencies

### In case of emergency

#### First aid kit, warning triangle and fire extinguishers\*

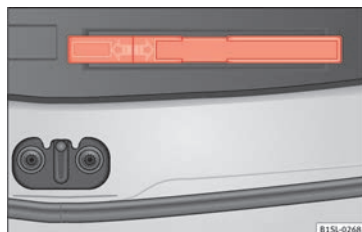

**Fig. 120** In the luggage compartment: storage compartment for the warning triangle

#### Warning triangle

In some vehicle equipment it is possible to store the warning triangle model shown in a storage compartment of the luggage compartment » **Fig. 120**.

#### First-aid kit

The first aid kit must comply with legal requirements. Check the expiry date of the contents of the first aid kit.

### Fire extinguisher

A fire extinguisher can be stored in a holder in the passenger seat footwell.

The fire extinguisher must conform to legal requirements, be ready for use and be checked regularly. Check the certification seal on the extinguisher.

#### WARNING

**Loose objects in the vehicle interior can be violently thrown in case of a sudden manoeuvre or braking and especially in accidents causing serious injury.**

- Secure or store fire extinguishers, first aid kit, reflective vests and warning triangle securely in the vehicle.



### Protecting yourself and securing the vehicle



**Fig. 121** Dash panel: Button for switching the hazard lights warning system on and off.

Always fulfil legal requirements for securing a broken down vehicle. In a number of countries it is now obligatory, for example, to turn on the hazard warning lights and use a reflective safety vest » page 170.

For your own safety and that of other passengers, the following points should be observed in the order given:

1. Park the vehicle a safe distance from traffic and on suitable ground » .
2. Turn on the hazard warning lights with the button  » **Fig. 121**.
3. Apply the handbrake firmly » page 89.
4. Put the gearbox lever in neutral or the selector lever in position **N** » page 93.

5. Switch off the engine and remove the key from the ignition.
6. Have all occupants leave the vehicle and move to safety, for example behind a guard rail.
7. When leaving the vehicle, take all keys with you.
8. Place an emergency warning triangle to indicate the position of your vehicle to other road users.
9. Allow the engine to cool and check if a specialist is required.

When being towed with the hazard warning lights on, a change in direction or traffic lane can be indicated as usual using the turn signal lever. The hazard lights will be interrupted temporarily.

#### Examples of when to use the hazard warning lights:

- If the vehicles ahead suddenly slow down or reach the end of a traffic jam, to warn the vehicles behind.
- In case of an emergency.
- If the vehicle breaks down.
- When tow-starting or towing.

Always comply with the applicable laws regarding the use of hazard warning lights.

If the hazard warning lights are not working, you must use an alternative method of »

drawing attention to your vehicle. This method must comply with traffic legislation.

#### **⚠ WARNING**

A faulty vehicle in traffic represents a risk of accident for the driver and for other road users.

- Stop the vehicle safely as soon as possible. Park the vehicle a safe distance from surrounding traffic to lock all the doors in case of an emergency. Turn on the hazard warning lights to warn other road users.
- Never leave children or disabled people alone in the vehicle if the doors are to be locked. In case of an emergency, passengers will be trapped inside the vehicle. Individuals locked in the vehicle can be exposed to very high or very low temperatures.

#### **⚠ WARNING**

The components of the exhaust system reach very high temperatures. This could cause a fire and considerable damage.

- Always park your vehicle so that no part of the exhaust system can come in contact with flammable materials (such as dried grass or fuel).

#### **Note**

- The vehicle battery will discharge and run down if the hazard warning lights remain on for too long (even with the ignition turned off).

- For some vehicles, the brake lights will blink when braking suddenly at speeds of approximately 80 km/h (50 mph) to alert vehicles to the rear. If braking continues, the hazard warning lights system will automatically be turned on at a speed of less than approximately 10 km/h (6 mph). The brake lights remain lit. Upon accelerating, the hazard warning lights will be automatically turned off.

## Vehicle tool kit\*

### Introduction

When securing the vehicle in case of a breakdown, please note the legal requirements for each country.

### Vehicle tool kit

For vehicles with a factory-fitted spare wheel or temporary spare wheel, in addition to winter wheels, the luggage compartment may contain additional vehicle tools »» page 172.

#### **⚠ WARNING**

When the vehicle tool kit, tire mobility set and spare wheel are loose in the interior they can be violently thrown in case of a sudden manoeuvre or braking and especially in accidents, causing serious injury.

- Ensure that the vehicle tool kit, the tire mobility set and the spare wheel or temporary

spare wheel are safely secured in the luggage compartment.

#### **⚠ WARNING**

Unsuitable or damaged vehicle tools can cause injury or accidents.

- Never work with inappropriate or damaged tools.

### Location

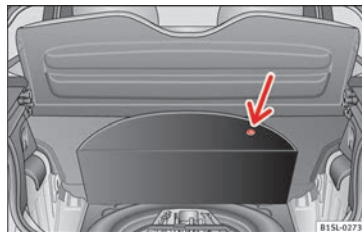

**Fig. 122** In the luggage compartment: Raised carpet.

The vehicle tool kit, spare wheel, temporary spare wheel and the tire mobility set are stored in the luggage compartment under the carpeted floor panel »» **Fig. 122**.

- If necessary, remove the boot variable floor »» page 73.

- Raise the carpet at the recess (arrow)

»» Fig. 122.

### Note

**After use, return the jack to its initial position using the handle in order to securely store it in the vehicle.**

### Accessing the vehicle tool kit and tyre mobility system in vehicles fitted with the SEAT SOUND 7 speaker system (with subwoofer)\*

- Open the boot hatch and lift the shelf.
- If necessary, remove the boot variable floor »» page 76.
- Lift up the carpet from the recess and remove it from the luggage compartment.
- Disconnect the subwoofer's speaker cable.
- Completely remove the hand-controlled wheel from the centre of the subwoofer speaker by turning it anti-clockwise.
- Take out the subwoofer, which is on top of the tools and tyre mobility system.
- When finished, place the tools and system back in the same way and place as before to ensure the speaker sits properly in its housing.

- Place the subwoofer in the direction of the arrow and with the word "FRONT" facing forward.
- Reconnect the speaker cable and firmly rotate the securing wheel clockwise so that the subwoofer is firmly in place.

### Components

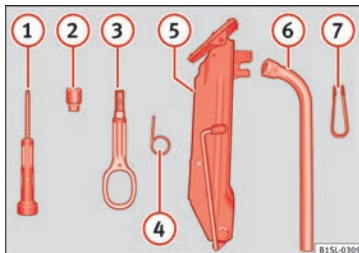

Fig. 123 Components of the vehicle tool kit

The vehicle tool kit depends on the vehicle equipment. The following is a description for a vehicle with all options.

### The individual elements of the vehicle tool kit »» Fig. 123

- 1 Screwdriver with hexagon socket in the handle for screwing and unscrewing the wheel bolts. The screwdriver bit is inter-

changeable. The screwdriver may be found underneath the wheel spanner.

- 2 Adapter for anti-theft bolt. SEAT recommend you carry the wheel bolt adapter in the vehicle tool kit at all times. The **code number** of the anti-theft wheel bolt is stamped on the front of the adapter. In case it is lost, another adapter can be ordered using this number. Note the anti-theft bolt code for the wheels and keep it in a place other than the vehicle.
- 3 Towline anchorage, removable.
- 4 Wire hook for pulling off the wheel cover, integral hubcaps and the wheel bolt caps.
- 5 Jack. Before storing the jack in the tool kit, fold its hook. The crank must then be folded tight against the side of the jack in order for it to be safely stored.
- 6 Wheel spanner.
- 7 Wheel bolt cap clips.

### Note

**The jack does not generally require any maintenance. If required, it should be greased using universal type grease.**

## Changing a wheel

### Introduction

Some vehicle versions and models do not have a factory-fitted jack or box spanner. In this case, we recommend consulting a Specialised workshop to change the wheel.

You should only change the wheels yourself if the vehicle is parked in a safe place, you are familiar with the procedure and safety standards and you have all the necessary tools! Otherwise, you should seek professional assistance.

#### WARNING

Changing a wheel can be dangerous, especially on the hard shoulder. Please observe the following rules to minimise the risk of injury:

- Stop the vehicle safely as soon as possible. Park at a safe distance from surrounding traffic to change a wheel.
- When changing a wheel, keep all passengers, and particularly children, a safe distance away from the work area.
- Turn on the hazard warning lights to warn other road users.
- Ensure the ground on which you park is flat and solid. If necessary, support the jack on a wide solid base.

- If you are changing a wheel yourself, you should be familiar with the required procedure. Otherwise, you should seek professional assistance.
- Only use suitable tools that are not damaged when changing a wheel.
- Always stop the engine, apply the hand-brake lever firmly and place the selector lever in position P, or engage a gear for a manual gearbox to reduce the risk of the vehicle moving accidentally.
- Have the tightening torque of the wheel bolts checked as soon as possible with a reliable torque wrench.

#### WARNING

If the wheel trims are not appropriate or not fitted correctly, they could cause major accidents or damage.

- Incorrectly mounted wheel trims may come off while driving and endanger other road users.
- Damaged trims must never be mounted on the wheels.
- Always ensure that the brake ventilation and cooling is not cut off or blocked. This is also valid if hubcaps are fitted later. If there is not enough air, you may require significantly longer braking distances.

#### CAUTION

Remove and remount wheel trims taking care to avoid damage to the vehicle.

### Hubcaps



Fig. 124 Remove the hubcap of the steel wheel trim

In order to access the wheel bolts, first remove the hubcap.

#### Removing and fitting the hubcap

- To remove, take the vehicle tool kit wire hook and attach it to the edge of the wheel trim » Fig. 124.
- Remove the trim by pulling it in the direction of the arrow.
- To replace the hubcap, press the hubcap against the trim until it clicks into place.

The caps protect the wheel bolts and should be remounted after changing the tyre.

### Full hubcaps



Fig. 125 Removing the full hubcap

### Removing the full hubcap

- Take the wheel brace and the wire hook from the vehicle tool kit »» page 172.
- Hook the wire through one of the grooves on the hubcap.
- Insert the wheel brace onto the wire hook »» Fig. 125 and pull the hub cap in the direction shown by the arrow.

### Fitting hubcaps

Press the hubcap against the wheel so that the space for the valve fits over the tyre valve. Make sure that the hubcap is correctly fitted all the way around the wheel. If you are using

an anti-theft wheel lock, screw it in the opposite position to the valve.

### Wheel bolt caps



Fig. 126 Removing the wheel bolt caps

### Removal

- Fit the plastic clip (vehicle tools »» page 172) over the cap until it clicks into place »» Fig. 126.
- Remove the cap with the plastic clip.

The caps protect the wheel bolts and should be remounted after changing the tyre.

The **anti-theft wheel locking bolt** has a special cap. This only fits on anti-theft locking bolts and is not for use with standard wheel bolts.

### Wheel bolts



Fig. 127 Changing a wheel: Slacken the wheel bolts.

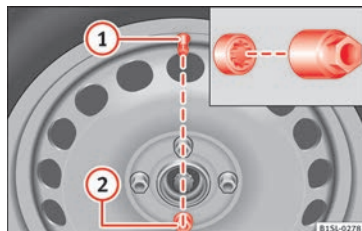

Fig. 128 Changing a wheel: Tyre valve ① and position of anti-theft wheel locking bolt ②.

Only use the tool supplied with the vehicle to loosen the wheel bolts.

Loosen the wheel bolts only about one turn before raising the vehicle with the jack. »»

If the wheel bolt is very tight, you may be able to loosen it by pushing down on the end of the wheel brace carefully with your foot. Hold on to the vehicle for support and take care not to slip.

### Loosening wheel bolts

- Fit the wheel brace as far as it will go over the wheel bolt »» Fig. 127.
- Hold the wheel brace at the end and rotate the bolt approximately *one* turn anticlockwise »» ⚠.

### Loosening anti-theft wheel bolts

For wheels with full hubcap, the anti-theft wheel lock must be threaded into position »» Fig. 128 ② before mounting the hubcap. Otherwise it will not be possible to mount the entire hubcap.

- Take the adapter for anti-theft wheel bolts out of the vehicle tool kit.
- Insert the adapter onto the wheel bolt »» Fig. 128. Push it on as far as it will go.
- Fit the wheel brace onto the adapter as far as possible.
- Hold the wheel brace at the end and rotate the bolt approximately *one* turn anticlockwise »» ⚠.

### Important information about wheel bolts

The wheel rims and bolts have been designed to be fitted to factory options. If different rims are fitted, the correct wheel bolts with the right length and correctly shaped bolt heads must be used. This ensures that wheels are fitted securely and that the brake system functions correctly.

In some circumstances, wheel bolts from the same model vehicle should not be used.

### Wheel bolt tightening torque

The prescribed tightening torque for wheel bolts for steel and alloy wheels is **110 Nm**. Have the tightening torque of the wheel bolts checked as soon as possible with a reliable torque wrench.

If wheel bolts are rusty and it is difficult to tighten them, the threads should be replaced and cleaned **before checking the tightening torque**.

Never grease or lubricate wheel bolts or the wheel hub threads. Although they have been tightened to the prescribed torque, they could come loose while driving.

#### WARNING

**If the wheel bolts are not fitted correctly they could be released while driving leading to loss of vehicle control and serious damage.**

- **Only use wheel bolts which correspond to the wheel rims in question.**
- **Never use different wheel bolts.**
- **The bolts and threads should be clean, free of oil and grease and easy to thread.**
- **To loosen and tighten the wheel bolts, always use the wheel brace supplied with the vehicle.**
- **Loosen the wheel bolts only about one turn before raising the vehicle with the jack.**
- **Never grease or lubricate wheel bolts or the wheel hub threads. Although they have been tightened to the prescribed torque, they could come loose while driving.**
- **Never loosen the bolted joints of wheel rims with bolted ring trims.**
- **If the wheel bolts are not tightened to the correct torque, they may come loose while driving, and the bolts and rims may come out. If the tightening torque is too high, the wheel bolts and threads can be damaged.**

## Raising the vehicle with the jack

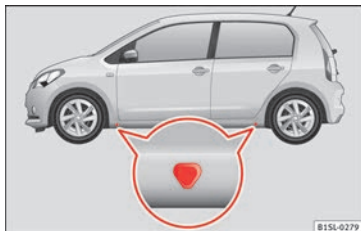

Fig. 129 Jack position points

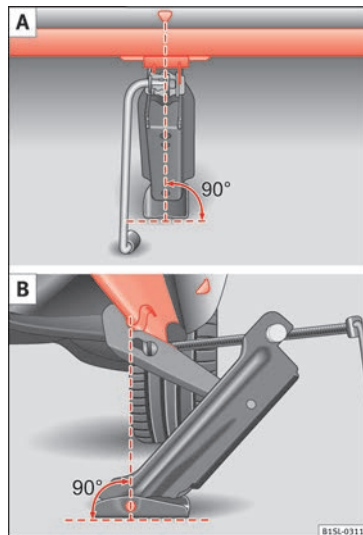

Fig. 130 Jack mounted on the left rear part of the vehicle

The jack may be applied only at the jacking points shown (marks on chassis) » Fig. 129. Always the relevant jacking point for the wheel to be changed » ⚠.

Raise the vehicle using only the designated jacking points.

## ⚠ WARNING

If the vehicle is not correctly raised, it could fall off the jack causing serious injury. Please observe the following rules to minimise the risk of injury:

- You should only use a jack approved by SEAT for your vehicle. Other jacks, even those approved for other SEAT models, might slip out of place.
- The ground should be firm and flat. If the ground is sloped or soft then the vehicle could slip and fall off the jack. If necessary, support the jack on a wide solid base.
- If the ground is slippery, such as tiles, place a non-slip surface (a floor mat, for instance) beneath the jack to avoid slipping.
- Only fit the jack at the prescribed jacking points. The claw of the jack should grip the reinforcement nerve on the underbody » Fig. 130.
- You should never place a body limb such as an arm or leg under a raised vehicle that is solely supported by the jack.
- If you have to work underneath the vehicle, you must use suitable stands additionally to support the vehicle, there is a risk of accident!.
- Never raise the vehicle if it is tilting to one side or the engine is running.
- Never start the engine when the vehicle is raised. The vehicle may come loose from the jack due to the engine vibrations.

## Changing a wheel



**Fig. 131** Changing a wheel: loosen wheel bolts with the socket at the end of the wheel brace

### Removing the wheel

- Loosen the wheel bolts » page 175.
- Jacking up the vehicle » page 177.
- Using the hexagonal socket in the wheel brace » **Fig. 131**, unscrew the slackened wheel bolts and place them on a clean surface.
- Take off the wheel.

### How to use the spare wheel or temporary spare wheel

Check the direction of rotation of the tyre » page 167, Tyre code.

- Place the spare wheel or temporary spare wheel into position.

- Replace the wheel bolts and tighten *slightly* using the hexagonal socket on the end of the wheel brace.
- To tighten the anti-theft locking wheel bolts use the corresponding adaptor.
- Lower the car with the jack.
- Tighten all of the wheel bolts clockwise » **△**. Tighten the bolts in diagonal pairs (not in a circle).
- Put the caps, trim or full hubcap back on » page 174.

### **△** WARNING

**If the wheel bolts are not treated suitably or not tightened to the correct torque then this could lead to loss of vehicle control and to a serious accident.**

- **All the wheel bolts and hub threads should be clean and free of oil and grease. The wheel bolts should be easily tightened to the correct torque.**
- **The hexagonal socket in the wheel brace should be used for turning wheel bolts only. Do not use it to loosen or tighten the wheel bolts.**

### After changing the wheel

- Clean the vehicle tools, if necessary and put them away in the luggage compartment foam holder » page 172.

- Store the spare wheel, the temporary spare wheel or the changed wheel securely in the luggage compartment.
- Have the tightening torque of the wheel bolts checked as soon as possible with a torque wrench » page 176.
- Have the flat tyre replaced as quickly as possible.

## Tyre repair

### TMS (Tyre Mobility System)\*

The Anti-puncture kit\* (Tyre Mobility System) will reliably seal punctures caused by the penetration of a foreign body of up to about **4 mm** in diameter. **Do not remove foreign objects, e.g. screws or nails, from the tyre.**

After inserting the sealant residue in the tyre, you must again check the tyre pressure about 10 minutes after starting the engine.

You should only use the tyre mobility set if the vehicle is parked in a safe place, you are familiar with the procedure and you have the necessary tyre mobility set! Otherwise, you should seek professional assistance.

### The tyre sealant must not be used in the following cases:

- If the wheel rim has been damaged.

- In outside temperatures below -20 °C (-4 °F).
- In the event of cuts or perforations in the tyre greater than 4 mm.
- If you have been driving with very low pressure or a completely flat tyre.
- If the sealant bottle has passed its use by date.

### **⚠ WARNING**

Using the tyre mobility system can be dangerous, especially when filling the tyre at the roadside. Please observe the following rules to minimise the risk of injury:

- Stop the vehicle safely as soon as possible. Park it at a safe distance from surrounding traffic to fill the tyre.
- Ensure the ground on which you park is flat and solid.
- All passengers and particularly children must keep a safe distance from the work area.
- Turn on the hazard warning lights to warn other road users.
- Use the tyre mobility system only if you are familiar with the necessary procedures. Otherwise, you should seek professional assistance.
- The tyre mobility set is intended for temporary emergency use only until you can reach the nearest specialised workshop.
- Replace the repaired tyre with the tyre mobility set as soon as possible.

- The sealant is a health hazard and must be cleaned immediately if it comes into contact with the skin.
- Always keep the tyre mobility set out of the reach of small children.
- Never use an equivalent jack, even if it has been approved for your vehicle.
- Always stop the engine, apply the hand-brake lever firmly and engage gear if using a manual gearbox, in order to reduce the risk of vehicle involuntary movement.

### **⚠ WARNING**

A tyre filled with sealant does not have the same performance properties as a conventional tyre.

- Never drive faster than 80 km/h (50 mph).
- Avoid heavy acceleration, hard braking and fast cornering.
- Drive for only 10 minutes at a maximum speed of 80 km/h (50 mph) and then check the tyre.

### **♻ For the sake of the environment**

Dispose of used or expired sealant observing any legal requirements.

### **i Note**

- A new bottle of sealant can be purchased at SEAT dealerships.

- Take into account the separate instruction manual of the tyre mobility set\* manufacturer.

### **Contents of the tyre mobility system\***

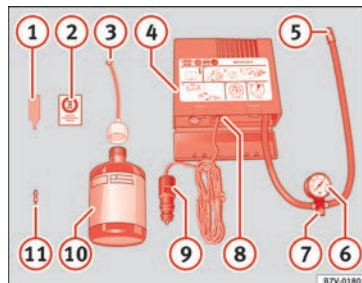

**Fig. 132** Standard representation: Contents of the tyre mobility system.

The tyre mobility set is located underneath the floor covering in the luggage compartment. It includes the following components  
**»» Fig. 132:**

- 1 Tyre valve remover
- 2 Sticker indicating maximum speed "max. 80 km/h" or "max. 50 mph"
- 3 Filler tube with cap
- 4 Air compressor

- 5 Tube for inflating tyres
- 6 Warning provided by tyre pressure monitoring system<sup>1)</sup>
- 7 Air bleed screw<sup>2)</sup>
- 8 ON/OFF switch
- 9 12 volt connector
- 10 Bottle of sealant
- 11 Spare tyre valve

The **valve insert remover** ① has a gap at the lower end for a valve insert. The valve insert can only be screwed or unscrewed in this way. This also applies to its replacement part ⑪.

## Sealing and inflating a tyre

### Sealing a tyre

- Unscrew the tyre valve cap.
- Use the corresponding enclosed extractor » Fig. 132 ① to unscrew the tyre valve insert. Place the valve insert on a clean surface.
- Vigorously shake the sealant bottle » Fig. 132 ⑩ for several seconds.
- Screw the inflator tube » Fig. 132 ③ securely into the sealant bottle in a clockwise

direction. The seal on the mouth of the bottle moves automatically.

- Remove the lid from the filling tube » Fig. 132 ③ and screw the open end of the tube into the tyre valve.
- Hold the tyre sealant can upside down and fill the **complete** contents of the can into the tyre.
- Remove the tyre sealant bottle from the valve.
- Screw the valve insert again with the corresponding enclosed extractor » Fig. 132 ① into the tyre valve.

### Inflating the tyre

- Securely screw the tyre inflator tube » Fig. 132 ⑤ of the compressor into the tyre valve.
- Check whether the air bleed screw » Fig. 132 ⑦ is closed.
- Start the vehicle engine and leave it running.
- Attach the connector » Fig. 132 ⑨ to a 12 volt socket of the vehicle » page 72.
- Connect the air compressor with the ON/OFF switch » Fig. 132 ⑧.

- Keep the air compressor running until it reaches 2.0 to 2.5 bar (29-36 psi / 200-250 kPa) » **△. Maximum operation time 8 minutes** » ④.
- Disconnect the air compressor.
- If it is not possible to achieve an air pressure of 2.0 to 2.5 bar (29-36 psi / 200-250 kPa), unscrew the tyre inflator tube from the tyre valve.
- Move the vehicle some 10 metres forward or backward so that the sealant is evenly distributed in the tyre interior.
- Securely screw the compressor tyre inflator tube into the tyre valve and repeat the inflation process.
- If the indicated pressure can still not be reached, the tyre is too badly damaged. The tyre cannot be sealed with the anti-puncture kit. Do not continue driving. You should obtain professional assistance » **△.**
- Disconnect the air compressor and unscrew the flexible inflator tube from the tyre valve.
- When the tyre pressure is between 2.5 and 2.0 bars, immediately continue driving without exceeding 80 km/h (50 mph).
- After **10 minutes**, Check the pressure again » page 181.

<sup>1)</sup> It can also be integrated in the compressor.

<sup>2)</sup> In its place, the compressor may have a button.

**⚠ WARNING**

When inflating the wheel, the air compressor and the inflator tube may become hot.

- Protect hands and skin from hot parts.
- Do not place the hot flexible inflator tube or hot air compressor on flammable material.
- Allow them to cool before storing the device.
- If it is not possible to inflate the tyre to at least 2.0 bars (29 psi / 200 kPa), the tyre is too badly damaged. The sealant is not in a good condition to seal the tyre. Do not continue driving. Seek specialist assistance.

**ⓘ CAUTION**

Switch off the air compressor after a maximum of 8 operational minutes to avoid overheating! Before switching on the air compressor again, let it cool for several minutes.

**Check after 10 minutes of driving**

Screw in the inflator tube » Fig. 132 ⑤ again and check the pressure on the gauge ⑥.

**1.3 bar (19 psi / 130 kPa) and lower:**

- **Stop the vehicle!** The tyre cannot be sealed sufficiently with the tyre mobility set.
- You should obtain professional assistance » ⚠.

**1.4 bar (20 psi / 140 kPa) and higher:**

- Set the tyre pressure to the correct value again » page 158.
- Carefully resume your journey until you reach the nearest specialised workshop without exceeding 80 km/h (50 mph).
- Have the damaged tyre replaced.

**⚠ WARNING**

Driving with an unsealed tyre is dangerous and can cause accidents and serious injury.

- Do not continue driving if the tyre pressure is 1.3 bar (19 psi / 130 kPa) and lower.
- Seek specialist assistance.

**Starting assistance****Introduction**

If the engine fails to start because of a discharged battery, the battery of another vehicle can be used to start the engine. Before starting, check the magic eye on the battery » page 154.

For starting assistance, jump lead cables conforming to the standard DIN 72553 are required (see the cable manufacturer instructions). The cable section in vehicles with petrol engine must be at least 25 mm<sup>2</sup>.

**⚠ WARNING**

Incorrect use of jump leads and incorrectly jump starting could cause the battery to explode resulting in serious injury. Please observe the following rules to minimise the risk of a battery explosion:

- The battery providing current must have the same voltage (12V) and approximately the same capacity (see markings on battery) as the flat battery.
- Never charge a frozen or recently thawed battery. A flat battery can also freeze at temperatures close to 0 °C (+32 °F).
- If a battery is frozen and/or has been frozen then it must be replaced.
- A highly explosive mixture of gases is released when the battery is being charged. Always keep lit cigarettes, flames, sparks and fire far from the battery. Never use a mobile telephone when connecting and removing the jump leads.
- Charge the battery only in well ventilated areas given that when the battery is charged by outside assistance, it creates a mix of highly explosive gases.
- Jump leads should never enter into contact with moving parts in the engine compartment.
- Never switch the positive and negative poles or connect the jump leads incorrectly.
- Note the instruction manual provided by the manufacturer of the jump leads. »

**ⓘ CAUTION**

To avoid considerable damage to the vehicle electrical system, note the following carefully:

- If the jump leads are incorrectly connected, this could result in a short circuit.
- The vehicles must not touch each other, otherwise electricity could flow as soon as the positive terminals are connected.

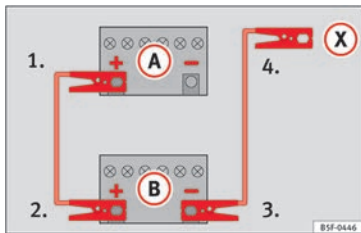
**How to jump start: description**

**Fig. 133** Diagram of connections for vehicles without Start-Stop system.

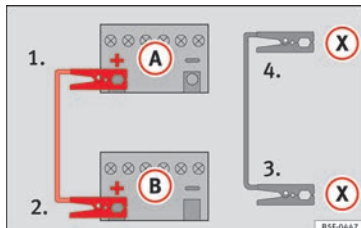

**Fig. 134** Diagram of connections for vehicles with Start-Stop system.

**Jump lead terminal connections**

1. Switch off the ignition of both vehicles  
»» ⚠.
2. Connect one end of the *red* jump lead to the positive (+) terminal of the vehicle with the flat battery (A) »» Fig. 133.
3. Connect the other end of the *red* jump lead to the positive terminal (+) in the vehicle providing assistance (B).
4. **For vehicles without Start-Stop system:** connect one end of the *black* jump lead to the negative terminal (-) of the vehicle providing the current (B) »» Fig. 133.  
– **For vehicles with Start-Stop system:** connect one end of the *black* jump lead (X) to a suitable ground terminal, to a solid piece of metal in the engine block, or to the engine block itself »» Fig. 134.

5. Connect the other end of the *black* jump lead (X) to a solid metal component bolted to the engine block or to the engine block itself of the vehicle with the flat battery. Do not connect it to a point near the battery (A).
6. Position the leads in such a way that they cannot come into contact with any moving parts in the engine compartment.

**Starting**

7. Start the engine of the vehicle with the boosting battery and let it run at idling speed.
8. Start the engine of the vehicle with the flat battery and wait 2 or 3 minutes until the engine is “running”.

**Removing the jump leads**

9. Before you remove the jump leads, switch off the dipped beam headlights (if they are switched on).
10. Turn on the heater blower and heated rear window in the vehicle with the flat battery. This helps minimise voltage peaks which are generated when the leads are disconnected.
11. When the engine is running, disconnect the leads in reverse order to the details given above.

Connect the battery clamps so they have good metal-to-metal contact with the battery terminals.

If the engine fails to start, switch off the starter after about 10 seconds and try again after about 1 minute.

### WARNING

• Please note the safety warnings referring to working in the engine compartment  
» page 143.

• The battery providing assistance must have the same voltage as the flat battery (12V) and approximately the same capacity (see imprint on battery). Failure to comply could result in an explosion.

• Never use jump leads when one of the batteries is frozen. Danger of explosion! Even after the battery has thawed, battery acid could leak and cause chemical burns. If a battery freezes, it should be replaced.

• Keep sparks, flames and lighted cigarettes away from batteries, danger of explosion. Failure to comply could result in an explosion.

• Observe the instructions provided by the manufacturer of the jump leads.

• Do not connect the negative cable from the other vehicle directly to the negative terminal of the flat battery. The gas emitted from the battery could be ignited by sparks. Danger of explosion.

• Do not attach the negative cable from the other vehicle to parts of the fuel system or to the brake line.

• The non-insulated parts of the battery clamps must not be allowed to touch. The jump lead attached to the positive battery terminal must not touch metal parts of the vehicle, this can cause a short circuit.

• Position the leads in such a way that they cannot come into contact with any moving parts in the engine compartment.

• Do not lean on the batteries. This could result in chemical burns.

### Note

The vehicles must not touch each other, otherwise electricity could flow as soon as the positive terminals are connected.

## Towing and tow starting

### Introduction

When towing or tow starting, respect the legal requirements.

**For technical reasons, it is not possible to tow a vehicle if the battery is flat.**

### WARNING

A vehicle with a flat battery should never be towed.

• Never remove the key from the ignition lock. Otherwise, the steering wheel lock could suddenly lock. The vehicle would not be controlled and a serious accident could ensue.

### WARNING

When towing the vehicle, the handling and braking efficiency change considerably. Please observe the following instructions to minimise the risk of serious accidents and injury:

• As the driver of the vehicle being towed:

– The brake must be depressed much harder as the brake servo does not operate. Always remain aware to avoid collision with the towing vehicle.

– More strength is required at the steering wheel as the power steering does not operate when the engine is switched off.

• As the driver of the towing vehicle:

– Accelerate gently and carefully.

– Avoid sudden braking and manoeuvres.

– Brake well in advance than usual and brake gently.

»

**ⓘ CAUTION**

- Carefully fit and remove the towline anchorage and its cover to avoid damage to the vehicle (e.g. paintwork).
- When towing, fuel could enter the catalytic converter and cause damage!

**ⓘ Note**

Fitting a towline anchorage to the rear bumper is not possible. The vehicle is not suitable for towing other vehicles.

**Instructions for tow starting**

In general, the vehicle should not be started by towing. Jump-starting is much more preferable » page 181.

For technical reasons, the following vehicles can **not** be tow started:

- Vehicles with an automatic gearbox.
- If the vehicle battery is flat, it is possible that the engine control unit does not operate correctly.

**However, if your vehicle must absolutely be tow-started (manual gearbox):**

- Put it into second or third gear.
- Keep the clutch pressed down.

- Switch on the ignition and the hazard warning lights.
- Release the clutch when both vehicles are moving.
- As soon as the engine starts, press the clutch and move the gear lever into neutral. This helps to prevent a collision with the towing vehicle.

**ⓘ CAUTION**

**When tow-starting, fuel could enter the catalytic converter and damage it.**

**Notes on towing****Tow rope or tow bar**

When towing, the tow bar is the safest and vehicle friendly way. You should only use a tow rope if you do not have a tow bar.

A tow rope should be slightly elastic to avoid damage to both vehicles. It is advisable to use a tow rope made of synthetic fibre or similarly elastic material.

Only secure the tow rope or tow bar to the towline anchorage or specially designed fitting.

**Towing vehicles with an automatic gearbox**

Note the following for a towed vehicle:

- Make sure the gear selector lever is in the **N** position.
- Do not drive faster than 50 km/h (30 mph) when towing a vehicle.
- Do not tow further than 50 km (30 miles).
- If a breakdown truck is used, the vehicle must be towed with the front wheels raised.

**Situations in which the vehicle should not be towed**

In the following cases, the vehicle should not be towed but transported on a trailer or special vehicle:

- If the vehicle gearbox does not contain lubricant due to a fault.
- If the battery is flat and the steering cannot be unlocked as a result, the electronic steering lock and electronic parking brake cannot be disengaged.
- If the vehicle to be towed has an automatic gearbox and the distance to be covered is greater than 50 km (30 miles).

**ⓘ Note**

**The vehicle can only be towed if the steering lock electronic gearbox lock is deactivated. If the vehicle has no power supply or there is an electric system fault, the engine must be started using jump leads to deactivate the steering column electronic gearbox lock.**

## Fitting the front towline anchorage



**Fig. 135** On the right-hand side of the front bumper: Remove the cover.



**Fig. 136** On the right-hand side of the front bumper: Screw in the towline anchorage.

The location for the removable tow ring is on the right-hand side of the front bumper behind a cover » **Fig. 135**.

The towline anchorage should always be kept in the vehicle.

Note the instructions for towing » **page 184**.

### Fitting the towline anchorage

- Take the towline anchorage from the vehicle tool kit in the luggage compartment » **page 172**.
- Press the upper part of the cover » **Fig. 135** (arrow) to disengage and release the cover.
- Remove the cover and leave it hanging from the vehicle.
- Screw in the tow ring into its housing **anti-clockwise** as far as it will go » **Fig. 136** » **!**. Use a suitable tool to firmly tighten the towline anchorage in its location.
- After towing, remove the tow ring by turning it **clockwise**.
- Place the cover's upper tab on the opening of the bumper and carefully guide the lower tab on the edge of the opening. If necessary, press the lower tab from below.
- Press the lower area of the cover until the lower tab engages in the bumper.

#### **!** CAUTION

**The towline anchorage must always be completely and firmly tightened. Otherwise, it could be released while towing and tow-starting.**

## Towing advice

Towing requires some experience, especially when using a tow rope. Both drivers should be familiar with the technique required for towing. For this reason, inexperienced drivers should abstain.

While driving, avoid excessive traction forces and jerking. When towing on an unpaved road, there is always a risk of overloading and damaging the anchorage points.

If the vehicle is towed, with the hazard warning lights on and the ignition switched on, the turn signal may be used to indicate changes of direction. Simply operate the turn signal lever as usual. Meanwhile, the hazard warning lights will go off. When the turn signal lever is returned to the rest position, the hazard warning lights will be turned on automatically.

### Notes for the driver of the towed vehicle

- Keep the ignition running to prevent the steering wheel from locking and also to allow the use of the turn signals, horn, windscreen wipers and washers.
- As the power assisted steering does not work if the engine is not running, you will need more strength to steer than normally.
- The brake must be depressed must harder as the brake servo does not operate. Avoid hitting the towing vehicle.

»

- Note the instructions and information contained in the Instruction Manual for the vehicle to be towed.

### Notes for the driver of the towing vehicle

- Accelerate gently and carefully. Avoid sudden manoeuvres.
- Brake well in advance than usual and brake gently.
- Note the instructions and information contained in the Instruction Manual for the vehicle to be towed.

## Emergency locking and unlocking

### Introduction

The doors and rear lid can be locked manually and partially opened, for example if the key or the central locking is damaged.

#### **⚠ WARNING**

Opening and closing doors carelessly can cause serious injury.

- If the vehicle is locked from outside, the doors and windows cannot be opened from the inside.
- Never leave children or disabled people alone in the car. They could be trapped in the

car in an emergency and will not be able to get themselves to safety.

- Depending on the time of the year, temperatures inside a locked and closed vehicle can be extremely high or extremely low resulting in serious injuries and illness or even death, particularly for young children.

#### **⚠ WARNING**

Getting in the way of the doors and the rear lid is dangerous and can lead to serious injury.

- Open and close the doors and the rear lid only when there is nobody in the way.

#### **⚠ CAUTION**

When opening and closing in an emergency, carefully disassemble components and then reassemble them carefully to avoid damage to the vehicle.

### Manually locking and unlocking the driver door

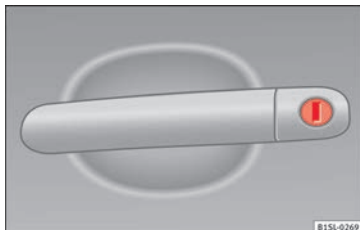
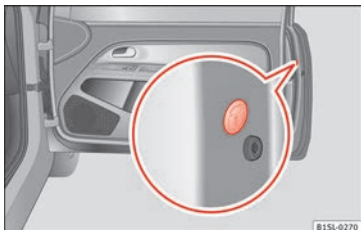

**Fig. 137** Driver side door handle with lock cylinder

As a general rule, when the driver door is locked all other doors are locked. Unlocking manually only opens the driver door.

- Unfold the key shaft if necessary  
» page 43.
- Insert the key shaft into the lock cylinder to unlock or lock the vehicle » **Fig. 137**.

### Manually locking the passenger side door



**Fig. 138** To the front of the passenger side door: Emergency lock, hidden by a rubber cap.



**Fig. 139** Emergency locking of the vehicle using the vehicle key

The passenger door can be manually locked.

- Door open.

- Remove the rubber cap to the front of the door. The rubber cap is marked with a lock symbol **🔒** » **Fig. 138**.
- Unfold the key shaft if necessary » **page 43**.
- Insert the key shaft horizontally into the opening and moved the coloured lever forward » **Fig. 139**.
- Replace the rubber cap and close the door.
- Check if the door is locked.
- Have the vehicle checked by a specialised workshop.

#### **i** Note

**The doors can be opened and unlocked individually from the inside by pulling the inside door handle. If necessary, pull the inner door release lever twice » **page 45**.**

### Emergency unlocking the rear lid

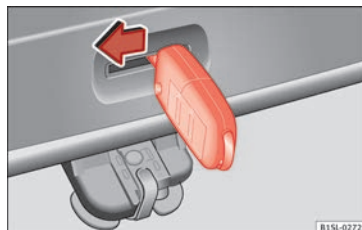

**Fig. 140** From the luggage compartment: Emergency unlocking of the booth hatch.

- If necessary, fold the rear seat bench backrest forward » **page 64**.
- Remove equipment to access the inside of the rear lid.
- Unfold the key shaft » **page 43**.
- Insert the key shaft into the rear lid opening » **Fig. 140** and press the release lever in the direction of the arrow to unlock the rear lid.

## Changing the windscreen wiper blades

### Changing windscreen wiper blades

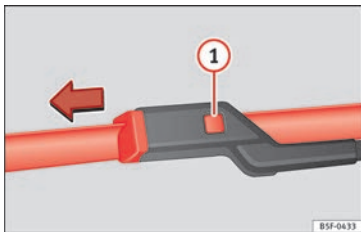

Fig. 141 Changing the front wiper blades

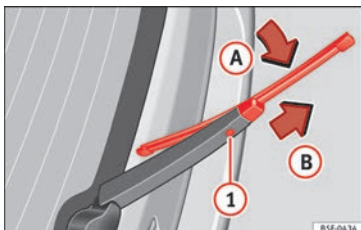

Fig. 142 Changing the rear wiper blade

The windscreen wiper blades are supplied as standard with a layer of graphite. This layer is responsible for ensuring that the wipe is silent. If the graphite layer is damaged, the

noise of the water as it is wiped across the windscreen will be louder.

Check the condition of the wiper blades regularly. **If the wipers scrape across the glass** they should be changed if they are damaged, or cleaned if they are dirty » ❶.

Damaged wiper blades should be replaced immediately. These are available from qualified workshops.

### Lifting and unfolding the wiper arms

The wiper arm may **only** be lifted at the point where it is fastened to the blade.

**For windscreen wipers, please note:** the wiper should be in service position before unfolding it » page 60.

### Cleaning windscreen wiper blades

- Lifting and unfolding the wiper arms.
- Use a soft cloth to remove dust and dirt from the windscreen wiper blades.
- If the blades are very dirty, a sponge or damp cloth may be used » ❶.

### Changing the windscreen wiper blades

- Lifting and unfolding the wiper arms.
- Hold down the release button » Fig. 141 ❶ while gently pulling the blade in the direction of the arrow.

- Fit a new wiper blade of the **same length and design** on to the wiper arm and hook it into place.
- Rest the wiper arms back onto the windscreen.

### Changing the rear wiper blade

- Lift the windscreen wiper arm and fold it at an angle of approximately 60° » Fig. 142.
- Press and hold the release button ❶.
- Fold the wiper blade towards the windscreen wiper arm » Fig. 142 (arrow A) while simultaneously pulling in the direction of arrow B). This may require some strength.
- Insert a new blade of the **same length and type** in the windscreen wiper arm in the opposite direction to the arrow B) and hook into place. This feature is operational when the knob is in position (arrow A).
- Return the windscreen wiper arm to the windscreen. Do not let it simply drop down!

### ⚠ WARNING

**Worn or dirty wiper blades reduce visibility and increase the risk of accident and serious injury.**

- **Always replace damaged or worn blades or blades which do not clean the windscreen correctly.**

**⚠ CAUTION**

- Damaged or dirty windscreen wipers could scratch the glass.
- If products containing solvents, rough sponges or sharp objects are used to clean the blades, the graphite layer will be damaged.
- Never use fuel, nail varnish remover, paint thinner or similar products to clean the windows.

**i Note**

If wax deposits, other cleaning products from the automatic car wash, or other care products, are left on the windscreen and the rear window, the blades can scratch the glass. Remove wax deposits with a special product or cleaning cloths.

## Fuses and bulbs

### Fuses

#### Introduction

Due to the constant updating of vehicles, fuse assignments based on equipment and the use of the same fuse for various electrical components, it is not possible to provide an up-to-date summary of the fuse positions for the electrical components at the time of printing this manual. For detailed information about the fuse positions, please consult a technical service.

In general, a fuse can be assigned to various electrical components. Likewise, an electrical component can be protected by several fuses.

Only replace fuses when the cause of the problem has been solved. If a newly inserted fuse blows after a short time, you must have the electrical system checked by a specialised workshop as soon as possible.

**⚠ WARNING**

The high voltages in the electrical system can give serious electrical shocks, causing burns and even death!

- Never touch the electrical wiring of the ignition system.

- Take care not to cause short circuits in the electrical system.

**⚠ WARNING**

Using unsuitable fuses, repairing fuses or bridging a current circuit without fuses can cause a fire and serious injury.

- Never use a fuse with a higher value. Only replace fuses with a fuse of the same amperage (same colour and markings) and size.
- Never repair a fuse.
- Never replace a fuse by a metal strip, staple or similar.

**⚠ CAUTION**

To prevent damage to the vehicle's electric system, before replacing a fuse always turn off the ignition, the lights and all electrical elements and remove the key from the ignition.

- If you replace a fuse with higher-rating fuse, you could cause damage to another part of the electrical system.
- Protect the fuse boxes when open to prevent the entry of dust or humidity as they can damage the electrical system.

**i Note**

One component may have more than one fuse.

**Note**

Several components may run on a single fuse.

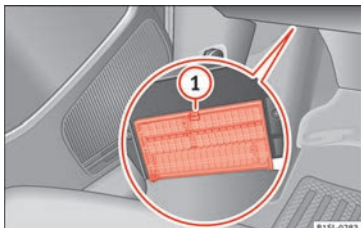
**Vehicle fuses**

**Fig. 143** Below the driver side dash panel: fuse box cover

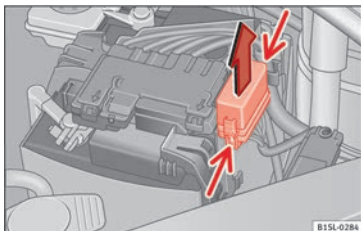

**Fig. 144** In the engine compartment: fuse box cover

Only replace fuses with a fuse of the same amperage (same colour and markings) and size.

**Identifying fuses situated below the driver-side dash panel by colours**

Colour	Amp rating
Purple	3
Light brown	5
Brown	7.5
Red	10
Blue	15
Yellow	20
White or transparent	25
Green	30
Orange	40

**Opening and closing the fuse box situated below the dash panel**

- **Opening:** Press the unlock button »» Fig. 143 ① until it is possible to open the cover. Fold the cover down.
- **Closing:** Fold the cover up in the opposite direction to the arrow until it clicks into the locking lever ①.

**To open the engine compartment fuse box**

- Open the bonnet »» page 143.
- Press the attachment tabs in the direction indicated by the arrow (thin arrows) to release the fuse box cover »» Fig. 144.
- Then lift the cover out.
- To **fit** the cover, place it on the fuse box. Push the attachment tabs down, in the opposite direction indicated by the arrow until they click audibly into place.

**CAUTION**

- Always carefully remove the fuse box covers and refit them correctly to avoid problems with your vehicle.
- Protect the fuse boxes when open to avoid the entry of dust or humidity. Dirt and humidity inside fuse boxes can cause damage to the electrical system.

**Note**

In the vehicle, there are more fuses than those indicated in this chapter. These should only be changed by a specialised workshop.

## Replacing a blown fuse

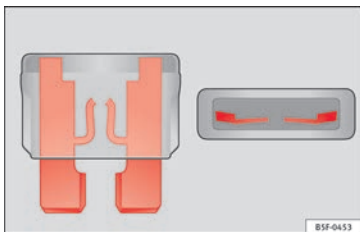

Fig. 145 Image of a blown fuse

### Preparation

- Switch off the ignition, lights and all electrical equipment.
- Open the corresponding fuse box  
»» page 190.

### Identifying a blown fuse

A fuse is blown if its metal strip is ruptured  
»» Fig. 145.

Point a lamp at the fuse. This will make it easier to see if the fuse is blown.

### To replace a fuse

- Remove the fuse.
- Replace the blown fuse by one with an *identical* amperage rating (same colour and markings) and *identical size* »» ❶.

- Replace the cover again or close the fuse box lid.

### ❶ CAUTION

If you replace a fuse with higher-rating fuse, you could cause damage to another part of the electrical system.

## Changing bulbs

### Introduction

Changing bulbs requires a certain amount of manual skill. If you are unsure, SEAT recommends that you consult a technical service or request assistance from a specialist. In general a specialist is needed if, in addition to the bulbs, other vehicle components require removal.

You should store spare light bulbs in the vehicle for safety-relevant lights. Spare bulbs may be obtained from the technical services. In some countries, it is a legal requirement to carry spare bulbs in the vehicle.

Driving with faults and blown bulbs on the vehicle exterior lighting is against the law.

### Additional bulb specifications

The specifications of some headlamp bulbs and bulbs for the tail lamps fitted at the factory may be different to those of conventional

bulbs. Bulb information is displayed on the bulb socket or on the bulb itself.

### ⚠ WARNING

If the road is not well-lit and the vehicle is not clearly visible to other drivers, there is a risk of accident.

### ⚠ WARNING

Failure to replace bulbs correctly may cause serious accidents.

- Before carrying out any work in the engine compartment please read and observe the warnings »» page 143. In any vehicle, the engine compartment is a hazardous area and could cause severe injury.
- The bulbs H4, HB4 and H7 are pressurised and might explode on changing them.
- Only replace the bulbs concerned when they have cooled.
- Never replace bulbs alone if you are not familiar with the operations necessary. If you are not sure about procedures then visit a specialised workshop to carry out the necessary work.
- Never touch the bulb glass directly. Fingerprints will be evaporated by the heat of the operating bulb thus “fogging” up the reflector.
- The headlamp frameworks in the engine compartment and the tail lamps contain sharp elements. Always protect your hands when changing bulbs.

## ⓘ CAUTION

- After changing a bulb, if the rubber covers are not replaced correctly on the headlamp framework, the electrical installation may be

damaged, especially if water is allowed to enter.

- Remove the ignition key before working on the electric system. Otherwise, a short circuit could occur.

- Switch off the lights and the parking light before changing a bulb.
- Take good care to avoid damaging any components.

## Replacing the bulbs in the headlights

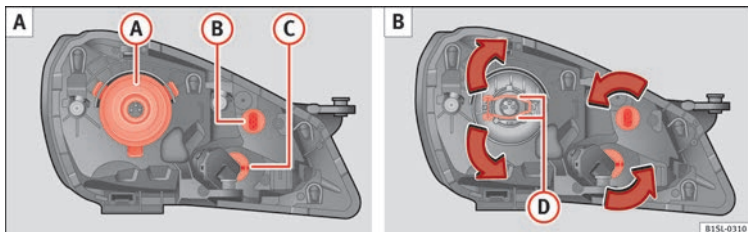

**Fig. 146** In the engine compartment: Rear view of the front left headlight with rubber cover: **A** dipped beam and main beam headlights, **B** side lights and daytime driving lights and **C** turn signal

There is no need to remove the headlight to replace bulbs.

Complete operations only in the sequence given:

Fig. 146	<b>A</b>	<b>B</b>	<b>C</b>
	Dipped beam and main beam headlights	Side light and daytime driving light	Turn signals (front)
1.	Open the bonnet  » page 143.		
2.	Remove the bulb connector H4. Remove the rubber cover using the tabs. Press the retaining clip <b>D</b> downwards in the direction of the arrow, and unclip sideways and remove it.	Turn the bulb holder <b>in an anticlockwise direction</b> as far as it will go and remove it, along with the bulb, pulling backwards.	

Complete operations only in the sequence given:

Fig. 146	A	B	C
	Dipped beam and main beam headlights	Side light and daytime driving light	Turn signals (front)
3.	Remove the bulb from the holder. If necessary, press the lock on the bulb holder.		
4.	Replace the faulty bulb by a new identical bulb.		
5.	Insert the bulb, return it to its position and insert the retaining clip <b>D</b>	Insert the bulb holder in the headlight and turn it <b>clockwise</b> as far as the stop.	Insert the bulb holder in the headlight and turn it <b>clockwise</b> as far as the stop.
6.	Place the rubber cover and check that it is in the correct position. Insert the connector to the bulb H4.		

### Note

The images show the left hand headlight from behind. The structure of the right hand side headlight is symmetric.

### To replace the front bumper bulbs

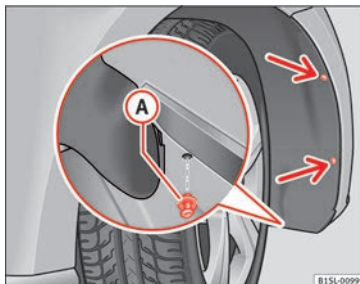

**Fig. 147** In the front right wheel arch: Remove the retaining screws (arrows) and take out the expansive rivet **A**.

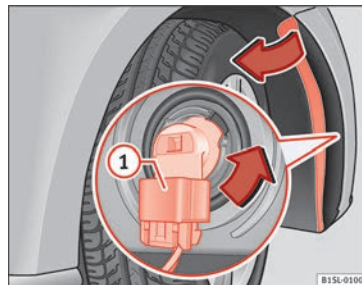
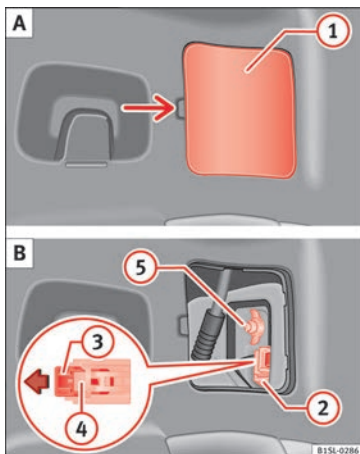

**Fig. 148** Changing the bulbs in the headlights

### Complete operations only in the sequence given:

1. Unscrew the 2 retaining screws of the wheel arch trim » Fig. 147 (arrows) with the screwdriver from the vehicle tool kit » page 172.
2. Unscrew the expansive rivet in the lower front part of the wheel arch trim (A) with the screwdriver from the vehicle tool kit and completely remove it » page 172.
3. Carefully fold the wheel arch trim to the side.
4. Release the connector » Fig. 148 (1) and remove it.
5. Turn the bulb holder » Fig. 148 in the direction of the arrow, **in an anticlockwise direction** as far as it will go and remove it, along with the bulb, pulling backwards.
6. Replace the faulty bulb by a new identical bulb.
7. Insert the bulb holder in the headlight and turn it **clockwise** as far as the stop.
8. Plug the connector (1) into the bulb holder. The connector must audibly click into place.
9. Replace the wheel arch trim into its position.
10. Place the expansive rivet in the wheel arch trim and bumper and press it completely inwards » Fig. 147 (A).
11. Securely screw the 2 retaining screws » Fig. 147 (arrows) with a screwdriver.

### Changing the bulbs in the rear lights



**Fig. 149** On the side of the luggage compartment: A: Remove the cover, B: Removing the tail light units

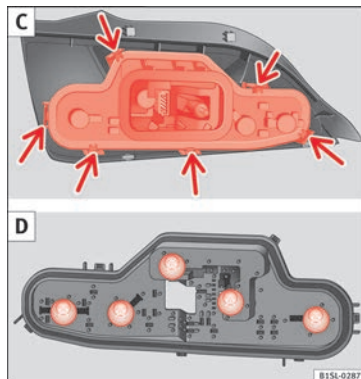

**Fig. 150** Tail light unit: C: Remove the bulb holder, D: Remove the bulbs.

Complete operations only in the sequence given.

### Removing the tail light units

1. Open the rear lid » page 50.
2. Carefully remove the cover (1) towards the lever » Fig. 149 A.
3. Pull the release (3) in the connector (2) in the direction of the arrow » Fig. 149 B. Use the screwdriver in the vehicle tool kit.
4. Press position (4) and remove the connector (2) » Fig. 149 B.

- Unscrew the wing nut (5) » Fig. 149 B.
- Remove the tail light from the bodywork by carefully pulling backwards.
- Disassemble the tail light unit and place it on a flat, clean surface.

### To change the bulb

- Unlock the bulb holder locking tab (arrow) » Fig. 150 C and remove the bulb holder from the tail light.
- Replace the faulty bulb by a new identical bulb » Fig. 150 D.
- Place the lamp holder in the tail light unit. The attachment tabs (arrow) should audibly click into place » Fig. 150 C.

### Assembling the tail light units

- Carefully insert the tail light unit into the opening in the bodywork.
- Support the tail light with one hand in the assembly position and securely screw the wing nut with the other (5) » Fig. 149 B.
- Ensure that the tail light unit has been correctly fitted and is firmly secured.
- Insert the connector (2) into the bulb holder and press the lock (3) on the connector in the opposite direction to the arrow » Fig. 149 B.
- Insert the cover. The cover should lock into place.
- Close the rear lid » page 50.

### Changing the number plate light

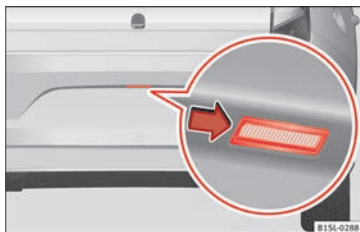

**Fig. 151** On the rear bumper: Remove the number plate light.



**Fig. 152** Number plate light: Remove the bulb holder.

### Complete operations only in the sequence given:

- With one hand, press on the number plate light from left to right and remove it from the bumper » Fig. 151.

### Complete operations only in the sequence given:

- Detach the number plate light carefully from the bumper.
- Turn the bulb holder with the bulb **anticlockwise** and remove it in the direction of the arrow » Fig. 152.
- Replace the faulty bulb by a new identical bulb.
- Place the bulb holder in the number plate light and press in the opposite direction to the arrow as far as possible » Fig. 152.
- Insert the number plate light carefully into the left edge of the opening on the bumper. During this process, check that the assembly direction of the number plate light is correct, i.e. the spring must be on the right.
- Insert the number plate light into the bumper until it audibly clicks into place.

## Changing the side turn signal bulb

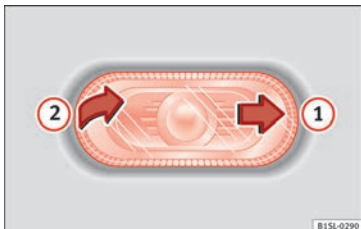

**Fig. 153** Removing the side turn signal

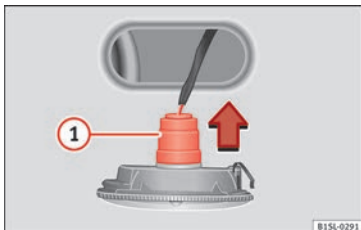

**Fig. 154** Side turn signal: Changing the bulbs.

### Complete operations only in the sequence given:

1. With one hand move the side turn signal backwards » **Fig. 153** (1).

### Complete operations only in the sequence given:

2. Remove the side turn signal from the chassis by leverage (2).
3. Remove the bulb holder with the bulb in the direction of the arrow » **Fig. 154** (1).
4. Remove the bulb holder bulb in a straight direction.
5. Replace the faulty bulb by a new identical bulb.
6. Install the lamp holder.
7. Place the side turn signal on the chassis on the side situated towards the rear of the vehicle until the spring clicks into the other side of the side turn signal.

## Technical specifications

### Technical features

### Important information

#### Introduction

The information in the vehicle documentation always takes precedence over the information in this Instruction Manual.

All technical specifications provided in this documentation are valid for the standard model in Spain. The vehicle data card included in the Maintenance Programme or the vehicle registration documents shows which engine is installed in the vehicle.

The figures may be different depending whether additional equipment is fitted, for different models, for special vehicles and for other countries.

#### Abbreviations used in the Technical Specifications section

Abbreviation	Meaning
kW	Kilowatt, engine power measurement.
PS	Pferdestärke (horsepower), formerly used to denote engine power.
rpm	Revolutions per minute - engine speed.
Nm	Newton metres, unit of engine torque.
litres per 100 km	Fuel consumption in litres per 100 km (70 miles).
g/km	Carbon dioxide emissions in grams per km (mile) travelled.
CO <sub>2</sub>	Carbon dioxide
CN	Cetane number, indication of the diesel combustion power.
RON	Research octane number, indication of the knock resistance of petrol.

#### Vehicle identification data

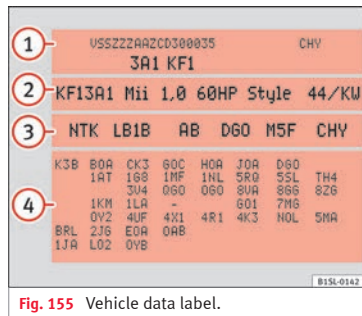

Fig. 155 Vehicle data label.



Fig. 156 Vehicle identification number.

#### Vehicle identification number

The vehicle identification number (chassis number) can be read from outside the vehicle through a viewer in the windscreen

» Fig. 156. This viewer is located in the lower »

part of the windscreen. The vehicle identification number (chassis number) is also stamped on the right water drain channel. The water drain channel is located between the suspension tower and the wing. Open the bonnet to read the vehicle identification number .

### Vehicle data plate

The vehicle data label  **Fig. 155** is at the front of the spare wheel well. It contains the following data:



- ① Vehicle identification number (chassis number).
- ② Vehicle type, engine power, gearbox type.
- ③ Engine and gearbox code, paint number, interior equipment.
- ④ Optional extras, PR numbers.

These data are also provided in the Maintenance Programme.

### Specific vehicle weight information

The instructions in the official vehicle documents take precedence. All the technical data provided in this documentation is applicable to the basic model. The vehicle data label in the Maintenance Programme or the vehicle documentation shows which engine is installed in your vehicle.

The figures may be different depending whether additional equipment is fitted, for different models and for special vehicles.

Kerb weight values shown in the following table apply to a vehicle with driver (75 kg), liquids including a fuel tank 90% full, in addition to tools and a spare wheel  . The kerb weight indicated increases with optional equipment and retrofitting of accessories, while proportionally reducing carrying capacity.

The load is equivalent to the following weights:

- Passengers.
- Total equipment.
- Roof load, included in the carrier.

### WARNING

**Exceeding the maximum authorised weight and the load on the axles could cause damage to the vehicle, accidents and serious injuries.**

- **The real load on the axles should never exceed the maximum permitted.**
- **The load and its distribution in the vehicle have effects on the vehicle handling and the braking ability. Always drive at a suitable speed.**

### CAUTION

**Distribute the load as uniformly and as low down on the vehicle as possible. When transporting heavy objects in the luggage compartment, these should be placed as far forward as possible or over the rear axle to have as little influence on handling as possible.**

### Information on fuel consumption

The consumption and emission values indicated do not refer to one specific vehicle. They are only to be used to compare the values of the different vehicle versions. The fuel consumption and CO<sub>2</sub> emissions of a vehicle not only depend on the effective use of fuel. They also depend on your driving style and other non-technical factors.

### Calculation of fuel consumption

Fuel consumption and emission values are determined according to the current version of the 715/2007/EC or 80/1268/EEC regulation and are valid for the vehicle kerb weight. The specifications do **not** refer to an individual vehicle. To measure the fuel consumption, two measuring cycles are carried out on a rolling road test bed. The test criteria are as follows:

Urban cycle	Measurement of the urban cycle starts with an engine cold start. City driving is then simulated at between 0 and 50 km/h (0 and 31 mph).
Road cycle	In the road cycle simulation, the car undergoes frequent acceleration and braking in all gears, as in normal everyday driving. The road speed ranges from 0 to 120 km/h (0 and 75 mph).
Combined	The average combined consumption is calculated with a weighting of around 37 % for the urban cycle and 63 % for the road cycle.
CO <sub>2</sub> emissions of the combination	The exhaust gases are collected during both driving cycles to calculate carbon dioxide emissions (urban and road). The gas composition is analysed below to evaluate the CO <sub>2</sub> content and other emissions.

**Note**

- The kerb weight may vary according to the vehicle equipment. This could raise consumption and the CO<sub>2</sub> emissions slightly.
- In practice, consumption values could be different to the values calculated based on the 715/2007/EC or 80/1268/EEC regulations.

## Wheels

### Tyre pressure, snow chains, wheel bolts

#### Tyre pressures

The sticker with the tyre pressure values can be found on the inside of the fuel tank flap. The tyre pressure values given there are for cold tyres. The slightly raised pressures of warm tyres must not be reduced. »» ⚠

#### Snow chains

Snow chains may be fitted only to the *front wheels*.

Consult the section “wheels” of this manual.

#### Wheel bolts

After the wheels have been changed, the **tightening torque** of the wheel bolts should be checked as soon as possible with a torque wrench »» ⚠. The tightening torque for steel and alloy wheels is **140 Nm**.

**⚠ WARNING**

- Check the tyre pressure at least once per month. Checking the tyre pressure is very important. If the tyre pressure is too high or too low, there is an increased danger of accidents - particularly at high speeds.

- If the tightening torque of the wheel bolts is too low, they could loosen while the vehicle is in motion. Risk of accident! If the tightening torque is too high, the wheel bolts and threads can be damaged.

**Note**

We recommend that you ask your Technical Service for information about appropriate wheel, tyre and snow chain size.

## Engine specifications

### Petrol engine 1.0 44 kW (60 PS)

#### Engine specifications

Power output in kW (PS) at rpm	Maximum torque (Nm at rpm)	No. of cylinders/displacement (cm <sup>3</sup> )	Fuel
44 (60)/5,000-6,000	95/3,000-4,300	3/999	Super 95 RON <sup>a)</sup>

<sup>a)</sup> Research Octane Number = Anti-detonation rating of the petrol.

Performance	Manual	Ecomotive	Automatic
Top speed (km/h)	160	161	160
Acceleration from 0-80 km/h (seconds)	9.1	9.1	9.4
Acceleration from 0-100 km/h (seconds)	14.4	14.4	15.3
<b>Consumption (l/100 km)/ CO<sub>2</sub> (g/km)</b>			
Urban cycle	5.6/130	5/116	5.3/123
Extra-urban cycle	3.9/91	3.6/84	3.9/91
Combined	4.5/105	4.1/95	4.4/103
<b>Weights (in kg)</b>			
Gross vehicle weight	1,290	1,290	1,290
Weight in running order (with driver)	929	940	932
Gross front axle weight	680	680	680
Gross rear axle weight	640	640	640
Permitted roof load	50	50	50

### Petrol engine 1.0 55 kW (75 PS)

#### Engine specifications

Power output in kW (PS) at rpm	Maximum torque (Nm at rpm)	No. of cylinders/displacement (cm <sup>3</sup> )	Fuel
55 (75)/6,200	95/3,000-4,300	3/999	Super 95 RON <sup>a)</sup>

<sup>a)</sup> Research Octane Number = Anti-detonation rating of the petrol.

Performance	Manual	Start-Stop	Automatic
Top speed (km/h)	171	172	171
Acceleration from 0-80 km/h (seconds)	8.3	8.3	9.2
Acceleration from 0-100 km/h (seconds)	13.2	13.2	13.9
<b>Consumption (l/100 km)/ CO<sub>2</sub> (g/km)</b>			
Urban cycle	5.9/137	5.1/118	5.5/127
Extra-urban cycle	4/93	3.7/86	4/94
Combined	4.7/108	4.2/98	4.5/105
<b>Weights (in kg)</b>			
Gross vehicle weight	1,290	1,290	1,290
Weight in running order (with driver)	929	940	932
Gross front axle weight	680	680	680
Gross rear axle weight	640	640	640
Permitted roof load	50	50	50

**Petrol/CNG engine 1.0 50 kW (68 PS)**
**Engine specifications**

Power output in kW (PS) at rpm	Maximum torque (Nm at rpm)	No. of cylinders/capacity (cm <sup>3</sup> )	Fuel
50 (68)/6,200	90/3,000	3/999	CNG / Super 95 RON <sup>a)</sup>

<sup>a)</sup> Research Octane Number = Anti-detonation rating of the petrol.

Performance	Petrol	CNG
Top speed (km/h)	164	
Acceleration from 0-80 km/h (seconds)	10.3	
Acceleration from 0-100 km/h (seconds)	16.3	
<b>Consumption (l/100 km) / CO<sub>2</sub> (g/km)</b>		
Urban cycle	5.5/99	3.6/99
Extra-urban cycle	3.8/68	2.5/68
Combined	4.4/79	2.9/79
<b>Weights (in kg)</b>		
Gross vehicle weight	1,370	
Weight in running order (with driver)	1,031	
Gross front axle weight	680	
Gross rear axle weight	640	
Permitted roof load	50	

### Dimensions

Longitude	3,557 mm
Width	1,641-1,645 mm
Height, unladen	1,478-1,489 mm
Wheelbase	2,420 mm
Turning circle diameter <sup>a)</sup>	approx. 9.8 m
Front track width <sup>a)</sup>	1,412-1,428 mm
Rear track width <sup>a)</sup>	1,408-1,424 mm
Ground clearance with maximum authorised load	109 mm

<sup>a)</sup> Depending on the dimensions of the wheel trims and tyres, there may be variations.

### ⓘ CAUTION

- **Special care should be taken when parking in areas with high kerbs or fixed barriers. Objects protruding from the ground may damage the bumper or other parts of the vehicle during manoeuvres.**
- **Special attention is required when driving through entrances, over ramps, kerbs or other objects. The vehicle underbody, bumpers, mudguards and running gear, and the engine and exhaust system could be damaged as you drive over these objects.**

### Capacities

	Fuel tank capacity
<b>Petrol engines</b>	Around 35.0 l , of which approximately 4.0 are the reserve.
<b>Natural gas engine</b>	Natural gas: approx. 11 kg; of which max. 1.5 kg reserve Petrol: approx. 10 l; of which approx. 5 l reserve



## Index

## A

- Abroad
  - Extended stay abroad with your vehicle ..... 135
  - Sale of vehicle ..... 135
- ABS
  - See "Brake assist systems" ..... 104
- Accessories ..... 118
- Additional equipment ..... 119
- Adjust
  - Headlight range ..... 58
- Adjustment
  - Correct sitting position ..... 6
  - Front seat ..... 63
  - rear head restraints ..... 9
  - Steering wheel ..... 7
- Aerial ..... 135
- Airbags
  - description ..... 19
- Airbag system ..... 17, 21
  - activation ..... 20
  - Cleaning dash panel ..... 133
  - Control lamp ..... 23
  - Deactivating the front passenger front airbag . 24
  - Deactivating using the key switch ..... 24
  - Differences between front passenger front airbag systems ..... 22
  - Faults ..... 120
  - Front airbags ..... 21
  - functioning ..... 20
  - Locking the vehicle after airbag deployment . 46
  - Repairs ..... 120
  - Side airbags ..... 22
  - Use of child seats ..... 24
  - Vehicle care ..... 133
- Air conditioner
  - Air recirculation ..... 84
  - Air vents ..... 83
  - Faults ..... 83
  - set ..... 82
  - Things to note ..... 83
  - User instructions ..... 82
- Air conditioning system ..... 80
  - Controls ..... 81
- Air recirculation ..... 84
  - How it works ..... 84
  - switch off ..... 84
  - temporarily switch off ..... 84
- Air vents ..... 83
- Alternator ..... 155
- Aluminium care ..... 129
- Anodized surfaces ..... 129
- Anti-lock brake system (ABS) ..... 104
- Anti-theft bolts ..... 173
- Anti-theft locking bolts ..... 174
- Anti-theft wheel locking bolts ..... 175
- Antifreeze ..... 150
- Ashtray ..... 71
- Aspects to take into account before starting the vehicle ..... 5
- ASR
  - see Brake assist systems ..... 104
- Assistance systems
  - Brake assist system (BAS) ..... 104
  - Cruise control system (CCS) ..... 107
  - Electronic differential lock system (EDL) ..... 104
  - Electronic stability control (ESC) ..... 103
  - Optical parking system (OPS) ..... 107
  - Parking aid ..... 106
  - Parking distance warning system ..... 106
  - Safety Assist (City Safety Assist function) .... 110
  - Start-Stop ..... 115
- Traction control system (ASR) ..... 104
- Traction Control (TC) ..... 104
- Assist systems
  - Anti-lock brake system (ABS) ..... 104
- Audible warnings
  - Control and warning lamps ..... 39
  - Lights ..... 56
  - Seat belt not fastened ..... 12
  - Speed ..... 42
- Automatic belt retainer ..... 16
- Automatic car wash ..... 126
- Automatic device disconnection ..... 157
- automatic gearbox ..... 93
- Automatic gearbox ..... 95
  - driving ..... 96
  - Ignition key removal lock ..... 87
  - Kickdown ..... 96
  - malfunction ..... 97
  - starting on a slope ..... 97
  - stopping on a slope ..... 97
- Axle loads ..... 198

## B

- BAS
  - see Brake assist systems ..... 104
- Battery
  - Change in the vehicle key ..... 44
  - Discharging ..... 172
  - drains ..... 45
  - See Vehicle battery ..... 154
- Battery acid ..... 156
- Before starting the vehicle ..... 5
- Belt tensioner ..... 16
  - Disposal ..... 17
  - Service and disposal ..... 17
- Belt tension limiter ..... 16
- Bench ..... 74

- Bonnet  
 Closing ..... 145  
 Opening ..... 145
- Boot variable floor  
 extend below ..... 76  
 extend forwards ..... 76
- Brake  
 Brake servo ..... 92  
 Brake assist systems ..... 103  
 Brake assist system (BAS) ..... 104  
 Brake fluid ..... 152  
 Specification ..... 153  
 Brakes ..... 89  
 Brake assist systems ..... 103  
 Brake fluid ..... 152  
 Brake fluid level ..... 153  
 Brake pads ..... 91  
 Changing the brake fluid ..... 153  
 Control lamp ..... 89  
 Emergency brake indicator in case of sudden  
 braking ..... 172  
 Handbrake ..... 90  
 Running-in brake pads ..... 91  
 Warning lamp ..... 89  
 Brake servo ..... 92, 103  
 Brake system  
 Malfunction ..... 92  
 Brake systems ..... 103  
 Breakdown  
 Securing the vehicle ..... 171  
 Bulb fault  
 See changing bulbs ..... 191
- C**
- Capacities  
 Fuel tank ..... 203
- Care  
 See "Care of your vehicle" ..... 125  
 Vehicle interior ..... 131  
 Care of your vehicle  
 Exterior ..... 125  
 Caring for paintwork ..... 129  
 Carrier system ..... 77  
 Catalytic converter ..... 102  
 Control lamp ..... 101  
 Malfunctions ..... 102  
 CCS ..... 107  
 Central locking ..... 45  
 Central locking button ..... 48  
 locking and unlocking from the exterior ..... 46  
 locking and unlocking from the inside ..... 48  
 Central locking system  
 After airbag deployment ..... 46  
 Description ..... 46  
 Opening doors individually ..... 46  
 Changing  
 Windscreen wiper blades ..... 188  
 Changing a wheel ..... 174  
 Changing a wheel ..... 178  
 Raising the vehicle ..... 177  
 Wheel bolts ..... 175  
 Changing bulbs ..... 191  
 Front bumper ..... 193  
 in the headlights ..... 192  
 Number plate light ..... 195  
 Rear lights ..... 194  
 Sea changing bulbs ..... 191  
 Changing gear ..... 93  
 Automatic gearbox ..... 95  
 Engaging gears (automatic gearbox) ..... 95  
 Engaging gears (manual gearbox) ..... 94  
 Manual gearbox ..... 94  
 Warning and control lamps ..... 93  
 with Tiptronic ..... 96  
 Changing gears  
 Gear recommendation ..... 98  
 Changing the bulbs  
 Side turn signal ..... 196  
 Changing the wheel  
 After changing the wheel ..... 178  
 Chassis number ..... 197  
 Checking  
 Tyre pressures ..... 162  
 Checking the oil level ..... 148  
 Child safety ..... 25  
 Child safety seat  
 Securing with seat belt ..... 30  
 Child seat ..... 25  
 Fix with ISOFIX ..... 31  
 ISOFIX child seat on rear seats ..... 29  
 Mounting child seats ..... 28  
 Mounting systems ..... 28  
 On rear seats ..... 29  
 On the front passenger seat ..... 28  
 Regulations ..... 27  
 Securing using a Top Tether retaining strap ..... 32  
 Transporting children in the vehicle ..... 27  
 Weight categories ..... 27  
 Child seats  
 Disabling the front passenger front airbag ..... 24  
 Chromework care ..... 129  
 Cigarette lighter ..... 72  
 City Safety Assist function ..... 110  
 Control lamp ..... 111  
 Function ..... 113  
 Sensor ..... 112  
 Special driving situations ..... 113  
 Warning lamp ..... 111

## Index

- Cleaning
    - dash panel ..... 133
    - Engine compartment ..... 131
    - Seat belts ..... 134
    - See "Care of your vehicle" ..... 125
    - wheels ..... 130
    - Windscreen wiper blades ..... 188
  - Lock ..... 36
  - Closing
    - Doors ..... 49
    - from the exterior ..... 46
    - from the inside ..... 48
    - Rear lid ..... 51
    - Sliding/tilting electric panoramic sunroof ..... 53
    - windows ..... 52
  - Coat hooks ..... 70
  - Cockpit ..... 35
  - Code number ..... 173
  - Collection of end-of-life vehicles ..... 136
  - Compartments
    - boot variable floor ..... 76
    - Centre console ..... 68
    - Glove compartment ..... 68, 69
    - Other storage compartments ..... 70
    - Passenger side ..... 68, 69
    - Sunglasses storage compartment ..... 68
  - Components ..... 118
  - Conformity certification ..... 136
  - Consumption
    - How it is determined ..... 198
    - Information ..... 198
  - control lamp
    - on the driver door ..... 49
    - Vehicle key ..... 44
  - Control lamp
    - Airbag system ..... 23
    - Brake pad wear warning ..... 89
  - Brake system ..... 89
  - Catalytic converter ..... 101
  - Checking the engine oil level ..... 147
  - City Safety Assist function ..... 111
  - Cruise control system (CCS) ..... 108
  - Emission control system ..... 101
  - Engine coolant ..... 150
  - Engine management ..... 101
  - Engine oil sensor ..... 147
  - ESC ..... 89
  - Fuel level ..... 140
  - Hill hold ..... 115
  - Overview ..... 39
  - Steering column lock ..... 85
  - Control lamps
    - Lights ..... 55
  - Controlling function
    - Electric exterior mirrors ..... 63
  - Control units ..... 121
  - Reprogramming ..... 121
  - Convenience functions
    - Reprogramming ..... 121
  - Coolant
    - See engine coolant ..... 150
  - Correct sitting position for vehicle occupants ..... 6
  - Crossing a river
    - Salt water ..... 103
  - Cruise control system ..... 107
  - Cruise control system (CCS)
    - Control lamp ..... 108
    - Operations ..... 109
  - Curb weight ..... 198
- D**
- Damaged tyres ..... 163
  - Dangers in not using the seat belt ..... 14
  - Dash panel ..... 35
  - Airbag system ..... 21, 133
  - Data link connector (DLC) ..... 122
  - Data registry ..... 121
  - Data storage during the journey ..... 121
  - Data stored by the control units ..... 121
  - Daytime driving light ..... 57
  - De-icing the door lock cylinder ..... 130
  - De-icing the locks ..... 130
  - Deadlock
    - "Safe" security system ..... 48
  - Device disconnection ..... 157
  - Diagnostics connection ..... 122
  - Differential lock
    - See "Brake assist systems" ..... 104
  - Digital clock ..... 36
  - Dimensions ..... 203
  - Dipped beam headlights ..... 56
  - Dipstick ..... 148
  - Display ..... 37
  - Instrument panel ..... 37
  - Disposal
    - Airbag system ..... 136
    - Belt tensioner ..... 17
    - End-of-life vehicle ..... 136
  - Door release lever
    - interior ..... 35
  - Doors ..... 49
  - Childproof locks ..... 50
  - Emergency locking and unlocking ..... 186
  - Drink holders ..... 70
  - Centre console ..... 71
  - Drinks bottles
    - see Drink holders ..... 70
  - Driving
    - Data storage ..... 121
    - Driving abroad ..... 102

- Driving through water ..... 103  
 Driving with an automatic gearbox ..... 96  
 Ecological ..... 99  
 Economical ..... 99  
 Fuel gauge ..... 140  
 Fuel level too low ..... 141  
 Parking downhill ..... 91  
 Parking uphill ..... 91  
 starting on a slope ..... 97  
 stopping on a slope ..... 97  
 Tips ..... 5  
 Towing ..... 185
- Driving abroad**  
 Headlights ..... 58
- Driving advice**  
 Spare wheel ..... 165  
 Temporary spare wheel ..... 165
- Driving in winter**  
 Fuel consumption ..... 101  
 Snow chains ..... 169  
 Tread depth ..... 163  
 Tyre pressure ..... 162  
 Windscreen washer bottle ..... 129
- Driving safety ..... 5
- Driving through water ..... 103
- Driving tips  
   For a loaded vehicle ..... 65
- Dust filter ..... 80
- E**  
 Ecological driving ..... 99  
 Economical driving ..... 99  
 EDL  
   See "Brake assist systems" ..... 104  
 electrical devices ..... 72  
 Electrical devices ..... 73, 172
- Electric windows  
   Buttons ..... 52  
   Closing ..... 52  
   Opening ..... 52  
   see Windows ..... 52
- Electronic differential lock system (EDL) ..... 104  
 Electronic immobiliser ..... 88  
 Electronic stability control (ESC) ..... 103  
 Emergency brake indicator ..... 172  
 Emergency locking and unlocking ..... 186  
   Driver door ..... 186  
   Passenger door ..... 187  
   Rear lid ..... 187
- Emission control system  
   Control lamp ..... 101
- Engaging gears  
   Automatic gearbox ..... 95  
   Manual gearbox ..... 94
- Engine  
   Noises ..... 88  
   Running-in ..... 98  
 Engine and ignition ..... 86  
   12 Volt sockets ..... 73  
   Ignition lock ..... 86  
   Immobiliser ..... 88  
   Starting the engine ..... 87  
   Stopping the engine ..... 88  
   Unauthorised vehicle key ..... 86  
 Engine compartment ..... 143  
   Engine coolant ..... 150  
   Engine oil ..... 146  
   Vehicle battery ..... 154  
   Water box ..... 131  
 Engine coolant ..... 150  
   Checking the level ..... 151  
   Filler neck ..... 151  
   G 12 plus-plus ..... 150
- G 13 ..... 150  
 Refilling ..... 151  
 Specifications ..... 150  
 Temperature gauge ..... 150  
 Warning lamp ..... 150
- Engine management ..... 101  
   Control lamp ..... 101
- Engine oil ..... 146  
   changing ..... 149  
   Checking the oil level ..... 148  
   Consumption ..... 149  
   Control lamp ..... 147  
   Dipstick ..... 148  
   Filler neck ..... 148  
   Specifications ..... 147  
   Topping up ..... 148  
   Warning lamp ..... 147
- Environment  
   Environmental friendliness ..... 99
- ESC ..... 103
- Event Data Recorder ..... 121
- Exhaust gas purification system ..... 101
- Exterior aerial ..... 120
- Exterior mirrors ..... 62  
   Controlling function ..... 63  
   folding ..... 62  
   Vehicle care ..... 128
- F**  
 Fastening  
   seat belts ..... 15
- Fault  
   Parking distance warning system ..... 106
- Fault memory  
   Connector ..... 122
- Faults  
   Air conditioner ..... 83

- Filling the tank ..... 139  
 At the filling station ..... 137
- Fire extinguisher ..... 171
- First-aid kit  
 Storage ..... 170
- First aid kit ..... 170  
 see First aid kit ..... 170
- Floor mats ..... 10
- Fluids ..... 118
- Fog lights ..... 56
- Front airbags  
 See "Airbag system" ..... 21
- Front passenger airbag  
 See "Airbag system" ..... 21
- Front passenger front airbag  
 Deactivating using the key switch ..... 24
- Fuel ..... 137  
 Information on consumption ..... 198  
 Petrol ..... 137  
 Type of fuel ..... 137
- Fuel consumption  
 Economical driving ..... 99  
 ¿Why does it increase? ..... 102
- Fuel gauge ..... 140  
 Control lamp ..... 140  
 Fuel ..... 140  
 Refuelling ..... 140
- Fuel tank flap  
 close ..... 142  
 open ..... 142  
 Petrol ..... 142
- Fuses ..... 189  
 Fuse box ..... 190  
 Identifying blown fuses ..... 191  
 Identifying by colours ..... 190  
 Preparation before replacing ..... 191  
 Replacement ..... 191
- G**
- Glove compartment  
 see Compartments ..... 68, 69
- H**
- Handbrake ..... 90
- Hazard warning lights ..... 171
- Head-on collisions and the laws of physics ..... 14
- Headlamp range adjustment ..... 35
- Headlight range control ..... 58
- Headlights  
 Driving abroad ..... 58  
 Headlight washers ..... 61  
 Heated rear window ..... 82  
 Heated seats ..... 64
- Heating and ventilation system  
 Controls ..... 81  
 See also Air conditioning system ..... 80
- High pressure cleaning apparatus ..... 127
- Hill driving assistant ..... 114
- Hill hold  
 Control lamp ..... 115  
 Start-Stop system ..... 115  
 Warning lamp ..... 115
- Horn ..... 35
- I**
- Identification number ..... 197
- Identification plate ..... 197
- Ignition  
 See "Engine and ignition" ..... 86
- Ignition key  
 see vehicle key ..... 43, 44
- Ignition lock ..... 86  
 Key removal lock ..... 87  
 Unauthorised vehicle key ..... 86
- Immobiliser ..... 88
- Immobilizer  
 Operating fault ..... 86
- In case of a breakdown  
 Securing the vehicle ..... 171
- In case of an emergency  
 Hazard warning lights ..... 171  
 In case of a breakdown ..... 171  
 Protecting yourself and securing the vehicle ..... 171
- In case of emergency ..... 170
- Information on consumption ..... 198
- InSP Indicator ..... 38
- Instrument panel  
 Display ..... 37  
 Display control functions ..... 41  
 Instruments ..... 36  
 Lighting ..... 58  
 Screen ..... 36  
 Service interval display ..... 38  
 Symbols ..... 39  
 Warning lamp ..... 39  
 Warning lamps ..... 39
- Instruments ..... 36
- In the event of an emergency  
 Fire extinguishers ..... 170  
 First aid kit ..... 170  
 Warning triangle ..... 170
- ISOFIX ..... 31  
 see Child seat ..... 25
- J**
- Jack ..... 174  
 Raising the vehicle ..... 177
- K**
- key  
 see vehicle key ..... 44

- Key
  - see vehicle key ..... 43
- Key switch
  - Deactivating the front passenger front airbag . 24
- Kickdown ..... 96
- L**
- Labels ..... 135
- Lifting platform ..... 125
- Lights ..... 55
  - Audible warnings ..... 56
  - Control lamps ..... 55
  - Controls lighting ..... 58
  - Daytime driving light ..... 57
  - Dipped beam headlights ..... 56
  - Fog lights ..... 56
  - Functions ..... 57
  - Headlight range control ..... 58
  - Instrument panel lighting ..... 58
  - Instruments lighting ..... 58
  - Light switch ..... 56
  - Main beam lever ..... 57
  - Parking light remains on both sides ..... 57
  - Reading light ..... 58
  - Side lights ..... 56
    - turning off ..... 56
    - turning on ..... 56
  - Turn signal lever ..... 57
- Load
  - Driving with the rear lid open ..... 66
  - Transporting a load ..... 66
- Loading ..... 73
  - General advice ..... 65
  - Loading luggage compartment ..... 73
  - Roof carrier system ..... 79
- Locking
  - from the exterior ..... 46
  - from the inside ..... 48
  - Rear lid ..... 51
- Luggage compartment
  - Rear shelf ..... 75
- M**
- Main beam headlights ..... 56
- Main beam lever ..... 57
- Main panel
  - Turn signal and main beam lever ..... 57
- Malfunction
  - automatic gearbox ..... 97
  - Catalytic converter ..... 102
- Manual gearbox ..... 93
  - see also Changing gear ..... 93
- Manufacturer identification plate ..... 197
- mechanical locking
  - locking and unlocking from the exterior ..... 46
  - locking and unlocking from the inside ..... 48
- Mirrors
  - Convenience functions ..... 62
  - Exterior mirrors ..... 62
  - Rear vision mirror ..... 61
- Mobile telephone
  - Using without an exterior aerial ..... 122
- Modifications ..... 119, 135
- Modifications to the vehicle ..... 118
  - Labels ..... 135
  - Plates ..... 135
- N**
- Natural gas ..... 138
  - Fuel ..... 138
  - refuelling ..... 142
  - Types ..... 138
- New engine ..... 98
- New tyres ..... 161
- New tyres and wheels
  - About your tyres and wheels ..... 159
- Noises
  - Brake assist systems ..... 105
  - Engine ..... 88
- Notes for the user ..... 134
- Number of seats ..... 8
- O**
- Octane rating ..... 137
- Odometer ..... 36
- Oil
  - See engine oil ..... 146
- Older tyres ..... 160
- Onboard diagnostic system (ODB) ..... 122
- Opening
  - Doors ..... 49
    - from the exterior ..... 46
    - from the inside ..... 48
    - Rear lid ..... 51
    - Sliding/tilting electric panoramic sunroof ..... 53
    - windows ..... 52
  - Opening doors individually ..... 46
- Operating fault
  - Immobilizer ..... 86
- Operating faults
  - Radio reception ..... 73, 135
- Optical parking system (OPS) ..... 107
- Outside temperature indicator ..... 37
- Overview
  - Control lamps ..... 39
    - dash panel ..... 35
    - Instruments ..... 36
    - Warning lamps ..... 39
- P**
- Parking ..... 89, 91

- Parking aid ..... 106  
 Parking distance warning system  
   Fault ..... 106  
   Optical parking system (OPS) ..... 107  
   Using high pressure cleaning apparatus ..... 127  
 Parking light ..... 57  
 Parking light remains ..... 57  
 Parking sensor system ..... 105  
 ParkPilot ..... 106  
 Pedals ..... 6, 10  
 Petrol ..... 137  
   Additives ..... 137  
   Fuel ..... 137  
   Fuel gauge ..... 140  
   Refuelling ..... 142  
   Types ..... 137  
 Plates ..... 135  
 Polishing ..... 129  
 Pollen filter ..... 80  
 Pollution filter ..... 80  
 Portable Navigation System ..... 123  
 Positioning seat belts ..... 15  
 Power socket  
   12 volts ..... 72  
 Preparation  
   Checking the engine coolant level ..... 151  
   Vehicle battery ..... 156  
 Preparations  
   Checking the engine oil level ..... 148  
   Topping up the engine oil level ..... 148  
 Protection of vehicle undercarriage ..... 130  
 Pushing ..... 86
- R**
- Radar sensor ..... 112  
 Radio reception  
   Aerial ..... 135  
   Operating faults ..... 73, 135  
 Raising the vehicle  
   Jack ..... 177  
 Raising vehicle  
   Lifting platform ..... 125  
   With a lifting platform ..... 125  
 Reading light ..... 58  
 Reading the  
   Fault memory ..... 122  
 Rear backrest  
   Folding ..... 74  
   Lifting up ..... 74  
 Rear head restraints  
   Adjustment ..... 9  
   removing and fitting ..... 64  
 Rear lid ..... 50  
   Closing ..... 51  
   Driving with the rear lid open ..... 66  
   Emergency locking and unlocking ..... 187  
   Opening ..... 51  
   see rear lid ..... 46  
   See "Rear lid" ..... 50  
   Unlocking ..... 51  
   unlocking and locking ..... 46  
 Rear seat bench ..... 74  
 Rear vision mirror ..... 61  
 Rear vision mirrors ..... 61  
 Rear window wiper ..... 60  
 Recommended gear ..... 98  
 Recycling ..... 136  
 Refuelling  
   Control lamp ..... 140  
   Fuel ..... 142  
   Fuel gauge ..... 140  
   Mistakes ..... 139  
   Natural gas ..... 142  
   Petrol ..... 142  
 Remote control key  
   see vehicle key ..... 43  
 Removing ice ..... 129  
 Removing snow ..... 129  
 Removing wax deposits ..... 128  
 Repairs ..... 119  
   Airbag system ..... 120  
   Labels ..... 135  
   Lifting platform ..... 125  
   Plates ..... 135  
 Replacement of parts ..... 118  
 Reprogramming control units ..... 121  
 Reservoir capacity  
   Windscreen washer water reservoir ..... 154  
 Retaining hooks ..... 77  
 Retro-fitting  
   Two-way radios ..... 120  
   Vehicle telephone ..... 120  
 Rev counter ..... 36  
 Roof carrier system ..... 77  
 Rubber seals ..... 130  
 Running-in  
   Brake pads ..... 91  
   First trips ..... 98  
   Running-in brake pads  
     Please also see "Brakes" ..... 91  
 Running in  
   Engine ..... 98  
   Tyres ..... 161  
   Wheels and tyres ..... 161
- S**
- Safe driving ..... 5  
 Safety ..... 5  
 Safety Assist ..... 110

- Safety equipment ..... 6, 19
- SAFE (immobilizer) ..... 88
- Sale of vehicle
  - In other countries / continents ..... 135
- Salt water ..... 103
- Scrapping ..... 136
- Screen ..... 36
- Seat adjuster ..... 6
- Seat belt protection ..... 13
- Seat belts ..... 11
  - Automatic belt retainer ..... 16
  - Belt tensioner ..... 16
  - Belt tension limiter ..... 16
  - Positioning seat belts ..... 15
  - Seat belt status display ..... 12
  - Twisted belt ..... 13
    - unfastened ..... 14
  - Use ..... 13
  - Warning lamp ..... 12
- Seat belt tensioners ..... 16
- Seat belt warning lamp ..... 12
- Seat functions ..... 64
- Seat heating ..... 64
- SEAT information system ..... 40
- Seats ..... 8
  - Adjusting the steering wheel position ..... 7
  - Adjust the rear head restraints ..... 9
  - Correct position ..... 6
  - Fitting the rear head restraints ..... 64
  - Front seat ..... 63
  - Heated seats ..... 64
  - Number of seats ..... 8
  - Rear backrest ..... 74
  - Removing and fitting rear head restraints ..... 64
- Service interval display ..... 38
- Set
  - Air conditioner ..... 82
  - Side airbags
    - See "Airbag system" ..... 22
  - Side lights ..... 56
  - Sitting position
    - Incorrect position ..... 8
  - Sliding/tilting electric panoramic sunroof ..... 53
    - Anti-trap function ..... 54
    - Close ..... 54
    - Open ..... 54
  - Small window ..... 59
  - Snow chains ..... 169, 199
    - Temporary spare wheel ..... 170
  - Spare fuel canister ..... 139
  - Spare key
    - see vehicle key ..... 43, 44
  - Spare parts ..... 118
  - Spare wheel ..... 165
    - Driving advice ..... 165
    - removing ..... 165
  - Special features
    - Automatic car wash ..... 127
    - High pressure cleaning equipment ..... 128
    - Parking ..... 89, 91, 203
    - Pushing ..... 86
    - Radio reception ..... 135
    - Towing ..... 86
    - Washing the vehicle ..... 127
    - Windscreen wipers ..... 61
  - Special notes
    - Towing ..... 183, 184
    - Tow starting ..... 184
  - Speed rating ..... 169
  - Start-Stop ..... 115
  - Start-Stop system ..... 115
  - Start-up Assistant ..... 115
  - Starting assistance ..... 181
    - Description ..... 182
    - Jump leads ..... 182
  - Starting using an external battery
    - See Starting assistance ..... 181
  - Steering ..... 84
    - Control lamp ..... 85
    - Electromechanical ..... 85
    - Power steering ..... 85
    - Steering column lock ..... 85
    - Tendency to pull to one side ..... 163
    - Warning lamp ..... 85
  - Steering wheel
    - Adjustment ..... 7
  - Storage compartment
    - Centre console ..... 70
    - Driver side ..... 68
  - Storage compartments ..... 67
  - Sudden braking ..... 172
  - Sunglasses storage compartment ..... 68
  - Sun protection ..... 59
  - Sun visor ..... 59
  - Symbols
    - see warning lamp ..... 39
  - Systems
    - ABS ..... 104
    - Anti-lock brake system (ABS) ..... 104
    - ASR ..... 104
    - BAS ..... 104
    - Brake assist system (BAS) ..... 104
    - Cruise control system (CCS) ..... 107
    - EDL ..... 104
    - Electronic differential lock system (EDL) ..... 104
    - Electronic stability control (ESC) ..... 103
    - ESC ..... 103
    - Optical parking system (OPS) ..... 107
    - Parking aid ..... 106

- Parking distance warning system ..... 106  
 Safety Assist (City Safety Assist function) ..... 110  
 Start-Stop ..... 115  
 TC ..... 104  
 Traction control system (ASR) ..... 104  
 Traction Control (TC) ..... 104
- T**
- Tank flap  
   close ..... 142  
   Natural gas ..... 142  
   open ..... 142
- TC  
   see Brake assist systems ..... 104
- Technical data  
   Axle loads ..... 198  
   Capacities ..... 203  
   Curb weight ..... 198  
   Engine oil specifications ..... 147  
   Identification plate ..... 197  
   Manufacturer identification plate ..... 197  
   Reservoir capacity ..... 154  
   Roof load ..... 79  
   Total weight ..... 198  
   Tyre pressures ..... 162  
   Vehicle data label ..... 197  
   Weights ..... 198
- Technical features ..... 197
- Technical information  
   Type of fuel ..... 137
- Technical modifications ..... 119
- Labels ..... 135
- Lifting platform ..... 125
- Plates ..... 135
- Technical specifications  
   Dimensions ..... 203
- Temperature display  
   Liquid coolant temperature ..... 41  
   Outside temperature ..... 37
- Temporary spare wheel ..... 165
- Driving advice ..... 165
- Snow chains ..... 170
- Things to note  
   Disconnecting the vehicle's battery ..... 38  
   Long parking times ..... 45  
   parking distance warning system ..... 106  
   Removing the vehicle key ..... 87  
   Water underneath the vehicle ..... 83
- Tightening torque  
   Wheel bolts ..... 176
- Tightening torque of wheel bolts ..... 199
- TIN ..... 168
- Tips for driving ..... 5
- Before starting out ..... 5
- Tiptronic ..... 96
- Tyre Mobility Set  
   Check after 10 minutes ..... 181  
   Do not use ..... 178  
   Inflating a tyre ..... 180  
   Sealing a tyre ..... 180
- Tools  
   See Vehicle tool kit ..... 172
- Total weight ..... 198
- Towing ..... 86, 183
- Driving tips ..... 185
- Front towline anchorage ..... 185
- Special notes ..... 183, 184
- Tow bar ..... 184
- Tow rope ..... 184
- Tow starting ..... 184
- Traction ..... 169
- Traction control system (ASR) ..... 104
- Traction Control (TC) ..... 104
- Trailer coupling  
   Towing bracket ..... 117
- Transporting  
   Transporting a load ..... 66  
   Transporting a load ..... 66  
   Transporting children in the vehicle ..... 27  
   Transporting objects  
     Driving tips ..... 67  
     Driving with the rear lid open ..... 66  
     Retaining hooks ..... 77  
     Roof carrier system ..... 77, 79  
   Tread depth ..... 163  
   Treadwear ..... 169  
   Trip meter ..... 36  
   Turn signal convenience function ..... 57  
   Turn signal lever ..... 57  
   Two-way radios ..... 120  
   Type of fuel ..... 137  
   Tyre load rating ..... 169  
   Tyre mobility set  
     Components ..... 179  
   Tyre mobility system ..... 178  
   Tyre Mobility System  
     See tyre mobility system ..... 178  
   Tyre monitoring lamp ..... 164  
   Tyre pressure  
     Spare wheel ..... 162  
     Temporary spare wheel ..... 162  
   Tyre pressures ..... 162, 199  
   Tyre repair set  
     See tyre mobility system ..... 178  
   Tyres with directional tread pattern ..... 169
- U**
- Unfastening  
   seat belts ..... 15

- Unlocking
  - from the inside ..... 48
- Upholstery ..... 131
  - Fabric trim cleaning ..... 132
  - Padding cleaning ..... 132
  - Treating your upholstery ..... 132
- V**
- Valve caps ..... 163
- Vehicle
  - Collection ..... 136
  - Loading ..... 65
  - locking and unlocking from the exterior ..... 46
  - locking or unlocking from the inside ..... 48
  - Parking downhill ..... 91
  - Parking uphill ..... 91
  - Recycling ..... 136
  - Securing in case of a breakdown ..... 171
- Vehicle battery ..... 154
  - Acid ..... 156
  - Automatic device disconnection ..... 157
  - Checking the electrolyte level ..... 156
  - Discharging ..... 87
  - Explanation of symbols ..... 154
  - Location ..... 154
  - Preparation ..... 156
  - Starting assistance ..... 182
  - Warning lamp ..... 155
- Vehicle care
  - Aerial built into the window ..... 135
  - Airbag modules (dash panel) ..... 133
  - Aluminium wheel rims ..... 129
  - anodized surfaces ..... 129
  - Automatic car wash ..... 126
  - Changing windscreen wiper blades ..... 188
  - Chrome wheel rims ..... 129
  - Cleaning compartments ..... 133
  - Cleaning seat belts ..... 134
  - Cleaning wheels ..... 130
  - Cleaning windscreen wiper blades ..... 188
  - Dash panel ..... 133
  - De-icing the door lock cylinder ..... 130
  - Engine compartment ..... 131
  - Exterior mirrors ..... 128
  - Fabric trim ..... 132
  - High pressure cleaning apparatus ..... 127
  - Padding ..... 132
  - Plastic parts ..... 133
  - Protection of vehicle undercarriage ..... 130
  - Rubber seals ..... 130
  - Special features ..... 127, 128
  - Treating your upholstery ..... 132
  - Vehicle paintwork ..... 129
  - Washing by hand ..... 126
  - Washing the vehicle ..... 126
  - Windows ..... 128
  - Windscreen wipers service position ..... 61
  - Wooden trim ..... 133
- Vehicle code
  - Vehicle data label ..... 198
- Vehicle data label ..... 197
- Vehicle identification data ..... 197
- Vehicle identification number ..... 197
- Vehicle key
  - assign ..... 43, 44
  - Changing the battery ..... 44
  - control lamp ..... 44
  - Synchronising ..... 45
- Vehicle key set ..... 43
- Vehicle mechanical key ..... 44
- Vehicle telephone ..... 120
- Vehicle tool kit ..... 172
  - Components ..... 173
  - Location ..... 172
- Vehicle's battery
  - Charging ..... 156
  - Connecting ..... 156
  - Disconnecting ..... 156
  - Replacing ..... 156
  - Running flat ..... 157
- Vibrations
  - Steering ..... 163
- W**
- Warning and control lamps
  - Changing gear ..... 93
- Warning lamp
  - Alternator ..... 155
  - Brake system ..... 89
  - City Safety Assist function ..... 111
  - Engine coolant ..... 150
  - Engine oil pressure ..... 147
  - Hill hold ..... 115
  - Overview ..... 39
  - Seat belts ..... 12
  - Vehicle battery ..... 155
  - Warning triangle ..... 170
- Washing ..... 125
  - by hand ..... 126
  - with high pressure cleaning apparatus ..... 127
- Washing the vehicle ..... 126
  - Sensors ..... 106
  - Special features ..... 127
- Water box ..... 131
- Wear indicators ..... 163
- Wear of tyres ..... 164
- Weights ..... 198
- Wheel bolts ..... 174, 175, 199
  - Caps ..... 175
  - Tightening torque ..... 176
- Wheel load capacity ..... 168

Wheel rims .....	160	Wheel trims	
Beadlock .....	160	Full hub caps .....	175
Bolted trims .....	161	Hub caps .....	174
See "Wheels and tyres" .....	158	Wheel bolts caps .....	175
Wheels .....	199	Windows .....	52
Wheels and tyres .....	158	Window wiper .....	60
Avoiding damage .....	159	Windscreen	
Changing a wheel .....	174	Heat-insulating glass .....	59
Code .....	167	Windscreen washer .....	60
Damaged tyres .....	163	Windscreen washer water	
Errors in wheel alignment .....	164	Checking .....	154
Foreign bodies in the tyres .....	164	Topping up .....	154
Interchanging tyres .....	159	Windscreen wiper .....	60
New tyres .....	161	Windscreen wipers	
Older tyres .....	160	Functions .....	61
Replacing tyres .....	161	Headlight washer system .....	61
Run-out .....	164	Heated windscreen washer jets .....	61
Serial number .....	168	Lifting the wiper blades .....	61
Snow chains .....	169	Replacing the wiper blades .....	61
Spare wheel .....	165	Service position .....	61
Speed rating .....	168, 169	Special features .....	61
storing the replaced wheel .....	165	Windscreen wipers service position .....	61
Storing tyres .....	160	Windscreen with metal coating .....	59
Technical data .....	167	Windscreen with reflective infrared coating .....	59
Temporary spare wheel .....	165		
Tread depth .....	163	<b>Other Characters</b>	
Tyre code .....	167	"Safe" security system	
Tyre identification number (TIN) .....	168	SAFELOCK .....	48
Tyre load rating .....	169	SAFE locking .....	48
Tyre pressures .....	162		
Tyres with directional tread pattern .....	159, 169		
Valve caps .....	163		
Wear indicators .....	163		
Wear of tyres .....	164		
Wheel balance .....	164		
Wheel rims .....	160		

SEAT S.A. is permanently concerned about continuous development of its types and models. For this reason we ask you to understand, that at any given time, changes regarding shape, equipment and technique may take place on the car delivered. For this reason no right at all may derive based on the data, drawings and descriptions in this current handbook.

All texts, illustrations and standards in this handbook are based on the status of information at the time of printing. Except for error or omission, the information included in the current handbook is valid as of the date of closing print.

Re-printing, copying or translating, whether total or partial is not allowed unless SEAT allows it in written form.

SEAT reserves all rights in accordance with the "Copyright" Act.

All rights on changes are reserved.

 This paper has been manufactured using bleached non-chlorine cellulose.

© SEAT S.A. - Reprint: 15.11.14

Inglés 1SL012720BC (11.14)



1SL012720BC

