

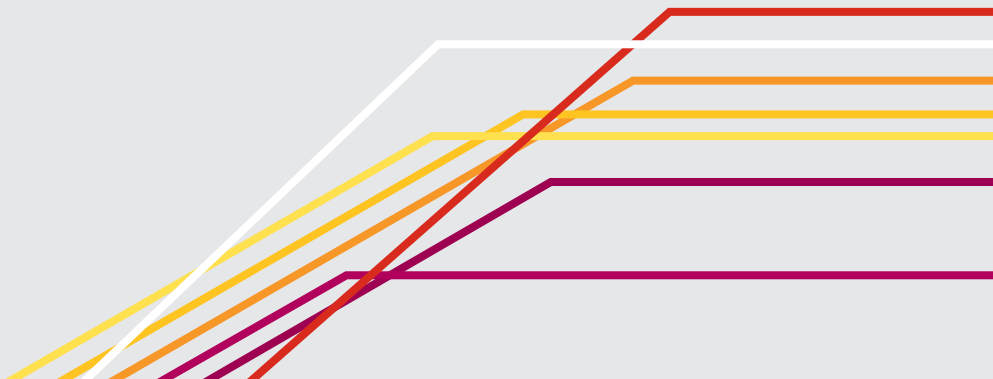

LEON

Owner's manual



Foreword

This Instruction Manual and its corresponding supplements should be read carefully to familiarise yourself with your vehicle.

Besides the regular care and maintenance of the vehicle, its correct handling will help preserve its value.

For safety reasons, always note the information concerning accessories, modifications and part replacements.

If selling the vehicle, give all of the on-board documentation to the new owner, as it should be kept with the vehicle.

Table of Contents

Manual structure	5	Operating instructions	59	Driving	143
Content	6	Controls and displays	59	Steering	143
Safety First	7	Overview	58	Ignition lock	144
Safe driving	7	Instruments and warning/control lamps	61	Kick-down	146
Brief introduction	7	Instruments	61	Handbrake	147
Sitting position for vehicle occupants	10	Control lamps	69	Hill hold assist*	148
Pedal area	16	Driver information system	73	Speed warning function	149
Storing objects	17	Information system	73	Start-Stop system*	149
Seat belts	19	Introduction to the Easy Connect system*	79	Manual gearbox	152
Brief introduction	19	System settings (CAR)*	79	Automatic gearbox/DSG automatic gearbox*	154
Why wear seat belts?	21	Opening and closing	86	Driver assistance systems	164
Seat belts	25	Central locking system	86	Cruise control system (CCS)*	164
Seat belt tensioners	28	Anti-theft alarm system	93	Lane Assist system*	168
Airbag system	30	Emergency locking and unlocking	96	SEAT Drive Modes*	171
Brief introduction	30	Rear lid (luggage compartment)	98	Tiredness detection (break recommendation)*	173
Front airbags	35	Electric windows	100	Tyre monitoring systems	175
Knee airbag*	38	Panoramic sliding sunroof*	103	Parking aid	178
Side airbags*	39	Lights and visibility	106	Practical Tips	183
Curtain airbags*	42	Lights	106	Intelligent technology	183
Deactivating airbags	44	Sun blind	115	Electronic Stability Control (ESC)	183
Child safety	47	Windscreen wiper system	116	Brakes	185
Brief introduction	47	Rear vision mirror	122	Electro-mechanical steering	186
Child seats	49	Seats and storage	125	Power Management	187
Securing child seats	52	General notes	125	Information recorded in the control units	189
		Front seats	125	Driving and the environment	190
		Seat functions	126	Running in the engine	190
		Storage	127	Driving through flooded roads	190
		Luggage compartment	129	Installation of exhaust gas filtration systems	190
		Air conditioning	131	Economic and ecological driving	191
		Heating, ventilation, cooling	134	Environmental friendliness	192

Trailer	194	Changing tail light bulbs (on rear lid)	259
Trailer towing	194	Changing number plate light bulbs	261
Retrofitting a towing bracket*	196		
Care and cleaning	198	Technical specifications	263
General information	198	Technical specifications	263
Care of vehicle exterior	198	Important	263
Care of the vehicle interior	202	Vehicle identification data	264
Checking and refilling levels	206	Information on fuel consumption	265
Fuel	206	Towing a trailer	265
Filling the tank	207	Wheels	266
Bonnet	209	Engine specifications	267
Engine oil	211	Dimensions and capacities	276
Cooling system	215		
Brake fluid	217	Index	277
Battery	217		
Windscreen washer reservoir and wiper blades ..	220		
Wheels and tyres	223		
Wheels	223		
Accessories and modifications to the vehicle	230		
Accessories, replacement parts and repairs	230		
Technical modifications	230		
Radio transmitters and business equipment ...	230		
Emergencies	232		
General information	232		
Equipment	232		
Tyre repair kit	233		
Changing a wheel	235		
Spare wheel	240		
Jump starting	241		
Towing and tow-starting the vehicle	244		
Fuses and bulbs	249		
Electrical fuses	249		
Bulbs	252		
Changing bulbs in headlight unit	254		
Changing bulb for front fog light	256		
Changing tail light bulbs (on side panel)	257		

Manual structure

What you should know before reading this manual

This manual contains a description of the **equipment** supplied with the vehicle at the time of press. Some of the equipment hereunder described will not be available until a later date, or is only available in certain markets.

Because this is a general manual for the LEON, some of the equipment and functions that are described in this manual are not included in all types or variants of the model or model year; they may vary or be modified in accordance with technical or market requirements or model year; this can not be interpreted as dishonest advertising.

The **illustrations** are intended as a general guide and may vary from the equipment fitted in your vehicle in some details.

The **direction indications** (left, right, front, rear) appearing in this manual refer to the normal forward working direction of the vehicle except when otherwise indicated.

The equipment marked with an asterisk** is fitted as standard only in certain versions, and is only supplied as optional extras for some versions, or are only offered in certain countries.

- © All registered marks are indicated with ©. Although the copyright symbol does not appear, it is a copyrighted mark.
- ▶ The section is continued on the following page.
- Marks the **end of a section**.



WARNING

Texts preceded by this symbol contain information on safety. They warn you about possible dangers of accident or injury.



CAUTION

Texts with this symbol draw your attention to potential sources of damage to your vehicle.



For the sake of the environment

Texts preceded by this symbol contain relevant information concerning environmental protection.



Note

Texts preceded by this symbol contain additional information. ■

Content

This manual is structured to provide the information you need in an organised way. The content of this Manual is divided into **sections** which belong to **chapters** (e.g. "Air conditioning"). The entire manual is divided into five large parts which are:

1. Safety First

Information about the vehicle equipment relating to passive safety such as seat belts, airbags, seats, etc.

2. Operating instructions

Information about the distribution of controls in the driver position of your vehicle, about the seat adjustment possibilities, about how to create a suitable climate in the vehicle interior, etc.

3. Practical Tips

Advice relating to the driving, caring and maintenance of your vehicle and certain problems you can solve yourself.

4. Technical specifications

Figures, values and the dimensions of your vehicle.

5. Alphabetic index

At the end of this manual there is a detailed alphabetical index, this will help you to quickly find the information you require. ■

Safety First

Safe driving

Brief introduction

Dear SEAT Driver

Safety first!

This chapter contains important information, tips, suggestions and warnings that you should read and consider for both your own safety and for your passengers' safety.

WARNING

- This manual contains important information about the operation of the vehicle, both for the driver and the passengers. The other sections of the on-board documentation also contain further information that you should be aware of for your own safety and for the safety of passengers.
- Ensure that the on-board documentation is kept in the vehicle at all times. This is especially important when lending or selling the vehicle to another person. ■

Safety equipment

The safety equipment is a part of the occupant protection system and can reduce the risk of injury in the event of an accident.

Never put your safety or the safety of your passengers in danger. In the event of an accident, the safety equipment may reduce the risk of injury. The following list includes most of the safety equipment in your SEAT:

- Three-point seat belts
- Belt tension limiters for the front and rear side seats
- Belt tensioners for the front seats
- Front airbags
- Knee airbags,
- Side airbags in the front seat backrests
- Side airbags in the rear seat backrests*
- Curtain airbags
- ISOFIX anchor points for child seats in the rear side seats with the ISOFIX system,
- Height-adjustable front head restraints
- Rear head restraints with in-use position and non-use position
- Adjustable steering column

The safety equipment mentioned above works together to provide you and your passengers with the best possible protection in the event of an accident. However, these safety systems can only be effective if you and your ►

passengers are sitting in a correct position and use this equipment properly.

Therefore, information is provided about why this equipment is so important, how it protects you, what you have to consider when using it and how you and your passengers can achieve the greatest possible benefit from the safety equipment fitted. This manual includes important warnings that you and your passengers should note in order to reduce the risk of injury.

Safety is everyone's business!

Before starting every trip

The driver is always responsible for the safety of the passengers and the safe operation of the vehicle.

For your own safety and the safety of your passengers, always note the following points before every trip:

- Make sure that the vehicle's lights and turn signals are working properly.
- Check tyre pressure.
- Ensure that all windows provide a clear and good view of the surroundings.
- Make sure all luggage is secured ⇒ page 17.
- Make sure that no objects can interfere with the pedals.
- Adjust front seat, head restraint and rear vision mirrors properly according to your size.

- Ensure that the passengers in the rear seats always have the head restraints in the in-use position ⇒ page 15
- Instruct passengers to adjust the head restraints according to their height.
- Protect children with appropriate child seats and properly applied seat belts ⇒ page 47.
- Assume the correct sitting position. Instruct your passengers also to assume a proper sitting position. ⇒ page 10.
- Fasten your seat belt securely. Instruct your passengers also to fasten their seat belts properly. ⇒ page 19.

What affects driving safety?

Driving safety is largely determined by your driving style and the personal behaviour of all vehicle occupants.

As a driver, you are responsible for yourself and your passengers. When your concentration or driving safety is affected by any circumstance, you endanger yourself as well as others on the road ⇒ ⚠, for this reason:

- Always pay attention to traffic and do not get distracted by passengers or telephone calls.
- Never drive when your driving ability is impaired (e.g. by medication, alcohol, drugs).
- Observe traffic laws and speed limits.

- Always reduce your speed as appropriate for road, traffic and weather conditions.
- When travelling long distances, take breaks regularly - at least every two hours.
- If possible, avoid driving when you are tired or stressed.

**WARNING**

When driving safety is impaired during a trip, the risk of injury and accidents increases.

Sitting position for vehicle occupants

Introduction

WARNING

- The front seats, head restraints and seat belts must always be adjusted to the size of the vehicle occupant to provide you and your passengers with the greatest possible protection.
- Ensure your correct sitting position before setting off, and do not change this during the journey. Also advise your passengers to ensure their correct sitting positions not to be changed.
- A vehicle occupant sitting in an incorrect position is at risk of serious injury in the event that an airbag is activated.
- If the passengers in the rear seats are not sitting in an upright position, they are more likely to be injured due to the incorrect position of the seat belts.
- It is important that the driver keeps at a minimum of 25 cm from the steering wheel. It is important that the passenger keeps at a minimum of 25 cm from the dash panel. The airbag system will not be able to give the required protection if the minimum distance is not observed. This can cause a risk of fatal injury!
- When driving, always hold the steering wheel with both hands on the outside part at the 9 o'clock and 3 o'clock positions. Never hold the steering wheel at the 12 o'clock position, or in any other manner (e.g. in the centre of the steering wheel or along its interior edge). In such cases, if the airbag is triggered, you may sustain injuries to the arms, hands and head.
- The backrests must not be reclined too far back while driving. This could limit the effect of the seat belts and the airbag system. Risk of injury!

WARNING (Continued)

- Objects must not be placed in the footwell, as they could move to the area of the pedals in the event of a braking manoeuvre or change of direction. This would prevent the clutch, brake or accelerator from being pressed.
- Always keep your feet on the footwell when the vehicle is moving; never rest them on the dash panel, on the window or on the seat! An incorrect sitting position exposes you to an increased risk of injury in case of a sudden braking or an accident. If the airbag is triggered, you could sustain severe injuries due to an incorrect sitting position!

Correct sitting position for driver

The correct sitting position for the driver is important for safe and relaxed driving.

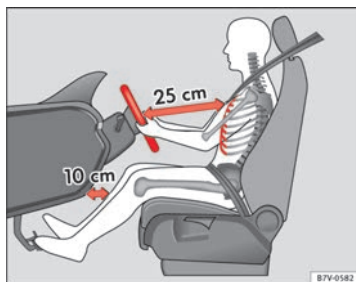



Fig. 1 The correct distance between driver and steering wheel



Fig. 2 Correct head restraint position for driver

For your own safety and to reduce the risk of injury in the event of an accident, we recommend the following adjustments for the driver:

- Adjust the steering wheel so that there is a distance of at least 25 cm between the steering wheel and the centre of your chest ⇒ Fig. 1.
- Move the driver seat forwards or backwards so that you are able to press the accelerator, brake and clutch pedals to the floor with your knees still slightly angled ⇒ .
- Ensure that you can reach the highest point of the steering wheel.
- Adjust the head restraint so that its upper edge is at the same level as the top of your head, or as close as possible to the same level as the top of your head ⇒ Fig. 2.
- Move the seat backrest to an upright position so that your back rests completely against it.
- Fasten your seat belt securely ⇒ page 19.
- Keep both feet in the footwell so that you have the vehicle under control at all times.

Adjustment of the driver seat ⇒ page 125. 

**WARNING**

- An incorrect sitting position of the driver can lead to severe injuries.
- Adjust the driver seat so that there is at least 25 cm distance between the centre of the chest and the centre of the steering wheel ⇒ Fig. 1. If you are sitting closer than 25 cm, the airbag system cannot protect you properly.
- If your physical constitution prevents you from maintaining the minimum distance of 25 cm, contact a specialised workshop. The workshop will help you decide if special specific modifications are necessary.
- When driving, always hold the steering wheel with both hands on the outside of the ring at the 9 o'clock and 3 o'clock positions. This reduces the risk of injury when the driver airbag is triggered.
- Never hold the steering wheel at the 12 o'clock position, or in any other manner (e.g. in the centre of the steering wheel). In such cases, if the airbag is triggered, you may sustain injuries to the arms, hands and head.
- To reduce the risk of injury to the driver during sudden braking manoeuvres or an accident, never drive with the backrest tilted far back! The airbag system and seat belts can only provide optimal protection when the backrest is in an upright position and the driver is wearing his or her seat belt correctly. The further the seat backrests are tilted to the rear, the greater the risk of injury due to incorrect positioning of the belt web or to the incorrect sitting position!
- Adjust the head restraint properly to achieve optimal protection.

Correct sitting position for front passenger

The front passenger must sit at least 25 cm away from the dash panel so that the airbag can provide the greatest possible protection in the event that it is triggered.

For your own safety and to reduce the risk of injury in the event of an accident, we recommend the following adjustments for the front passenger:

- Move the front passenger seat back as far as possible ⇒
- Move the seat backrest to an upright position so that your back rests completely against it.
- Adjust the head restraint so that its upper edge is at the same level as the top of your head, or as close as possible to the same level as the top of your head ⇒ page 14.
- Always keep both feet in the footwell in front of the front passenger seat.
- Fasten your seat belt securely ⇒ page 19.

It is possible to deactivate the front passenger airbag in **exceptional circumstances** ⇒ page 26.

Adjusting the front passenger seat ⇒ page 125.

 **WARNING**

- An incorrect sitting position of the front passenger can lead to severe injuries.
- Adjust the front passenger seat so that there is at least 25 cm between your chest and the dash panel. If you are sitting closer than 25 cm, the airbag system cannot protect you properly.
- If your physical constitution prevents you from maintaining the minimum distance of 25 cm, contact a specialised workshop. The workshop will help you decide if special specific modifications are necessary.
- Always keep your feet in the footwell when the vehicle is moving; never rest them on the dash panel, out the window or on the seat. An incorrect sitting position exposes you to an increased risk of injury in case of a sudden braking or an accident. If the airbag is triggered, you could sustain severe injuries due to an incorrect sitting position.
- To reduce the risk of injury to the front passenger in events such as sudden braking manoeuvres or an accident, never travel with the backrest tilted far back! The airbag system and seat belts can only provide optimal protection when the backrest is in an upright position and the front passenger is wearing his or her seat belt properly. The further the seat backrests are tilted to the rear, the greater the risk of injury due to incorrect positioning of the belt web or to the incorrect sitting position!
- Adjust the head restraint correctly in order to achieve maximum protection.

Correct sitting position for passengers in the rear seats

Passengers in the rear seats must sit up straight, keep their feet in the footwells, have the head restraints positioned for use and wear their seat belts properly.

To reduce the risk of injury in the event of a sudden braking manoeuvre or an accident, passengers on the rear seat bench must consider the following:

- Adjust the head restraint to the correct position. ⇒ page 15
- Always keep both feet in the footwell in front of the rear seat.
- Fasten your seat belt securely ⇒ page 19.
- Use an appropriate child restraint system when you take children in the vehicle ⇒ page 47.

 **WARNING**

- If the passengers in the rear seats are not sitting properly, they could sustain severe injuries.
- Adjust the head restraint correctly in order to achieve maximum protection.
- Seat belts can only provide optimal protection when seat backrests are in an upright position and the vehicle occupants are wearing their seat belts correctly. If passengers in the rear seats are not sitting in an upright position, the risk of injury due to incorrect positioning of the seat belt increases.

Correct adjustment of front seat head restraints

Properly adjusted head restraints are an important part of passenger protection and can reduce the risk of injuries in most accident situations.

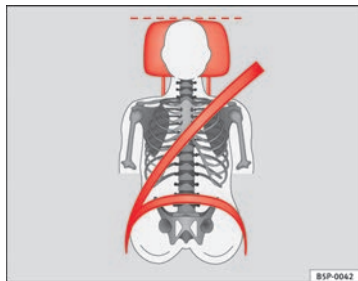

Fig. 3 Correctly adjusted head restraint viewed from the front

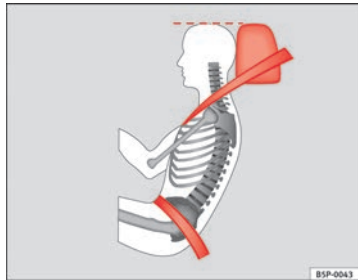

Fig. 4 Correctly adjusted head restraint viewed from the side

Adjust the head restraint correctly in order to achieve maximum protection.

- Adjust the head restraint so that its upper edge is at the same level as the top of your head, or as close as possible to the same level as the top of your head and, at the very least, at eye level. ⇒ Fig. 3 and ⇒ Fig. 4.

Adjusting the head restraints ⇒ page 127



WARNING

- Travelling with the head restraints removed or improperly adjusted increases the risk of severe injuries.
- Incorrectly adjusted head restraints could result in death in the event of a collision or accident.
- Incorrectly adjusted head restraints also increase the risk of injury during sudden or unexpected driving or braking manoeuvres.
- The head restraints must always be adjusted according to the height of the passenger.

Correct adjustment of rear seat head restraints

Properly adjusted head restraints are an important part of the passenger protection and can reduce the risk of injuries in most accident situations

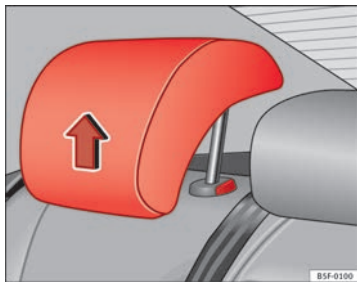

Fig. 5 Head restraints in correct position

Rear head restraints

- The rear head restraints have 2 positions: **use** and **non-use**.
- One position for **use** (head restraint raised) ⇒ Fig. 5. In this position, the head restraints are used normally, protecting passengers along with the rear seat belts.
- And one position for **non-use** (head restraint lowered).
- To fit the head restraints in position for use, pull on the edges with both hands in the direction of the arrow.

⚠ WARNING

- Under no circumstances should the rear passengers travel while the head restraints are in the non-use position.
- Do not swap the centre rear head restraint with either of the outer seat rear head restraints.
- Risk of injury in case of an accident!

⚠ CAUTION

Note the instructions on the adjustment of the head restraints ⇒ page 127. ■

Examples of incorrect sitting positions

An incorrect sitting position can lead to severe injuries to vehicle occupants.

Seat belts can provide optimal protection only when the belt webs are properly positioned. Incorrect sitting positions substantially reduce the protective function of seat belts and increase the risk of injury due to incorrect seat belt position. As the driver, you are responsible for all passengers, especially children.

- Never allow anyone to assume an incorrect sitting position in the vehicle while travelling ⇒ ⚠.

The following list contains examples of sitting positions that could be dangerous for all vehicle occupants. The list is not complete, but we would like to make you aware of this issue.

Therefore, whenever the vehicle is in motion:

- Never stand in the vehicle.
- Never stand on the seats. ▶

- Never kneel on the seats.
- Never tilt your seat backrest far to the rear.
- Never lean against the dash panel.
- Never lie on the rear bench.
- Never sit on the front edge of a seat.
- Never sit sideways.
- Never lean out of a window.
- Never put your feet out of a window.
- Never put your feet on the dash panel.
- Never put your feet on the surface of a seat.
- Do not allow anyone to travel in the footwell.
- Never travel without wearing the seat belt.
- Do not allow anyone to travel in the luggage compartment.



WARNING

- Any incorrect sitting position increases the risk of severe injuries.
- Sitting in an incorrect position exposes the vehicle occupants to severe injuries if airbags are triggered, by striking a vehicle occupant who has assumed an incorrect sitting position.
- Before the vehicle moves, assume the proper sitting position and maintain it throughout the trip. Before every trip, instruct your passengers to sit properly and to stay in this position during the trip → page 10, Sitting position for vehicle occupants.

Pedal area

Pedals

The operation of all pedals must never be impaired by objects or floor mats.

- Ensure that you can always press the accelerator, brake and clutch pedals unimpaired to the floor.
- Ensure that the pedals can return unimpaired to their initial positions.

Use only floor mats which leave the pedal area free and can be securely fastened on the footwell.

If a brake circuit fails, the brake pedal must be pressed down thoroughly in order to stop the vehicle.

Wearing suitable shoes

Always wear shoes which support your feet properly and give you a good feeling for the pedals.



WARNING

- Restricting pedal operation can lead to critical situations while driving.
- Never place objects on the driver footwell. An object could move into the pedal area and impair pedal operation. In the event of a sudden driving or braking manoeuvre, you will not be able to operate the brake, clutch or accelerator pedal. Risk of accident!

Floor mats on the driver side

Only floor mats may be used which can be securely fastened in the footwell and do not impair operation of the pedals.

- Ensure that the floor mats are securely fastened during the trip and do not obstruct the pedals → .

Only use floor mats which leave the pedals clear and which are secured to prevent them from slipping. You can obtain suitable floor mats from a specialised dealership. Fasteners* for floor mats are fitted in the footwells.

WARNING

- If the pedals are obstructed, an accident may occur. Risk of serious injuries.
- Ensure that the floor mats are always securely attached.
- Never lay or fit floor mats or other floor coverings over the original floor mats. This would reduce the pedal area and could obstruct the pedals. Risk of accident.

Storing objects

Loading the luggage compartment

All luggage and other loose objects must be safely secured in the luggage compartment.

Unsecured objects which shift back and forth could impair the driving safety or driving characteristics of the vehicle by shifting the centre of gravity.

- Distribute the load evenly in the luggage compartment.
- Place heavy objects as far forward as possible in the luggage compartment.
- Place the heavy objects first.
- Secure heavy objects to the fitted fastening rings → page 18.

WARNING

- Loose luggage and other objects in the luggage compartment could cause serious injuries.
- Always stow objects in the luggage compartment and secure them on the fastening rings.
- Use suitable straps to secure heavy objects.
- During sudden manoeuvres or accidents, loose objects can be thrown forward, injuring vehicle occupants or passers-by. This increased risk of injury will be further increased if a loose object is struck by an inflating airbag. If this happens, objects can be transformed into "missiles". Risk of fatal injury.
- Please note that the centre of gravity may shift when transporting heavy objects; this may affect vehicle handling and lead to an accident. Therefore, it is essential to adjust your speed and driving style accordingly, to avoid accidents.
- Never exceed the allowed axle weights or allowed maximum weight. If the allowed axle load or the allowed total weight is exceeded, the driving characteristics of the vehicle may change, leading to accidents, injuries and damage to the vehicle.
- Never leave your vehicle unattended, especially when the rear lid is open. Children could climb into the luggage compartment, closing the door behind them; they will be trapped and run the risk of death.

⚠ WARNING (Continued)

- **Never allow children to play in or around the vehicle. Close and lock all the doors and rear lid when you leave the vehicle. Before you lock the vehicle, make sure that there are no adults or children in the vehicle.**
- **Never transport passengers in the luggage compartment. All vehicle occupants must have their seat belt fastened ⇒ page 19.**

**Note**

- Air circulation in the vehicle helps reduce fogging of the windows. Used air escapes through ventilation slits in the side trim of the luggage compartment. Ensure that the ventilation slits are never covered.
- Straps for securing the load to the fastening rings are commercially available. ■

Fastening rings*

There can be four fastening rings in the luggage compartment for fastening luggage and other objects.

- Always use suitable and undamaged straps to secure luggage and other objects to the fastening rings ⇒ ⚠ in Loading the luggage compartment on page 17.

Bear in mind that in the case of a collision or accident, even small and light objects that are not firmly fixed can be projected at the occupants causing injury.

Example: An object weighing 4.5 kg is lying unsecured in the vehicle. During a frontal collision at a speed of 50 km/h (30 mph), this object generates a force corresponding to 20 times its weight. That means that the effective weight of the object increases to about 90 kg. You can imagine the severity of the injuries which might be sustained if this object strikes an occupant as

it flies through the interior of the vehicle. This increased risk of injury will be further increased if a loose object is struck by an inflating airbag.

**WARNING**

- **If pieces of luggage or other objects are secured to the fastening rings with inappropriate or damaged retaining cords, injuries could be sustained in the event of braking manoeuvres or accidents.**
- **To prevent pieces of luggage or other objects from flying forward, always use appropriate retaining cords which are secured to the fastening rings.**
- **Never secure a child seat on the fastening rings.** ■

Seat belts

Brief introduction

Before driving: remember your seat belt!

Wearing a seat belt properly can save your life!

In this section you will learn the importance of wearing seat belts, how they work and how to properly fasten, adjust and wear them.

- Read and consider all the information as well as the warnings in this chapter.

WARNING

- If seat belts are worn incorrectly or not at all, the risk of severe injuries increases.
- Properly worn seat belts can reduce severe injuries in case of sudden braking manoeuvres or accidents. For safety reasons, you and all other vehicle occupants must always wear the seat belts properly while the vehicle is moving.
- Pregnant women or people with physical disabilities must also use seat belts. Like all other vehicle occupants, these people can also sustain severe injuries if they are not wearing their seat belts properly.

Number of seats

Your vehicle has **five** seats, two in the front and three in the rear. Each seat is equipped with a three-point seat belt.

In some versions, your vehicle is approved **only** for four seats. Two front seats and two rear seats.

WARNING

- Never transport more than the permitted amount of people in your vehicle.
- Every vehicle occupant must properly fasten and wear the seat belt belonging to his or her seat. Children must be protected with an appropriate child restraint system.

Seat belt warning lamp*

The control lamp acts as a reminder to the driver to fasten the seat belt.

Before starting the vehicle:

- Fasten your seat belt securely.
- Instruct your passengers to fasten their seat belts properly before driving off.
- Protect children by using a child seat according to the child's height and weight.

After the ignition has been switched on, the control lamp  on the instrument panel lights up¹⁾ if the driver has not fastened his/her seat belt, and an audible warning is heard if the vehicle is driven at more than 30 km/h (20 mph).

The warning lamp*  is switched off if the driver seat belt is fastened while the ignition is switched on. ■

¹⁾ Depending on the model version

Why wear seat belts?

Physical principles of frontal collisions

In the event of a frontal collision, a large amount of kinetic energy must be absorbed.

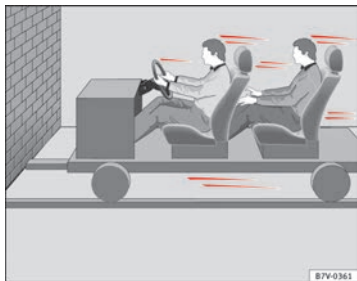

Fig. 6 Vehicle about to hit a wall: the occupants are not wearing seat belts



Fig. 7 The vehicle hits the wall: the occupants are not wearing seat belts

It is easy to explain how the laws of physics work in the case of a head-on collision: When a vehicle starts moving \Rightarrow Fig. 6, a certain amount of energy known as kinetic energy is produced in the vehicle and its occupants.

The amount of kinetic energy depends on the speed of the vehicle and the weight of the vehicle and its passengers. The higher the speed and the greater the weight, the more energy there is to be released in an accident.

The most significant factor, however, is the speed of the vehicle. If the speed doubles from 25 km/h (15 mph) to 50 km/h (30 mph), for example, the kinetic energy is multiplied by four.

Because the vehicle occupants in our example are not restrained by seat belts, all of the occupants' kinetic energy has to be absorbed at the point of impact \Rightarrow Fig. 7.

Even at speeds of 30 km/h (20 mph) to 50 km/h (30 mph), the forces acting on bodies in a collision can easily exceed one tonne (1000 kg). At greater speed these forces are even higher. \blacktriangleright

Vehicle occupants not wearing seat belts are not “attached” to the vehicle. In a head-on collision, they will move forward at the same speed their vehicle was travelling just before the impact. This example applies not only to head-on collisions, but to all accidents and collisions. ■

The danger of not using the seat belt

The general belief that the passengers can protect themselves with their hands in a minor collision is false.



Fig. 8 A driver not wearing a seat belt is thrown forward violently



Fig. 9 The unbelted passenger in the rear seat is thrown forward violently, hitting the driver wearing a seat belt

Even at low speeds the forces acting on the body in a collision are so great that it is not possible to brace oneself with one's hands. In a frontal collision, unbelted vehicle occupants are thrown forward and will make violent contact with the steering wheel, dash panel, windscreen or whatever else is in the way → Fig. 8.

The airbag system is not a substitute for seat belts. When triggered, airbags provide only additional protection. All occupants (including the driver) must wear seat belts properly at all times during the trip. This will reduce the risk of severe injuries in the event of an accident – regardless of whether an airbag is fitted for the seat or not.

Note that airbags can be triggered only once. To achieve the best possible protection, the seat belt must always be worn properly so that you will be protected in accidents in which no airbag is deployed.

It is also important for the rear passengers to wear seat belts properly, as they could otherwise be thrown forward violently through the vehicle interior in an accident. Passengers in the rear seats who do not use seat belts endanger not only themselves but also the front occupants → Fig. 9. ■

Seat belt protection

Passengers not wearing seat belts risk severe injuries in the event of an accident.



Fig. 10 A driver wearing the seat belt properly is secured by the belt in sharp braking

Properly worn seat belts hold the vehicle occupants in the correct sitting positions and substantially reduce the kinetic energy in the event of an accident. Seat belts also help to prevent uncontrolled movements that could lead to severe injuries. In addition, properly worn seat belts reduce the danger of being thrown from the vehicle.

Vehicle occupants wearing their seat belts correctly benefit greatly from the ability of the belts to absorb kinetic energy. The front part of your vehicle and other passive safety features (such as the airbag system) are also designed to absorb the kinetic energy released in a collision. Taken together, all these features reduce the releasing kinetic energy and consequently, the risk of injury.

Our examples describe frontal collisions. Of course, properly worn seat belts substantially reduce the risk of injury in all other types of accidents. This is why it is so important to fasten seat belts before every trip, even when "just driving around the corner".

Ensure that your passengers wear their seat belts as well. Accident statistics have shown that wearing seat belts is an effective means of substantially reducing the risk of injury and improving the chances of survival in a serious accident. Furthermore, properly worn seat belts improve the protection provided by airbags in the event of an accident. For this reason, wearing a seat belt is required by law in most countries.

Although your vehicle is equipped with airbags, the seat belts must be fastened and worn. The front airbags, for example, are only triggered in some frontal accidents. The front airbags will not be triggered during minor frontal collisions, minor side collisions, rear collisions, overturns or accidents in which the airbag trigger threshold value in the control unit is not exceeded.

Therefore, you should always wear your seat belt and ensure that all vehicle occupants have fastened their seat belts properly before you drive off! ■

Safety instructions on using seat belts

If seat belts are used correctly, they can considerably reduce the risk of injury in an accident.

- Always wear the seat belt as described in this section.
- Ensure that the seat belts can be fastened at all times and are not damaged. ▶

**WARNING**

- If the seat belts are worn incorrectly or not at all, the risk of severe injuries increases. The optimal protection from seat belts can be achieved only if you use them properly.
- Fasten your seat belt before every trip - even when driving in town. The other vehicle occupants must also wear the seat belts at all times, otherwise they run the risk of being injured.
- The seat belt cannot offer its full protection if the seat belt is not positioned correctly.
- Never allow two passengers (even children) to share the same seat belt.
- Always keep both feet in the footwell in front of your seat as long as the vehicle is in motion.
- Never unbuckle a seat belt while the vehicle is in motion. Risk of fatal injury.
- The seat belt must never be twisted while it is being worn.
- The seat belt should never lie on hard or fragile objects (such as glasses or pens, etc.) because this can cause injuries.
- Do not allow the seat belt to be damaged or jammed, or to rub on any sharp edges.
- Never wear the seat belt under the arm or in any other incorrect position.
- Loose, bulky clothing (such as an overcoat over a jacket) impairs the proper fit and function of the seat belts, reducing their capacity to protect.
- The slot in the seat belt buckle must not be blocked with paper or other objects, as this can prevent the latch plate from engaging securely.
- Never use seat belt clips, fastening rings or similar instruments to alter the position of the belt webbing.

**WARNING (Continued)**

- Frayed or torn seat belts or damage to the connections, belt retractors or parts of the buckle could cause severe injuries in the event of an accident. Therefore, you must check the condition of all seat belts at regular intervals.
- Seat belts which have been worn in an accident and stretched must be replaced by a specialised workshop. Renewal may be necessary even if there is no apparent damage. The belt anchorage should also be checked.
- Do not attempt to repair a damaged seat belt yourself. The seat belts must not be removed or modified in any way.
- The belts must be kept clean, otherwise the retractors may not work properly.

Seat belts

Seat belt adjustment

The seat belts for the front and rear occupants are locked into position by a latch.

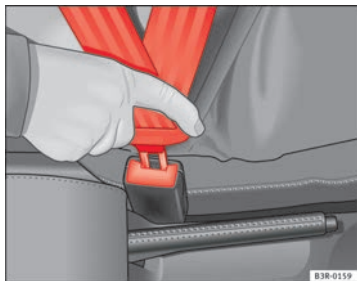

Fig. 11 Belt buckle and latch plate of seat belt

The seat belt cannot offer its full protection if the seat belt is not positioned correctly.

- Adjust the seat and head restraint correctly.
- To fasten the belt, take hold of the latch plate and pull it slowly across your chest and lap.
- Insert the latch plate into the buckle for the appropriate seat and push it down until it is securely locked with an audible click ⇒ Fig. 11.

- Pull the belt to ensure that the latch plate is securely engaged in the buckle.

The seat belts are equipped with an automatic retractor on the shoulder strap. Full freedom of movement is permitted when the shoulder belt is pulled slowly. However, during sudden braking, during travel in steep areas or bends and during acceleration, the automatic retractor on the shoulder belt is locked.

The automatic belt retractors on the front seats are fitted with seat belt tensioners ⇒ page 28.



WARNING

- An incorrectly worn seat belt can cause severe injuries in the event of an accident.
- The seat belts offer best protection only when the backrests are in an upright position and the seat belts have been fastened properly.
- Never put the latch plate in the buckle of another seat. If you do this, the seat belt will not protect you properly and the risk of injury is increased.
- If a vehicle occupant is incorrectly belted in, the seat belt cannot protect him or her properly. An incorrectly positioned seat belt can cause extremely severe injuries.
- Always engage the retractor lock when you are securing a child seat in group 0, 0+ or 1 ⇒ page 47.

Seat belt position

Seat belts offer their maximum protection only when they are properly positioned.

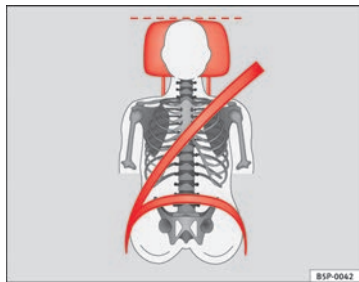

Fig. 12 Correct seat belt and head restraint positions, viewed from front

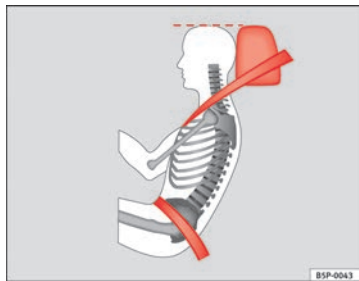

Fig. 13 Correct seat belt and head restraint positions, viewed from side

The following features are available to adjust the seat belt in the shoulder region:

- front seat height adjustment*.

WARNING

- An incorrectly worn seat belt can cause severe injuries in the event of an accident.
- The shoulder part of the seat belt must lie on the centre of the shoulder, never across the neck. The seat belt must lie flat and snugly on the torso ⇒ Fig. 12.
- The lap part of the seat belt must lie across the pelvis, never across the stomach. The seat belt must lie flat and snugly on the pelvis ⇒ Fig. 13. Pull the belt tight if necessary to take up any slack.
- Read and observe the warnings ⇒ page 23.

Pregnant women must also fasten their seat belts properly

The best protection for the unborn child is for the mother to wear the seat belt properly at all times during the pregnancy.



Fig. 14 Positioning seat belts during pregnancy

The seat belt provides maximum protection only when the seat belt is properly positioned ⇒ page 26.

- Adjust the front seat and head restraint correctly ⇒ page 10.
- Holding the latch plate, pull the belt evenly across your chest and as low as possible over the pelvis ⇒ Fig. 14.
- Insert the latch plate into the buckle for the corresponding seat and push it down until it is securely locked with an audible click ⇒ ⚠.
- Pull the belt to ensure that the latch plate is securely engaged in the buckle.

⚠ WARNING

- An incorrectly worn seat belt can cause severe injuries in the event of an accident.
- For pregnant women, the lap part of the seat belt must lie as low as possible over the pelvis, never across the stomach, and always lie flat so that no pressure is exerted on the abdomen.
- Read and observe the warnings ⇒ page 23.

Seat belt release

The seat belt must not be unfastened until the vehicle has come to a standstill.

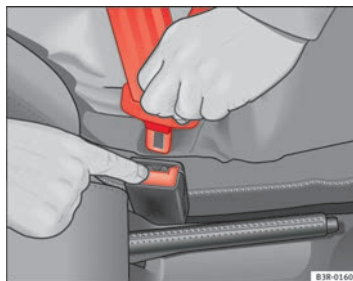

Fig. 15 Remove latch plate from buckle

- Press the red button on the belt buckle ⇒ Fig. 15. The latch plate is released and springs out ⇒ ⚠.

- Guide the belt back by hand so that it rolls up easily and the trim is not damaged.

**WARNING**

Never unbuckle a seat belt while the vehicle is in motion. If you do, you increase the risk of sustaining severe or fatal injuries.

Incorrectly fastened seat belts

Incorrectly worn seat belts can cause severe or even mortal injuries.

Seat belts can provide optimal protection only if the belt web is properly worn. The seat belts must be fastened exactly in the order described in this chapter. An incorrect sitting position impairs substantially the protection a seat belt offers and can lead to severe or fatal injuries. The risk of severe or fatal injuries is especially increased when a deploying airbag strikes a vehicle occupant who has assumed an incorrect sitting position. As the driver, you are responsible for yourself and all passengers, especially children. Therefore:

- Never allow anyone to wear the seat belt incorrectly while the vehicle is moving ⇒

**WARNING**

- An incorrectly worn seat belt increases the risk of severe injuries.
- Before every trip, instruct your passengers to adjust their seat belts properly and to wear them for the whole journey.
- Read and always observe information and warnings concerning the use of seat belts ⇒ page 23.

Seat belt tensioners

Function of the seat belt tensioner

During a frontal collision, the seat belts on the front seats are retracted automatically.

The seat belts for the occupants in the front seats are equipped with belt tensioners. Sensors will only trigger the belt tensioners during severe head-on, lateral and rear collisions, and only if the seat belt is actually being worn. This retracts and tightens the seat belts, reducing the forward motion of the occupants.

The seat belt tensioner can be triggered only once.

The seat belt tensioners will not be triggered in the event of a light frontal, side or rear collision, if the vehicle overturns or in situations where no large forces act on the front, side or rear of the vehicle. ▶

**Note**

- If the seat belt tensioners are triggered, a fine dust is produced. This is normal and it is not an indication of fire in the vehicle.
- The relevant safety requirements must be observed when the vehicle or components of the system are scrapped. Specialised workshops are familiar with these regulations, which are also available to you. ■

Service and disposal of belt tensioners

The belt tensioners are components of the seat belts that are installed in the seats of your vehicle. If you work on the belt tensioners or remove and install parts of the system when performing other repair work, the seat belt may be damaged. The consequence may be that, in the event of an accident, the belt tensioners function incorrectly or not at all.

So that the effectiveness of the seat belt tensioner is not reduced and that removed parts do not cause any injuries or environmental pollution, regulations, which are known to the specialised workshops, must be observed.

**WARNING**

- **Improper use or repairs not carried out by qualified mechanics increase the risk of severe or fatal injuries. The belt tensioners may fail to trigger or may trigger in the wrong circumstances.**
- **Never attempt to repair, adjust, remove or install parts of the belt tensioners or seat belts.**
- **The seat belt tensioner, seat belt and automatic retractor cannot be repaired.**

**WARNING (Continued)**

- **Any work on the belt tensioners and seat belts, including the removal and refitting of system parts in conjunction with other repair work, must be performed by a specialised workshop only.**
- **The belt tensioners will only provide protection for one accident and must be changed if they have been activated.** ■

Airbag system

Brief introduction

Why wear a seat belt and assume the correct sitting position?

For the inflating airbags to achieve the best protection, the seat belt must always be worn properly and the correct sitting position must be assumed.

For your own safety and the safety of the passengers, please ensure the following before driving:

- Always wear the seat belt properly ⇒ page 19.
- Adjust the driver seat and the steering wheel correctly ⇒ page 11.
- Adjust the front passenger seat correctly ⇒ page 12.
- Adjust the head restraint correctly ⇒ page 14.
- Use the correct child restraint system to protect children in your vehicle ⇒ page 47.

The airbag is deployed at high speed in fractions of a second. If you have an incorrect seating position at the time the airbag is deployed, it could cause you critical injuries. Therefore, it is essential that all vehicle occupants assume a correct sitting position while travelling.

Sharp braking before an accident may cause a passenger not wearing a seat belt to be thrown forward into the area of the deploying airbag. In this case,

the inflating airbag may inflict critical or fatal injuries on the occupant. This also applies to children.

Always maintain the greatest possible distance between yourself and the front airbag. This way, the front airbags can completely deploy when triggered, providing their maximum protection.

The most important factors that will trigger an airbag are: the type of accident, the angle of collision and the speed of the vehicle.

Whether the airbags are triggered depends primarily on the vehicle deceleration rate resulting from the collision and detected by the control unit. If the vehicle deceleration occurring during the collision and measured by the control unit remains below the specified reference values, the front, side and/or curtain airbag will not be triggered. Take into account that the visible damage in a vehicle involved in an accident, no matter how serious, is not a determining factor for the airbags to have been triggered.



WARNING

- **Wearing the seat belt incorrectly or assuming an incorrect sitting position can lead to critical or fatal injuries.**
- **All vehicle occupants, including children, who are not properly belted can sustain critical or fatal injuries if the airbag is triggered. Children up to 12 years old should always travel on the rear seat. Never transport children in the vehicle if they are not restrained or the restraint system is not appropriate for their age, size or weight.**
- **If you are not wearing a seat belt, if you lean forward or to the side while travelling or assume an incorrect sitting position, there is a substantially increased risk of injury. This increased risk of injury will be further increased if you are struck by an inflating airbag.**

⚠ WARNING (Continued)

- To reduce the risk of injury from an inflating airbag, always wear the seat belt properly ⇒ page 19.
- Always adjust the front seats properly.

The danger of fitting a child seat on the front passenger seat

Rear-facing child seats must never be used on the front passenger seat when the front passenger airbag is enabled.

The front passenger front airbag is a serious risk for a child if it is activated. The front passenger seat is life threatening to a child if he/she is transported in a rear-facing child seat. Children up to 12 years old should always travel on the rear seat.

If a rear-facing child seat is secured to the front passenger seat, an inflating airbag can strike it with such force that it can cause critical or fatal injuries.

Therefore we strongly recommend you to transport children on the rear seats. That is the safest place for children in the vehicle. Alternatively, the front passenger airbag can be disabled with a key-operated switch ⇒ page 44. When transporting children, use a child seat suitable for the age and size of each child ⇒ page 47.





For those vehicles that do not include a key lock switch to turn the airbag off, a Technical Service must be consulted.

⚠ WARNING

- If a child seat is secured to the front passenger seat, the risk to the child of sustaining critical or fatal injuries in the event of an accident increases.
- Never secure a rear-facing child seat to the front passenger seat if the front passenger airbag is enabled. The child can suffer critical or fatal injuries if the front passenger airbag is triggered.
- An inflating front passenger airbag can strike the rear-facing child seat and project it with great force against the door, the roof or the backrest.
- For those vehicles that do not include a key lock switch to turn the airbag off, a Technical Service must be consulted.
- If, under special circumstances, it is necessary to transport a child in a rear-facing child seat on the front passenger seat, it is absolutely essential that you observe the following safety measures:
 - Deactivate the front passenger airbag ⇒ page 44.
 - Child seats must be approved by the child seat manufacturer for use on a front passenger seat with front or side airbag.
 - Follow the installation instructions given by the child seat manufacturer and observe the safety instructions ⇒ page 47, Child safety.
 - Before properly installing the child seat, push the front passenger seat completely backwards so that the greatest possible distance to the front passenger airbag is ensured.
 - Ensure that no objects prevent the front passenger seat from being pushed completely back.
 - The backrest of the front passenger seat must be in an upright position.

Types of front passenger front airbag systems

There are two different SEAT front passenger front airbag systems:

A	B
<p>Characteristics of the front passenger front airbag that can only be disabled in a specialised workshop.</p> <ul style="list-style-type: none"> – Control lamp  on the instrument panel. – Front passenger front airbag on the dash panel. 	<p>Characteristics of the front passenger front airbag that can be disabled manually → page 44.</p> <ul style="list-style-type: none"> – Control lamp  on the instrument panel. – Control lamp on the dash panel. PASSENGER AIR BAG OFF . – Control lamp on the dash panel. PASSENGER AIR BAG ON . – Switch on the dash panel glove compartment, on the passenger side. – Front passenger front airbag in the dash panel.
<p>Name: airbag system.</p>	<p>Name: airbag system with front passenger front airbag disabling. ■</p>

Control lamp



Fig. 16 Control lamp for disabling the front passenger front airbag on the dash panel

lights up	Digit	Possible cause	Solution
	Instrument panel	Fault in airbag system and seat belt tensioners.	Have the system checked immediately by a specialised workshop.
OFF	Dash panel	Fault in the airbag system.	Have the system checked immediately by a specialised workshop.
		Front passenger front airbag disabled.	Check whether the airbag should remain disabled.
ON	Dash panel	Front passenger front airbag enabled.	No solution. The control lamp switches off about 60 seconds after ignition is turned on or after enabling of the front passenger front airbag with the key lock switch.

Several warning and control lamps should light up for a few seconds when the ignition is switched on, signalling that the function is being verified. They will switch off after a few seconds.

If the **PASSENGER AIR BAG OFF** control lamp **does not remain lit** or if it is lit together with the control lamp on the instrument panel and the front passenger front airbag is disabled, there may be a fault in the airbag system
⇒ ⚠

**WARNING**

In the event of a fault in the airbag system, the airbag may not trigger correctly, may fail to trigger or may even trigger unexpectedly, leading to severe or fatal injuries.

- Have the airbag system checked immediately by a specialised workshop.
- Never mount a child seat in the front passenger seat or remove the mounted child seat! The front passenger front airbag may deploy during an accident in spite of the fault.

**CAUTION**

Always pay attention to any lit control lamps and to the corresponding descriptions and instructions to avoid damage to the vehicle.

Repairs, maintenance and disposal of airbags

The parts of the airbag system are installed in various places in your vehicle. If work is carried out on the airbag system or parts have to be removed and fitted on the system when performing other repair work, parts of the airbag system may be damaged. In the event of an accident this could cause the airbag to inflate incorrectly or not inflate at all.

The relevant safety requirements must be observed when the vehicle or components of the airbag are **scrapped**. Specialised workshops and vehicle disposal centres are familiar with these requirements.

**WARNING**

- If repairs are not carried out by a professional, or if the airbags are used incorrectly, the risk of severe or fatal injuries is increased. The airbags may fail to inflate, or could inflate in the wrong circumstances.
- Do not cover or stick anything on the steering wheel hub or the surface of the airbag unit on the passenger side of the dash panel, and do not obstruct or modify them in any way.
- It is important not to attach any objects such as cup holders or telephone mountings to the surfaces covering the airbag units.
- To clean the steering wheel or dash panel, you may use only a dry or a water-moistened cloth. Never clean the dash panel and the airbag module surface with cleaners containing solvents. Solvents cause the surface to become porous. If the airbag triggered, plastic parts could become detached and cause injuries.
- Never attempt to repair, adjust, remove or install parts of the airbag system.
- Any work on the airbag system or removal and installation of the airbag components for other repairs (such as repairs to the steering wheel) should be performed only by a specialised workshop. Specialised workshops have the necessary tools, repair information and qualified personnel.
- We strongly recommend you to go to a specialised workshop for all work on the airbag system.
- Never attempt to alter the front bumper or the body.
- The airbags provide protection for just one accident; replace them once they have deployed.

**For the sake of the environment**

The airbags, which are a special type of waste, must be disposed of through an authorised service, because they contain pyrotechnic elements.

Front airbags

Description of front airbags

The airbag system is not a substitute for the seat belts.



Fig. 17 Driver airbag located in steering wheel



Fig. 18 Front passenger airbag located in dash panel

The front airbag for the driver is located in the steering wheel ⇒ Fig. 17 and the airbag for the front passenger is located in the dash panel ⇒ Fig. 18. Airbags are identified by the word “AIRBAG”.

In conjunction with the seat belts, the front airbag system gives the front occupants additional protection for the head and chest in the event of a severe frontal collision ⇒ page 37, Safety notes on the front airbag system.

In addition to their normal function of restraining the occupants, the seat belts also hold the driver and front passenger in a position where the airbags can provide maximum protection in a frontal collision.

The airbag system is not a substitute for seat belts, but it is an integral part of the vehicle's overall passive safety system. Please bear in mind that the airbag system can only work effectively when the vehicle occupants are wearing their seat belts correctly and have adjusted the head restraints properly. Therefore, it is most important to wear the seat belts at all times, not only because this is required by law in most countries, but also for your safety ⇒ page 19, Brief introduction.

The main parts of the front airbag system are:

- an electronic control and monitoring system (control unit)
- the two front airbags (airbag with gas generator) for the driver and front passenger
- a control lamp  in the dash panel

The airbag system operation is monitored electronically. The airbag control lamp will light up for a few seconds every time the ignition is switched on (self-diagnosis).

There is a fault in the system if the control lamp :

- does not light up when the ignition is switched on
- turns off after 4 seconds after the ignition is switched on
- turns off and then lights up again after the ignition is switched on
- lights up or flashes while the vehicle is moving

The front airbag system will not be triggered if:

- the ignition is switched off
- there is a minor frontal collision
- there is a side collision
- there is a rear-end collision
- the vehicle turns over

! WARNING

- The seat belts and airbags can only provide maximum protection if the occupants are seated correctly ⇒ page 10, Sitting position for vehicle occupants.
- If a fault has occurred in the airbag system, have the system checked immediately by a specialised workshop. Otherwise, during a frontal collision the system may fail to trigger, or not trigger correctly.

Operation of front airbags

Inflated airbags reduce the risk of injuries to the head or chest.

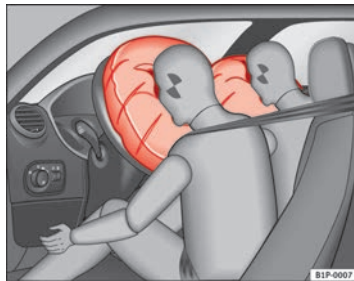

Fig. 19 Inflated front airbags

The airbag system is designed so that the airbags for the driver and front passenger are triggered in a severe frontal collision.

In certain types of accident the front, curtain and side airbags may be triggered together.

When the system is triggered, the airbags fill with a propellant gas and deploy in front of the driver and front passenger ⇒ Fig. 19. The fully deployed airbags cushion the forward movement of the front occupants and help to reduce the risk of injury to the head and the upper part of the body.

The special design of the airbag allows the controlled escape of the propellant gas when an occupant puts pressure on the bag. Thus, the head and chest are surrounded and protected by the airbag. After the collision, the airbag deflates sufficiently to allow visibility. ▶

The airbags deploy extremely rapidly, within thousandths of a second, to provide additional protection in the event of an accident. A fine dust may develop when the airbag deploys. This is normal and it is not an indication of fire in the vehicle.

Airbag covers when the frontal airbags are triggered

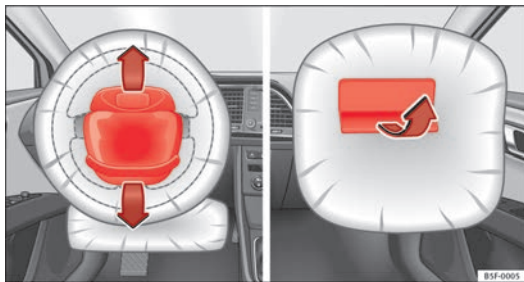

Fig. 20 Airbag covers reacting when the front airbags are triggered

The airbag covers fold out of the steering wheel or dash panel when the driver and front passenger airbags are triggered ⇒ Fig. 20. The airbag covers remain connected to the steering wheel or the dash panel.

Safety notes on the front airbag system

If you use airbags correctly, they can considerably reduce the risk of injury in many kinds of accident.

WARNING

- It is important for the driver and front passenger to keep a distance of at least 25 cm from the steering wheel and dash panel. If the minimum distance is not observed then the airbags do not correctly protect the vehicle occupants; risk of fatal injuries! In addition, the front seats and head restraints must always be positioned correctly for the height of the occupant.
- If you are not wearing a seat belt, if you lean forward or to the side while travelling or assume an incorrect sitting position, there is a substantially increased risk of injury. This increased risk of injury will be further increased if you are struck by an inflating airbag.
- Never let a child travel on the front seat without an appropriate restraint system. If the airbag is triggered in an accident, children can sustain serious or fatal injuries from the airbag as it inflates ⇒ page 47.
- The deployment space between the front passengers and the airbags must not in any case be occupied by other passenger, pets and objects.
- The airbags provide protection for just one accident; replace them once they have deployed.
- It is also important not to attach any objects such as cup holders or telephone mountings to the surfaces covering the airbag units.
- Do not attempt to modify components of the airbag system in any way.

Knee airbag*

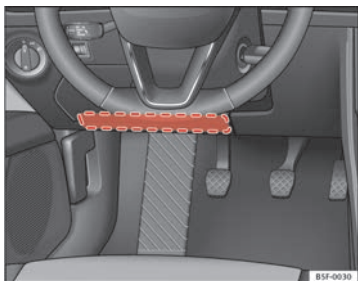

Fig. 21 On the driver side: location of the knee airbag



Fig. 22 On the driver side: Radius of action of the knee airbag

The knee airbag is located on the driver side below the dash panel
 ⇒ Fig. 21. Airbags are identified by the word "AIRBAG".

The area framed in red ⇒ Fig. 22 is covered by the knee airbag when it is deployed (deployment area). Therefore, objects should never be placed or mounted in these areas.

WARNING

The airbag is deployed at high speed in fractions of a second.

- The knee airbag is deployed in front of the driver's knees. Always keep the deployment areas of the knee airbags free.
- Never not fix objects to the cover or in the deployment area of the knee airbag.
- Adjust the driver seat so that there is a distance of at least 10 cm (4 inches) between your knees and the location of the knee airbag. If your physical constitution prevents you from meeting these requirements, make sure you contact a specialised workshop.

Side airbags*

Description of side airbags

The airbag system is not a substitute for the seat belts.

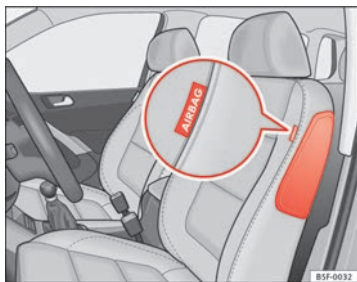

Fig. 23 Side airbag in driver seat

The side airbags are located in the backrest cushions of the driver seat → Fig. 23 and the front passenger seat as well as in the rear seats*. The locations are identified by the text "AIRBAG" in the upper region of the backrests.

Together with the seat belts, the side airbag system gives the front seat occupants additional protection for the upper body in the event of a severe side collision → page 41, Safety notes on the operation of the side airbag system.

In a side collision, the side airbags reduce the risk of injury to passengers on the front seats to the areas of the body facing the impact. In addition to their normal function of protecting the occupants in a collision, the seat belts also hold the passengers in the front seats and the outer rear seats in a position where the side airbags can provide maximum protection.

The airbag system is not a substitute for seat belts, but it is an integral part of the vehicle's overall passive safety system. Please bear in mind that the airbag system can only work effectively when the occupants are wearing their seat belts. Therefore, it is most important to wear the seat belts at all times, not only because this is required by law in most countries, but also for your safety → page 19, Brief introduction.

The side airbag system will not be triggered if:

- the ignition is switched off
- there is a minor side collision
- there is a frontal collision
- there is a rear-end collision
- the vehicle turns over

The main parts of the airbag system are:

- an electronic control and monitoring system (control unit)
- the side airbags in the sides of the backrests of the front and rear seats
- a control lamp  in the dash panel

The airbag system operation is monitored electronically. The airbag control lamp will light up for approx. 4 seconds every time the ignition is switched on (self-diagnosis).

WARNING

- **In a side-on collision the side airbags will not work if the sensors do not correctly measure the pressure increase on the interior of the doors, due to air escaping through the areas with holes or openings in the door panel.**
- **Never drive the vehicle if the interior panels have been removed.**
- **Never drive if the interior door panels have been removed or if the panels have not been correctly fitted.**

 **WARNING** (Continued)

- Never drive the vehicle if the loudspeakers in the door panels have been removed, unless the holes left by the loudspeakers have been correctly closed.
- Always check that the openings are closed or covered if loudspeakers or other equipment are fitted in the interior door panels.
- Any work carried out to the doors should be made in an authorised specialised workshop.
- The seat belts and airbags can only provide maximum protection if the occupants are seated correctly ⇒ page 10, Sitting position for vehicle occupants.
- If a fault has occurred in the airbag system, have the system checked immediately by a specialised workshop. Otherwise, during a side collision, the system may fail to trigger, or not trigger correctly.

Operation of side airbags

Inflated airbags can reduce the risk of head or chest injury in many side impact collisions.

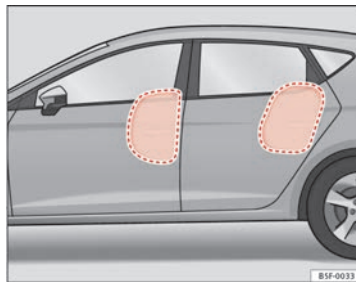

Fig. 24 Illustration of completely inflated side airbags on left side of vehicle

In some **side collisions**, the side airbag is triggered on the impact side of the vehicle ⇒ Fig. 24.

In certain types of accident the front, curtain and side airbags may be triggered together.

When the system is triggered, the airbag is filled with propellant gas.

The airbags deploy extremely rapidly, within thousandths of a second, to provide additional protection in the event of an accident. A fine dust may develop when the airbag deploys. This is normal and it is not an indication of fire in the vehicle.

The fully deployed airbags cushion the movement of the occupants of the front seats and the outer rear seats and help to reduce the risk of injury to the upper body.

The special design of the airbag allows the controlled escape of the propellant gas when an occupant puts pressure on the bag. Thus, the head and chest are surrounded and protected by the airbag.

Safety notes on the operation of the side airbag system

If airbags are used correctly, they can considerably reduce the risk of injury in side impact collisions.

WARNING

- If you do not wear a seat belt, if you lean forward, or are not seated correctly while the vehicle is in motion, you are at a greater risk of injury if the side airbag system is triggered in an accident.
- In order for the side airbags to provide their maximum protection, the prescribed sitting position must always be maintained with seat belts fastened while travelling.
- Occupants of the outer seats must never carry any objects or pets in the deployment space between them and the airbags, or allow children or other passengers to travel in this position. It is also important not to attach any accessories (such as cup holders) to the doors. This would impair the protection offered by the side airbags.
- The built-in coat hooks should be used only for lightweight clothing. Do not leave any heavy or sharp-edged objects in the pockets.
- Great forces, such as hard blows or kicks, must not be exerted upon the backrest bolster because the system may be damaged. In this case, the side airbags would not be triggered.

WARNING (Continued)

- Under no circumstances should protective covers be fitted over seats with side airbags unless the covers have been approved for use in your vehicle. Because the airbag deploys from the side of the backrest, the use of conventional seat covers would obstruct the side airbag, seriously reducing the airbag's effectiveness.
- Any damage to the original seat upholstery or around the seams of the side airbag units must be repaired immediately by a specialised workshop.
- The airbags provide protection for just one accident; replace them once they have deployed.
- When children assume an incorrect sitting position, they expose themselves to an increased risk of injury in the event of an accident. This is particularly the case if the child is travelling on the front passenger seat and the airbag system is triggered in an accident; this could have critical consequences including serious injury or death ⇒ page 47.
- Any work on the side airbag system or removal and installation of the airbag components for other repairs (such as removal of the front seat) should only be performed by a specialised workshop. Otherwise, faults may occur during the airbag system operation.
- Do not attempt to modify components of the airbag system in any way.
- The side and head airbags are managed through sensors located in the interior of the front doors. To ensure the correct operation of the side and head airbags neither the doors nor the door panels should be modified in any way (e.g. fitting loudspeakers). If the front door is damaged, the airbag system may not work correctly. All work carried out on the front door must be done in a specialised workshop.

Curtain airbags*

Description of curtain airbags

The airbag system is not a substitute for the seat belts.



Fig. 25 Location of curtain airbags

The curtain airbags are located on both sides in the interior above the doors ⇒ Fig. 25 and are identified with the text “AIRBAG”.

In conjunction with the seat belts, the curtain airbag system gives the vehicle occupants additional protection for the head and upper body in the event of a severe side collision ⇒ page 43, Safety notes on the operation of the curtain airbag system.

The airbag system is not a substitute for seat belts, but it is an integral part of the vehicle's overall passive safety system. Please bear in mind that the airbag system can only work effectively when the vehicle occupants are wearing their seat belts correctly and have adjusted the head restraints properly. Therefore, it is most important to wear the seat belts at all times,

not only because this is required by law in most countries, but also for your safety ⇒ page 19, Brief introduction.

The main parts of the curtain airbag system are:

- an electronic control and monitoring system (control unit)
- the curtain airbags (airbags with gas generator) for the driver, front passenger and passengers on the rear seats
- a control lamp  in the dash panel

The airbag system operation is monitored electronically.

The curtain airbag system will not be triggered if:

- the ignition is switched off
- there is a frontal collision
- there is a rear-end collision
- the vehicle turns over
- there is a minor side collision

WARNING

If a fault has occurred in the airbag system, have the system checked immediately by a specialised workshop. Otherwise there is a danger that during a collision, the system may fail to trigger, or not trigger correctly. ■

Operation of curtain airbags

Fully inflated airbags reduce the risk of head or chest injury in a side collision.

During some **side collisions** the curtain airbag is triggered on the impact side of the vehicle ⇒ Fig. 25. ▶

In certain types of accident the front, side and curtain airbags may be triggered together.

When the system is triggered, the airbag is filled with propellant gas. In the process, the curtain airbag covers the side windows and door pillars.

The airbags deploy extremely rapidly, within thousandths of a second, to provide additional protection in the event of an accident. A fine dust may develop when the airbag deploys. This is normal and it is not an indication of fire in the vehicle.

The fully deployed airbags cushion the movement of the front occupants and help to reduce the risk of injury to the upper body.

The special design of the airbag allows the controlled escape of the propellant gas when an occupant puts pressure on the bag. Thus, the head and chest are surrounded and protected by the airbag.

Safety notes on the operation of the curtain airbag system

If you use airbags correctly, they can considerably reduce the risk of injury in many kinds of accident.

WARNING

- In order for the side airbags to provide their maximum protection, the prescribed sitting position must always be maintained with seat belts fastened while travelling.
- For safety reasons, the curtain airbag must be disabled in those vehicles fitted with a screen dividing the interior of the vehicle. See a Technical Service to make this adjustment.

WARNING (Continued)

- There must be no other persons, animals or objects between the occupants of the outer seats and the deployment space of the curtain airbags so that the curtain airbag can deploy without restriction and provide the greatest possible protection. Therefore, sun blinds which have not been expressly approved for use in your vehicle may not be attached to the side windows.
- The built-in coat hooks should be used only for lightweight clothing. Do not leave any heavy or sharp-edged objects in the pockets. Please, do not hang the clothes on coat hangers.
- The airbags provide protection for just one accident; replace them once they have deployed.
- Any work on the curtain airbag system or removal and installation of the airbag components for other repairs (such as removal of the roof lining) should only be performed by a specialised workshop. Otherwise, faults may occur during the airbag system operation.
- Do not attempt to modify components of the airbag system in any way.
- The side and head airbags are managed through sensors located in the interior of the front doors. To ensure the correct operation of the side and head airbags neither the doors nor the door panels should be modified in any way (e.g. fitting loudspeakers). If the front door is damaged, the airbag system may not work correctly. All work carried out on the front door must be done in a specialised workshop.

Deactivating airbags

Deactivating airbags

The deactivation of airbags corresponds only to certain cases, i.e. if:

- a child seat is required in the front passenger seat with the child facing in the opposite direction to the direction of travel (in some countries, due to divergent legal requirements, facing in the direction of travel) ⇒ page 49;
- despite the driver seat being in the correct position, a minimum distance of 25 cm cannot be maintained between the centre of the steering wheel and the driver's torso.
- installation of special devices is required in the steering wheel area due to a physical disability.
- if you have special seats installed (e.g. an orthopaedic seat without side airbag).

The front passenger front airbag can be disabled using the switch
⇒ page 45.

We recommend that you contact an authorised SEAT dealer for the disabling of other airbags.



Airbag system control

The airbag system availability is controlled electronically, regardless of whether an airbag is disabled.

If an airbag was disabled using a diagnostics system:

- the airbag system warning lamp  lights up after switching on the ignition for about 4 seconds, and then flashes for about 12 seconds

If the airbag has been disabled with the airbag switch on the side of the dash panel:

- the airbag control lamp  will light up for about 4 seconds after the ignition is switched on.
- The airbag is disabled, signalled with the warning lamp **OFF** ; which lights up with the word **PASSENGER AIR BAG OFF** ; placed in the centre part of the dash panel ⇒ Fig. 26.



Note

- Respect the current legislation in your country regarding the deactivation of airbags
- At your authorised SEAT dealer you can find information on which vehicle airbags can be deactivated. ■

Front passenger front airbag switch



Fig. 26 Front passenger front airbag switch





Fig. 27 Warning lamp for disabling the front passenger airbag



The switch disables only the front passenger front airbag.

Disabling the airbag

- Switch the ignition off.

- Open the glove compartment on the front passenger side.
- Turn the airbag switch slot with the key to the **OFF** position ⇒ Fig. 26.
- Check, with the ignition switched on, that the control lamp **OFF**  ⇒ Fig. 27 lights up with the word **PASSENGER AIR BAG OFF**  in the centre part of the dash panel.

Switching on the airbag

- Switch the ignition off.
- Turn the airbag switch slot with the key to the **ON** position ⇒ Fig. 26.
- Close the passenger side storage compartment.
- Check, with the ignition switched on, that the control lamp **OFF**  ⇒ Fig. 27 does not light up, with the word **PASSENGER AIR BAG OFF**  in the centre part of the dash panel.
- The warning lamp **ON**  is illuminated for 60 seconds in the centre part of the dash panel.

Control lamp with the word PASSENGER AIR BAG OFF (front passenger airbag disabled)

If the front passenger front airbag is **disabled**, after switching on the ignition, the control lamp will light up for several seconds, then it will switch off for about 1 s and then switch on again.

If the control lamp is flashing, there is a fault in the disabling of the airbag system ⇒ . **Please go immediately to an Official Service.** ▶

**WARNING**

- The driver of the vehicle is responsible for disabling or switching on the airbag.
- Always switch off the ignition before disabling the front passenger airbag! Failure to do so could result in a fault in the airbag deactivation system.
- If the control lamp OFF  (airbag deactivated) flashes, the front passenger front airbag will not trigger in the event of an accident! Have the system immediately checked by an Official Service.

Child safety

Brief introduction

Introduction

Statistics show that children are generally safer on the rear seat than on the front passenger seat.

For safety reasons we recommend that children under 12 years of age travel on the rear seats. Depending on their age, height and weight, children travelling on the rear seat must use a child seat or a seat belt. For safety reasons, the child seat should be installed in the centre of the rear seat or behind the front passenger seat.

The physical laws involved and the forces acting in a collision apply also to children → page 21.

But unlike adults, children do not have fully developed muscle and bone structures. This means that children are subject to a greater risk of injury.

To reduce this risk, children must always use special child restraint systems when travelling in the vehicle.

We recommend the use of child safety products from the SEAT Original Accessories Programme, which includes systems for all ages made by "Peke"¹⁾.

These systems have been especially designed and approved, complying with the ECE-R44. regulation.

¹⁾ Not for all countries

Follow the manufacturer's instructions and observe any statutory requirements when installing and using child seats. Always read and note → page 47.

We recommend you to always include the manufacturer's Child Seat Instruction Manual together with the on-board documentation. ■

Safety notes on using child seats

Proper use of child seats substantially reduces the risk of injury in an accident!

As the driver, you are responsible for any children you transport in your vehicle.

- Protect your children by properly using the appropriate child seats → page 49.
- Always ensure that the seat belt is properly positioned according to the instructions provided by the manufacturer of the child seat.
- When travelling, do not allow children to distract you from traffic.
- Take breaks regularly during long trips. Take a break at least every two hours. ▶

**WARNING**

- Never install a child seat facing backwards on the front passenger seat unless the front passenger front airbag has been disabled. Risk of potentially fatal injuries to the child! However, if it is necessary, in exceptional cases, to transport a child in the front passenger seat, the front passenger front airbag must always be disabled ⇒ page 44. If the passenger seat has a height adjustment option, move it to the highest, most upright position. If you have a fixed seat, do not install any child restraint system in this location.
- For those vehicles that do not include a key lock switch to deactivate the airbag, the vehicle must be taken to a Technical Service.
- All vehicle occupants, especially children, must assume the proper sitting position and be properly belted in while travelling.
- Never hold children or babies on your lap, this can result in potentially fatal injuries to the child!
- Never allow a child to be transported in a vehicle without being properly secured, or to stand up or kneel on a seat while travelling. In an accident, the child could be flung through the vehicle, causing possibly fatal injuries to themselves and to the other vehicle occupants.
- If children assume an improper sitting position when the vehicle is moving, they expose themselves to greater risk of injury in the event of a sudden braking manoeuvre or in an accident. This is particularly important if the child is travelling on the front passenger seat and the airbag system is triggered in an accident; as this could cause serious injury or even death.
- A suitable child seat can protect your child!
- Never leave an unsupervised child alone on a child seat or in the vehicle.
- Depending on weather conditions, it may become extremely hot or cold inside the vehicle. This can be fatal.

**WARNING (Continued)**

- Children who are less than 1.5 metres tall must not wear a normal seat belt without a child seat, as this could cause injuries to the abdominal and neck areas during a sudden braking manoeuvre or in an accident.
- Do not allow the seat belt to become twisted or jammed, or to rub on any sharp edges.
- Incorrectly worn seat belts can cause injuries even in a minor collision or in sudden braking manoeuvres.
- The seat belt provides maximum protection only when the seat belt is properly positioned ⇒ page 25, Seat belts.
- Only one child may occupy a child seat ⇒ page 49, Child seats.

Child seats

Categorisation of child seats into groups

Use only child seats that are officially approved and suitable for the child.

Child seats are subject to the regulation ECE-R 44. ECE-R stands for: Economic Commission for Europe Regulation

The child seats are grouped into 5 categories:

Group 0: up to 10 kg

Group 0+: up to 13 kg

Group 1: from 9 to 18 kg

Group 2: from 15 to 25 kg

Group 3: from 22 to 36 kg

Child seats that have been tested and approved under the ECE R44 standard bear the test mark on the seat (the letter E in a circle with the test number below it).

Group 0 and 0+ child seats

A suitable child seat and a correctly adjusted seat belt can help you to protect your child.

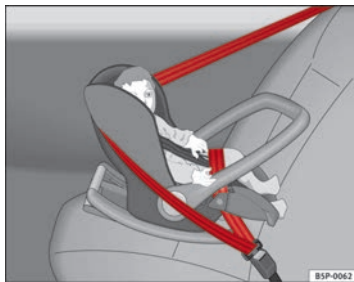

Fig. 28 A group 0 rear-facing child seat fitted on the rear seat

Group 0: Infants up to 10 kg (approx. 9 months) must travel in the direction opposite to travel ⇒ Fig. 28.

Group 0+: Infants up to 13 kg (approx. 18 months) must travel in the direction opposite to travel ⇒ Fig. 28.

Follow the manufacturer's instructions and observe any statutory requirements when installing and using child seats.

We recommend you to always include the manufacturer's Child Seat Instruction Manual together with the on-board documentation.

SEAT recommends the use of child seats from the **Original Accessories catalogue**. These child seats have been designed and tested for use in SEAT vehicles. You can find the right child seat for your model and age group at SEAT dealers. ▶

! WARNING

Read and always observe information and warnings concerning the use of child seats ⇒ page 47.

Group 1 child seats

A suitable child seat and a correctly adjusted seat belt can help you to protect your child.



Fig. 29 A category 1 forward-facing child seat fitted on the rear seat

Babies and young children between 9 and 18 kg can travel in the direction of travel or in the reverse, depending on the seat type. For safety reasons it is recommended that the child is transported in the direction opposite to travel for as long as possible. Consult the instruction manual of the child seat manufacturer for possible installation options.

Follow the manufacturer's instructions and observe any statutory requirements when installing and using child seats.

We recommend you to always include the manufacturer's Child Seat Instruction Manual together with the on-board documentation.

SEAT recommends the use of child seats from the **Original Accessories catalogue**. These child seats have been designed and tested for use in SEAT vehicles. You can find the right child seat for your model and age group at SEAT dealers.

! WARNING

Read and always observe information and warnings concerning the use of child seats ⇒ page 47.

Group 2 and 3 child seats

A suitable child seat and a correctly adjusted seat belt can help you to protect your child.



Fig. 30 Forward-facing child seat installed on rear seat

The child seats in groups 2 and 3 must be mounted in the direction of movement and using the vehicle's seatbelt.

Follow the manufacturer's instructions and observe any statutory requirements when installing and using child seats.

We recommend you to always include the manufacturer's Child Seat Instruction Manual together with the on-board documentation.

SEAT recommends the use of child seats from the **Original Accessories catalogue**. These child seats have been designed and tested for use in SEAT vehicles. You can find the right child seat for your model and age group at SEAT dealers.

Group 2 child seats

Children *under* 7 years of age weighing between 15 and 25 kg are best protected by group 2 child seats together with properly adjusted seat belts.

Group 3 child seats

Children *over* 7 years of age weighing between 22 and 36 kg but less than 1.5 metres tall are best protected by child seats with head restraints together with properly worn seat belts ⇒ [Fig. 30](#).



WARNING

- The shoulder part of the seat belt must lie approximately on the centre of the shoulder, never across the neck or the arm. The seat belt must lie close to the upper part of the body. The lap belt part must lie across the pelvis, not across the stomach, and always fit closely. Pull the belt tight if necessary to take up any slack ⇒ [page 25, Seat belts](#).
- Read and always observe information and warnings concerning the use of child seats ⇒ [page 47](#).

Securing child seats

Ways to secure a child seat

A child seat can be secured differently on the rear seat and on the front passenger seat.

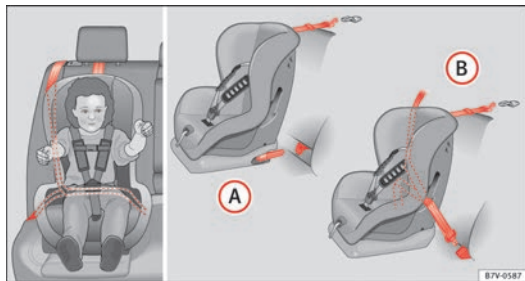

Fig. 31 On the rear seats: figure (A) shows the basic child restraint system mounting using lower retaining rings and the upper retaining strap figure (B) shows the child restraint system mounting using the vehicle seat belt

You can secure a child seat to the rear seat or front passenger seat in the following ways:

- Child seats in groups **0 to 3** can be secured with a seat belt.
- Child seats in groups **0, 0+ and 1** with the ISOFIX and Top Tether* systems can be secured without using the seatbelt, thanks to the ISOFIX and Top Tether* securing rings ⇒ page 54.
- During installation of some models of group I, II and III car seats in the rear seat, difficulty may arise in mounting the seat given that it comes into contact with the head restraint. In this case adjust the height of the head

restraint or remove it from the seat following the instructions in the corresponding chapter ⇒ page 127. Once you remove the car seat, replace the head restraint in its original position. ■

Securing the child seat using the seat belt

The seat belt may be used to secure **universal** type child seats to the vehicle seats marked with a **U** in the table below.

- If the front passenger seat lacks a height adjustment, child seats cannot be mounted in this location.

Mass group	Seating position		
	Front passenger seat	Rear side seat	Rear central seat
Group 0 to 10 kg	U*	U	U
Group 0+ to 13 kg	U*	U	U
Group I 9 to 18 kg	U*	U	U
Group II 15 to 25 kg	U*	U	U
Group III 22 to 36 kg	U*	U	U

U: Suitable for universal restraint systems for use in this mass group.

*: Only compatible for models with adjustable seat height. Place seat in the backmost highest position possible. ►

**WARNING**

- When travelling, children must be secured in the vehicle with a restraint system suitable for age, weight and size.
- Never install a child seat facing backwards on the front passenger seat unless the front passenger airbag has been disabled. This could cause fatal injuries to the child! However, if, in exceptional cases, it is necessary to transport a child in the front passenger seat, the front passenger airbag ⇒ page 44 must always be disabled and the seat adjusted to its backmost highest position, where possible.
- Read and always observe information and warnings concerning the use of child seats ⇒ page 47.

Child seats fastened with the “ISOFIX” and Top Tether* system

Child seats with the “ISOFIX” and TopTether* system can be secured quickly, easily and safely on the rear outer seats.

Two “ISOFIX” retaining rings are fitted on each rear seat. In some vehicles, the rings are secured to the seat frame and, in others, they are secured to the rear floor. The access to the ISOFIX rings is between the rear seat backrest and the seat cushioning. The Top Tether* anchors are located at the rear of the backrests of the rear seats (behind the seat backrest or in the luggage compartment).

To understand the compatibility of the “ISOFIX” systems in the vehicle, consult the table below.

- The allowed body weight for the child seat or information regarding size **A to F** is indicated on the label on the child seat with certification **universal** or **semi-universal**.

Mass group	Size class	Electrical equipment	Mounting direction	Vehicle Isofix positions
				Rear side seats
Baby carrier	F	ISO/L1	Backward-facing	X
	G	ISO/L2	Backward-facing	X
Group 0 to 10 kg	E	ISO/R1	Backward-facing	IU
Group 0+ to 13 kg	E	ISO/R1	Backward-facing	IU
	D	ISO/R2	Backward-facing	IU
	C	ISO/R3	Backward-facing	IU
Group I 9 to 18 kg	D	ISO/R2	Backward-facing	IU
	C	ISO/R3	Backward-facing	IU
	B	ISO/F2	Forward-facing	IU
	B1	ISO/F2X	Forward-facing	IU
	A	ISO/F3	Forward-facing	IU
Group II 15 to 25 kg	---	---	Forward-facing	---
Group III 22 to 36 kg	---	---	Forward-facing	---

- IU: Suitable for ISOFIX universal child restraint systems approved for use in this mass group
- X: ISOFIX position not suitable for ISOFIX child restraint systems for this mass group or size class



⚠ WARNING

- The securing rings are designed only for use with ISOFIX and Top Tether* child seats.
- Never secure child seats that do not have the ISOFIX and Top Tether* system, retaining belts or other objects to the securing rings – this could result in potentially fatal injuries to the child!
- Ensure that the child seat is secured correctly using the “ISOFIX” and Top Tether* securing rings.

- Press the child seat onto the ISOFIX retaining rings until the child seat can be heard to engage securely. If the child seat is equipped with Toptether* anchor points, secure it to the correspondent ring. Observe the manufacturer's instructions.
- Do a test by pulling both sides of the car seat to ensure that it is properly anchored.

Child seats with the ISOFIX and Top Tether* attachment system are available from Technical Services.

ISOFIX child seat mounting system



Fig. 32 ISOFIX securing rings

When removing or fitting the child seat, please be sure to follow the manufacturer's instructions.

- Remove the protective caps of the “ISOFIX” rings by placing a finger in the hole and pulling up ⇒ Fig. 32.

Top Tether retainer straps*

Some child restraint seats have a third Top Tether anchoring point, apart from both “ISOFIX” anchoring points, which allow better child retention.

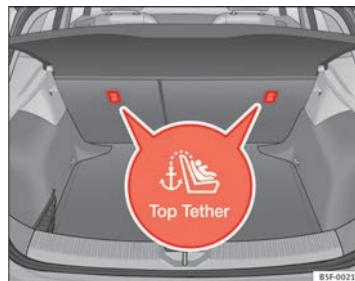

Fig. 33 Position of the Top Tether rings on the back of the rear seat

Child seats with the Top Tether system come with a strap for securing the seat to the vehicle anchor point, located at the back of the rear seat backrest.

The objective of the retainer strap is to reduce forward movements of the child seat in a crash, helping reduce the risk of injuries to the head from hitting the inside of the vehicle.

Using the Top Tether in rear-facing mounted seats

Currently, there are very few rear-facing child safety seats that have Top Tether. Please carefully read and follow the seat manufacturer instructions to learn the proper way to install the Top Tether strap.

Fitting the Top Tether child restraint to the anchoring point

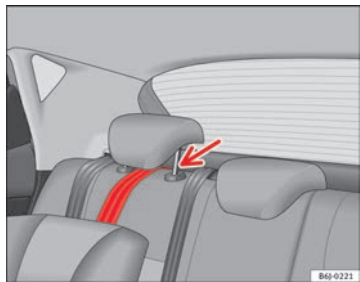

Fig. 34 Retainer strap: correct adjustment and fitting

Securing the Top Tether child restraint to the anchor point situated on the rear of the backrest

- Pull out the fastening belt of the child restraint seat according to the manufacturer's instructions.
 - Guide the Top Tether fastening belt under the rear seat head restraint ⇒ Fig. 34 (lift the head restraint where necessary).
 - Slide the belt so that the Top Tether belt of the child restraint seat is correctly secured to the anchor on the back of the rear seat.
 - Firmly tighten the Top Tether belt following the child restraint seat manufacturer's instructions.
- **Releasing the retaining strap**
- Release the retainer strap in line with the instructions given by the child safety seat manufacturer.
 - Push the lock and release it from the anchoring support.



WARNING

An undue installation of the safety seat will increase the risk of injury in the event of a crash.

- Never tie the retainer strap to a hook in the luggage compartment.
 - Never secure or tie luggage or other items to the lower anchorages (ISOFIX) or the upper ones (Top Tether).
-

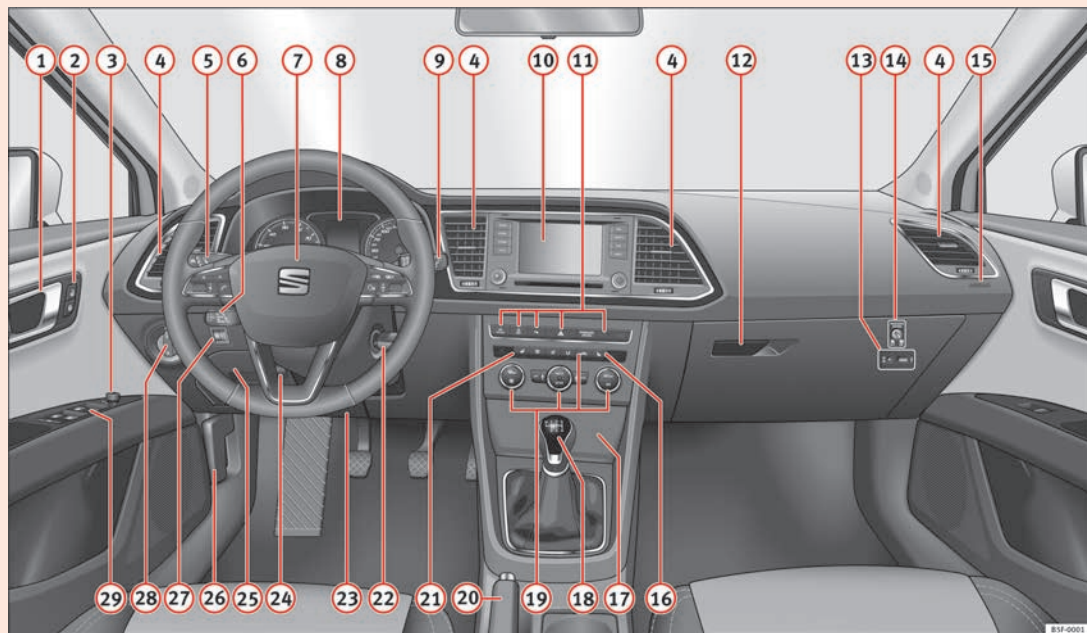

Fig. 35 Controls and displays

Operating instructions

Controls and displays

Overview

①	Door handle	
②	Central locking switch	93
③	Electric control to adjust exterior mirrors	122
④	Air outlets	140
⑤	Control lever for:	
	– Turn signals and main beam headlights	107
	– Lane Assist	168
	– Main beam assist	111
	– Cruise control system (CCS)	164
⑥	Depending on equipment fitted:	
	– Lever for cruise control	164
⑦	Steering wheel with horn and	
	– Driver airbag	35
	– On-board computer controls	73
	– Controls for radio, telephone, navigation and speech dialogue system ⇒ Booklet Radio	
	– Paddle levers for tiptronic gearshift (automatic gearbox)	159
⑧	Instrument panel	61
⑨	Control lever for:	
	– Windscreen wipers and washer	116
	– Wipe and wash system	116
	– On-board computer	73
⑩	Depending on equipment fitted: Radio or display for Easy Connect (navigation, radio, TV/video)	79
⑪	Depending on the equipment, buttons for:	
	– SEAT driving modes	171
	– Start-Stop system	149
	– Park assist system	178
	– Hazard warning lights	110
	– Airbag off display	45
⑫	Glove compartment with CD changer	130
⑬	Depending on the equipment:	
	– Multimedia interface* ⇒ Booklet Radio	
	– Tyre pressure switch	177
⑭	Front passenger airbag switch	45
⑮	Front passenger airbag	35
⑯	Passenger seat heating control	126
⑰	Storage compartment	
⑱	Depending on gearbox fitted, gear lever or selector lever for:	
	– manual gearbox	152
	– automatic gearbox	154
⑲	Depending on the equipment, controls for:	
	– Heating and ventilation system or manual air conditioner	138, 137
	– Automatic air conditioner	135
⑳	Parking brake	147
㉑	Driver seat heating control	126 ▶

22	Ignition lock	144
23	Knee airbag	38
24	Adjustable steering column	143
25	Storage compartment	
26	Bonnet lock release	210
27	Headlight range control	114
28	Light switch	106
29	Electric windows	100

**Note**

- Some of the equipment listed in this section is only fitted on certain models or are optional extras.
- A separate instruction manual is enclosed if the vehicle is equipped with a factory-fitted sound system, CD changer, AUX IN connection, or navigation system.
- The arrangement of switches and controls on right-hand drive models* may be slightly different from the layout shown in ⇒ page 58. However, the symbols used to identify the controls are the same. ■

Instruments and warning/control lamps

Instruments

Introduction

Additional information and warnings:

- Control and warning lamps ⇒ page 69
- SEAT information system
- Easy Connect system
- Gear engaged display (automatic gearbox) ⇒ page 154.
- Instructions for inspection intervals ⇒ Booklet Maintenance Programme

WARNING

Any distraction may lead to an accident, with the risk of injury.

- Do not operate the instrument panel controls when driving.

View of instrument panel

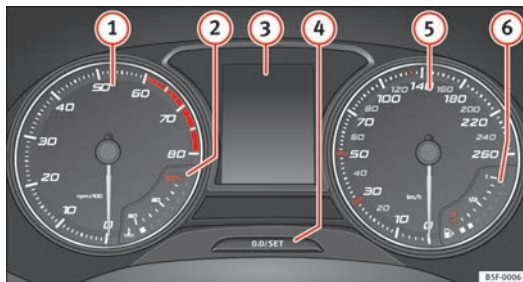

Fig. 36 Instrument panel, on dash panel

Details of the instruments ⇒ Fig. 36:

- ① **Rev counter** (with the engine running, in hundreds of revolutions per minute).

The beginning of the red zone of the rev counter indicates the maximum speed in any gear after running-in and with the engine hot. However, it is advisable to change up a gear or move the selector lever to D (or lift your foot off the accelerator) before the needle reaches the red zone ⇒ ①.

- ② **Engine coolant temperature display**  ⇒ page 215.

- ③ **Displays on the screen** ⇒ page 62.

- ④ **Adjuster button and display** ⇒ page 67

- ⑤ **Speedometer.**

- ⑥ **Fuel reserve display** ⇒ page 207.

**CAUTION**

- To prevent damage to the engine, the rev counter needle should only remain in the red zone for a short period of time.
- When the engine is cold, avoid high revs and heavy acceleration and do not make the engine work hard.

**For the sake of the environment**

Changing up a gear in time reduces fuel consumption and noise.

Displays on screen



Fig. 37 A: bonnet open; B: rear lid open; C: front left door open; D: rear right door open (4-door vehicles only)

A variety of information can be viewed on the instrument panel display ⇒ Fig. 36 ③, depending on the vehicle equipment:

- Bonnet, rear lid and doors open ⇒ Fig. 37.
- Information and warning texts
- Mileage
- Time
- Navigation instructions
- Outside temperature
- Compass
- Selector lever position ⇒ page 154
- Recommended gear (manual gearbox) ⇒ page 68
- Multifunction display (MFD) and menus with different setting options ⇒ page 73.
- Service interval display ⇒ page 65
- Second speed display ⇒ page 73
- Speed warning function ⇒ page 149
- Start-Stop system status display ⇒ page 149
- Identifying letters on engine (MKB)

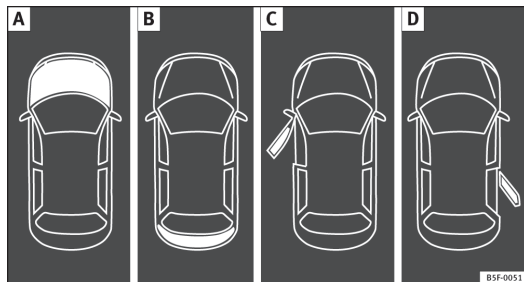

Bonnet, rear lid and doors open

When the ignition is switched on or when driving, the bonnet, rear lid or doors that are open will be indicated on the instrument panel display, and if it should be the case, this will also be indicated audibly. The display may vary according to the type of instrument panel fitted. ▶

Illustration	Key to ⇒ Fig. 37	See
A	 Do not continue driving! The bonnet is open or is not properly closed.	⇒ page 209
B	 Do not continue driving! The rear lid is open or is not properly closed.	⇒ page 98
C, D	 Do not continue driving! A vehicle door is open or is not properly closed.	⇒ page 86

Warning and information texts



The system runs a check on certain components and functions when the ignition is switched on and while the vehicle is moving. Faults in the operation are displayed on the screen using red and yellow symbols and messages on the instrument panel display (⇒ page 69) and, in some cases, with audible warnings. The display may vary according to the type of instrument panel fitted.

Type of message	Symbol colour	Description
Priority 1 warning.	Red	Symbol flashing or lit; partly combined with audible warnings.  Stop the vehicle! It is dangerous ⇒  ! Check the function that is faulty and repair it. If necessary, request assistance from specialised personnel.
Priority 2 warning.	Yellow	Symbol flashing or lit; partly combined with audible warnings. A faulty function, or fluids which are below the correct levels may cause damage to the vehicle! ⇒  Check the faulty function as soon as possible. If necessary, request assistance from specialised personnel.
Informative text.	–	Information relating to different vehicle processes.



Mileage

The *odometer* registers the total distance travelled by the car.

The *odometer (trip)* shows the distance travelled since the last odometer reset. The last digit of the trip recorder indicates distances of 100 metres or one tenths of a mile.

- Briefly press the button ⇒ Fig. 36  to reset the trip recorder to 0.
- Keep the button  pressed for about 3 seconds and the previous value will be displayed.

Time

- To set the time, keep the button ⇒ Fig. 36  pressed for more than 3 seconds to select the hour or minute display.
- To continue setting the time, press the upper or lower part of the button . Hold button down to scroll through the numbers quickly.
- Press the button  again in order to finish setting the time. ▶

The time can also be set via the **CAR** key and **Setup** function button in the Easy Connect system ⇒ page 79.

Outside temperature display

When the outside temperature is below +4 °C (+39 °F), the symbol “ice crystal” (warning of risk of freezing) is also displayed next to the temperature. At first this symbol flashes and then it remains lit until the outside temperature rises above +6 °C (+43 °F) ⇒ .

When the vehicle is at a standstill or when travelling at very low speeds, the temperature displayed may be higher than the true outside temperature as a result of the heat produced by the engine.

The temperatures measured range from -40 °C to +50 °C (-40 °F to +122 °F).

Compass

With the ignition on and the navigation system on, the cardinal point corresponding to the direction of travel of the vehicle is displayed on the instrument panel.

Selector lever positions

The selected gear is displayed on the side of the selector lever and on the instrument panel display. In positions **D** and **S**, and with the Tiptronic, the corresponding gear is also displayed.

Recommended gear (manual gearbox)

The recommended gear in order to save fuel is displayed on the instrument panel while you are driving ⇒ page 68.

Second speed display (mph or km/h)

In addition to the speedometer, the speed can also be displayed in a different unit of measurement (in miles or in km per hour).

This option cannot be deactivated in models destined for countries in which the second speed must always be visible.

The second speed display can be adjusted in the Easy Connect system via the **CAR** key and the **Setup** function button ⇒ page 79.

Speed warning

When the speed setting is exceeded, this will be indicated on the instrument panel display. This is very useful, for example when using winter tyres that are not designed for driving at the maximum speed of the vehicle ⇒ page 149.

The speed warning settings can be adjusted in the Easy Connect system via the **CAR** key and the **Setup** function button ⇒ page 79.

Start/Stop operating display

Updated information relating to the status is displayed on the instrument panel ⇒ page 149.

Identifying letters on engine (MKB)

Hold the button ⇒ Fig. 36  down for more than 15 seconds to display the identifying letters of the vehicle engine (MKB). To do this, the ignition must be switched on and the engine switched off.

WARNING

If the warning lamps and messages are ignored, the vehicle may stall in traffic, or may cause accidents and severe injuries.

- Never ignore the warning lamps or text messages.
- Stop the vehicle safely as soon as possible.
- A faulty vehicle represents a risk of accident for the driver and for other road users. If necessary, switch on the hazard warning lamps and put out the warning triangle to advise other drivers.
- Park the vehicle away from the traffic, ensuring that there are no easily inflammable materials under the vehicle which could come into contact with the exhaust system (e.g. dry grass, fuel).

 **WARNING**

Although the outside temperature is above freezing, some roads and bridges may be frozen.

- At an outside temperature of above +4 °C (+39 °F), even when the "ice crystal" is not visible, there may still be ice on the road.
- Never rely on the outside temperature indicator!

**CAUTION**

Failure to heed the control lamps and text messages when they appear may result in faults in the vehicle.

**Note**

- Different versions of the instrument panel are available and therefore the versions and instructions on the display may vary. In the case of displays without warning or information texts, faults are indicated exclusively by the warning lamps.
- Depending on the equipment, some settings and instructions can also be carried out in the Easy Connect system.
- When several warnings are active at the same time, the symbols are shown successively for a few seconds. The symbols will stay on until the fault is rectified.

Service interval display

The inspection message appears on the instrument panel display
⇒ Fig. 36 (4).

SEAT makes a difference between services *with* engine oil change (Interval Service) and services *without* engine oil change (Inspection Service). The service interval display only gives information for service dates which involve an engine oil change. The dates of the remaining services (for exam-

ple, the next Inspection Service or change of brake fluid) are listed on the label attached to the door strut, or even in the Maintenance Programme.

In vehicles with **Services established by time or mileage**, the service intervals are already pre-defined.

In vehicles with **LongLife Service**, the intervals are determined individually. Technical progress has made it possible to considerably reduce servicing requirements. The technology used by SEAT ensures that your vehicle only has an Interval Service when it is necessary. To establish when the Interval Service is due (max. 2 years), the vehicle's conditions of use and individual driving styles are considered. The service pre-warning first appears 20 days before the date established for the corresponding service. The kilometres remaining until the next service are always rounded up to the nearest 100 km (miles) and the remaining time is given in complete days. The current service message cannot be viewed until 500 km (miles) after the last service. Prior to this only lines are visible on the display.

Inspection reminder

When the Service date is approaching, when the ignition is switched on a **Service reminder** is displayed.

In *vehicles without text messages*, a spanner is displayed on the instrument panel  with a figure given in **km**. The number of kilometres shown is the maximum number that may be driven until the next service. After a few seconds, the display mode changes. A clock symbol appears and the number of days until the next service appointment is due.

In *vehicles with text messages*, **Service in --- km (miles) or --- days** is displayed on the instrument panel.

Service due

After **the service date**, an audible warning is given when the ignition is switched on and the spanner displayed on the screen flashes for a few seconds . In *vehicles with text messages*, **Service in --- km or --- days** is displayed on the instrument panel. ▶

Reading a service notification

With the ignition switched on, the engine off and the vehicle at a standstill, the current **service notification** can be read:



Press and hold the button \Rightarrow Fig. 36  for more than 5 seconds to consult the service message.

When the **service date has past**, a minus sign is displayed in front of the number of kilometres or days. In *vehicles with text messages* the following is displayed: **Service --- km (miles) or --- days ago**.

The time can also be set via the  key and  function button in the Easy Connect system \Rightarrow page 79.



The service interval display is reset

If the service was not carried out by a SEAT dealership, the display can be reset as follows:

- To reset the service interval display, turn the ignition off and press and hold the button \Rightarrow Fig. 36 .
- Switch the ignition back on.
- Release the button  and press the button  again for the next 20 seconds.



Note

- The service message disappears after a few seconds, when the engine is started or when  is pressed on the windscreen wiper lever, or  on the multifunction steering wheel.
- In vehicles with the LongLife system in which the battery has been disconnected for a long period of time, it is not possible to calculate the date of the next service. Therefore the service interval display may not be correct. In this case, please check the maximum permitted service intervals \Rightarrow Booklet Maintenance Programme. ■

Rev counter

The rev counter indicates the number of engine revolutions per minute.

Together with the gear-change indicator, the rev counter offers you the possibility of using the engine of your vehicle at a suitable speed.

The start of the red zone on the dial indicates the maximum engine speed which may be used briefly when the engine is warm and after it has been run in properly. Before reaching this range, you should change to a higher gear for vehicles with a manual gearbox or for automatic gearboxes put the selector lever in “D” or take your foot off the accelerator pedal.

We recommend that you avoid high revs and that you follow the recommendations on the gear-change indicator. Consult the additional information in \Rightarrow page 68, Gear-change indicator.



CAUTION

Never allow the rev counter needle  \Rightarrow Fig. 36 to go into the red zone on the scale for more than a very brief period, otherwise, there is a risk of engine damage.



For the sake of the environment

Changing up a gear early will help you to save fuel and minimise engine noise. ■

Trip recorder

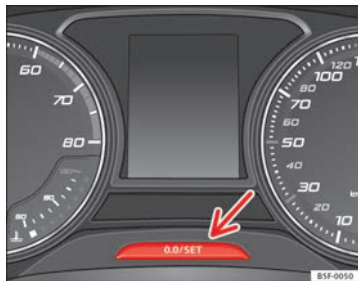

Fig. 38 Instrument panel: Odometer and reset button

The distance covered is displayed in “kilometres” or miles “m”. It is possible to change the measurement units (kilometres “km”/miles “m”) in the radio/Easy Connect*. Please refer to the Easy Connect* Instruction Manual for more details.

Odometer/trip recorder

The odometer shows the total distance covered by the vehicle.

The trip recorder shows the distance that has been travelled since it was last reset. It is used to measure short trips. The last digit of the trip recorder indicates distances of 100 metres or one tenths of a mile.

The trip recorder can be set to zero by pressing **0.0/SET** ⇒ Fig. 38.

Fault display

If there is a fault in the instrument panel, the letters **DEF** will appear in the trip recorder display. Have the fault repaired immediately, as far as is possible.

Fuel level

The display ⑥ ⇒ Fig. 36 only works when the ignition is switched on. When the display reaches the reserve mark, the lower diode lights up in red and the control lamp  appears ⇒ page 207. When the fuel level is very low, the lower diode flashes in red.

The distance to empty fuel level is displayed on the instrument panel ③ ⇒ Fig. 36.

The capacity of the fuel tank of your vehicle is given in the Technical data section ⇒ page 276.

! CAUTION

Never run the fuel tank completely dry. An irregular fuel supply could cause misfiring. In this way the fuel can arrive without burning the exhaust system, which could cause the catalytic converter to overheat resulting in damage.

Coolant temperature gauge

For vehicles with no coolant temperature gauge, a control lamp appears for high coolant temperatures  ⇒ page 215. Take into account the ⇒ ⑩.

The coolant temperature gauge ② ⇒ Fig. 36 only works when the ignition is switched on. In order to avoid engine damage, please read the following notes for the different temperature ranges.

Engine cold

If only the diodes in the lower part of the scale light up, this indicates that the engine has not yet reached operating temperature. Avoid high revs and heavy acceleration and do not make the engine work hard.

Normal temperature

If in normal operations, the diodes light up until the central zone, it means that the engine has reached operating temperature. At high outside temperatures and when making the engine work hard, the diodes may continue lighting up and reach the upper zone. This is no cause for concern, provided the control lamp \perp does not light up on the instrument panel digital display.

Heat range

When the diodes light up in the upper area of the display and the control lamp appears \perp on the instrument panel display, the coolant temperature is excessive \Rightarrow page 215.



CAUTION

- To ensure a long useful life for the engine, avoid high revs, driving at high speed and making the engine work hard for approx. the first 15 minutes when the engine is cold. The phase until the engine is warm also depends on the outside temperature. If necessary, use the engine oil temperature* as a guide \Rightarrow page 77
- Additional lights and other accessories in front of the air inlet reduce the cooling effect of the coolant. At high outside temperatures and high engine loads, there is a risk of the engine overheating.
- The front spoiler also ensures proper distribution of the cooling air when the vehicle is moving. If the spoiler is damaged this can reduce the cooling effect, which could cause the engine to overheat. Seek specialist assistance.

Gear-change indicator

This additional indicator function can help to save fuel.

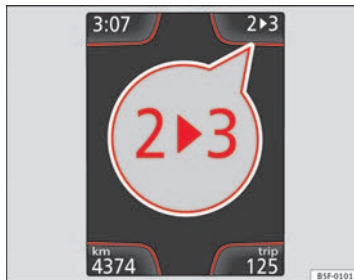

Fig. 39 Instrument panel: Gear-change indicator (manual gearbox)

To familiarise yourself with the gear-change indicator, we recommend driving in the normal way to start with. A gear change will be recommended if the gear you are in is not the most economical choice.

If no gear-change is recommended, you are already in the most economical gear.

Vehicles with a manual gearbox

The following display symbols \Rightarrow Fig. 39 mean:

- **► Change to a higher gear:** The suggested gear appears to the **right** of the current gear when a **higher gear** is recommended.
- **◄ Change to a lower gear:** The suggested gear appears to the **left** of the current gear when a **lower gear** is recommended.

The gear recommendation may occasionally skip a gear (2nd ► 4th). ▶

Vehicles with an automatic gearbox*

The display is only visible in tiptronic mode ⇒ page 159

The following display symbols mean:

- ↑ Shifting up a gear
- ↓ Shifting down a gear

**CAUTION**



The gear-change indicator is intended to help save fuel. It is not intended to recommend the right gear for all driving situations. In certain situations, only the driver can choose the correct gear (for instance when overtaking, driving up a steep gradient or towing a trailer).

**Note**

The display disappears from the instrument panel when you press the clutch pedal.

Control lamps

Control and warning lamps









The control and warning lamps are indicators of warnings, ⇒ , faults ⇒  or certain functions. Some control and warning lamps come on when the ignition is switched on, and switch off when the engine starts running, or while driving.



Depending on the model, additional text messages may be viewed on the instrument panel display. These may be purely informative or they may be advising of the need for action ⇒ page 61, Instruments.

Depending upon the equipment fitted in the vehicle, instead of a warning lamp, sometimes a symbol may be displayed on the instrument panel.

When certain control and warning lamps are lit, an audible warning is also heard.









Red symbols















Symbol	Meaning ⇒ 	See
	Central warning lamp: additional information on the instrument panel display	–
	Symbol on the instrument panel display: Do not continue driving! With the corresponding indication: door(s), rear lid or bonnet open or not properly closed.	⇒ page 86 ⇒ page 98 ⇒ page 209
	Parking brake on.	⇒ page 147
	Do not continue driving! The brake fluid level is too low or there is a fault in the brake system.	⇒ page 185
	<i>Lit up on instrument panel display:^{a)}</i> Do not continue driving! Engine coolant level too low, coolant temperature too high <i>Flashing on the instrument panel display:^{a)}</i> Fault in the engine coolant system.	⇒ page 215
	<i>On the instrument panel display:^{a)}</i> Do not continue driving! Engine oil pressure too low.	⇒ page 211
	<i>Lit up or flashing:</i> Do not continue driving! Fault in the steering.	⇒ page 186
	Driver or passenger has not fastened seat belt.	⇒ page 19

Symbol	Meaning ⇒ 	See
	Use the foot brake!	
	<i>On the instrument panel display:</i> ^{a)} Fault in the battery.	⇒ page 217

a) Colour presentation on instrument panel with colour display.

Yellow symbols

Symbol	Meaning ⇒ 	See
	Central warning lamp: additional information on the instrument panel display	–
	Front brake pads worn.	
	<i>lights:</i> Fault in the ESC, or disconnection caused by the system. <i>flashes:</i> ESC or ASR activated.	⇒ page 183
	ASR manually deactivated.	
	ABS faulty or does not work.	
	Rear fog light switched on.	⇒ page 106
	<i>On the instrument panel display:</i> ^{a)} Driving light totally or partially faulty.	⇒ page 252
	<i>On the instrument panel display:</i> ^{a)} Fault in the cornering light system.	⇒ page 106

Symbol	Meaning ⇒ 	See
	<i>Lights up or flashes:</i> Fault in the emission control system.	
	<i>lights:</i> pre-ignition of diesel engine. <i>flashes:</i> Fault in engine management.	⇒ page 190
EPC	Fault in engine management.	
	<i>On the instrument panel display:</i> ^{a)} Diesel particulate filter blocked.	
	<i>Lights up or flashes:</i> Fault in the steering system.	⇒ page 143
	Tyre pressure too low, or fault in the tyre pressure monitoring system.	⇒ page 175
	<i>On the instrument panel display:</i> ^{a)} Level of windscreen washer fluid too low.	⇒ page 116
	Fuel tank almost empty.	⇒ page 207
	<i>Flashing on the instrument panel display:</i> ^{a)} Fault in the oil level detection. Control manually. <i>Lit up on the instrument panel display:</i> ^{a)} Engine oil level insufficient.	⇒ page 211
	Fault in airbag system and seat belt tensioners.	
OFF 	Front passenger front airbag is off (PASSENGER AIRBAG OFF ).	⇒ page 30
ON 	Front passenger front airbag is on (PASSENGER AIRBAG ON ).	

Symbol	Meaning ⇒	See
	Lane Assist is switched on, but not active.	⇒ page 168
	<i>On the instrument panel display:</i> ^{a)} Fault in the gearbox.	⇒ page 162

a) Colour presentation on instrument panel with colour display.

Other control lamps

Symbol	Meaning ⇒	See
	Left or right turn signal.	⇒ page 106
	Hazard warning lights on.	⇒ page 110
	Trailer turn signals	⇒ page 194
	<i>lights:</i> Press the foot brake! <i>flashes:</i> The selector lever locking button has not engaged.	⇒ page 154
	The vehicle is stopped by engine braking.	
	<i>lights:</i> Cruise control operating.	
	<i>lights:</i> Speed limiter switched on and active. <i>flashes:</i> The speed set by the speed limiter has been exceeded.	⇒ page 164
	Lane Assist is switched on and active.	⇒ page 168
	Main beam on or flasher on.	
	<i>On the instrument panel display:</i> Light Assist switched on.	⇒ page 106
SAFE	<i>On the instrument panel display:</i> Immobiliser active.	

Symbol	Meaning ⇒	See
	<i>On the instrument panel display:</i> Service interval display.	⇒ page 65
	<i>On the instrument panel display:</i> Mobile telephone is connected via Bluetooth to the original telephone device.	⇒ Book-let Bluetooth System
	<i>On the instrument panel display:</i> Mobile telephone battery charge meter. Available only for pre-installed factory-fitted devices.	
	<i>On the instrument panel display:</i> Ice warning. The outside temperature is lower than +4 °C (+39 °F).	⇒ page 64
	<i>On the instrument panel display:</i> Start-Stop system active.	
	<i>On the instrument panel display:</i> Start-Stop system not available.	⇒ page 149
	<i>On the instrument panel display:</i> Engine running.	

WARNING

If the warning lamps and messages are ignored, the vehicle may stall in traffic, or may cause accidents and severe injuries.

- Never ignore the warning lamps or text messages.
- Stop the vehicle safely as soon as possible.
- Park the vehicle away from the traffic, ensuring that there are no easily inflammable materials under the vehicle which could come into contact with the exhaust system (e.g. dry grass, fuel).
- A faulty vehicle represents a risk of accident for the driver and for other road users. If necessary, switch on the hazard warning lamps and put out the warning triangle to advise other drivers.

 **WARNING (Continued)**

- Before opening the bonnet, switch off the engine and allow it to cool.
- In any vehicle, the engine compartment is a hazardous area and could cause severe injuries ⇒ page 209.

**CAUTION**

Failure to heed the control lamps and text messages when they appear may result in faults in the vehicle. ■

Driver information system

Information system

Introduction

With the ignition switched on, it is possible to read the different functions of the display by scrolling through the menus.

In vehicles with multifunction steering wheel, the multifunction display can only be operated with the multifunction steering wheel buttons.

The number of menus displayed on the instrument panel will vary according to the vehicle electronics and equipment.

A specialised workshop will be able to programme or modify additional functions, according to the vehicle equipment. SEAT recommends visiting a SEAT Official Service.

Some menu options can only be read when the vehicle is at a standstill.

As long as a priority 1 warning is displayed, it will not be possible to read the menus. Some warning messages can be confirmed and made to disappear with the windscreen wiper lever button or the multifunction steering wheel button.

Additional information and warnings:

- Easy Connect system ⇒ page 79
- Driver assistance systems ⇒ page 164
- Radio or navigation system ⇒ Booklet Radio or ⇒ Booklet Navigation system



WARNING

Any distraction may lead to an accident, with the risk of injury.

- Do not read the instrument panel display menus when driving.

Overview of the menu structure

Driving data ⇒ page 75

- Vehicle status
- MFD from departure
- MFD from refuelling
- MFD total calculation

Assist systems ⇒ table on page 75

- Activate/deactivate Lane Assist
- Reverse (optional)

Navigation ⇒ Booklet Navigation system

Audio ⇒ Booklet Radio or ⇒ Booklet Navigation system

Telephone ⇒ Booklet Bluetooth system

Vehicle ⇒ table on page 75

Operating the instrument panel menus



Fig. 40 Vehicles without multifunction steering wheel: Button ① on the windscreen wiper lever to confirm the menu options and rocker switch ② to change menu

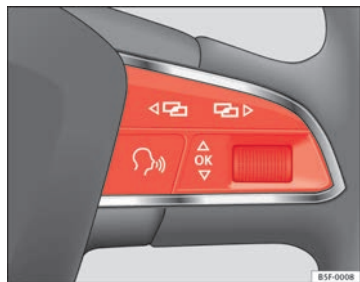







Fig. 41 Right side of multifunction steering wheel: buttons to access the instrument panel menus

Enabling the main menu

- Switch the ignition on.
- If a message or vehicle pictogram appears, press button ⇒ Fig. 40 ① on the windscreen wiper lever or button  on the multifunction steering wheel ⇒ Fig. 41.

- If managed from the windscreen wiper lever: To display the main menu ⇒ page 75 or to return to the main menu from another menu, hold the rocker switch down ⇒ Fig. 40 ②.
- If managed from the multifunction steering wheel: the main menu list is not displayed. To go from point to point in the main menu, press button  or  several times ⇒ Fig. 41.

Select a submenu

- Press the rocker switch ⇒ Fig. 40 ② on the windscreen wiper lever up or down or turn the thumbwheel of the multifunction steering wheel ⇒ Fig. 41 until the desired option appears marked on the menu.
- The selected option is displayed between two horizontal lines. In addition, a triangle is displayed on the right: .
- To consult the submenu option, press button ⇒ Fig. 40 ① on the windscreen wiper lever or button  on the multifunction steering wheel ⇒ Fig. 41.

Making changes according to the menu

- With the rocker switch on the windscreen wiper lever or the thumbwheel of the multifunction steering wheel, make the desired changes. To increase or decrease the values more quickly, turn the thumbwheel faster.
- Mark or confirm the selection with button ⇒ Fig. 40 ① on the windscreen wiper lever or button  on the multifunction steering wheel ⇒ Fig. 41.

Multifunction display memory

The multifunction display is equipped with three memories that work automatically: MFD from departure, MFD from refuelling, MFD total calculation. On the screen display, you can read which memory is currently displayed.

To change between memories with the ignition on and the memory shown, press the button **OK/RESET** on the windscreen wiper lever or you can also change between memories using the button **OK** on the multifunction steering wheel.

Menu	Function
MFD from departure	Display and storage of the values for the journey and the consumption from when the ignition is switched on to when it is switched off. If the journey is continued in less than 2 hours after the ignition is switched off, the new data is added to the data already stored in the memory. The memory will automatically be deleted if the journey is interrupted for more than two hours.
MFD from refuelling	Display and storage of the values for the journey and the consumption. By refuelling, the memory will be erased automatically.
MFD total calculation	The memory records the values for a specific number of partial trips, up to a total of 19 hours and 59 minutes or 99 hours and 59 minutes, or 1999.9 km (or miles) or 9999 km (or miles), depending on the model of instrument panel. On reaching either of these limits ^{a)} , the memory is automatically erased and starts to count from 0 again.

^{a)} It varies according to the type of instrument panel fitted.

Erasing a memory manually

- Select the memory that you wish to erase.
- Press and hold the button **OK/RESET** on the windscreen wiper lever or the button **OK** on the multifunction steering wheel for about 2 seconds.

Personalising the displays

In the Easy Connect system you can adjust which of the possible displays of the MFD can be shown on the instrument panel display with the button **CAR** and the function button **Setup** ⇒ page 79.

Displays	
Menu	Function
Current fuel consumption	The current fuel consumption display operates throughout the journey, in litres/100 km; and with the engine running and the vehicle stopped, in litres/hour.
Average fuel consumption	After turning on the ignition, average fuel consumption in litres/100 km will be shown after travelling approximately 100 metres. Otherwise horizontal lines are displayed. The value shown is updated approximately every 5 seconds.
Operating range	Approximate distance in km that can still be travelled with the fuel remaining in the tank, assuming the same style of driving is maintained. This is calculated using the current fuel consumption.
Journey duration	This indicates the hours (h) and minutes (min) since the ignition was switched on.
Distance covered	Distance covered in km (m) after switching on the ignition.
Average speed	The average speed will be shown after a distance of approximately 100 metres has been travelled. Otherwise horizontal lines are displayed. The value shown is updated approximately every 5 seconds.
Digital display of speed	Current speed displayed in digital format.
Speed warning at --- km/h or Speed warning at --- mph	If the stored speed is exceeded (between 30 - 250 km/h, or 1 - 155 mph), an audible warning is given together with a visual warning. ▶

Displays	
Menu	Function
Oil temperature	Updated engine oil temperature digital display
Coolant temperature gauge	Digital display of the current temperature of the liquid coolant.

Storing a speed for the speed warning

- Select the display **Speed warning at --- km/h (--- mph)**
- Press the button **OK/RESET** on the windscreen wiper lever or the button **OK** on the multifunction steering wheel to store the current speed and activate the warning.
- If necessary, adjust the desired speed within 5 seconds using the rocker switch **TRIP** on the windscreen wiper lever or by turning the thumbwheel on the multifunction steering wheel. Next, press the button **OK/RESET** or **OK** again or wait several seconds. The speed is stored and the warning activated.
- *To deactivate it* press the button **OK/RESET** or the button **OK**. The stored speed is deleted.

Assist systems submenu

Assist systems menu	Function
Lane Assist*	Switching the Lane Assist system on or off ⇒ page 170.
Tiredness detection*	Switching the tiredness detection on or off (pause recommendation) ⇒ page 173.

Personal convenience settings

When two people use a vehicle, SEAT recommends that each person always uses their own remote control key. When the ignition is switched off, or the

vehicle is locked, the convenience settings are stored and allocated to the vehicle key ⇒ page 73.

The values of the personalised convenience settings are allocated to the vehicle key in the Easy Connect system via the button **CAR** and the function button **Setup** ⇒ page 79:

Vehicle settings menu

- Time
- Language
- Units

Convenience settings menu

- Door unlock (individual opening, Auto Lock)
- Convenience handling of windows
- Rear vision mirror adjustment

Light settings menu

- Coming home and leaving home
- Footwell light
- Convenience turn signals

The stored settings are automatically activated, at the latest when the ignition is switched on.



Engine oil temperature display

Vehicles without multifunction steering wheel



- To display the temperature of the engine oil, press the rocker switch ⇒ Fig. 40 ② until the main menu appears. Enter into **Journey data**. With the button ② move to the oil temperature gauge.

Vehicles with multifunction steering wheel

- To display the engine oil temperature, enter the submenu **Journey data** and turn the thumbwheel until the oil temperature display appears.

The engine reaches its operating temperature when in normal driving conditions, the oil temperature is between **80 °C (180 °F)** and **120 °C (250 °F)**. If the engine is required to work hard and the outside temperature is high, the engine oil temperature can increase. This does not present any problem as long as the warning lamps  ⇒ page 69 or  ⇒ page 70 do not appear on the display. ■

Additional electrical appliances

- Operation with the windscreen wiper lever*: Press the rocker switch ⇒ Fig. 40  until the main menu appears. Enter into the section **Journey data**. With the rocker switch, move to the display **Convenience appliances**.
- Operation with the multifunction steering wheel*: Move with the buttons  or  to **Journey data** and enter with **OK**. Turn the thumbwheel to the right until the **Convenience appliances** display appears.

In addition, a scale will inform you of the current sum of all the additional appliances. ■

Saving tips

Tips on how to save fuel will be displayed in certain conditions that contribute to increased consumption. Following these tips could

reduce the fuel consumption of your vehicle. The displays appear automatically and will only be shown with the efficiency programme. After a time, the saving tips will disappear automatically.

- If you wish to hide a saving tip immediately after it appears, press any button on the windscreen wiper lever*/multifunction steering wheel*.





Note

- If you hide a saving tip, it will reappear after you switch the ignition on again.
- The saving tips do not appear in all situations, but rather with a large separation of time. ■

Introduction to the Easy Connect system*

System settings (CAR)*

Introduction

To select the settings menus, press the Easy Connect  button and the  function button.

The actual number of menus available and the name of the various options in these menus will depend on the vehicle's electronics and equipment.



Additional information and warnings:

- Driver assistance systems ⇒ page 164

WARNING

Any distraction may lead to an accident, with the risk of injury. Operating the Easy Connect system while driving could distract you from traffic.

CAR menu (Setup) settings

- Switch the ignition on.
- Switch on the Easy Connect system.
- Press the Easy Connect button .
- Press the  function button to open the main **Vehicle settings menu**.

Pressing the menu button will always take you to the last menu used.

Function buttons in the vehicle's settings menu	Page
ESC system	⇒ page 79
Tyres	⇒ page 80
Driver assistance	⇒ page 80
Parking and manoeuvring	⇒ page 81
Vehicle lights	⇒ page 81
Rear vision mirrors and windscreen wipers	⇒ page 82
Opening and closing	⇒ page 82
Multifunction display	⇒ page 83
Date and time	⇒ page 84
Units	⇒ page 84
Service	⇒ page 85
Factory settings	⇒ page 85

Any changes made using the settings menus are automatically saved on closing those menus.

WARNING

Any distraction may lead to an accident, with the risk of injury. Operating the Easy Connect system while driving could distract you from traffic.

ESC System menu

- Switch the ignition on. ▶

- Switch on the Easy Connect system.
- Press the Easy Connect button **CAR**.
- Press the **Setup** function button.
- Press the **ESC System** function button to make changes to the Electronic Stability Programme (ESC).

When the menu appears, choose the desired option.

Pressing the menu button **☰** will always take you to the last menu used.

Menu	Submenu	Possible setting	Description
Vehicle settings	–	Activation of the Electronic Stability Programme (ESC)	⇒ page 183

Any changes made using the settings menus are automatically saved on closing those menus.

WARNING

Any distraction may lead to an accident, with the risk of injury. Operating the Easy Connect system while driving could distract you from traffic. ■

Tyre Settings menu

- Switch the ignition on.
- Switch on the Easy Connect system.
- Press the Easy Connect button **CAR**.
- Press the **Setup** function button.

- Press the **Tyre** button to open the **Tyre settings** menu.

When the function button check box is activated , the function is active.

Pressing the menu button **☰** will always take you to the last menu used.

Menu	Submenu	Possible setting	Description
Tyre settings	Tyre pressure monitoring	Tyre pressure storing (Calibration)	⇒ page 175
	Winter tyres	Speed warning activation and deactivation Change the speed warning value	⇒ page 149

Any changes made using the settings menus are automatically saved on closing those menus.

WARNING

Any distraction may lead to an accident, with the risk of injury. Operating the Easy Connect system while driving could distract you from traffic. ■

Driver Assistance settings menu

- Switch the ignition on.
- Switch on the Easy Connect system.
- Press the Easy Connect button **CAR**.
- Press the **Setup** function button. ▶

- Press the **Driver assistance** function button to open the **Driver assistance** settings menu.

When the function button check box is activated , the function is active.

Pressing the menu button  will always take you to the last menu used.

Menu	Submenu	Possible setting	Description
Driver Assistance settings	Lane Assist (system warning you if you leave the lane)	Lane Centring Assist	⇒ page 168
	Tiredness detection	Activation	⇒ page 173

Any changes made using the settings menus are automatically saved on closing those menus.

WARNING

Any distraction may lead to an accident, with the risk of injury. Operating the Easy Connect system while driving could distract you from traffic.

Parking and Manoeuvring Settings menu

- Switch the ignition on.
- Switch on the Easy Connect system.
- Press the Easy Connect button .
- Press the **Setup** function button.
- Press the **Parking and manoeuvring** button to open the **Parking and manoeuvring settings** menu.

When the function button check box is activated , the function is active.

Pressing the menu button  will always take you to the last menu used.

Menu	Submenu	Possible setting	Description
Parking and Manoeuvring settings	ParkPilot	Automatically activate, front volume, front sound settings, rear volume, rear sound settings, adjust volume.	⇒ page 178

Any changes made using the settings menus are automatically saved on closing those menus.

WARNING

Any distraction may lead to an accident, with the risk of injury. Operating the Easy Connect system while driving could distract you from traffic.

Light Settings menu

- Switch the ignition on.
- Switch on the Easy Connect system.
- Press the Easy Connect button .
- Press the **Setup** function button.
- Press the **Lights** function button to open the **Light settings** menu.

When the function button check box is activated , the function is active. ▶

Pressing the menu button  will always take you to the last menu used.

Menu	Submenu	Possible setting	Description
Light settings	Light Assist	Light Assist, sensitivity, automatic light when raining, daytime driving lights, convenience turn signals.	⇒ page 111
	Vehicle interior lighting	Instrument and control lighting, ambient door lighting, footwell lighting.	⇒ page 114
	"Coming home"/"Leaving home" function	Start time for "Coming home" function, start time for "Leaving home" function.	⇒ page 113



Any changes made using the settings menus are automatically saved on closing those menus.



WARNING

Any distraction may lead to an accident, with the risk of injury. Operating the Easy Connect system while driving could distract you from traffic. ■

Rear Vision Mirror and Windscreen Wipers Settings menu

- Switch the ignition on.
- Switch on the Easy Connect system.
- Press the Easy Connect button .
- Press the  function button.

- Press the  function button to open the **Visibility settings** menu.

When the function button check box is activated , the function is active.

Pressing the menu button  will always take you to the last menu used.

Menu	Submenu	Possible setting	Description
Visibility settings	Rear vision mirrors	Synchronised regulation, lower when reversing, fold in after parking.	⇒ page 122
	Windscreen wipers	Automatic windscreen wipers, wipe when reversing.	⇒ page 116



Any changes made using the settings menus are automatically saved on closing those menus.



WARNING

Any distraction may lead to an accident, with the risk of injury. Operating the Easy Connect system while driving could distract you from traffic. ■

Opening and Closing Settings menu

- Switch the ignition on.
- Switch on the Easy Connect system.
- Press the Easy Connect button .
- Press the  function button. ▶

- Press the **Opening and closing** function button to open the **Opening and closing settings** menu.

When the function button check box is activated , the function is active.

Pressing the menu button  will always take you to the last menu used.

Menu	Submenu	Possible setting	Description
Opening and Closing settings	Radio-operated remote control	Convenience open function.	⇒ page 91
	Central locking	Unlocking doors, automatic locking/unlocking, audible confirmation.	⇒ page 86

Any changes made using the settings menus are automatically saved on closing those menus.



WARNING

Any distraction may lead to an accident, with the risk of injury. Operating the Easy Connect system while driving could distract you from traffic.

Multifunction Display settings menu

- Switch the ignition on.
- Switch on the Easy Connect system.
- Press the Easy Connect button .
- Press the **Setup** function button.

- Press the **Multifunction Display** function button to open the **Multifunction Display settings** menu.

When the function button check box is activated , the function is active.

Pressing the menu button  will always take you to the last menu used.

Menu	Submenu	Possible setting	Description
Multifunction display settings	–	Current consumption, average consumption, volume to fill up, convenience equipments, ECOAdvice, duration of journey, distance travelled, digital average speed display, speed, speeding warning, oil temperature, coolant temperature, restore data “from start”, restore “total calculation” data.	⇒ page 73

Any changes made using the settings menus are automatically saved on closing those menus.



WARNING

Any distraction may lead to an accident, with the risk of injury. Operating the Easy Connect system while driving could distract you from traffic.

Date and Time settings menu

The menu options will vary depending on the sound system fitted in the vehicle.

- Switch the ignition on.
- Switch on the Easy Connect system.
- Press the Easy Connect button **CAR**.
- Press the **Setup** function button.
- Press the **Date and time** function button to open the **Date and time settings** menu.

When the function button check box is activated , the function is active.

Pressing the menu button **☰** will always take you to the last menu used.

Menu	Submenu	Possible setting	Description
Date and time settings	–	Time source, set the time, automatic summer time setting, select time zone, time format, set the date, date format.	–

Any changes made using the settings menus are automatically saved on closing those menus.



WARNING

Any distraction may lead to an accident, with the risk of injury. Operating the Easy Connect system while driving could distract you from traffic.

Units Settings menu

- Switch the ignition on.
- Switch on the Easy Connect system.
- Press the Easy Connect button **CAR**.
- Press the **Setup** function button.
- Press the **Measurement Units** function button to open the **Measurement units settings** menu.

When the menu appears, choose the desired option.

Pressing the menu button **☰** will always take you to the last menu used.

Menu	Submenu	Possible setting	Description
Measurements unit settings	Distance	a)	–
	Speed		
	Temperature		
	Volume		
	Fuel consumption		

a) Data not available at the time of going to print



Any changes made using the settings menus are automatically saved on closing those menus.



WARNING

Any distraction may lead to an accident, with the risk of injury. Operating the Easy Connect system while driving could distract you from traffic.

Service information

- Switch the ignition on.
- Switch on the Easy Connect system.
- Press the Easy Connect button .
- Press the  function button.
- Press the  function button to display the information about service inspections.

Pressing the menu button  will always take you to the last menu used.

Menu	Submenu	Possible setting	Description
Service	–	Chassis number, date of next SEAT service inspection, date of next oil change service.	⇒ page 61

WARNING

Any distraction may lead to an accident, with the risk of injury. Operating the Easy Connect system while driving could distract you from traffic.

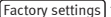
- Press the  function button.
- Press the  function button to open the **Factory settings** menu.

Pressing the menu button  will always take you to the last menu used.

Menu	Submenu	Possible setting	Description
Factory settings	–	All settings, driver assistance, parking and manoeuvring, lights, rear vision mirrors and wind-screen wipers, opening and closing, multifunction display.	–

Any changes made using the settings menus are automatically saved on closing those menus.

WARNING

Any distraction may lead to an accident, with the risk of injury. Operating the Easy Connect system while driving could distract you from traffic.

Restoring default settings

- Switch the ignition on.
- Switch on the Easy Connect system.
- Press the Easy Connect button .

Opening and closing

Central locking system

Description

The vehicle can be locked and unlocked via the central locking system. There are several methods, depending on the vehicle equipment:

- key with remote control ⇒ page 91,
- lock on driver door (emergency opening ⇒ page 97) or
- interior central locking switch ⇒ page 93.

Unlocking one side of the vehicle only

When you lock the vehicle with the key, the doors and the rear lid are locked. When you open the door, you can either unlock *only* the driver door, or all the vehicle doors. To select the required option, use Easy Connect* ⇒ page 92.

Central locking (Auto Lock)

The Auto Lock function locks the doors and the rear lid when the vehicle exceeds a speed of about 15 km/h (10 mph).

The vehicle is unlocked again when the ignition key is removed. Alternatively, the vehicle can also be unlocked via the central locking switch or by pulling one of the inside door handles. The Auto Lock function can be switched on and off on the sound system or on the Easy Connect* system ⇒ page 92.

In the event of an accident in which the airbags inflate, the doors will be automatically unlocked to facilitate access and assistance.

Anti-theft security system (Safelock)¹⁾

The following message is displayed on the instrument panel to remind the driver that when the vehicle is closed from the outside, the anti-theft security system is switched on. **⚠ Do not forget the Safelock. Please see Instruction Manual.** The vehicle cannot be opened from inside. This makes it more difficult for unauthorised persons to break into the vehicle ⇒ **⚠**.

The anti-theft security system can be switched off each time the vehicle is locked:

- Turn the key a second time to the lock position, in the door lock, **for the next two seconds**. If necessary, remove the protective cover on the driver door handle ⇒ page 97. or
- Press **Ⓜ** on the remote control key for a second time **for the following 2 seconds**.

The flashing frequency of the diode in the door sill immediately confirms the process. Initially, the diode flashes in a fast sequence for a brief period, then it stops for approximately 30 seconds and, lastly continues flashing slowly.

Anti-theft alarm system*

If the anti-theft alarm system senses interference with the vehicle it triggers an audible and visible alarm.

The anti-theft alarm system is automatically switched on when locking the vehicle. It switches off when the vehicle is unlocked from a distance.

When the driver door is unlocked with the key, you should switch on the ignition within 15 seconds. Otherwise the alarm will be triggered. On some export versions, the alarm is triggered immediately when you open a door. ►

¹⁾ The availability of this function depends on the vehicle equipment.

To deactivate the alarm, press the button  on the remote control key, or switch on the ignition. After a certain time, the alarm will automatically switch off.

Switch off the vehicle interior monitoring and tow-away protection if you wish to prevent the alarm from being triggered accidentally ⇒ page 95.

Turn signals

The turn signals will flash twice when the vehicle is unlocked and once when the vehicle is locked.

If the signals do not flash, this indicates that one of the doors, the rear lid or the bonnet is not closed correctly.

Accidental lock-out

The central locking system prevents you from being locked out of the vehicle in the following situations:

- If the driver door is open, the vehicle cannot be locked with the central locking switch ⇒ page 93.

Lock the vehicle with the remote control key, when all the doors and the rear lid have been closed. This prevents the accidental locking of the vehicle.



WARNING

Do not leave anyone (especially children) in the vehicle if it is locked from the outside and the anti-theft security system* is enabled, as the doors and windows cannot then be opened from the inside. Locked doors could delay assistance in an emergency, potentially putting lives at risk.



Note

- Never leave any valuable items in the vehicle unattended. Even a locked vehicle is not a safe.
- If the diode on the driver door sill lights up for about 30 seconds when the vehicle is locked, the central locking system or anti-theft alarm* is not working properly. You should have the fault repaired at a SEAT Official Service or specialised workshop.
- The vehicle interior monitoring of the anti-theft alarm* system will only function as intended if the windows and the sunroof* are closed. ■

Vehicle key



Fig. 43 Vehicle key



Fig. 44 Vehicle key with alarm button

Vehicle key

With the vehicle key the vehicle may be locked or unlocked remotely
⇒ page 86.

The vehicle key includes an emitter and battery. The receiver is in the interior of the vehicle. The range of the vehicle key with remote control and new battery is several metres around the vehicle.

If it is not possible to open or close the vehicle using the remote control key, this should be re-synchronised ⇒ page 90 or the battery changed ⇒ page 90.

Different keys belonging to the vehicle may be used.

Unfolding and folding the key shaft

Press button ① ⇒ Fig. 43 or ⇒ Fig. 44 to unlock and unfold the key shaft.

To fold the shaft away, press button ① and fold the key shaft in until it locks in place.

Alarm button¹⁾

Only press alarm button ② in the event of an emergency! When the alarm button is pressed, the vehicle horn is heard and the turn signals are switched on for a short time. When the alarm button is pressed again, the alarm is switched off.

Replacing a key

To obtain a spare key and other vehicle keys, the vehicle chassis number is required.

Each new key contains a microchip which must be coded with the data from the vehicle electronic immobiliser. A vehicle key will not work if it does not contain microchip or the microchip has not been encoded. This is also true for keys which are specially cut for the vehicle.

The vehicle keys or new spare keys can be obtained from a SEAT Official Service, a specialised workshop or an approved key service qualified to create this kind of key.

New keys or spare keys must be synchronised before use ⇒ page 90. ▶

¹⁾ This system is only available in some markets

⚠ CAUTION

All of the vehicle keys contain electronic components. Protect the vehicle keys from damage, impacts and humidity.

ℹ Note

- Only use the key button when you require the corresponding function. Pushing the button unnecessarily could accidentally unlock the vehicle or trigger the alarm. It is also possible even when you are outside the radius of action.
- Key operation can be greatly influenced by overlapping radio signals close the vehicle working in the same range of frequencies, for example, radio transmitters, mobile telephones.
- Obstacles between the remote control and the vehicle, bad weather conditions and discharged batteries can considerably reduce the range of the remote control.
- If buttons ⇒ Fig. 43 or ⇒ Fig. 44 on the vehicle key, or one of the central locking buttons ⇒ page 93 are pressed repeatedly in short succession, the central locking is briefly switched off to protect against overloading. The vehicle is then unlocked. Lock the vehicle if necessary. ■

Control lamp on the vehicle key



Fig. 45 Control lamp on the vehicle key

When a button on the vehicle key is pressed, the control lamp flashes ⇒ Fig. 45 (arrow) once briefly. If the button is pressed and held down, the lamp flashes several times, for example: for the convenience opening function.

If the vehicle key control lamp does not light up when the button is pressed, replace the battery ⇒ page 90. ■

Changing the battery

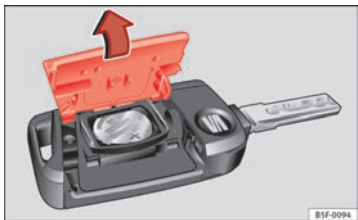

Fig. 46 Vehicle key: opening the battery compartment

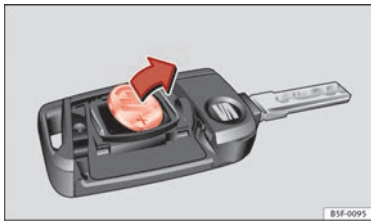

Fig. 47 Vehicle key: removing the battery

SEAT recommends you ask a specialised workshop to replace the battery.

The battery is located to the rear of the vehicle key, under a cover.

Changing the battery

- Unfold the vehicle key shaft ⇒ page 88.
- Remove the cover from the back of the vehicle key ⇒ Fig. 46 in the direction of the arrow ⇒ ①.
- Extract the battery from the compartment using a suitable thin object ⇒ Fig. 47.

- Place the new battery in the compartment as shown ⇒ Fig. 47, pressing in the opposite direction to that shown by the arrow ⇒ ②.
- Fit the cover as shown ⇒ Fig. 46, pressing it onto the vehicle key casing in the opposite direction to that shown by the arrow until it clicks into place.



CAUTION

- If the battery is not changed correctly, the vehicle key may be damaged.
- Use of unsuitable batteries may damage the vehicle key. For this reason, always replace the dead battery with another of the same voltage, size and specifications.
- When fitting the battery, check that the polarity is correct.



For the sake of the environment

Please dispose of your used batteries correctly and with respect for the environment. ■

Synchronising the vehicle key

If the button ④ is pressed frequently outside of the vehicle range, it is possible that the vehicle can no longer be locked or unlocked using the key. In this case, the key must be resynchronised as described below:

- Unfold the vehicle key shaft ⇒ page 88.
- If necessary, remove the cover from the driver door lever ⇒ page 97.
- Press the button ④ on the vehicle key. For this, it must remain with the vehicle.
- Open the vehicle within one minute using the key shift. The key has been synchronised.
- If necessary, fit the cap. ■





Remote unlocking/Locking





Fig. 48 Remote control key: Buttons



Fig. 49 Remote control key: Buttons

- To unlock the vehicle, press the  button ⇒ Fig. 48.
- To lock the vehicle, place the selector lever in position P (automatic gearbox) and press button  ⇒ .
- To lock the vehicle without the anti-theft security system*, press button  again **for the next 2 seconds**.
- To unlock the rear lid, press and hold the button  for at least one second.

The vehicle will be locked again automatically if you do not open one of the doors or the rear lid within 30 seconds after unlocking the car. This function prevents the vehicle from remaining unlocked if the unlocking button is pressed by mistake. This is not valid if the button  is held down for at least one second.

In vehicles with a **security central locking feature** (selective unlocking of side doors) ⇒ page 91, when the button  is pressed once, only the driver door and the fuel tank flap are unlocked. When the button is pressed a second time, all the vehicle doors are unlocked.

WARNING

Do not leave anyone (especially children) in the vehicle if it is locked from the outside and the anti-theft security system* is enabled, as the doors and windows cannot then be opened from the inside. Locked doors could delay assistance in an emergency, potentially putting lives at risk.

Note

- Do not use the remote control key until the vehicle is visible.
- Other functions of the remote control key ⇒ page 101, Convenience opening/closing.

Selective unlocking system

The selective unlocking system allows you to only unlock the driver door and the fuel tank flap. All other doors and the rear lid remain locked.

Unlocking the driver door and tank flap

- Press button  on the remote control key *once*, or turn the key *once* to open. ▶

Unlocking all the doors, the rear lid and the tank flap simultaneously.

- Within 5 seconds, press button  on the remote control key *twice*, or turn the key to open *twice* within 5 seconds.

The anti-theft security system* and the anti-theft alarm* are immediately disabled if you unlock only the driver door, without unlocking the other doors.

In vehicles with Easy Connect*, you can programme the security central locking system directly ⇒ page 92.



Programming the central locking system

You can use Easy Connect* to select which doors are unlocked with the central locking system. Using the radio or the Easy Connect* system, you can select whether the vehicle automatically closes with the “Auto Lock” programme at speeds of more than 15 km/h (10 mph).

Programming the unlocking of the doors (vehicles with Easy Connect)

- Select: control button **Systems** or **Vehicle systems** › **Vehicle settings** › **Central locking** › **Unlocking doors**.

Programming the Auto Lock (vehicles with radio)

- Select:  button › control button  **Central locking** › **Locking while driving**.

Programming the Auto Lock (vehicles with Easy Connect)

- Select: control button **Systems** or **Vehicle systems** › **Vehicle settings** › **Locking while driving**.

Unlocking the doors - You can programme the system to unlock **all** the doors or only the **driver** door when you unlock the vehicle. In **all** the options, the fuel tank flap is also unlocked.

With the setting, **Driver**, all the doors and the rear lid are unlocked if button  on the remote control key is pressed twice.

With this setting, you can continue to unlock all the vehicle doors. To do so, press button  on the remote control key **twice**. Or, in vehicles with a conventional key, turn the key to open in the door lock twice within 2 seconds.

If the button  is pressed, all the vehicle doors are locked. At the same time, a confirmation signal is heard¹⁾.



Auto Lock/Locking while driving - If you select **on**, all the vehicle doors are locked at speeds above 15 km/h (10 mph).

¹⁾ This function is not available on all export versions.

Central locking switch



Fig. 50 Driver door: central locking switch

- To lock the vehicle, press the  button ⇒ .
- To unlock the vehicle, press the  button ⇒ Fig. 50.

Please note the following when using the central locking switch to lock your vehicle:

- It is not possible to open the doors or the rear lid from the *outside* (for safety reasons, e.g. when stopped at traffic lights).
- The LED in the central locking switch lights up when all the doors are closed and locked.
- You can open the doors individually from the inside by pulling the inside door handle.
- In the event of an accident in which the airbags inflate, doors locked from the inside will be automatically unlocked to facilitate access and assistance.

WARNING

- The central locking switch also operates when the ignition is switched off and automatically locks all the vehicle doors when the button  is pressed.
- The central locking switch does not operate if the vehicle is locked from the outside and the anti-theft security system is switched on.
- Locked doors could delay assistance in an emergency, potentially putting lives at risk. Do not leave anyone (especially children) in the vehicle.

Note

The doors and the rear lid are locked automatically when the vehicle reaches a speed of about 15 km/h (10 mph) (Auto Lock) ⇒ page 86. You can unlock the vehicle again using button  on the central locking switch. ■

Anti-theft alarm system

Description

The anti-theft alarm makes it more difficult to break into the vehicle or steal it.

The anti-theft alarm is automatically turned on when the vehicle is locked with the key.

When does the system trigger an alarm?

The anti-theft alarm siren will be triggered for about 30 seconds accompanied by optical warning signals for about five minutes when the vehicle is locked and the following unauthorised actions are taken: ►

- When the door is mechanically unlocked using the vehicle key without turning the ignition within the following 15 seconds.
- A door is opened.
- The bonnet is opened.
- The rear lid is opened.
- When the ignition is switched on with a non-authorized key.
- When the vehicle battery is disconnected.
- Movement inside the vehicle (in vehicles with interior monitoring ⇒ page 95).
- When the vehicle is towed (in vehicles with anti-tow system ⇒ page 95).
- When the vehicle is raised (in vehicles with anti-tow system ⇒ page 95).
- When the vehicle is transported on a ferry or by rail (vehicles with an anti-tow system or vehicle interior monitoring ⇒ page 95).
- When a trailer connected to the anti-theft alarm system is disconnected.

How to turn OFF the alarm

Unlock the vehicle with the unlocking button on the key or turn on the ignition with a valid key.



Note

- The alarm will be triggered once more when anybody enters the same zone of surveillance or any other zone. If, for example, after opening a door, the rear lid is also opened.
- The anti-theft alarm  is not activated when the vehicle is locked from the inside using the central locking button.

- If the driver door is unlocked mechanically with the key, only the driver door is unlocked, the rest of the doors remain locked. Only when the ignition has been turned on will the other doors be available - but not unlocked - and the central lock button activated.
- If the vehicle battery is run down or flat then the anti-theft alarm will not operate correctly. ■



Vehicle interior monitoring and anti-tow system*

Monitoring or control function incorporated in the anti-theft alarm which detects unauthorized vehicle entry by means of ultrasound.*

Activation

- It is automatically switched on when the anti-theft alarm is activated.

Deactivation

- Open the vehicle with the key, either mechanically¹⁾ or by pressing the  button on the remote control.
- Press the button  on the remote control twice. The volumetric sensor and tilt sensors will be deactivated. The alarm system remains activated.

The vehicle interior monitoring and the anti-tow system are automatically switched on again next time the vehicle is locked. ►

¹⁾ The time period from when the door is opened until the key is inserted in the contact should not exceed 15 sec., otherwise the alarm will be triggered.

The vehicle interior monitoring and anti-tow sensor (tilt sensor) are automatically switched on when the anti-theft alarm is switched on. In order to activate it, all the doors and the rear lid must be closed.

If you wish to switch off the vehicle interior monitoring and the anti-tow system, it must be done each time that the vehicle is locked; if not, they will be automatically switched on.

The vehicle interior monitoring and the anti-tow system should be switched off if animals are left inside the locked vehicle (otherwise, their movements will trigger the alarm) or when, for example, the vehicle is transported or has to be towed with only one axle on the ground.

False alarms

The interior monitoring only operates correctly if the vehicle is completely closed. Please observe legal requirements when doing so.

The following cases may cause a false alarm:

- opened windows (partially or fully)
- panoramic/tilting sunroof open (partially or completely).
- movement of objects inside the vehicle, such as loose papers, items hanging from the rear vision mirror (air fresheners), etc.



Note

- If the vehicle is relocked and the alarm is activated without the volumetric sensor function, relocking will activate the alarm with all its functions, except the volumetric sensor. This function is reactivated when the alarm is switched on again, unless it is deliberately switched off.
- If the alarm has been triggered by the volumetric sensor, this will be indicated by a flashing of the warning lamp on the driver door when the vehicle is opened. The flash is different to the flash indicating the alarm is activated.

¹⁾ Only available in certain markets.

- The vibration of a mobile phone left inside the vehicle may cause the vehicle interior monitoring alarm to trigger, as both sensors react to movements and shakes inside the vehicle.
- If on activating the alarm, any door or the rear lid is open, only the alarm will be activated. The vehicle interior monitoring and the anti-tow system will only be activated once all the doors are closed (including the rear lid). ■

Deactivating the vehicle interior monitoring and tow-away protection¹⁾

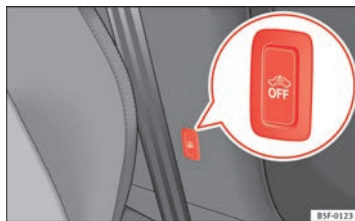

Fig. 51 Vehicle interior monitoring/tow-away protection button

When the vehicle is locked, the alarm will be triggered if movements are detected in the interior (e.g. by animals) or if the vehicle's inclination is changed (e.g. during transport). You can prevent the alarm from being triggered accidentally by switching off the vehicle interior monitoring and/or tow-away protection.

- To switch off the vehicle interior monitoring and tow-away protection, switch off the ignition and press button ⇒ Fig. 51. The button will light up. ▶

- When the vehicle is locked now, the vehicle interior monitoring and the tow-away protection are switched off until the next time the door is opened.

If the anti-theft security system (Safelock)* ⇒ page 86 is switched off, the vehicle interior monitoring and the tow-away protection are automatically switched off.

WARNING

Do not leave anyone (especially children) in the vehicle if it is locked from the outside and the anti-theft security system* is enabled, as the doors and windows cannot then be opened from the inside. Locked doors could delay assistance in an emergency, potentially putting lives at risk. ■

Emergency locking and unlocking

Introduction

The doors, rear lid and panoramic tilting sunroof can be locked manually and partially opened, for example if the key or the central locking is damaged.

Additional information and warnings:

- Vehicle key set ⇒ page 88
- Central locking and locking system ⇒ page 86
- Rear lid ⇒ page 98

WARNING

Opening and closing doors carelessly can cause serious injury.

- If the vehicle is locked from outside, the doors and windows cannot be opened from the inside.
- Never leave children or disabled people alone in the car. They could be trapped in the car in an emergency and will not be able to get themselves to safety.
- Depending on the time of the year, temperatures inside a locked and closed vehicle can be extremely high or extremely low resulting in serious injuries and illness or even death, particularly for young children.

WARNING

Getting in the way of the doors and the rear lid is dangerous and can lead to serious injury.

- Open and close the doors and the rear lid only when there is nobody in the way.

CAUTION

When opening and closing in an emergency, carefully disassemble components and then reassemble them carefully to avoid damage to the vehicle. ■

Unlocking or locking the driver door

If the central locking system should fail to operate, the driver door can still be locked and unlocked by turning the key in the lock.

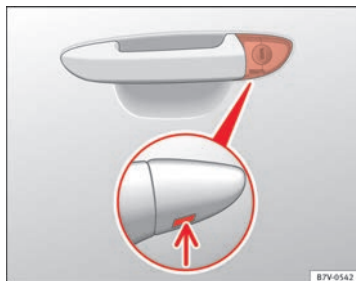

Fig. 52 Driver door lever:
Hidden lock cylinder

As a general rule, when the driver door is locked all other doors are locked. When the vehicle is unlocked manually, only the driver door opens. Please observe the instructions relating to the anti-theft alarm system ⇒ page 86.

- Unfold the vehicle key shaft ⇒ page 88.
- Insert the key shaft into the opening in the cover on the driver door handle from below ⇒ Fig. 52 (arrow) then remove the cover upwards.
- Insert the key shaft into the lock cylinder to unlock or lock the vehicle.

Unlocking notes:

- The anti-theft alarm will remain active when vehicles are unlocked. However, the alarm will not yet be triggered ⇒ page 86.
- After the driver door is opened, you have 15 seconds to switch on the ignition. After 15 seconds, the alarm is triggered.
- Switch the ignition on. When the ignition is switched on, the electronic immobiliser recognises a valid vehicle key and deactivates the anti-theft alarm system.



Note

The anti-theft alarm is not activated when the vehicle is locked manually using the key shaft ⇒ page 86.

Manual locking of passenger door in an emergency

If the central locking system should fail to work at any time, the passenger door will have to be locked separately.



Fig. 53 Locking the door
manually

A mechanical locking device (only visible when the door is open) is provided on the front passenger door.

- Pull the cap out of the opening.
- Insert the key in the inside slot and turn it to the right as far as it will go (if the door is on the right side) or to the left (if the door is on the left side).

Once the door has been closed it can no longer be opened from the outside. Pull the interior door handle once to unlock and open the door. ■

Rear lid (luggage compartment)

Rear lid

The rear lid opening system operates electrically. It is activated by using the handle on the rear lid.





Fig. 54 Rear lid: opening from the outside

Opening the rear lid

- Pull on the release lever and lift the rear lid ⇒ Fig. 54. The rear lid will automatically open.

Closing the rear lid

- Hold the rear lid by one of the two handles on the interior lining and close it, pushing slightly.

To lock/unlock, press the button  or the button  on the remote control key.

A warning appears on the instrument panel display if the rear lid is open or not properly closed.* An audible warning is also given if the rear lid is opened while the vehicle is moving faster than 6 km/h (4 mph).*



WARNING

- Always close the rear lid properly. Risk of accident or injury.
- The rear lid must not be opened when the reverse or rear fog lights are lit. This may damage the tail lights
- Do not close the rear lid by pushing it down with your hand on the rear window. The glass could smash. Risk of injury!
- Ensure the rear lid is locked after closing it. If not, it may open unexpectedly while driving.
- Never allow children to play in or around the vehicle. A locked vehicle can be subjected to extremely high and low temperatures, depending on the time of year, thus causing serious injuries/illness. It could even have fatal consequences. Close and lock both the rear lid and all the other doors when you are not using the vehicle.
- Closing the rear lid without observing and ensuring it is clear could cause serious injury to you and to third parties. Make sure that no one is in the path of the rear lid.

⚠ WARNING (Continued)

- Never drive with the rear lid open or half-closed, exhaust gases may penetrate into the interior of the vehicle. Danger of poisoning!
- If you only open the rear lid, do not leave the key inside. The vehicle will not be opened if the key is left inside.

Automatic rear lid locking

Where the vehicle has been locked by pressing the  button on the remote control with the rear lid open, the rear lid will lock automatically when closed.

The automatic rear lid locking time extension function can be activated. Where this function is activated and once the rear lid has been unlocked by pressing the  button on the remote control key ⇒ page 91, the rear lid can be re-opened for a certain length of time.

Where required, the automatic rear lid locking time extension function can be activated or deactivated at a SEAT Authorised Service, which will provide all of the necessary information.

Before the vehicle locks automatically, there is a risk of intruders getting in to the vehicle. Therefore, we recommend you always lock the vehicle by pressing the  button on the remote control or by using the central locking button.

Manual release of the rear lid in an emergency

The rear lid can be unlocked manually from inside in the event of an emergency.

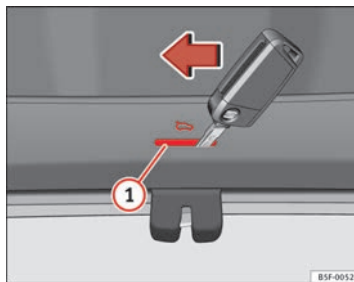



Fig. 55 Luggage compartment: access to manual release

- Insert the key in the opening in the lining of the rear lid  and move the key in the direction of the arrow until the lock is released.

Electric windows

Electronic control of windows*

The front and rear electric windows can be operated by using the controls on the driver door. The other doors each have a switch for their own window.

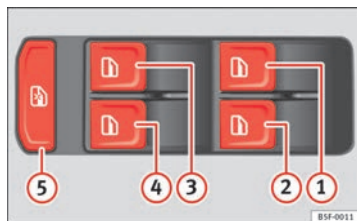

Fig. 56 Detail of the driver door: controls for the front and rear windows

Opening and closing the windows

- Press the button to open the window.
- Pull button to close the window ⇒ .

Always close the windows fully if you park the vehicle or leave it unattended ⇒ .

You can use the electric windows for approx. 10 minutes after switching off the ignition if neither the driver door nor the front passenger door has been opened and the key has not been removed from the ignition.

Buttons on the driver door

- ① Button for window in front left door
- ② Button for window in front right door

- ③ Button for window in rear left door
- ④ Button for window in rear right door
- ⑤ Safety switch for deactivating the electric window buttons in the rear doors

Safety switch *

Safety switch on the driver door can be used to disable the electric window buttons in the rear doors.

Safety switch not pressed: buttons on rear doors are activated.

Safety switch pressed: buttons on rear doors are deactivated.

The safety control symbol lights up in yellow if the buttons on the rear door are switched off.

WARNING

- Incorrect use of the electric windows can result in injury.
- Never close the rear lid without observing and ensuring it is clear, to do otherwise could cause serious injury to you and third parties. Make sure that no one is in the path of a window.
- Always take the vehicle key with you when you leave the vehicle.
- Never leave children or disabled persons in the vehicle, particularly if they have access to the keys. The misuse of the keys, for example, by children, may result in serious injury and accident.
- The engine may accidentally be started and be out of control.
- If the ignition is switched on, the electric equipment could be activated with risk of injury, for example, in the electric windows.
- The doors can be locked using the remote control key. This could become an obstacle for assistance in an emergency situation.
- Always take the key with you when you leave the vehicle.

⚠ WARNING (Continued)

- The electric windows will work until the ignition has been switched off and one of the front doors has been opened.
- If necessary, use the safety switch to disable the rear electric windows. Make sure that they have been disabled.



i Note

If the window is not able to close because it is stiff or because of an obstruction, the window will automatically open again ⇒ page 102. If this happens, check why the window could not be closed before attempting to close it again.



Convenience opening/closing

Use the convenience opening/closing function to easily open/close all the windows and the sliding/tilting sunroof* from the outside.

Convenience open function

- Press and hold button  on the remote control key until all the windows and the sliding/tilting sunroof* have reached the desired position, or
- First unlock the vehicle using button  on the remote control key and then keep the key in the driver door lock until all the windows and the sliding/tilting sunroof* have reached the required position.

Convenience close function

- Press and hold button  on the remote control key until all the windows and the sliding/tilting sunroof* are closed ⇒ , or

- Keep the key in the driver door in the "lock" position until all the windows and the sliding/tilting sunroof* are closed.

Programming convenience opening in the Easy Connect*





- Select: function button  > control button **Vehicle systems*** > **Vehicle settings** > **Central locking** > **Open the window by holding button down** or > **Front window on/off** or **Sunroof on/off***

⚠ WARNING

- Take care when closing the sliding/tilting sunroof* and windows. There is a risk of suffering injury.
- For safety reasons, you should only use the remote control open and close functions within about 2 metres of the vehicle. To avoid injuries, always keep an eye on the windows and the sliding/tilting sunroof* when pressing the button to close them. The windows stop moving as soon as the button is released.

One-touch opening and closing*

One-touch opening and closing means you do not have to hold down the button.

Buttons ⇒ Fig. 56 , ,  and  have two positions for opening windows and two for closing them. This makes it easier to open and close windows to the desired position.

One-touch closing

- Pull up the window button briefly up to the second position. The window closes fully. ▶

One-touch opening

- Push down the window button briefly up to the second position. The window opens fully.

Restoring one-touch opening and closing

- The automatic open and close function will not work if the battery has been temporarily disconnected. The function can be restored as follows:
- Close the window as far as it will go by lifting and holding the electric window switch.
- Release the switch and then lift it again for one second. This will re-enable the automatic function.

If you push (or pull) a button to the first stage, the window will open (or close) until you release the button. If you push or lift the button briefly to the second stage, the window will open (one-touch opening) or close (one-touch closing) automatically. If you operate the button while the window is opening or closing, it stops at this position. ■

Roll-back function

The roll-back function reduces the risk of injury when the electric windows close.

- If a window is obstructed when closing automatically, the window stops at this point and lowers immediately ⇒ .
- Next, check why the window does not close before attempting it again.
- If you try within the following 10 seconds and the window closes again with difficulty or there is an obstruction, the automatic closing will stop working for 10 seconds.

- If the window is still obstructed, the window will stop at this point.
- If there is no obvious reason why the window cannot be closed, try to close it again by pulling the tab within ten seconds. The window closes with maximum force. **The roll-back function is now deactivated.**

If more than 10 seconds pass, the window will open fully when you operate one of the buttons. One-touch closing is reactivated.

WARNING

- **Incorrect use of the electric windows can result in injury.**
- **Always take the ignition key with you when leaving the vehicle, even if you only intend to be gone for a short time. Please ensure that children are never left alone inside the vehicle.**
- **The electric windows will work until the ignition has been switched off and one of the front doors has been opened.**
- **Closing the windows without observing and ensuring it is clear could cause serious injury to you and third parties. Make sure that no one is in the path of a window.**
- **Never allow people to remain in the vehicle when you close the vehicle from the outside. The windows cannot be opened even in an emergency.**
- **The roll-back function does not prevent fingers or other parts of the body getting pinched against the window frame. Risk of accident.** ■

Panoramic sliding sunroof*

Introduction

Additional information and warnings:

- SEAT information system → page 73
- Central locking and locking system → page 86

WARNING

Careless or uncontrolled use of the panoramic sliding sunroof can cause serious injuries.

- Only open or close the panoramic sliding sunroof when nobody is in the way of its travel.
- Always take all the keys with you whenever you leave the vehicle.
- Never leave children or disabled persons in the vehicle, particularly if they have access to the keys. Uncontrolled use of the key could lock the vehicle, start the engine, turn on the ignition and operate the panoramic sliding sunroof.
- The panoramic sliding sunroof can be operated for up to about ten minutes after the ignition has been switched off, provided the driver door and the front passenger door are not opened.

Note

In case of a fault in the operation of the panoramic sliding sunroof, the anti-trap function will not operate correctly. Visit a specialised workshop. ■

Opening or closing the panoramic sliding sunroof

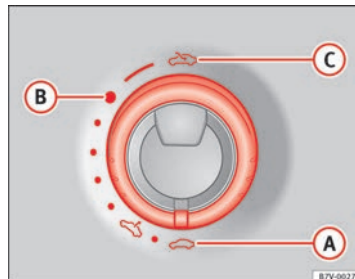

Fig. 57 On the interior roof lining: use the rotary button for opening and closing

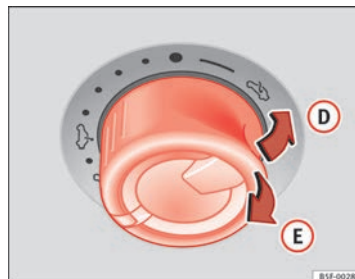

Fig. 58 On the interior roof lining: Press the button and pull on it to lift and close the sliding sunroof

To open the panoramic sliding sunroof, the switch must be in the position



Function	Switch setting	Necessary operations
⇒ Fig. 57		
To open the sliding sunroof completely:	C	Rotate the switch to the required position.
To choose the convenience position for the sliding sunroof:	B	
To close the sliding sunroof completely:	A	
⇒ Fig. 58		
To completely deploy the tilting sunroof:	D	Briefly push the switch up (arrow).
To stop automatic operation:	D or E	Briefly push back the button again or pull it.
To completely close the tilting sunroof:	E	Briefly push the switch up (arrow).
To set the intermediate position:	D or E	Push the button up or hold it back until the roof is in the required position.

The panoramic sliding sunroof will only work with the ignition on. The panoramic sliding sunroof can be operated for up to about ten minutes after the ignition has been switched off, provided the driver door and the front passenger door are not opened.

CAUTION

Check that when the rear lid is open, it does not touch loads carried on the roof. When a roof carrier is fitted, **DO NOT** open the panoramic roof*.

Panoramic sliding sunroof: operation

Convenience open/close function

The panoramic sliding sunroof can be opened or closed from outside the vehicle using the vehicle key:

- Keep the vehicle unlocking or locking button pressed. The panoramic sliding sunroof is adjusted or closes.
- Release the unlock or lock button to stop the function.

During convenience closing, first the windows and then the panoramic sliding sunroof will be closed.

Note

The panoramic sliding sunroof rotary button remains in the last position selected if the roof is closed using convenience closing from outside the vehicle and will have to be re-positioned the next time you drive.

Roll-back function on panoramic sliding sunroof

The roll-back function can reduce the risk of injury when opening and closing the panoramic sliding sunroof ⇒ . When the panoramic sliding sunroof encounters an obstacle while closing, it rolls back and opens again.

- Check why the panoramic sliding sunroof does not close.
- Try to close the panoramic sliding sunroof again.
- If the panoramic sliding sunroof is still obstructed, it will stop at the corresponding position. Next, close the panoramic sliding sunroof without the roll-back function.

Closing without the roll-back function

- The ⇒ Fig. 57 ① switch should be in the “closed” position ①.
- Within five seconds of triggering the roll-back function, pull the control all the way back ⇒ Fig. 58 (arrow ②) until the panoramic sliding sunroof closes fully.
- **The panoramic sliding sunroof closes without the roll-back function.**
- If the panoramic sliding sunroof still cannot be closed, visit a specialised workshop.



WARNING

Closing the panoramic sliding sunroof without the roll-back function may result in serious injury.

- Always close the panoramic sliding sunroof carefully.
- Make sure that nobody is in the way of the panoramic sliding sunroof, especially when it is closed without the roll-back function.
- The anti-trap function does not prevent fingers or other parts of the body getting pinched against the window frame and causing injury.



Note

The anti-trap function is activated if the windows and the panoramic sliding sunroof are closed from the outside of the vehicle using the ignition key for convenience closing ⇒ page 101. ■

Lights and visibility

Lights

Introduction

The legal requirements regarding the use of vehicle lights in each country must be observed.

The driver is personally responsible for the correct use and adjustment of the lights in all situations.

Additional information and warnings:







- Information system ⇒ page 73
- Changing bulbs ⇒ page 252

WARNING

If the headlights are regulated too high and the main beam is not used correctly, there is a risk of dazzling or distracting other road users. This could result in a serious accident.

- Always make sure that the headlights are correctly adjusted.
- Never use the main beam or headlight flasher when it can dazzle other drivers.

Control lamps

lights up	Possible cause	Solution
	Driving light totally or partially faulty.	Replace the corresponding bulb ⇒ page 252. If all the bulbs are OK, the vehicle should be taken to a specialised workshop if necessary.
	Rear fog light switched on.	⇒ page 108.
	Fog lights switched on	
	Left or right turn signal. The control lamp flashes twice as fast when a vehicle or trailer turn signal is faulty.	If necessary, check the vehicle and trailer lighting.
	Main beam on or flasher on.	⇒ page 107.
	Light Assist on.	⇒ page 109.

Several warning and control lamps should light up for a few seconds when the ignition is switched on, signalling that the function is being verified. They will switch off after a few seconds.

! WARNING

If the warning lamps and messages are ignored, the vehicle may stall in traffic, or may cause accidents and severe injuries.

- Never ignore the warning lamps or text messages.
- Stop the vehicle safely as soon as possible.
- Park the vehicle at a suitable distance away from the traffic ensuring that the exhaust system is not in contact with inflammable material, for example, dry grass, fuel, oil, etc.
- A faulty vehicle represents a risk of accident for the driver and for other road users. If necessary, switch on the hazard warning lamps and put out the warning triangle to advise other drivers.

! CAUTION

Failure to heed the control lamps and text messages when they appear may result in faults in the vehicle. ■

Turn signal and main beam lever*

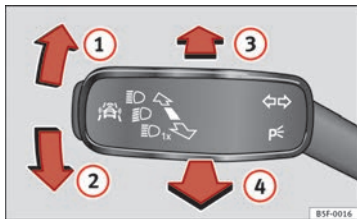

Fig. 59 Turn signal and main beam lever

Move the lever to the required position:

- ① Right turn signal. Right-hand parking light (ignition switched off) ⇒ page 109.
- ② Left turn signal. Left-hand parking light (ignition switched off) ⇒ page 109.
- ③ Main beam switched on ⇒ . The control lamp will light up on the instrument panel.
- ④ Flashing the headlights. The *flashed beam* comes on if the lever is pressed. The control lamp will light up.

Push the lever all the way down to turn off the corresponding function.

Convenience turn signals

For the convenience turn signals, move the lever as far as possible upwards or downwards and release the lever. The turn signal will flash three times.

The convenience turn signals are activated and deactivated in the Easy Connect system via the key and the function button ⇒ page 79.

In vehicles that do not have the corresponding menu, this function can be deactivated in a specialised workshop.

! WARNING

Improper or lack of use of the turn signals, or forgetting to deactivate them can confuse other road users. This could result in a serious accident.

- Always give warning when you are going to change lane, overtake or when turning, activating the turn signal in good time.
- As soon as you have finished changing lane, overtaking or turning, switch the turn signal off.

! WARNING

Incorrect use of the headlights may cause accidents and serious injury, as the main beam may distract or dazzle other drivers. ▶

**Note**

- The turn signal only works when the ignition is switched on. The hazard warning lights also work when the ignition is switched off.
- If a trailer turn signal malfunctions, the control lamp will stop flashing (trailer turn signals) and the vehicle turn signal will flash at double speed.
- The *main beam headlights* can only be switched on if the dipped beam headlights are already on.

Turning lights on and off

**Fig. 60 Dash panel:
Light switch**

The legal requirements regarding the use of vehicle lights in each country must be observed.

Turn the light switch to the required position ⇒ Fig. 60:

Symbol	if the ignition is switched off	when the ignition is on
0	Fog lights, dipped beam and side lights off.	Light off, or daytime driving light on.
AUTO	The "Coming home" and "Leaving home" guide lights may be switched on.	Automatic control of dipped beam and daytime driving light.

Symbol	if the ignition is switched off	when the ignition is on
	Side light on.	Side light on.
	Dipped beam off; if necessary, the side light comes on for a time.	Dipped beam switched on.

Fog lights

The control lamps and also show, on the light switch or instrument panel, when the fog lights are on.

- Switching on the fog lights : pull the light switch to the first stop, from positions , , or **AUTO**.
- Switching on the rear fog light : pull the light switch completely from position , , or **AUTO**.
- To switch off the fog lights, press the light switch or turn it to position **0**.

Audible warnings to advise the driver that the lights have not been switched off

If the key is not in the ignition and the driver door is open, an audible warning signal is heard in the following cases: This is a reminder to turn off the lights.

- When the parking light is on ⇒ page 107.
- When the light switch is in position or .

**WARNING**

The side lights or daytime driving lights are not bright enough to illuminate the road ahead and to ensure that other road users are able to see you.

- Always use your dipped beam head lights if it is raining or if visibility is poor.

Lights and visibility: functions

Parking light

When the parking light is switched on, (right or left turn signal), the front side light and the rear light on the corresponding side of the vehicle stay lit. The parking lights can only be activated with the ignition switched off and the turn signal and main beam lever in the central position, before being triggered.

Parking light on both sides

With the ignition switched off and the light switch in position \Rightarrow , when locking the vehicle from the outside, the parking lights on both sides of the vehicle light up. In doing so, only the side lights of both headlights light up, and additionally the tail lights will do so partially.

Daytime driving light*

The daytime driving lights consist of individual lights, integrated in the front headlights. With the daylight driving lights on, only these lights switch on \Rightarrow \triangle .

The daytime driving lights switch on every time the ignition is switched on, if the switch is in positions **0** or **AUTO**, according to the level of exterior lighting.

When the light switch is in position **AUTO**, a light sensor automatically switches dipped beam on and off (including the control and instrument lighting) or the daytime driving lights depending on the level of exterior lighting.

Automatic dipped beam control AUTO

The automatic dipped beam control is merely intended as an aid and is not able to recognise all driving situations.

When the light switch is in position **AUTO**, the vehicle lights and the instrument panel and switch lighting switch on and off automatically in the following situations \Rightarrow \triangle :

Automatic switching on:	Automatic switching off:
The photo sensor detects <i>darkness</i> , for example, when driving through a tunnel.	When adequate lighting is detected.
The rain sensor detects rain and activates the windscreen wipers.	When the windscreen wipers have been inactive for a few minutes.

Cornering lights*¹⁾

When turning slowly or on very tight bends, the cornering lights are activated automatically. The cornering lights may be integrated in the fog lights and are switched on only at speeds of less than 40 km/h (25 mph).

When reverse gear is engaged, the cornering lights on both sides of the vehicle switch on, in order to better illuminate the area for parking.

Motorway lights*

The motorway lights are available on vehicles equipped both with full-LED lights and headlights that switch on automatically.

- They are activated when the light switch is in position **AUTO**.
- They are deactivated when the light switch is not in position **AUTO**.

When going above 110 km/h (75 mph) for more than 30 seconds, the dipped beam raises slightly to increase the distance of visibility of the driver. When reducing the speed of the car below 100 km/h (60 mph), the dipped beam returns to its normal position. ▶

¹⁾ This function is not available on vehicles equipped with full-LED headlights.

⚠ WARNING

If the road is not well lit and other road users cannot see the vehicle well enough or at all, accidents may occur.

- The automatic dipped beam control (AUTO) only switches on the dipped beam when there are no changes in brightness, and not, for example when it is foggy.
- Never drive with daytime lights if the road is not well lit due to weather or lighting conditions. Daytime lights do not provide enough light to illuminate the road properly or be seen by other road users.
- The rear lights do not come on with the daytime driving light. A vehicle which does not have the rear lights on may not be visible to other drivers in the darkness, in the case of heavy rain or in conditions of poor visibility.



Note

In cold or damp weather conditions, the headlights, tail lights and turn signals may mist up inside temporarily. This is normal and in no way effects the useful life of the vehicle lighting system.

Hazard warning lights

The hazard warning lights are used to draw the attention of other road users to your vehicle in emergencies.



Fig. 61 Dash panel: switch for hazard warning lights

■ If your vehicle breaks down:

1. Park your vehicle at a safe distance from moving traffic.
2. Press the button to switch on the hazard warning lights ⇒ .
3. Switch the ignition off.
4. Apply the handbrake.
5. On a manual gearbox engage 1st gear. On an automatic gearbox, move the selector lever to **P**.
6. Use the warning triangle to draw the attention of other road users to your vehicle. ▶

7. Always take the vehicle key with you when you leave the vehicle.

Switch on the hazard warning lights to warn other road users, for example:

- reaching the tail end of a traffic jam,
- there is an emergency
- your vehicle breaks down due to a technical fault,
- you are towing another vehicle or your vehicle is being towed.

All turn signals flash simultaneously when the hazard warning lights are switched on. The two turn signal turn signal lamps \leftrightarrow and the turn signal lamp in the switch \triangle will flash at the same time. The hazard warning lights also work when the ignition is switched off.

Emergency braking warning

If the vehicle is braked suddenly and continuously at a speed of more than 80 km/h (50 mph), the brake light flashes several times per second to warn vehicles driving behind. If you continue braking, the hazard warning lights will come on automatically when the vehicle comes to a standstill. They switch off automatically when the vehicle starts to move again.



WARNING

- **The risk of an accident increases if your vehicle breaks down. Always use the hazard warning lights and a warning triangle to draw the attention of other road users to your stationary vehicle.**
- **Never park where the catalytic converter could come into contact with inflammable materials under the vehicle, for example dry grass or spilt petrol. This could start a fire!**



Note

- The battery will run down if the hazard warning lights are left on for a long time, even if the ignition is switched off.
- The use of the hazard warning lights described here is subject to the relevant statutory requirements.

Main beam assist*

Main beam assist (Light Assist)

The main beam assist operates, within the limits of the system and depending on the environmental and traffic conditions, as of a speed of 60 km/h (40 mph) when it switches on automatically, and is then deactivated again below 30 km/h (20 mph) \Rightarrow \triangle . This is managed via a camera situated on the base of the interior rear vision mirror.

The main beam assist generally detects illuminated areas and deactivates the main beam when passing through a town, for example.

Switching the main beam assist on and off

Function	Action
Activate:	<ul style="list-style-type: none"> – Switch the ignition on and turn the light switch to position AUTO. – From the base position, move the main beam and turn signal lever forwards ⇒ page 107. When the warning lamp  is displayed on the instrument panel display, the main beam assist is switched on.
Deactivate:	<ul style="list-style-type: none"> – Switch off the ignition. – OR: Turn the light switch to a different position to AUTO ⇒ page 108. – OR: with main beam on, move the main beam and turn signal lever backwards. – OR: Move the main beam and turn signal lever forwards to manually switch main beam on. The main beam assist will then be deactivated.

Malfunctions

The following conditions may prevent the main beam headlight control from turning off the headlights in time or from turning off altogether:

- In poorly lit towns with highly reflective signs.
- Other insufficiently lit road users (such as pedestrians or cyclists).
- On tight bends and steep slopes (bumps) and when oncoming vehicles are partially obscured.
- When the drivers of other oncoming vehicles (such as a truck) can see over a guard rail in the centre of the road.
- If the camera is damaged or the power supply is cut off.
- In fog, snow and heavy rain.
- With dust and sand turbulence.
- With loose gravel in the field of vision of the camera.
- When the field of vision of the camera is misted up, dirty or covered by stickers, snow, ice...



WARNING

The convenience features of the main beam assist should not encourage the taking of risks. The system is not a replacement for driver concentration.

- You are always in control of the main beam and adapting it to the light, visibility and traffic conditions.
- It is possible that the main beam headlight control does not recognise all driving situations and is limited under certain circumstances.
- When the field of vision of the camera is dirty, covered or damaged, operation of the main beam control may be affected. This also applies when changes are made to the vehicle lighting system, for example, if additional headlights are installed.



CAUTION

To avoid affecting the operation of the system, take the following points into consideration:

- Clean the field of vision of the camera regularly and make sure it is free of snow and ice.
- Do not cover the field of vision of the camera.
- Check that the windscreen is not damaged in the area of the field of vision of the camera.



Note

Main beam and headlight flasher can be turned on and off manually at any time with the turn signal and main beam lever ⇒ page 107. ■

Adjusting the headlights

The light beam of the dipped beam lights is asymmetric: the side of the road on which you are driving is lit more intensely. ►

When a car that is manufactured in a country that drives on the right travels to a country that drives on the left (or vice versa), it is normally necessary to cover part of the headlight bulbs with stickers or to change the adjustment of the headlights to avoid dazzling other drivers.

In such cases, the regulations specify certain light values that must be complied with for designated points of the light distribution. This is known as "Tourist light".

The light distribution that the halogen and full-LED headlights of the SEAT Leon range have, allows the specific "tourist light" values to be met without the need for stickers or changes in the settings.



Note

"Tourist light" is only allowed temporarily. If you are planning a long stay in a country that drives on the other side, you should take the vehicle to an Authorised Technical Service to change the headlights. ■

"Coming home" and "Leaving home" function (guidance lights)*

The "Coming home" function should be switched on manually. However the "Leaving home" function is automatically controlled by a photo sensor.

"Coming home"	Necessary operations
To switch system on:	<ul style="list-style-type: none"> – Switch off the ignition. – Briefly flash the headlights <i>for approximately one second</i> ⇒ page 107. <p>The "Coming home" lighting comes on when the driver door is opened. The <i>delay in switching off the headlights</i> is counted from when the last door or rear lid is closed.</p>
The system switches off:	<ul style="list-style-type: none"> – Automatically at the end of the delay period. – Automatically, if 30 seconds after coming on, a vehicle door or the rear lid remains open. – If the light switch is turned to position 0. – If the ignition is switched on.
"Leaving home"	Necessary operations
To switch system on:	<ul style="list-style-type: none"> – Unlock the vehicle when the light switch is in position AUTO and the photo sensor detects <i>darkness</i>.
The system switches off:	<ul style="list-style-type: none"> – Automatically, at the end of the delay period. – When the vehicle is locked. – When the light switch is turned to position 0. – When the ignition is switched on.



Note

- In the Easy Connect system, the duration of the lighting can be adjusted, and the function activated and deactivated ⇒ page 79 using the button **CAR** and the function button **Setup**.
- When the "Coming home" function is activated, a tone can be heard when the driver door is opened to warn that the light remains switched on. ■

Headlight range control, lighting of the instrument panel and controls



Fig. 62 Next to the steering wheel: Headlight range control

Lighting of the instrument panel and controls*

Depending on the model, lighting of the instrument panel and controls can be adjusted in the Easy Connect system, using the button **CAR** and the function button **SETUP** ⇒ page 81.

Headlight range control

The headlight range control ⇒ Fig. 62 is modified according to the value of the headlight beam and the vehicle load status. This offers the driver optimum visibility and the headlights do not dazzle oncoming drivers ⇒ ⚠.

The headlights can only be adjusted when the dipped beam is switched on.

To reset, turn switch ⇒ Fig. 62:

Value	Vehicle load status ^{a)}
–	Two front occupants, luggage compartment empty
1	All seats occupied, luggage compartment empty

Value	Vehicle load status ^{a)}
2	All seats occupied, luggage compartment full With trailer and minimum drawbar load
3	Driver only, luggage compartment full With trailer and maximum drawbar load

^{a)} If the vehicle load does not correspond to those shown in the table, it is possible to select intermediary positions.

Dynamic headlight range control

The control is not mounted in vehicles with dynamic headlight range control. The headlight range is automatically adjusted according to the vehicle load status when the headlights are switched on.

Instrument panel lighting

In vehicles with the daytime driving light, the instrument panel lighting switches on in dark conditions (for example, when passing through a tunnel). This reminds the driver to manually switch on the dipped beam, so that the vehicle rear lights also switch on ⇒ page 109.







WARNING

Heavy objects in the vehicle may mean that the headlights dazzle and distract other drivers. This could result in a serious accident.

- Adjust the light beam to the vehicle load status so that it does not blind other drivers.

Interior and reading lights¹⁾

Button/ Switch	Function
	Switches interior lights off.
	Switches interior lights on.
	Switches door contact control on (central position). The interior lights come on automatically when the vehicle is unlocked, a door is opened or the key is removed from the ignition. The lights go off a few seconds after all the doors are closed, the vehicle is locked or the ignition is switched on.
	Turning the reading light on and off

Glove compartment and luggage compartment lighting

When opening and closing the glove compartment on the front passenger side and the rear lid, the respective light will automatically switch on and off.

Footwell lighting*

The lights in the footwell area below the dash (driver and front passenger sides) will switch on when the doors are opened and will decrease in intensity while driving. The intensity of these lights can be adjusted using the radio menu (see **Easy Connect > Adjusting Lighting > Interior lighting** ⇒ page 81).

Ambient light*

The ambient light in the door panel changes colour (white or red) depending on the driving mode. The intensity of these lights can be adjusted using

the radio menu (see **Easy Connect > Adjusting Lights > Interior lighting** ⇒ page 81).



Note

The reading lights switch off when the vehicle is locked using a key or after several minutes if the key is removed from the ignition. This prevents the battery from discharging.

Sun blind

Introduction



WARNING

Folded sun blinds can reduce visibility.

- Always store sun blinds and visors in their housing when not in use.

¹⁾ Depending on the level of equipment fitted in the vehicle, LEDs can be used for the following interior lights: front courtesy light, rear courtesy light, footwell light and sun visor light.

Sun visors

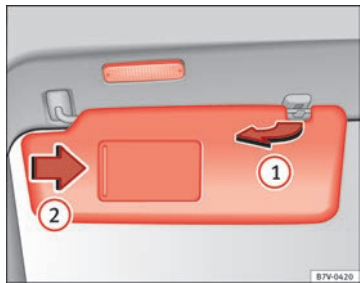

Fig. 63 Sun visor

Options for adjusting driver and front passenger sun visors:

- Lower by unfolding towards the windscreen.
- The sun visor can be pulled out of its mounting and turned towards the door → Fig. 63 ①.
- Swinging the sun visor towards the door, longitudinally backwards.

Vanity mirror light

There may be a vanity mirror, with a cover, on the rear of the sun visor. When the cover is opened ② a light comes on.

The lamp goes out when the vanity mirror cover is closed or the sun visor is pushed back up.



Note

The light above the sun visor automatically switches off after a few minutes in certain conditions. This prevents the battery from discharging. ■

Windscreen wiper system

Introduction

Additional information and warnings:

- Changing wheels round
- Heating, ventilation, cooling
- Caring for and cleaning the vehicle exterior



WARNING

If the water from the windscreen washer does not contain enough anti-freeze, it may freeze on the windscreen, reducing forward visibility.

- In winter, ensure the windscreen washer contains enough anti-freeze.
- In cold conditions, you should not use the wash/wipe system unless you have warmed the windscreen with the ventilation system. The anti-freeze could freeze on the windscreen and reduce visibility.



WARNING

Worn or dirty wiper blades reduce visibility and increase the risk of accident and serious injury.

- Always replace damaged or worn blades or blades which do not clean the windscreen correctly.



CAUTION

In icy conditions, always check that the wiper blades are not frozen to the glass before using the wipers. In cold weather, it may help to leave the vehicle parked with the wipers in service position → page 119. ■

Control lamp

lights up	Possible cause	Solution
	Windscreen wiper fluid level too low	Top up the windscreen wiper reservoir as soon as possible ⇒ page 121.

Several warning and control lamps should light up for a few seconds when the ignition is switched on, signalling that the function is being verified. They will switch off after a few seconds.

CAUTION

Failure to heed the control lamps and text messages when they appear may result in faults in the vehicle. ■

Window wiper lever

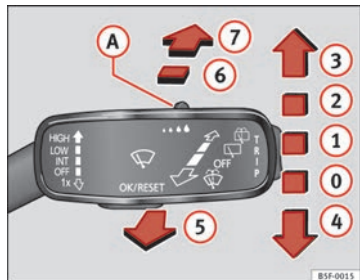





Fig. 64 Operating the windscreen wiper and rear wiper

Move the lever to the required position ⇒ ⓪:

⓪	OFF	Windscreen wiper off.
①	INT	Windscreen wipers interval wipe. Using the control ⇒ Fig. 64 A adjust the interval (vehicles without the rain sensor), or the sensitivity of the rain sensor.
②	LOW	Slow wipe.
③	HIGH	Continuous wipe.
④	1x	Brief press, short clean. Hold the lever down for more time to increase the wipe frequency.
⑤		The windscreen washer function is activated by pushing the lever forwards, and simultaneously the windscreen wipers start.
⑥		Interval wipe for rear window. The rear wiper will wipe the window approximately every six seconds.
⑦		The windscreen washer function is activated by pressing the lever, and the rear wiper starts simultaneously.

⚠ CAUTION

If the ignition is switched off with the windscreen wipers active, they complete their wipe before returning to the rest position. Ice, snow and other obstacles on the windscreen may damage the wiper and the windscreen wiper motor.

- If necessary, remove snow and ice from the windscreen wipers before starting your journey.
- Carefully lift the frozen windscreen wipers from the glass. SEAT recommends a de-icer spray for this operation.

⚠ CAUTION

Do not switch on the windscreen wipers if the windscreen is dry. Cleaning with the windscreen wipers while dry can cause damage.

ⓘ Note

- The windscreen wipers will only function when the ignition is switched on and the respective bonnet or rear lid are closed.
- The interval wipe speed varies according to the vehicle speed. The faster the vehicle is moving, the more often the windscreen is cleaned.
- The rear wiper is automatically switched on when the windscreen wiper is on and the car is in reverse gear. ■

Windscreen wiper functions

Windscreen wiper performance in different situations:

If the vehicle is at a standstill:	The activated position provisionally changes to the previous position.
During the automatic wipe:	The air conditioner comes on for approximately 30 seconds in air recirculation mode to prevent the smell of the windscreen washer fluid entering the inside the vehicle.
For the interval wipe:	The intervals between wipes vary according to the speed of the vehicle. The higher the vehicle speed the shorter the intervals.

Heated windscreen washer jets

The heating only thaws the frozen jets, it does not thaw the water in the washer hoses. The heated windscreen washer jets automatically adjust the heat depending on the ambient temperature, when the ignition is switched on.

Headlight wash/wipe system

The headlight washers/wipers clean the headlight lenses.

After the ignition is switched on, the first and every fifth time the windscreen washer is switched on, the headlights are also washed. Therefore, the windscreen wiper lever should be pulled towards the steering wheel when the dipped beam or main beam are on. Any incrusted dirt (such as insects) should be cleaned regularly (e.g. when refuelling).

To ensure the headlight washers work correctly in winter, any snow which has got into the bumper jet supports should be cleaned away. If necessary, remove snow with an anti-icing spray.



Note

The wiper will try to wipe away any obstacles that are on the windscreen. The wiper will stop moving if the obstacle blocks its path. Remove the obstacle and switch the wiper back on again.

Windscreen wipers service position

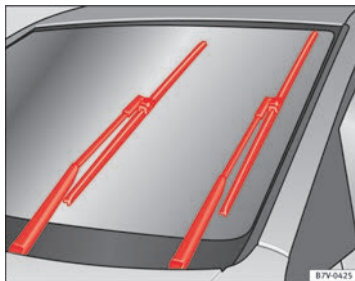

Fig. 65 Wipers in service position

The wiper arms can be raised when the wipers are in service position ⇒ Fig. 65. To place the windscreen wipers in the service position, proceed as follows:

- The bonnet must be closed ⇒ page 209.
- Switch the ignition on and off.
- Press the windscreen wiper lever downwards briefly ⇒ Fig. 64 ④.

Before driving, always lower the wiper arms. Using the windscreen wiper lever, the windscreen wiper arms return to their initial position.

Lifting and returning windscreen wiper arms

- Place the wiper arms in the service position ⇒ ①.
- Only hold the wiper arms at the point where the blade is fixed.

! CAUTION

- To prevent damage to the bonnet and the wiper arms, only leave them in the service position.
- Before driving, always lower the wiper arms.

Rain sensor*



Fig. 66 Windscreen wiper lever: adjusting the rain sensor (A)

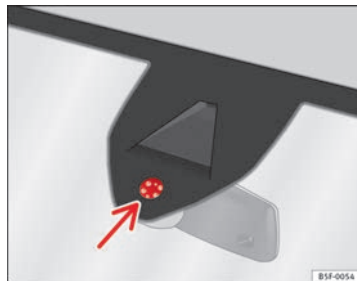

Fig. 67 Rain sensor sensitive surface

The rain sensor controls the frequency of the windscreen wiper intervals, depending on the amount of rain ⇒ Δ. The sensitivity of the rain sensor can be adjusted manually. Manual wipe ⇒ page 118

Move the lever to the required position ⇒ Fig. 66:

- ① Rain sensor off.
- ① Rain sensor on; automatic wipe if necessary.
- Ⓐ Setting sensitivity level of rain sensor
 - Set control to the right: highly sensitive.
 - Set control to the left: less sensitive.

When the ignition is switched off and then back on, the rain sensor stays on and starts operating again when the windscreen wipers are in position ① and the vehicle is travelling at more than 16 km/h (10 mph).

Rain sensor modified behaviour

Possible causes of faults and mistaken readings *on the sensitive surface* ⇒ Fig. 67 of the rain sensor include: ▶

- **Damaged blades:** A film of water on the damaged blades may lengthen the activation time, reduce the washing intervals or result in a fast and continuous wipe.
- **Insects:** insects on the sensor may trigger the windscreen washer.
- **Salt on roads:** in winter, salt spread in the roads may cause an extra long wipe when the windscreen is almost dry.
- **Dirt:** dry dust, wax, coating on glass (Lotus effect) or traces of detergent (car wash) may reduce the effectiveness of the rain sensor or make it react more slowly, later or not at all.
- **Cracked windscreen:** the impact of a stone will trigger a single wipe cycle with the rain sensor on. Next the rain sensor detects the reduction in the sensitive surface area and adapts accordingly. The behaviour of the sensor will vary with the size of the damage caused by the stone.

**WARNING**

The rain sensor may not detect enough rain to switch on the wipers.

- **If necessary, switch on the wipers manually when water on the windscreen obstructs visibility.**

**Note**

- Clean the sensitive surface of the rain sensor regularly and check the blades for damage ⇒ Fig. 67 (arrow).
- To remove wax and coatings, we recommend a window cleaner containing alcohol. ■

Checking and topping up the windscreen washer reservoir with water



Fig. 68 In the engine compartment: windscreen washer reservoir top

Check the water level in the windscreen washer reservoir regularly and top up as required.

- Open the bonnet ▲ ⇒ page 209.
- The washer reservoir is marked with the symbol ☁ on the lid ⇒ Fig. 68.
- Check there is enough water in the reservoir.
- To top up, mix water with a window cleaner recommended by SEAT ⇒ ④. Please follow the instructions for use found on the packaging.
- In cold weather, a special antifreeze should also be added to prevent the water from freezing ⇒ ▲.

Recommended windscreen wipers

- For the hottest seasons we recommend summer G 052 184 A1 for clear glass. Proportions of the mixture in the washer fluid tank: 1:100 (1 part concentrate per 100 parts water).
- All year round, G 052 164 A2 for clear glass. Approximate proportion of the winter mixture, up to -18 °C (0 °F): 1:2 (1 part concentrate per 2 parts water); otherwise, a 1:4 proportion of mixture in the washer fluid tank.

Reservoir capacity

The reservoir holds approximately 3 - 4 litres; in vehicles with headlight washer, it is approximately 3 -6 litres.



WARNING

Never mix an unsuitable antifreeze or other similar additives with the windscreen washer water. A greasy layer may be formed on the windscreen which will impair visibility.

- Use clean water with a window cleaner recommended by SEAT.
- If necessary, add a suitable antifreeze to the water in the reservoir.



CAUTION

- Do not mix cleaning products recommended by SEAT with other products. This could lead to flocculation and may block the windscreen washer jets.
- When topping up service fluids, make absolutely certain that you fill the fluids into the correct reservoirs. Using the wrong fluids could cause serious malfunctions and engine damage!

Rear vision mirror

Adjusting the exterior mirrors

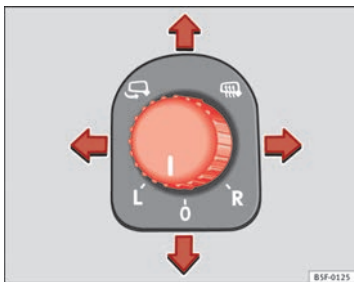



Fig. 69 Driver door: control for the exterior mirror

Turn the knob to the appropriate position:

L/R – In these positions you can adjust the exterior mirrors (left or right) by moving the control in the desired direction.

 – The surfaces of the exterior mirrors are heated* depending on the outside temperature, and on the equipment fitted in the vehicle.

 – The exterior mirrors are retracted*.

Synchronized regulation of the exterior mirrors

- In the **Settings - Convenience** menu, select whether or not the exterior mirrors should move in synchronisation ⇒ page 77.
- Turn the knob to position L.
- Adjust the left-hand exterior mirror. The right exterior mirror will be adjusted at the same time (synchronised).

- If necessary the right exterior mirror adjustment may need correcting. Turn the knob to position **R**.
- In the Easy Connect system the exterior mirrors can be adjusted using the **(CAR)** button and the function button **(SETUP)**.

Tilt function for front passenger exterior mirror*

The mirror can automatically tilt slightly to provide a better view of the kerb when parking backwards. The control must be in the position **R** for this feature to be operational.

The mirror returns to its original position as soon as you drive forwards at over 15 km/h (10 mph) or switch off the ignition. It also returns to its original position if the position of the control is adjusted.

WARNING

Convex or wide-angle* exterior mirrors give a larger field of vision. However, they make objects look smaller and further away than they really are. If you use these mirrors to estimate the distance to vehicles behind you when changing lane, you could misjudge the distance. Risk of accident!

CAUTION

- If one of the mirror housings is knocked out of position (e.g. when parking), the mirrors must first be fully retracted with the electric control. Do not readjust the mirror housing by hand, as this will interfere with the mirror adjuster function.
- Before washing the vehicle in an automatic car wash, please make sure to retract the exterior mirrors to prevent them from being damaged. Electrically retractable exterior mirrors must NOT be folded in or out by hand. Always use the electrical power control.

Note

If the electrical adjustment should fail to operate, both of the mirrors can be adjusted by hand by lightly pressing the edge of the mirror glass. ■

Anti-dazzle rear vision mirrors

Your vehicle is fitted with an interior rear vision mirror with a manual or automatic control for anti-dazzle position.

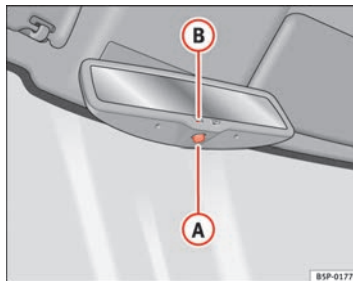

Fig. 70 Interior rear vision mirror with automatic setting for anti-dazzle position

Interior rear vision mirror with manual setting for anti-dazzle position

- Position the small lever of the lower edge of the mirror to face towards the rear.

Anti-dazzle rear vision mirror with automatic setting*

- Press the button **(A)**. Warning lamp **(B)** will light up. Depending on the amount of light incidence, the interior rear vision mirror and the exterior* mirrors darken (e.g. headlight shining from behind). ▶

**WARNING**

In the event that an automatic anti-dazzle rear vision mirror breaks, an electrolyte fluid may leak. This could cause irritation to the skin, eyes and respiratory organs. If you come into contact with this liquid, it must be rinsed with large quantities of water. If necessary, get medical help.

**CAUTION**

In the event that an automatic anti-dazzle rear vision mirror breaks, an electrolyte fluid may leak. This liquid attacks plastic surfaces. Clean the liquid with a wet sponge as soon as possible.

**Note**

- If the light incident in the interior rear vision mirror is obstructed (e.g. with the sun blind*), the anti-dazzle rear vision mirror with automatic setting will not operate perfectly.
- When the interior lights are on or reverse gear engaged, the rear vision mirrors do not darken with automatic adjustment for anti-dazzle position. ■

Seats and storage

General notes



WARNING

The Safe driving chapter contains important information, tips, suggestions and warnings that you should read and observe for your own safety and the safety of your passengers → page 7.

Front seats

Manual seat adjustment

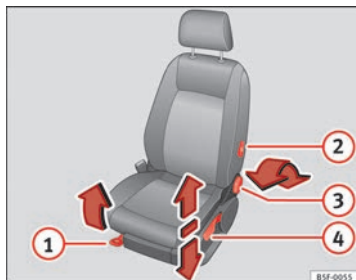

Fig. 71 Front seats:
manual seat adjustment

- ① Adjusting the seat forward/backward: pull the lever and move the seat forwards or backwards.
- ② Adjusting the lumbar support*: press the button in the corresponding position.
- ③ Backrest lower/raise: turn the hand wheel.
- ④ Raise/lower the seat: Pull/push the lever.



WARNING

- Adjust the front seats only when the vehicle is stationary. Failure to do so could result in an accident.
- Be careful when adjusting the seat height. Careless or uncontrolled adjustment can cause injuries.
- The front seat backrests must not be reclined for driving. Otherwise, seat belts and the airbag system might not protect as they should, with the subsequent danger of injury.

Front centre armrest

The centre armrest can be adjusted to various levels.

Adjusting the centre armrest

- To adjust the tilt, lift the armrest from the starting position so that it is engaged.
- To return the armrest to the starting position, remove the armrest from the upper fixed position and lower it.

The armrest can be moved backwards and forwards.

Seat functions

Introduction

Additional information and warnings

- Adjusting the position of the seats → page 10
- Seat belts → page 19
- Airbag system → page 30
- Child seats (accessories) → page 47

WARNING

Inappropriate use of the seat functions can cause severe injuries.

- Assume the proper sitting position before your trip and remain in it throughout. This also applies to the other occupants.
- Always keep hands, fingers, feet and other parts of the body away from the operating radius and the adjustment of seats.

Seat heating

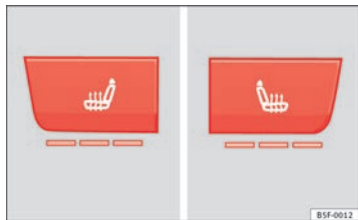







Fig. 72 In the centre console: front seats heating switch

The seat cushions can be heated electrically when the ignition is switched on. The backrest is also heated in some versions.

The seat heating should not be engaged in any of the following conditions:

- The seat is unoccupied.
- The seat has a covering.
- There is a child seat installed in the seat.
- The seat cushion is wet or damp.
- The indoor or outdoor temperature is greater than 25 °C (77 °F).

Function	Using seat heating
To switch system on:	Press the button  or  . Seat heating is switched on fully.
Adjusting the heating output:	Press the button  or  repeatedly until the desired intensity level is reached.
To switch system off:	Press the button  or  until all warning lamps switch off.

WARNING

People who, because of medications, paralysis or chronic diseases (e.g. diabetes) cannot perceive pain or temperature, or have a limited perception thereof, may suffer burns to the back, buttocks or legs when using seat heating, an occurrence that may entail a very lengthy recovery period or from which it may not be possible to recover fully. Seek medical advice if you have doubts regarding your health.

- People with a limit pain and temperature threshold must never use seat heating.

WARNING

If the fabric of the cushion is wet, this can adversely affect the operation of the seat heating, increasing the risk of burns.

- Make sure the seat cushion is dry prior to using the seat heater.
- Do not sit on the seat with clothing that is wet or damp.
- Do not leave clothing that is wet or damp on the seat.
- Do not spill liquid on the seat.

CAUTION

- To avoid damaging the heating elements of the seat heating, please do not kneel on the seat or apply sharp pressure at a single point to the seat cushion and backrest.
- Liquids, sharp objects and insulating materials (e.g., covers or child seats) can damage the seat heating.
- In the event of odours, switch off the seat heating immediately and have the unit inspected by a specialised workshop.



For the sake of the environment

The seat heating should remain on only when needed. Otherwise, it is an unnecessary fuel waste.

Head restraints

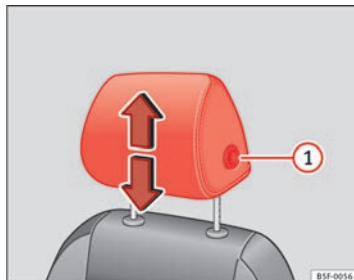

Fig. 73 Front seat: adjustment of the head restraint

Adjust the head restraint so that the top of the head restraint is level with the top of your head. When this is not possible, try to get as close as possible to this position.

- Grasp the sides of the head restraint with both hands and move it up/down (to lower you must press button **1**) until you see it engage.

Rear head restraints

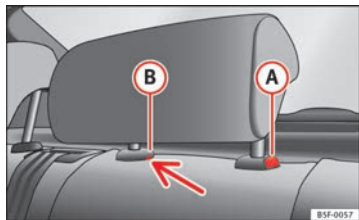

Fig. 74 Rear centre head restraint: release point

When transporting people in the back seat, place the head restraints of the occupied seats at a minimum of the next socket up ⇒ ⚠.

Adjusting the head restraints

- To set the head restraint higher, grasp the sides with both hands and move it upwards, until you see it engage.
- To set the head restraint lower down, press the **(A)** ⇒ Fig. 74 button and move it downwards.

Removing the head restraint

To remove the head restraint, the corresponding backrest must be partially folded forward.

- Unlock the backrest ⇒ page 132.
- Move the head restraint upwards until it arrives to the top.
- Press the **(A)** ⇒ Fig. 74 button while at the same time removing the head restraint from the backrest ⇒ ⚠.

- Insert a screwdriver in the **(B)** position of the hole while at the same time removing the head restraint from the backrest ⇒ ⚠.
- Move the backrest until it engages properly ⇒ ⚠ in Increase capacity of luggage compartment on page 133.

Fitting the head restraint

To mount the external head restraints, the corresponding backrest must be partially folded forward.

- Unlock the backrest ⇒ page 132.
- Insert the head restraint bars into the guides until they perceptibly engage. It should not be possible to remove the head restraint from the backrest.
- Move the backrest until it engages properly ⇒ ⚠ in Increase capacity of luggage compartment on page 133.

⚠ WARNING

- Please observe the general notes.
- Remove the rear head restraints only when it is necessary for the placement of a child seat ⇒ page 47. After removing a child seat, remount the head restraint immediately. Travelling with the head restraints removed or improperly adjusted increases the risk of severe injuries. ■

Power socket

Electrical equipment can be connected to the 12 volt power socket.

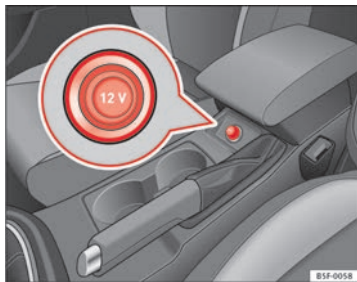

Fig. 75 Centre console: front/rear 12-volt power socket

- Remove the connector located in the centre console of the power socket ⇒ Fig. 75.
- Insert the plug of the electrical appliance into the power socket.

Electrical equipment can be connected to the 12 volt power socket. The appliances connected to each power socket must not exceed a power rating of 120 Watt.

WARNING

The power socket works only when the ignition is on. Improper use may cause serious injury or even fire. Children should therefore not be left in the vehicle, unattended, if the button is also left behind. Otherwise there is a possibility that they may be injured.

CAUTION

Always use the correct type of plugs to avoid damaging the sockets.

Note

The use of electrical appliances with the engine switched off will cause a battery discharge.

Storage

Drink holders



Fig. 76 Centre console: Front drink holders

Front drink holders

- Place drinks in the holder ⇒ Fig. 76. Placement of two drinks is possible. There is also the possibility of placing larger plastic bottles in the trims of the doors.

! WARNING

- Do not place any hot drinks in the drink holder while the vehicle is moving. Hot drinks could spill and cause burns, which may cause an accident.
- Do not use hard china cups or glasses. These could cause injury in the event of an accident.

! CAUTION

You should avoid putting open drinks containers in the cup holders. The drinks could otherwise spill over and cause damage to e.g. the electrical equipment or the seat covers.

Glove compartment

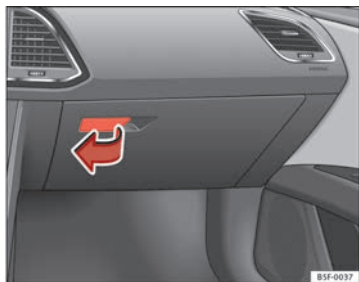

Fig. 77 Glove compartment

Open/close

- To open the glove compartment, pull the handle in the direction of the arrow.
- To close the glove compartment, move the cover upwards until it engages.

The CD-ROM reader* for the SEAT navigation system* is found in the glove compartment. Separate operating instructions are enclosed for this equipment in the corresponding Instruction Manual.

! WARNING

The cover of the glove compartment should always be closed while driving. Failure to do so could result in an accident.

Other storage compartments

You will find more object holders, compartments and supports in other parts of the vehicle:

- In the top of the glove compartment in vehicles that do not have a CD reader. The load must not exceed 1.2 kg.
- In the centre console under the centre armrest*.
- In the driver side panel there is a removable box for access to fuses and relays. The load of the compartment should not exceed 0.2 kg.
- Coat hooks in the pillar B ⇒ **!**
- Other storage compartments are found in the rear seat, to the left and the right of the seats. ▶

 **WARNING**

- Please make sure that any items of clothing hanging from the coat hooks do not obstruct your view to the rear.
- The coat hooks should only be used for lightweight clothing. Do not leave any heavy or sharp objects in the pockets.
- Do not use clothes hangers to hang up the clothing, as this could interfere with the function of the head-protection airbags.

Roof carrier

Note the following points if you intend to carry loads on the roof:

- In your car only certain roof carriers should be used. Roof carriers are the basis of a complete roof carrier system. To transport luggage and sports equipment, additional structures/transport systems are needed. We recommend roof carriers and structures from the SEAT accessories programme.
- When mounting the roof carrier, be sure to mount only on the points already provided on the roof. The front and rear attachment points are only visible when the doors are open.
- The maximum permissible roof load for your vehicle is 75 kg. The load limit applies to the combined weight of the roof carrier, the structures, and load itself. However, check the load permitted by the specific loading system being used. Permissible axle weight and permissible total weight for your vehicle ⇒ page 267.

 **WARNING**

- Take note of the mounting instructions for the roof carrier system. If the carrier system and the roof load are not properly secured, items of luggage could fall from the vehicle and cause an accident.
- When you use a roof carrier system the style of driving changes due to a shift of emphasis and the larger surface area exposed to wind drag, which could cause an accident. Therefore, it is essential to adjust your speed and driving style accordingly, to avoid accidents.

 **CAUTION**

Check that when the rear lid is open, it does not touch loads carried on the roof. When a roof carrier is fitted, **DO NOT** open the panoramic roof*.

For the sake of the environment

Greater aerodynamic drag increases fuel consumption. For this reason you should always take off the roof carrier when it is not in use.

Luggage compartment

General notes

 **WARNING**

The Safe driving chapter contains important information, tips, suggestions and warnings that you should read and observe for your own safety and the safety of your passengers ⇒ page 7.

Luggage compartment cover

The luggage compartment cover blocks the view into the luggage compartment.

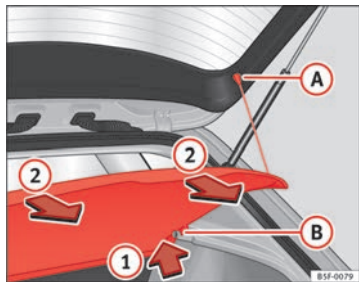

Fig. 78 Rear lid open with the luggage compartment cover

Removing

- Remove the straps (A) and unfasten the cover of the support (B) by pressing upwards in the direction of arrow (1).

Fitting

- Insert the cover horizontally so that it coincides with the “plate” on the axis of the supports (B) and press down until it engages.
- Attach the straps to the rear lid (A) ⇒ ⚠.

⚠ WARNING

- The luggage compartment cover must always be fixed properly (risk of accident).
- The luggage compartment cover should not be used as a storage shelf. Articles placed on this cover could cause injury to vehicle occupants in an accident or if the brakes are applied suddenly.

Increase capacity of luggage compartment

The backrests can be folded forward individually or together.

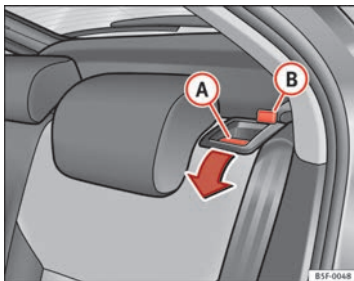

Fig. 79 Backrest release lever

Folding the backrest forwards

- Slide the head restraint(s) downwards ⇒ page 128.
- Press the release lever (A) in the direction indicated (arrow). ▶

- Fold the backrest forwards.

Returning the backrest to its upright position

- Move the backrest until it engages properly ⇒ ⚠. The red marking on the tab ⓑ should no longer be visible when the backrest is properly secured.

⚠ WARNING

- Make sure that the rear backrest is securely locked in position so that the seat belt can provide proper protection on the centre rear seat.
- The rear backrest must always be securely latched so that objects stored in the luggage compartment will not fly forward through the interior during sudden braking.



CAUTION

- With the backrest inclined there is a danger of damaging the rear head restraints when adjusting the front seats backwards.
- When returning the backrest to an upright position, make sure that the side seat belts are not caught up and damaged in the catches for the backrest.

Fastening rings*

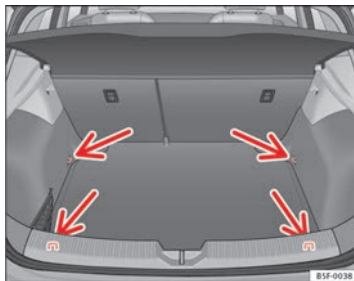

Fig. 80 Location of fastening rings in luggage compartment

- Secure the load using the fastening rings -arrows-.
- Please refer to the safety notes ⇒ page 17.

Air conditioning

Heating, ventilation, cooling

Introduction

Viewing Climatronic information

On the screen of Climatronic control unit and on the screen of the factory-fitted Easy Connect system, the theoretical values of the temperature zones are shown.

The unit of temperature measurement can be changed in the Easy Connect system.

Dust and pollen filter

The dust and pollen filter with its activated charcoal cartridge serves as a barrier against impurities in the air taken into the vehicle interior.

The dust and pollen filter must be changed regularly so that air conditioner performance is not adversely affected.

If the filter loses efficiency prematurely due to use in areas with very high levels of air pollution, the filter must be changed more frequently than stated in the Service Schedule.

Additional information and warnings:

- Easy Connect system
- Seat functions
- Windscreen wipers and washers
- Caring for and cleaning the vehicle exterior



WARNING

Reduced visibility through the windows increases the risk of serious accidents.

- Always ensure that all windows are free of ice and snow, and that they are not fogged, so as to maintain good visibility of everything outside.
- The maximum heat output required to defrost windows as quickly as possible is only available when the engine has reached its normal running temperature. Only drive when you have good visibility.
- Always ensure that you use the heating system, fresh air system, air conditioner and the heated rear window to maintain good visibility to the outside.
- Never leave the air recirculation on for a long period of time. If the cooling system is switched off and air recirculation mode switched on, the windows can mist over very quickly, considerably limiting visibility.
- Switch air recirculation mode off when it is not required.



WARNING

Stuffy or used air will increase fatigue and reduce driver concentration possibly resulting in a serious accident.

- Never leave the fresh air fan turned off or use the air recirculation for long periods of time; the air in the vehicle interior will not be refreshed. ▶

! CAUTION

- Switch the air conditioner off if you think it may be broken. This will avoid additional damage. Have the air conditioner checked by a specialised workshop.
- Repairs to the air conditioner require specialist knowledge and special tools. SEAT recommends visiting a SEAT Official Service.

i Note

- When the cooling system is turned off, air coming from the outside will not be dried. To prevent fogging of the windows, SEAT recommends leaving the cooling system (compressor) turned on. To do this, press the button . The button lamp should light up.
- The maximum heat output required to defrost windows as quickly as possible is only available when the engine has reached its normal running temperature.
- Keep the air intake slots in front of the windscreen free of snow, ice and leaves to ensure heating and cooling are not impaired, and to prevent the windows from misting over.



Air conditioner controls



Fig. 81 In the centre console: Climatronic controls

To switch a function on or off, press the appropriate button. Press the button again to switch off the function.

The LED on each control lights up to indicate that the respective function of a control has been switched on.

Control button	Additional information. Climatronic.
 <p>① Temperature</p>	The left and right sides can be adjusted separately. Rotate the control to adjust the temperature accordingly.
 <p>② Fan</p>	The power of the fan is automatically adjusted. The fan is also adjusted manually by turning the control.
 <p>③ Air distribution</p>	The airflow adjusts automatically for comfort. You can also switch it on manually using the buttons ③.

Control button	Additional information. Climatronic.
	Indications on the temperature display screen selected for the right and left sides.
MAX	Defrost function. The air drawn in from outside the vehicle is directed at the windscreen and air recirculation is automatically switched off. To defrost the windscreen more quickly, the air is dehumidified at temperatures over approximately +3 °C (+38 °F) and the fan runs at maximum output.
	The air is directed at the chest of driver and passengers by the dash panel air vents.
	Air distribution towards the footwell.
	Upward air distribution.
	Heated rear window: this only works when the engine is running and switches off automatically after a maximum of 10 minutes.
	Air recirculation ⇒ page 141.
	Buttons for seat heating ⇒ page 126.
A/C	Press the button to switch on or off the cooling system.
A/C MAX	Press the button to make maximum cooling capacity available. The recirculation of air and the cooling system turn on automatically and air distribution adjusts automatically to the position
SYNC	Transfer the driver side temperature settings to the passenger side: when the button lamp is lit (SYNC) , the temperature settings on the driver side also apply to the passenger side. Press the button or the temperature control on the passenger side in order to change the temperature on that side. The button lamp is lit.

Control button	Additional information. Climatronic.
AUTO	Automatic adjustment of temperature, fan, and air distribution. Press the button to switch on the function. The button will light up (AUTO) .
SETUP	When the configuration button (SETUP) is pressed the air conditioner management menu will be shown on the Easy Connect system screen.
Switching off	Turn the fan control to the 0 position or press the button (OFF) .

WARNING

Stuffy or used air will increase fatigue and reduce driver concentration possibly resulting in a serious accident.

- **Never leave the fresh air fan turned off or use the air recirculation for long periods of time; the air in the vehicle interior will not be refreshed.** ■

Operating by using the Easy Connect* system (valid for Radio Entry)

In the Easy Connect system it is also possible to perform various adjustments to the Climatronic.

Open the air conditioner menu

- Press the **(Setup)** button
- **ALTERNATIVELY:** press the **(MENU)** button in Easy Connect. With the rotating switch select the **air conditioner** menu and open it.

On the screen you can see and change the current settings, for example, the temperature set for the driver side and for that of the passenger. ▶

To switch a function on or off, or to select a submenu, you must press the corresponding function button.

For more information about functions ⇒ page 79.

Function button	Function
OFF	Switch off and switch on the Climatronic.
SETTINGS	The air conditioning settings submenu is opened. It is possible to make the following adjustments: Function button Air conditioning profile : to adjust the level of the fan in AUTO mode. You can choose between low, medium and high. Function button Automatic air recirculation to switch on and off automatic air recirculation ⇒ page 141. BACK function button to close the submenu.

Function button	Function
Air conditioning profile	Adjust the fan level in AUTO mode. You can choose between low, medium and high.
OFF	Climatronic is switched off.
ON	Climatronic is switched on.
SETTINGS	The air conditioning settings submenu is opened. It is possible to make the following adjustments: Function button Air conditioning profile : to adjust the level of the fan in AUTO mode. You can choose between low, medium and high. Function button Automatic air recirculation to switch on and off automatic air recirculation ⇒ page 141. BACK function button to close the submenu.

Operating by using the Easy Connect* system (valid for Standard Radio)

In the Easy Connect system it is also possible to perform various adjustments to the Climatronic.

Open the air conditioner menu

- Press the [Setup](#) button









On the top of the screen you can see and change the current settings, such as, for example, the temperature set for the driver side and for that of passenger. Temperatures up to +22 °C (+72 °F) are shown with blue arrows, and temperatures over +22 °C (+72 °F) with red arrows.

To switch a function on or off, or to select a submenu, you must press the corresponding function button.

Manual air conditioning controls



Fig. 82 In the centre console: Manual air conditioning controls

Control button	Additional information. Manual air conditioning system.
① Temperature ■ ... ■	Rotate the control to set the temperature accordingly.
② Fan 	Setting 0: fan and manual air conditioning switched off, level 6: maximum fan level
③ Air distribution 	Rotate the continuous control to direct the airflow to the desired area.
	Defrost function. The airflow is directed at the windscreen. In this position, air recirculation is automatically switched off or is not switched on. Increase the fan power to clear the windscreen of condensation as soon as possible. To dehumidify the air, the cooling system will automatically switch on.
	The air is directed at the chest of driver and passengers by the dash panel air vents.
	Distribution of air towards the chest and the footwell area.
	Air distribution towards the footwell.
	Air distribution towards the windscreen and the footwell.
	Heated rear window: this only works when the engine is running and switches off automatically after a maximum of 10 minutes.
	Air recirculation ⇒ page 141.

Control button	Additional information. Manual air conditioning system.
	Buttons for seat heating ⇒ page 126.
A/C MAX	Turn the control to the position A/C MAX to make maximum cooling capacity available. Air recirculation and the cooling system are turned on automatically.

WARNING











Stuffy or used air will increase fatigue and reduce driver concentration possibly resulting in a serious accident.

- Never leave the fresh air fan turned off or use the air recirculation for long periods of time; the air in the vehicle interior will not be refreshed.

Heating system and fresh air controls



Fig. 83 In the centre console: heating system and fresh air controls

Control button	Additional information. Heating and fresh air system
 <p>① Temperature</p>	Rotate the control to adjust the temperature accordingly. The desired temperature for the interior cannot be lower than that of the exterior air temperature, as the heating and fresh air system cannot cool or dehumidify the air.
 <p>② Fan</p>	Setting 0: fan, heating and fresh air systems switched off, level 6: maximum fan level.
 <p>③ Air distribution</p>	Rotate the continuous control to direct the airflow to the desired area.
	The airflow is directed at the windscreen.
	The air is directed at the chest of driver and passengers by the dash panel air vents.
	Distribution of air towards the chest and the footwell area.
	Air distribution towards the footwell.
	Air distribution towards the windscreen and the footwell.
	Heated rear window: this only works when the engine is running and switches off automatically after a maximum of 10 minutes.
	Air recirculation => page 141.

Setting for conditions of optimal visibility

- Disable air recirculation mode.
- Set the fan ② to setting 1 or 2.
- Turn the temperature control ① to the desired position.

- Open and direct all the air outlets in the dash panel.
- Turn the air distribution control ③ to the desired position.

WARNING

Stuffy or used air will increase fatigue and reduce driver concentration possibly resulting in a serious accident.

- **Never leave the fresh air fan turned off or use the air recirculation for long periods of time; the air in the vehicle interior will not be refreshed.**

Instructions for use of the air conditioner

The interior cooling system only works when the engine is running and fan is switched on.

The air conditioner operates most effectively with the windows and the panoramic sliding sunroof closed. However, if the vehicle has heated up after standing in the sun for some time, the air inside can be cooled more quickly by opening the windows and the panoramic sliding sunroof briefly.

Setting for conditions of optimal visibility

When the air conditioning is switched on, the temperature and the air humidity in the vehicle interior drop. Hence, when the outside air humidity is high, the windows do not mist over and comfort for the vehicle occupants is improved:

With manual air conditioning

- Switch off air recirculation.
- Set the fan to the required setting.
- Turn the temperature control to the centre position.
- Open and direct all the air outlets in the dash panel.

- Turn the air distribution control to the required position.
- Press the button **(A/C)** to switch on the cooling system. The button will light up.

With Climatronic

- Press button **(AUTO)**.
- Set the temperature to +22 °C (+72 °F).
- Open and direct all the air outlets in the dash panel.

Climatronic: change the temperature unit on the screen of the radio or on the factory-fitted navigation system

Changing the temperature display from Celsius to Fahrenheit on radio or on the factory-fitted navigation system is done using the menu on the instrument panel ⇒ page 73.

The cooling system cannot be activated

If the air conditioning system cannot be switched on, this may be caused by the following:

- The engine is not running.
- The fan is switched off.
- The air conditioner fuse has blown.
- The outside temperature is lower than approximately +3 °C (+38 °F).
- The air conditioner compressor has been temporarily switched off because the engine coolant temperature is too high.
- Another fault in the vehicle. Have the air conditioner checked by a specialised workshop.

Special Characteristics

If the humidity and temperature outside the vehicle are high, **condensation** can drip off the evaporator in the cooling system and form a pool underneath the vehicle. This is normal and does not indicate a leak!

i Note

After starting the engine, any residual humidity in the air conditioner could mist over the windscreen. Switch on the defrost function as soon as possible to clear the windscreen of condensation. ■

Air vents

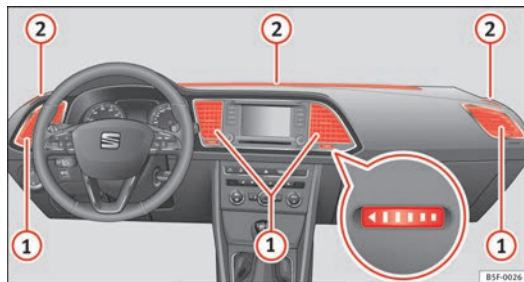



Fig. 84 On the dash panel: air vents

Air vents

To ensure proper heating, cooling and ventilation in the vehicle interior, air vents ⇒ Fig. 84 **1** should remain open.

- Turn the corresponding thumbwheel (detail) in the required direction to open and close the air vents. When the thumbwheel is in the ► position, the corresponding air vent is closed.
- Change the air direction using the ventilation grille lever. ▶

There are other additional, non-adjustable air vents in the dash panel , in the footwell and in the rear area of the interior.



Note

Never place food, medicines or other heat-sensitive objects close to the air vents. Food, medicine and other heat or cold sensitive objects may be damaged or made unsuitable for use by the air coming from the air vents. ■

Air recirculation

Basic points



Air recirculation:



Manual air recirculation (heating and fresh air system, manual air conditioning).

Air recirculation mode prevents the ambient air from entering the interior.

When the outside temperature is very high, selecting manual air recirculation mode for a short period refreshes the vehicle interior more quickly.

For safety reasons, air recirculation mode is switched off when the button  is pressed or the air distributor turned to .

Switching on and switching off manual air recirculation with air conditioner (manual) or with the heating and fresh air systems

Activate: press the button  until the warning lamp lights up.

Deactivate: press the button  until all warning lamps switch off.

Switching on and off manual air recirculation with Climatronic

Activate: press the * button until the warning lamp lights up.

Deactivate: press the * button until all warning lamps switch off.

Functioning mode of manual air recirculation (air conditioning menu)

With the automatic air recirculation mode activated, the entry of fresh air into the cabin interior is enabled. If the system detects a high concentration of hazardous substances in the ambient air, air recirculation mode is switched on automatically. When the level of impurities drops to within a normal range, recirculation mode is switched off.

The system is unable to detect unpleasant smells.

Air recirculation mode is **not** automatically switched on in the following cases of outside temperatures and conditions:

- The cooling system is switched on (the * button lamp is on) and the ambient temperature is below +3 °C (+38 °F).
- The cooling system and the windscreen wipers are switched off and the outside temperature is below +10 °C (+50 °F).
- The cooling system is switched on, the outside temperature is below +15 °C (+59 °F) and the windscreen wipers are switched on.

Activation/deactivation of automatic air recirculation is done in the air conditioner menu, under Configuration.



WARNING

Stuffy or used air will increase fatigue and reduce driver concentration possibly resulting in a serious accident.

- **Never use recirculation mode for long periods as it does not refresh the air inside the vehicle.**
- **If the cooling system is switched off and air recirculation mode switched on, the windows can mist over very quickly, considerably limiting visibility.**
- **Switch air recirculation mode off when it is not required.**

**CAUTION**

Do not smoke when air recirculation is switched on in vehicles with an air conditioner. The smoke taken in could lie on the cooling system vaporiser and on the activated charcoal cartridge of the dust and pollen filter, leading to a permanently unpleasant smell.

**Note**

Climatronic: Air recirculation mode switches on to prevent exhaust gas from entering the vehicle interior when it is in reverse and while the automatic windscreen wash and wipe is working. ■

Driving

Steering

Adjusting the steering wheel position

The height and reach of the steering wheel can be freely adjusted to suit the driver.

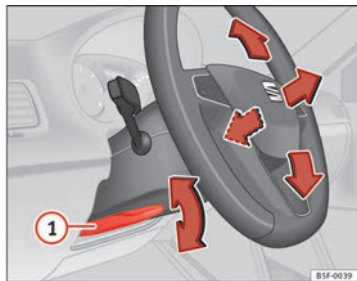

Fig. 85 Lever in the lower left side of the steering column

- Press the lever ① ⇒ Fig. 85 down ⇒ ⚠
- Move the steering wheel to the desired position.
- Move the lever up, applying pressure until the close position is reached.



WARNING

- Never adjust the position of the steering wheel when the vehicle is moving, as this could cause an accident.
- Move the lever up firmly so the steering wheel position does not accidentally change during driving. risk of accident!
- Make sure you are capable of reaching and holding the upper part of the steering wheel, while your back remains well supported by the backrest: risk of accident!

Ignition lock

Starting the engine with the ignition key

Switch on the ignition with the key in the ignition and start the engine.

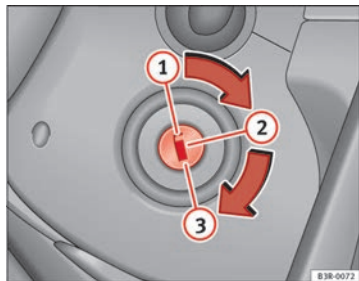

Fig. 86 Ignition key positions

Steering wheel lock

- To lock the steering wheel, remove the key from the ignition and turn the wheel until it locks. In vehicles with the automatic gearbox*, the selector lever must be in the position P in order to remove the key.
- To unlock the steering wheel, insert the key into the ignition and simultaneously turn the key (in the direction of the arrow) and the steering wheel.

Warning: If the steering wheel cannot be turned, this is because the steering wheel lock is activated.

Switching the ignition on/off, preheating

- Turn the ignition key to position ② to switch on the ignition.
- Turn the ignition key to position ① to switch off the ignition.

Preheating is produced in Diesel vehicles ☞ when the ignition is switched on.

Starting up the engine

- *Manual gearbox:* Press the clutch pedal all the way down and move the gearbox lever into neutral.
- *Automatic gearbox:* Press the brake pedal and move the selector lever to position P or N.
- Turn the ignition key to position ③. The key returns to position ② automatically. Do not press the accelerator.

Diesel engines can take a few seconds longer than usual to start on cold days. Therefore the clutch pedal (manual gearbox) or the brake pedal (automatic gearbox) must remain pressed until the engine starts up. During preheating, the warning lamp ☞ remains lit.

The preheating time depends on the coolant and exterior temperatures. When the engine is at operating temperature or at outside temperatures above +8 °C (46 °F) the warning lamp ☞ will only light up for about one second. This means that the engine starts *immediately*.

If the engine does not immediately start up, interrupt the starting process and try again after 30 seconds. To start the engine again, return the key to position ①. ▶

Start-Stop System*

If the vehicle is stopped and the Start-Stop system* switches off the engine, the ignition remains switched on.

Automatic gearbox: Before leaving the vehicle, make sure that the ignition is switched off and the selector lever is in position P.

Driver messages on the instrument panel display

Press the clutch

This message appears on vehicles with a manual gearbox if the driver tries to start the engine without having the clutch pedal pressed. The engine will only start if you press the clutch pedal.

Press the brake

This message appears on vehicles with an automatic gearbox if the driver tries to start the engine without having the brake pedal pressed.

Select N or P

This message appears if you try to start or stop the engine when the selector lever of the automatic gearbox is not in position P or N. The engine can only start or stop in these positions.

Engage position P; the vehicle can move; doors can only close in position P.

For safety reasons, this driver message appears and an audible warning sounds if the selector lever of the automatic gearbox is not in position P after you switch off the ignition. Otherwise the vehicle could move.

Gear change: selector lever in the drive position!

This driver message is displayed and a buzzer is sounded when the selector lever is not in the position P when the driver door is opened. Put the selector lever in position P; otherwise the vehicle can roll away.

Ignition is switched on

This driver message is displayed and a buzzer is sounded when the driver door is opened with the ignition switched on.



WARNING

- Never run the engine in confined spaces, as the exhaust gases are poisonous.
- Never remove the key from the ignition if the vehicle is in motion. Otherwise, the steering could suddenly lock, making it impossible to steer the vehicle: risk of accident!
- Always take the key with you when you leave the vehicle. This is particularly important if there are children in the vehicle, as they might otherwise be able to start the engine or use power-operated equipment (e.g. the electric windows), which could cause injuries.



CAUTION

Avoid high engine speeds, full throttle and extreme load conditions until the engine has reached its normal operating temperature, otherwise this can damage the engine.



For the sake of the environment

Do not warm up the engine by running it with the car stationary. You should drive off as soon as you start the engine. This will help avoid unnecessary exhaust emissions.



Note

- If it is difficult to turn the ignition key to the position ①, turn the steering wheel to both sides to release the steering lock.
- When starting from cold, the engine may be a little noisy for the first few seconds until oil pressure has built up in the hydraulic valve lifters. This is quite normal, and no cause for concern.
- If the vehicle battery is disconnected and reconnected, the key must remain in the position ① for around 5 seconds before starting up.
- Vehicles with automatic gearbox: After switching off the ignition, you can only remove the ignition key if the selector lever is in position "P" (parking lock). Next, the selector lever is locked. ■

Switching off the engine with the key

Switching off the engine

- Stop the vehicle.
- Turn the ignition key to position 0.

Engaging the steering wheel lock

Important: selector lever (automatic gearbox*) must be in position P.

- Remove the key from the ignition in position 1 ⇒ Fig. 86 ⇒ ⚠.
- Turn the steering wheel until you hear it engage.

Possible vehicle theft is prevented with the steering lock engaged.

WARNING

- Never switch the engine off until the vehicle is stationary. The brake servo and power steering functions will not be completely covered under warranty. More force may also be needed to turn the steering wheel or to brake. As you cannot steer and brake in the normal manner, there is a greater risk of accidents and serious injury.
- Never remove the key from the ignition if the vehicle is in motion. Otherwise, the steering could lock making it impossible to steer the vehicle.
- Always take the ignition key with you whenever you leave the vehicle, even temporarily. This is particularly important if there are children in the vehicle, as they might otherwise be able to start the engine or use power-operated equipment (e.g. the electric windows), which could cause injuries.

CAUTION

If the engine has been running under high load for a long time, there is a risk of heat building up in the engine compartment after the engine has been switched off; this could cause engine damage. For this reason, you should idle the engine for approx. 2 minutes before you switch it off.

Note

- After the engine is switched off the radiator fan may run on for up to 10 minutes, even if the ignition is switched off. It is also possible that the fan turns itself on once more if the coolant temperature increases due to the heat accumulated in the engine compartment or due to its prolonged exposure to solar radiation.
- If the vehicle is stopped and the Start-Stop system* switches off the engine, the ignition remains switched on. Make sure that the ignition is switched off before leaving the vehicle, otherwise the battery could discharge.

Kick-down

The kick-down feature allows maximum acceleration to be reached.

If the eco* ⇒ page 172 mode has been selected in SEAT Drive Mode*, and the accelerator is pressed beyond a hard point, the engine power is automatically controlled to give your vehicle maximum acceleration.

WARNING

Please note that if the road surface is slippery or wet, the kick-down feature could cause the driving wheels to spin, which could result in skidding.

Handbrake

Using the handbrake

The handbrake should be applied firmly to prevent the vehicle from accidentally rolling away.



Fig. 87 Handbrake between the front seats

Always apply the handbrake when you leave your vehicle and when you park.

Applying the handbrake

- Pull the handbrake lever up firmly ⇒ Fig. 87.

Releasing the handbrake

- Pull the lever up slightly and press the release knob in the direction of the arrow ⇒ Fig. 87 and guide the handbrake lever down fully ⇒ ⚠.

Always apply the handbrake *as far as it will go* in order to prevent yourself from driving with the handbrake applied by mistake ⇒ ⚠.

The handbrake warning lamp  lights up when the handbrake is applied and the ignition switched on. The warning lamp turns off when the handbrake is released.

If you drive faster than 6 km/h (4 mph) with the handbrake on, the following message* will appear on the instrument panel display: **HANDBRAKE ON**. You will also hear an audible warning.

WARNING

- Never use the handbrake to stop the vehicle when it is in motion. The braking distance is considerably longer, because braking is only applied to the rear wheels. Risk of accident!
- If the handbrake is only partially released, this will cause the rear brakes to overheat, which can impair the function of the brake system and could lead to an accident. This also causes premature wear on the rear brake pads.

CAUTION

Always apply the handbrake before you leave the vehicle. The first gear should also be selected. ■

Parking

The handbrake should always be firmly applied when the vehicle is parked.

Always note the following points when parking the vehicle:

- Use the brake pedal to stop the vehicle. ▶

- Apply the handbrake.
- Select first gear.
- Switch the engine off and remove the key from the ignition. Turn the steering wheel slightly to engage the steering lock.
- Always take your keys with you when you leave the vehicle ⇒ ⚠.

Additional notes on parking the vehicle on gradients:

Turn the steering wheel so that the vehicle rolls against the kerb if it started to roll.

- If the vehicle is parked facing **downhill**, turn the front wheels so that they point *towards the kerb*.
- If the vehicle is parked facing **uphill**, turn the front wheels so that they point *away from the kerb*.
- Secure the vehicle as normal by applying the handbrake firmly and selecting first gear.



WARNING

- Take measures to reduce the risk of injury when you leave your vehicle unattended.
- Never park where the hot exhaust system could ignite inflammable materials, such as dry grass, low bushes, spilt fuel etc.
- Never allow vehicle occupants to remain in the vehicle when it is locked. They would be unable to open the vehicle from the inside, and could become trapped in the vehicle in an emergency. In the event of an emergency, locked doors will delay assistance to vehicle occupants.
- Never leave children alone in the vehicle. They could set the vehicle in motion, for example, by releasing the handbrake or the gearbox lever.
- Depending on weather conditions, it may become extremely hot or cold inside the vehicle. This can be fatal.

Hill hold assist*

The Hill hold assist facilitates moving off when driving uphill.

Important: the driver door must be closed, the seat belt fastened and the engine running.

The system is activated when you press and hold the brake pedal for a **few seconds**.

To prevent the vehicle from rolling backwards when moving off, the brake force will remain for a moment after releasing the brake pedal. This short space of time is enough to start the vehicle with ease.



WARNING

- The smart technology included in the Hill hold assist cannot defy the laws of physics. Do not let the extra convenience afforded by the Hill hold assist tempt you into taking any risks when driving.
- The Hill hold assist cannot maintain the vehicle stationary on a slope in all situations (e.g. on slippery or icy ground).
- If you do not start the vehicle immediately after taking your foot off the brake pedal, the vehicle may start to roll back under certain circumstances. Depress the brake pedal or use the handbrake immediately.
- If the engine stalls, depress the brake pedal or use the handbrake immediately.
- If you are moving off on a slope in stop-and-go traffic, press and hold the brake pedal for a few seconds before driving off. This will prevent the vehicle from rolling back unintentionally.





Note

The SEAT Official Service or a specialised workshop can tell you if your vehicle is equipped with the Hill hold assist.

Speed warning function

Introduction

The speed warning function can help prevent you exceeding a particular pre-set maximum speed.

The speed warning function will warn the driver if a pre-set maximum speed is exceeded. The system gives a warning buzzer signal if the set speed is exceeded by about 3 km/h (2 mph). The warning lamp  and the driver message **Speed limit exceeded!** will be displayed simultaneously on the instrument panel display. The warning lamp  switches off when reducing speed below the stored maximum limit.

You are recommended to store this speed limit warning if you always wish to be reminded of a particular speed limit. This could be when driving in countries with general speed limits, or if a particular speed should not be exceeded when winter tyres are fitted etc.



Note

- Please bear in mind that, even with the speed warning function, it is still important to keep an eye on the vehicle speed with the speedometer and to observe the legal speed limits.
- The speed limit warning function in the version for several countries warns you at a speed of 120 km/h (80 mph). This is a factory-set speed limit.

Setting speed limit warning

You can use the radio or the Easy Connect to set, alter or cancel the speed limit warning.*

Vehicles with radio

- Select: **SETUP** button > control button  **Driver assistant** > **Speed warning**.

Vehicles with Easy Connect

- Select: **Systems** control button or **Vehicle systems** > **Driver assistant** > **Speed warning**.

The warning limit can be set from 30 to 240 km/h (20 to 150 mph). The adjustment is done in 10 km/h (mph) intervals. ■

Start-Stop system*

Description and operation

The Start-Stop system helps save fuel and reduce CO₂ emissions.

In Start-Stop mode, the engine will automatically switch off when the vehicle stops, when stopping at traffic lights for example. The ignition remains switched on during the stopping phase. The engine automatically switches back on when required.

As soon as the ignition is switched on, the Start-Stop function is automatically activated. ►

Basic requirements for the Start-Stop mode

- The driver door must be closed.
- The driver must have their seat belt fastened.
- The bonnet must be closed.
- The vehicle must have travelled at more than 4 km/h (2 mph) since the last stop.
- The vehicle cannot be towing a trailer.



WARNING

- **Never switch the engine off until the vehicle is stationary. The brake servo and power steering functions will not be completely covered under warranty. More force may also be needed to turn the steering wheel or to brake. As you cannot steer and brake in the normal manner, there is a greater risk of accidents and serious injury.**
- **Never remove the key from the ignition if the vehicle is in motion. Otherwise, the steering could lock making it impossible to steer the vehicle.**
- **Always take the ignition key with you whenever you leave the vehicle, even temporarily. This is particularly important if there are children in the vehicle, as they might otherwise be able to start the engine or use power-operated equipment (e.g. the electric windows), which could cause injuries.**
- **To avoid injury, make sure that the Start-Stop system is switched off when working in the engine compartment ⇒ page 152.**



CAUTION

The Start-Stop system must always be switched off when driving through flooded areas ⇒ page 152.

Stop/Start the engine

Vehicles with a manual gearbox

- When the vehicle is stopped, put it into neutral and release the clutch pedal. The engine will switch off. The warning lamp (A) will appear on the instrument panel display.
- When the clutch pedal is pressed the engine will start up again. The warning lamp will switch off.

Vehicles with an automatic gearbox

- Use the foot brake to bring the vehicle to a stop and keep the brake pedal pressed down with your foot. The engine will switch off. The warning lamp (A) will appear in the display.
- When you take your foot off the brake pedal the engine will start up again. The warning lamp will switch off.

Additional information related to the automatic gearbox

The engine stops when the selector lever is in the positions P, D, N and S, in addition to when in manual mode. With the selector lever in position P, the engine will also remain switched off when you take your foot off the brake pedal. In order to start the engine up again the accelerator must be pressed, or another gear engaged or the brake released.

If the selector lever is placed in position R during the stopping phase, the engine will start up again.

Change from position D to P to prevent the engine from accidentally starting when changing and passing by position R. ▶

**Note**

- You can control whether the engine should switch off or not by reducing or increasing the brake force applied. While the vehicle remains stopped, the engine will not stop if the brake pedal is slightly pressed, in traffic jams with frequent stopping and starting for example. As soon as strong pressure is applied to the brake pedal, the engine will stop.
- In vehicles with manual gearbox, during the stopping phases the brake pedal must remain depressed to prevent the vehicle from moving.
- If the engine stalls in vehicles with manual gearbox, it can be directly started up again by immediately pressing the clutch pedal.

General notes

The system can interrupt the Start-Stop mode frequently for different reasons.

The engine does not switch off

Before the stopping phase, the system verifies whether certain conditions are met. The engine **does not** switch off, in the following situations for example:

- The engine has not yet reached the minimum required temperature for the Start-Stop mode.
- The interior temperature selected for the air conditioner has not yet been reached.
- The interior temperature is very high/low.
- Defrost function button activated ⇒ page 135.
- The parking aid* is switched on.
- The battery is very low.
- The steering wheel is overly turned or is being turned.
- If there is a danger of misting.

- After engaging reverse gear.
- In case of a very steep gradient.

The indication  is shown on the instrument panel display, and in addition, the driver information system* shows, ^{START} ^{STOP}.

The engine starts by itself

During a stopping phase the normal Start-Stop mode can be interrupted in the following situations: The engine restarts by itself without involvement from the driver.

- The interior temperature differs from the value selected on the air conditioner.
- Defrost function button activated ⇒ page 135.
- The brake has been pressed several times consecutively.
- The battery is too low.
- High power consumption.

**Note**

In vehicles with an automatic gearbox, if the selector lever is placed in position D, N or S after engaging reverse gear, the vehicle must be driven at a speed faster than 10 km/h (5 mph) for the system to return to conditions in which the engine can be stopped.

Manually switching on/off the Start-Stop system

If you do not wish to use the system, you can switch it off manually.



Fig. 88 Centre console: Start-Stop system button

- To manually switch on/off the Start-Stop system, press the button . The button symbol remains lit up yellow when the system is switched off.

Note

The system is automatically switched on each time the engine is deliberately stopped during a stopping phase. The engine will start automatically. ■

Driver messages on the instrument panel display

Start-Stop system deactivated. Start the engine manually

This driver message is displayed when certain conditions are not met during the stopping phase and the Start-Stop system **cannot** restart the engine. The engine must be started manually.

Start-Stop system: Fault! Function not available

There is a fault in the Start-Stop system. Take the vehicle to a workshop to have the fault repaired. ■

Manual gearbox

Changing gears

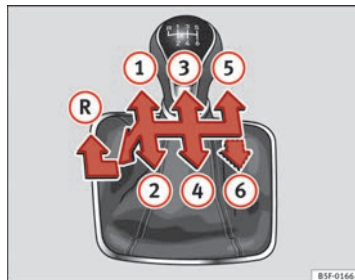

Fig. 89 Gear shift pattern of a 5 or 6-speed manual gearbox

The position of each of the gears is shown on the gear stick → Fig. 89. ►

- Press and hold the clutch pedal to the floor.
- Place the gearbox lever in the required position ⇒ ⚠.
- Release the clutch pedal to engage clutch.

In some countries the clutch pedal must be fully pressed down for the engine to start.

Selecting reverse gear

- Engage reverse gear only when the vehicle is stopped.
- Press and hold the clutch pedal to the floor ⇒ ⚠.
- Move the gearbox lever into the neutral position and press it down.
- Move the gearbox lever completely to the left and then forwards to position it in reverse gear ⇒ Fig. 89 (R).
- Release the clutch pedal to engage clutch.

Changing down gears

While driving, changing down a gear must always be done gradually, i.e. to the gear directly below and when the engine speed is not too high ⇒ ⚠. Changing down while bypassing one or various gears at high speeds or at high engine speeds can damage the clutch and the gearbox, even if the clutch pedal remains depressed ⇒ Ⓣ.

Kick-down

In vehicles with a speed limiter, the kick-down function enables the programmed speed to be exceeded deliberately, i.e. when overtaking.

When the accelerator is pressed to the floor, the speed limiter is temporarily deactivated as the programmed speed is exceeded.

When the speed of the vehicle falls below the programmed value again, and when the accelerator is not pressed to the floor, the speed limiter is reactivated.



WARNING

When the engine is running, the vehicle will start to move as soon as a gear is engaged and the clutch released. This is also the case with the electro-mechanical parking brake switched on.

- **Never engage reverse gear when the vehicle is moving.**



WARNING

If the gear is changed down inappropriately by selecting a gear that is too low, you may lose control of the vehicle, causing an accident and serious injuries.



CAUTION

When travelling at high speeds or at high engine speeds, selecting a gear that is too low can cause considerable damage to the clutch and the gearbox. This can also occur if the clutch pedal is pressed and held and it does not engage.



CAUTION

To prevent damage and avoid premature wear, please observe the following:

- Do not rest your hand on the gear lever while driving. The pressure applied by your hand is transmitted to the gearbox selector forks.
- Always ensure that the vehicle is completely stopped before engaging the reverse gear.
- Always press the clutch to the floor when changing gears.
- Never hold the vehicle "on the clutch" on hills with the engine on. ■

Automatic gearbox/DSG automatic gearbox*

Introduction

Your vehicle is equipped with an electronically controlled manual gearbox. Torque between the engine and the gearbox is transmitted via two independent clutches. They replace the torque converter found on conventional automatic gearboxes and allow for smooth, uninterrupted acceleration of the vehicle.

The **tiptronic** system allows the driver to change gears *manually* if desired ⇒ page 159, Changing gears in tiptronic mode*.

Selector lever positions

The selector lever position engaged is highlighted on the display in the instrument cluster. With the selector lever in the manual gearbox positions G, D, E and S, the engaged gear is also indicated on the display.

P – Parking lock

When the selector lever is in this position, the driven wheels are locked mechanically. The parking lock must be engaged only when the vehicle is *stationary* ⇒ .

The interlock button (the button on the selector lever handle) must be pressed in *and* simultaneously the brake pedal must be depressed before moving the selector lever either in or out of position P.

R – Reverse gear

Reverse gear must be engaged only when the vehicle is *stationary* and the engine is idling ⇒ .

To move the selector lever to position R, the interlock button must be pressed in *and* at the same time the brake pedal must be depressed. The reverse

lights come on when the selector lever is in the R position with the ignition on.

N – Neutral (idling)

With the selector lever in this position, the gear is in neutral.

D/S – Permanent drive (forward) position

The selector lever in the D/S position enables the gears to be controlled in normal mode (D) or Sport (S). To select Sport mode (S), move the selector lever backwards. Moving the lever again will select normal mode (D). The selected driving mode is shown on the instrument panel display.

In **normal mode** (D), the gearbox automatically selects the best gear ratio. This depends on the engine load, the road speed and the dynamic gear control programme (DCP).

Sport mode (S) must be selected for a sporty driving style. This setting makes use of the engine's maximum power output. When accelerating the gear shifts will be noticeable.

The brake pedal must be pressed when moving the selector lever from D/S to N if the vehicle is stationary or at speeds below 5 km/h (3 mph) ⇒ .

Under certain circumstances (e.g. when driving in mountains) it can be advantageous to switch temporarily to tiptronic mode ⇒ page 159, in order to *manually* select gear ratios to suit the driving conditions.



WARNING

- Take care not to accidentally press the accelerator pedal when the vehicle is stopped. The vehicle could otherwise start moving immediately (in some cases even if the parking brake is engaged) resulting in the risk of an accident.
- Never move the selector lever to R or P when driving. Failure to do so could result in an accident.

⚠ WARNING (Continued)

- With selector lever in any position (except P) the vehicle must always be held with the foot brake when the engine is running. This is because an automatic gearbox still transmits power even at idling speed, and the vehicle tends to "creep". The accelerator pedal must on no account be pressed inadvertently when a gear is engaged with the vehicle stationary. The vehicle could otherwise start moving immediately (in some cases even if the parking brake is engaged) resulting in the risk of an accident.
- While you are selecting a gear and the vehicle is stopped with the engine running, do not accelerate. Failure to do so could result in an accident.
- As a driver you should never leave your vehicle if the engine is running and a gear is engaged. If you have to leave your vehicle while the engine is running, you must apply the handbrake and engage the parking lock P.
- To avoid accidents, apply the handbrake and put the selector lever in position P before opening the bonnet and working on the vehicle with the engine running. Please always observe the important safety warnings ⇒ page 209, Working on components in the engine compartment.



Note

- If the selector lever is moved accidentally to N when driving, release the accelerator and let the engine speed drop to idling before selecting gear range D or S again.
- Should the power supply to the selector lever be interrupted in position P, the selector lever will be locked. If this should happen the manual release can be used ⇒ page 163.

Selector lever lock

The selector lever lock prevents gears from being engaged inadvertently, so that the vehicle is not set in motion unintentionally.



Fig. 90 Selector lever lock

The selector lever lock is released as follows:

- Switch the ignition on.
- Press the brake pedal *and* at the same time press in the interlock button.

Automatic selector lever lock

With the ignition switched on, the selector lever is locked in the positions P and N. The brake pedal must be pressed to release the lever while pressing the release button if the selector lever is in the position P. As a reminder for the driver, with the lever in positions P or N the following message will be shown on the display:

When stationary, apply footbrake while selecting a gear.

The selector lever lock only works if the vehicle is stationary or driving at speeds up to 5 km/h (3 mph). At higher speeds the selector lever lock in the N position is disengaged automatically.

The selector lever lock is not engaged if the selector lever is moved quickly through position N (e.g. when shifting from R to D). This makes it possible, for instance, to rock the vehicle backwards and forwards if it is stuck. The selector lever lock engages automatically if the brake pedal is not depressed and the lever is in position N for more than about two seconds.

Interlock button

The interlock button on the selector lever handle prevents the driver from inadvertently engaging certain gears. Press the button in to disengage the selector lever lock. The selector lever positions in which the interlock button has to be pressed are shown in the illustration, highlighted in colour → Fig. 90.

Safety interlock for ignition key

Once the ignition has been turned off, the key may be removed only if the gear selector is in position P. While the key is not in the ignition, the selector lever is locked in position P.



Note

- If the selector lever lock does not engage, there is a fault. The transmission is interrupted to prevent the vehicle from accidentally moving. Follow the procedure below in order for the selector lever lock to engage again:
 - ›With a 6-speed gearbox: press the brake pedal and release it again.
 - ›With a 7-speed gearbox: press the brake pedal. Move the selector lever to position P or N and subsequently engage a gear.
- Despite a gear being engaged, the vehicle does not move forwards or back. Proceed to the next mode:

- When the vehicle does not move in the required direction, the system may not have the gear range correctly engaged. Press the brake pedal and engage the gear range again.
- If the vehicle still does not move in the required direction, there is a system malfunction. Seek specialist assistance and have the system checked. ■

Driving tips

The gearbox changes gear ratios automatically as the vehicle moves.

The engine can only start with the selector lever in the position P or N. At low temperatures, below -10 °C (50 °F), the engine can only start with the selector lever in the position P.

Starting the vehicle

- Press and hold the brake pedal.
- Press and hold the interlock button (the button in the selector lever handle), move the selector lever to the desired position, for instance D ⇒ page 154, and release the interlock button.
- Wait for the gearbox to engage the gear (a slight movement can be felt).
- Release the brake and press the accelerator ⇒ ⚠.

Stopping briefly



- Apply the foot brake to hold the vehicle when stationary (for instance at traffic lights). Do not press the accelerator. ▶

Stopping/Parking

If the driver door is opened and the selector lever is not in position P, the vehicle could move. Driver message:  **Gear change: selector lever in drive position!** will be displayed. Additionally, a buzzer will sound.

- Press and hold the brake pedal ⇒ .
- Apply the handbrake.
- Move the selector lever to position P.

Holding the car on a hill

- *Always* apply the brake pedal firmly to prevent the vehicle from “moving backwards; if necessary, apply the handbrake” ⇒ . Do **not** try to stop the vehicle “rolling back” by increasing the engine speed when a gear is engaged (pressing the accelerator) ⇒ .

Moving off uphill in vehicles without Hill start assistant*

- Apply the handbrake.
- Once you have engaged a gear press the accelerator carefully and disengage the handbrake.

Moving off uphill in vehicles without Hill start assistant*

- Once you have engaged a gear, release the footbrake and press the accelerator ⇒ page 148, Hill hold assist*.

Driving down hills: In some situations (on mountain roads or when towing a trailer or caravan) it can be advantageous to switch temporarily to the manual gearbox programme so that the gear ratios can be selected manually to suit the driving conditions ⇒ .



On level ground it is sufficient to move the selector lever to position P. On slopes, first engage the parking brake and then put the selection lever into the P position. This avoids overloading the locking mechanism and it will be easier to move the selector lever from position P.



WARNING

- As a driver you should never leave your vehicle if the engine is running and a gear is engaged. If you have to leave your vehicle while the engine is running, you must apply the handbrake and engage the parking lock P.
- If the engine is running and a gear is engaged (D/S or R) or the vehicle is in tiptronic mode, you will need to hold the car with the footbrake. Otherwise, the car will creep forwards as the power transmission is not fully interrupted even when the engine is idling.
- Take care not to accidentally press the accelerator pedal when the vehicle is stopped. The vehicle could otherwise start moving immediately (in some cases even if the parking brake is engaged) resulting in the risk of an accident.
- While you are selecting a gear and the vehicle is stopped with the engine running, do not accelerate. Failure to do so could result in an accident.
- Never move the selector lever to R or P when driving: this could result in an accident!
- Before you drive down a steep gradient, reduce your speed and use tiptronic to select a low gear.
- Never allow the brake to rub and do not use the brake pedal too often or for long periods. Constant braking causes overheating in the brakes. This could significantly reduce braking power, increase braking distance or even result in the total failure of the brake system.
- To avoid rolling back on gradients always hold the vehicle with the footbrake or handbrake if you have to stop.

**CAUTION**

- If you stop the vehicle on a gradient, do not attempt to stop it from rolling by depressing the accelerator when a gear has been selected. This could cause overheating and damage the automatic gearbox. Apply the handbrake firmly or press the brake pedal in order to prevent the vehicle from rolling back.
- If you allow the car to roll with the selector lever in position N with the engine switched off, the automatic gearbox will be damaged as it will not be lubricated.
- In certain driving situations or traffic conditions, such as frequently starting, prolonged creeping of the vehicle, or traffic jams with continuous stoppages, the automatic gearbox could overheat causing damage! If the warning lamp  lights up, stop the vehicle as soon as possible and wait for the gearbox to cool ⇒ page 162.
- In certain driving situations or traffic conditions, such as frequently starting, prolonged creeping of the vehicle, or traffic jams with continuous stoppages, the automatic gearbox could overheat causing damage! If the warning lamp  lights up, stop the vehicle as soon as possible and wait for the gearbox to cool ⇒ page 162. ■

Downhill speed control*

The downhill speed control function helps the driver when driving down steep gradients.

Downhill speed control is activated when the selector lever is in D/S and the driver applies the foot brake. The automatic gearbox automatically engages a lower gear that is suitable for the slope. The downhill speed control function attempts to maintain the speed at which the vehicle was travelling when the foot brake was applied (subject to the laws of physics and technical drive limitations). It may be necessary to adjust the speed again using the foot brake in certain situations. Given that the downhill speed control can only change down to 3rd gear, on very steep descents the tiptronic

mode may be required. In this case, manually reduce the tiptronic to 2nd or 1st gear to use the engine brake and reduce the charge on the brakes.

Downhill speed control is deactivated as soon as the road levels out again or you press the accelerator pedal.

On vehicles with cruise control system* ⇒ page 164, downhill speed control is activated when you set a cruising speed.

**WARNING**

The downhill speed control cannot defy the laws of physics. Therefore, speed cannot be maintained constant in all situations. Always be prepared to use the brakes! ■

Changing gears in tiptronic mode*

The tiptronic gives the driver the option to change gears manually.

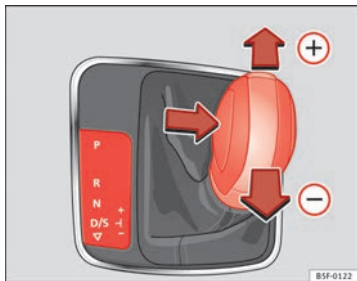

Fig. 91 Centre console: changing gear with Tiptronic



Fig. 92 Steering wheel: automatic gearbox levers

Changing gear manually with the selector lever

It is possible to change to tiptronic mode, both when the vehicle is stopped and while driving.

- To switch to tiptronic mode, move the selector lever from position D/S to the right. As soon as the change is made, the selector lever will be shown in the position **G** (i.e. **G4** means that 4th gear is engaged) on the instrument panel display.
- Move the selector lever forwards **+** to select a higher gear ⇒ Fig. 91.
- Move the selector lever backwards **-** to select a lower gear.

Changing gear manually with the gearshift paddles*

The gearshift paddles can be used when the selector lever is in the position D/S or **G**.

- Press the gearshift paddle **+** to select a higher gear ⇒ Fig. 92.
- Press the gearshift paddle **-** to select a lower gear.
- With the selector lever in position D/S, if no paddle is operated during a short period of time, the gearbox control system switches back to automatic mode. To switch to permanent manual gear change using the gearshift paddles, move the selector lever from position D/S to the right.

When accelerating, the gearbox automatically shifts up into the next gear shortly before the maximum engine speed is reached.

If you select a lower gear, the automatic gearbox will not shift down until there is no risk of overrevving the engine.

When the kick-down feature is used, the gearbox shifts down to a lower gear, depending on road speed and engine speed. ■

Kick-down feature

The kick-down feature allows maximum acceleration to be reached.

When the accelerator pedal is pressed right down past the point of resistance at full throttle, the gearbox will shift down to a lower gear, depending on road speed and engine speed. The upshift to the next higher gear is delayed until the engine reaches maximum rpm.



WARNING



Please note that if the road surface is slippery or wet, the kick-down feature could cause the driving wheels to spin, which could result in skidding.

Launch Control Programme¹⁾

The Launch control programme enables maximum acceleration.

Important: the engine must have reached operating temperature and the steering wheel must not be turned.

The engine speed for Launch control is different on petrol and diesel engines. Before you can use the Launch control, you must first

switch off the traction control system (ASR), either using the Easy Connect system ⇒ page 79, or with the switch  OFF; the warning lamp  will stay on or will flash slowly depending on whether the vehicle has a driver information system*²⁾.

- When the engine is running, switch off the traction control (ASR)^{2) 3)}.
- Move the selector lever to position “S” or tiptronic, or select the driving mode **Sport** from the SEAT Drive Mode* ⇒ page 171.
- Press the brake pedal firmly with your left foot and hold it down for at least one second.
- With your right foot, press the accelerator down to the full throttle or kick-down position. The engine speed will stabilise at approx. **3200** rpm (petrol engine) or approx. **2000** rpm (diesel engine).
- Take your left foot off the brake pedal. ▶

¹⁾ Valid for vehicles: with Launch Control/6-Speed DSG with diesel engines superior to 125 kW and petrol engines superior to 140 kW.

²⁾ On vehicles with the driver information system, the ESP lamp lights up permanently and the corresponding text message **Stability control deactivated** (temporary) appears on the instrument panel to indicate the deactivation status.

³⁾ Vehicles without driver information system: the warning lamp flashes slowly/Vehicles with driver information system: the warning lamp stays on.

 **WARNING**

- Always adapt your driving style to the traffic conditions.
- Only use the Launch control programme when road and traffic conditions permit, and make sure your manner of driving and accelerating the vehicle does not inconvenience or endanger other road users.
- Make sure that the ESC remains switched on. Please note that when the ASR and ESC are deactivated, the wheels may start to spin, causing the vehicle to lose grip. Risk of accident!
- After engaging gear, the Sport mode of the ESC should be deactivated again by briefly pressing the  button.

**Note**

- After using the Launch control programme, the temperature in the gearbox may have increased considerably. In this case, the programme could be disabled for several minutes. The programme can be used again after the cooling phase.
- Accelerating with the Launch control programme places a heavy load on all parts of the vehicle. This can result in increased wear and tear. ■

Inertia mode

The inertia mode enables the kinetic energy of the vehicle to be harnessed enabling certain stretches to be driven without using the accelerator. This enables fuel to be saved. Use the inertia mode to let the vehicle roll in advance of, for example, arriving in a town.

Switching on inertia mode

Important: selector lever must be in position D, gradients below 12 %.

- Select **Eco** mode ⇒ page 171 once in SEAT Drive Mode*.
- Take your foot off the accelerator.

The driver message **Inertia** will be displayed. At speeds higher than 20 km/h (12 mph), the gearbox will automatically disengage and the vehicle will roll freely, without the effect of the engine brake. While the vehicle rolls, the engine runs at idling speed.

Stopping inertia mode

- Press the brake or the accelerator pedal.

To make use of the braking force and switch off the engine again, simply press the brake pedal briefly.

Applying both the **inertia mode** (= prolonged section with less energy) and the **switching off using inertia** (= shorter section without the need for fuel) facilitates improved fuel consumption and emission balance.

 **WARNING**

- If the inertia mode has been switched on, take into account, when approaching an obstacle and releasing the accelerator pedal, that the vehicle will not decelerate in the usual manner: risk of accident!
- When using inertia mode while travelling down hills, the vehicle can increase speed: risk of accident!
- If other users drive your vehicle, warn them about inertia mode. ▶

**Note**

- Inertia mode is only available in **eco** driving mode (SEAT Drive Mode*).
- The driver message **Inertia** is only displayed with the current consumption. In inertia mode the gear will no longer be displayed (for example: E will appear in place of E7).
- On downhill sections with gradients above 15 %, the inertia mode will automatically be switched off temporarily.

Backup programme

A backup programme is in place if a fault should occur in the control system.

If all the positions of the selector lever are shown over a light background on the instrument panel display, there is a system fault and the automatic gearbox will operate in with the backup programme. When the backup programme is activated, it is possible to drive the vehicle, however, at low speeds and within a selected range of gears. In some cases **driving in reverse gear may not be possible**.

**CAUTION**

If the gearbox operates with the backup programme, take the vehicle to a specialised workshop and have the fault repaired without delay.

Clutch

Clutch overheated! Stop the vehicle!

The clutch has overheated and could be damaged. In order to prevent the temperature from increasing again and so that the clutch is cooled, stop the vehicle and wait for the gearbox to cool down with the selector lever in posi-

tion P and the engine running at idling speed. If the warning does not switch off, do not continue driving. Seek specialist assistance. Failure to do so could cause considerable damage to the gearbox. When the warning switches off, the fault should be corrected by a specialised workshop without delay.

Faults in the gearbox

Gearbox: Fault! Stop the vehicle and place the lever in the position P.

There is a fault in the gearbox. Stop the vehicle in a safe place and do not continue driving. Seek specialist assistance.

Overheated clutch! Stop the vehicle!

The clutch has overheated and could be damaged. Stop the vehicle and wait for the gearbox to cool with the engine at idling speed and the selector lever in position P. When the warning lamp and the driver message switch off, have the fault corrected by a specialised workshop without delay. If the warning lamp and the driver message do not switch off, do not continue driving. Seek specialist assistance.

Gearbox: System fault! You may continue driving.

Have the fault corrected by a specialised workshop without delay.

Gearbox: System fault! You can continue driving with restrictions. Reverse gear disabled.

Take the vehicle to a specialised workshop and have the fault repaired without delay.

Gearbox: System fault! You can continue driving in D until switching off the engine

Stop the vehicle in a safe place well away from moving traffic. Seek specialist assistance.

ⓘ **Gearbox: too hot. Adapt your driving accordingly**

Continue driving at moderate speeds. When the warning lamp switches off, you can continue driving in a normal manner.

ⓘ **Gearbox: press the brake and engage a gear again.**

If the fault was caused by a gearbox with a high temperature, this driver message will be displayed when the gearbox has cooled again.

Manual release of the selector lever

The selector lever can be released manually if the electrical power supply should fail.

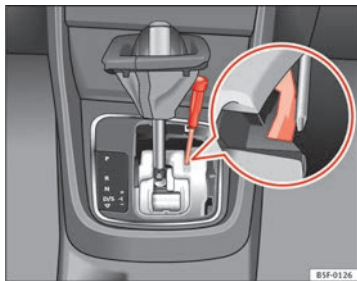

Fig. 93 Selector lever: manual release from position P

The manual release mechanism is located under the selector lever console on the right side. Releasing the selector lever requires a certain degree of practical skill. We therefore advise you to obtain professional assistance.

A screwdriver will be needed to carry out the manual release. Use the flat part of the screwdriver blade ⇒ page 232.

Removing the cover from the selector lever

- Apply the handbrake (E) ⇒ ⚠ to ensure that the car does not move.
- Carefully pull the corners of the selector lever boot and fold up the selector lever boot (inside out) by hand.

Releasing the selector lever

- Using a screwdriver, press and hold the yellow unlocking tab sideways ⇒ Fig. 93.
- Now press the interlock button on the selector lever (A) and move the selector lever to position N.
- After carrying out the manual release, attach the selector lever boot on the gearbox console again.

If the power supply should ever fail (discharged battery, etc.) and the vehicle has to be pushed or towed, the selector lever must first be moved to position N. This is possible after operating the manual release mechanism.

⚠ WARNING

The selector lever may be moved out of position P only when the handbrake is firmly applied. If this does not work, secure the vehicle with the brake pedal. On a slope the vehicle could otherwise start to move inadvertently after shifting the selector lever out of position P - accident risk!

Driver assistance systems

Cruise control system (CCS)*

Introduction

The cruise control system (CCS) is able to maintain the set speed from 20 km/h (15 mph).

A constant speed is maintained using the engine power control or by applying the active brake ⇒ .

Additional information and warnings:

- Change gear ⇒ page 154.
- Accessories and technical modifications ⇒ page 230.

WARNING

Use of the cruise control could cause accidents and severe injuries if it is not possible to drive at a constant speed maintaining the safety distance.

- Do not use the cruise control in heavy traffic, if the distance from the vehicle in front is insufficient, on steep roads, with several bends or in slippery circumstances (snow, ice, rain or loose gravel), or on flooded roads.
- Never use the CCS when driving off-road or on unpaved roads.
- Always adapt your speed and the distance to the vehicles ahead in line with visibility, weather conditions, the condition of the road and the traffic situation.
- To avoid unexpected operation of the cruise control system, turn it off every time you finish using it.

WARNING (Continued)

- It is dangerous to use a set speed which is too high for the prevailing road, traffic or weather conditions.
- When travelling down hills, the CCS cannot maintain a constant speed. The vehicle tends to accelerate under its own weight. Select a lower gear or use the foot brake to slow the vehicle.

Warning and control lamp

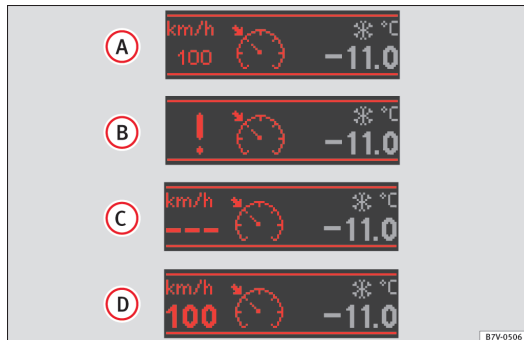



Fig. 94 Instrument panel display: CCS status indications

Control lamp

lights up	Possible cause
	Cruise control is active

Several warning and control lamps should light up for a few seconds when the ignition is switched on, signalling that the function is being verified. They will switch off after a few seconds.

Displayed on the CCS screen

Status Fig. 94:

- A** CCS temporarily switched off. The set speed is displayed in small figures.
- B** System error. Contact a specialised workshop.
- C** CCS switched on. The speed memory is empty.
- D** The CCS is switched on. The set speed is displayed in large figures.



WARNING

If the warning lamps and messages are ignored, the vehicle may stall in traffic, or may cause accidents and severe injuries.

- Never ignore the warning lamps or text messages.



CAUTION

Failure to heed the control lamps and text messages when they appear may result in faults in the vehicle. ■

Operating the cruise control system*

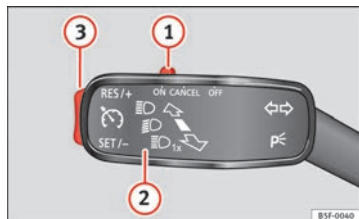

Fig. 95 On the left of the steering column: switches and controls for operating the CCS

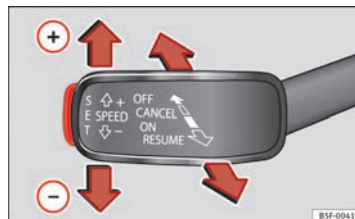

Fig. 96 On the left of the steering column: Third 6-position lever for operating the CCS

Function	Position of the switch, operating the switch on the turn signal lever ⇒ Fig. 95, or by using the third lever ⇒ Fig. 96	Action
Switching on the CCS	Move the switch ① on the turn signal lever to the ON position, or move the third lever to the ON position.	The system is switched on. The system does not maintain the speed because there is still no speed set.
Activating the CCS	Press the SET button on the turn signal lever or press the SET button on the third lever.	The current speed is stored and maintained.
Temporarily switching off the CCS	Move the switch ① on the turn signal lever to the CANCEL position. Move the third lever to the CANCEL position and release it. OR: Apply the foot brake.	The cruise control system is switched off temporarily. The speed setting will remain stored.
Switching on the CCS again	Press the button ③ on the turn signal lever to the RES/+ position, or move the third lever to the RESUME position and release it.	The stored speed will be saved and will regulate again. ▶

Function	Position of the switch, operating the switch on the turn signal lever ⇒ Fig. 95, or by using the third lever ⇒ Fig. 96	Action
Increasing the stored speed (during CCS setting)	Depending on equipment fitted: – briefly press the button ③ on the turn signal lever in the RES zone– or briefly move the third lever to the RESUME position to increase speed by 1 km/h (1 mph) – or move the third lever upwards with SPEED+ to increase the speed by 10 km/h (10 mph) and store it – or continuously press the button ③ on the turn signal lever in the RES zone– or move the third lever upwards with SPEED+ continuously – or move the third lever to the RESUME position and hold it to continuously increase the speed and store it.	The vehicle accelerates actively until it reaches the new stored speed.
Increasing the stored speed	When the CCS is in the ON position, but DEACTIVATED , the speed setting can be increased with SPEED+ by 10 km/h (10 mph).	The vehicle accelerates actively until it reaches the new stored speed.
Reducing the stored speed (during CCS setting)	Depending on equipment fitted: – briefly press the button ③ on the turn signal lever in the SET zone to reduce speed by 1 km/h (1 mph) – or briefly move the third lever to the SET position to reduce the speed by 1 km/h (1 mph) – or move the third lever downwards with SPEED- to reduce the speed by 10 km/h (10 mph) and store it – or continuously press the button ③ on the turn signals lever in the SET zone– or press and hold the button SET on the third lever to reduce speed continuously – or move the third lever downwards (SPEED-) continuously and store it.	Speed is reduced without braking, by interrupting the accelerator until reaching the new stored speed.
Setting a lower speed	When the CCS is in the ON position, but DEACTIVATED , the speed setting can be reduced with SPEED- by 10 km/h (10 mph).	The system is switched off. The stored speed is deleted.
Switching off the CCS	Move the switch ① to the OFF position. OR: move the third lever to the OFF position.	Speed is reduced without intervening in the braking system, by interrupting the accelerator until reaching the new stored speed.

The value indicated in the table in brackets (in mph, miles per hour) only refers to instrument panels with indications in miles.

Changing gear in CCS mode

The CCS decelerates as soon as the clutch pedal is pressed, intervening again automatically after a gear is engaged. ▶

Travelling down hills with the CCS

When travelling down hills the CCS cannot maintain a constant speed. Slow the vehicle down using the brake pedal and reduce gears if required.

Automatic off

The cruise control system (CCS) is switched off automatically or temporarily:

- If the system detects a fault that could affect the working order of the CCS.
- If you press and maintain the accelerator pedal for a certain time, driving faster than the stored speed.
- If the dynamic driving control systems intervene (i.e. ASR or ESC).
- If the airbag is triggered.

Lane Assist system*

Introduction

Additional information and warnings:

- SEAT information system ⇒ page 73
- Accessories, parts replacement, repairs and modifications ⇒ page 230



WARNING

The intelligent technology in the Lane Assist system cannot change the limits imposed by the laws of physics and by the very nature of the system. Careless or uncontrolled use of the Lane Assist system may cause accidents and injury. The system is not a replacement for driver awareness.

- Always adapt your speed and the distance to the vehicles ahead in line with visibility, weather conditions, the condition of the road and the traffic situation.
- Always keep your hands on the steering wheel so it can be turned at any time.
- The Lane Assist system does not detect all road markings. The road surfaces, road structures or objects in poor condition can be incorrectly detected as road markings under certain circumstances by the Lane Assist system. In such situations, switch the Lane Assist system off immediately.
- Please observe the indications on the instrument panel and act as is necessary.
- Always pay attention to the vehicle's surroundings.
- When the area of vision of the camera becomes dirty, covered or is damaged, the Lane Assist system function can be affected.



CAUTION

In order to avoid influencing the operation of the system, the following points must be taken into account:

- Regularly clean the area of vision of the camera and keep it in a clean state, without snow or ice.
- Do not cover the area of vision of the camera.
- Check that the area of vision of the windscreen camera is not damaged. ►

**Note**

- The Lane Assist system has been exclusively developed for driving on paved roads only.
- If the Lane Assist system does not work as described in this chapter, do not use it and contact a specialised workshop.
- If there is a fault in the system, have it checked by a specialised workshop.

Indication on the display and warning lamps

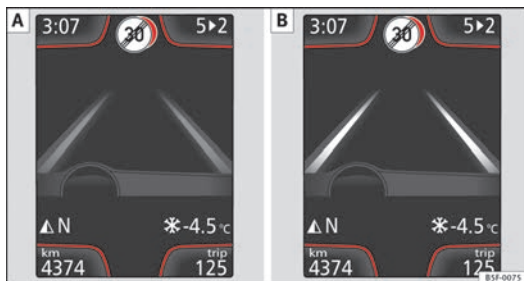

Fig. 97 On the instrument panel display: Indication on the Lane Assist system display (example 1)

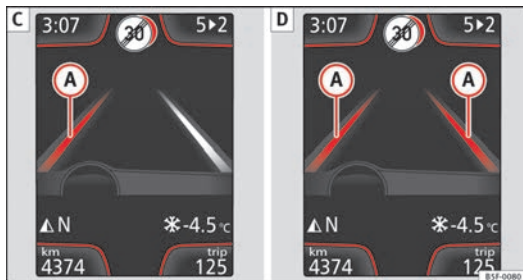



Fig. 98 On the instrument panel display: Indication on the Lane Assist system display (example 2)

Indications on the display

- The system is active, but not available, either because the minimum speed has not been reached or because the lane lines are not recognised ⇒ Fig. 97 [A].
- The system is active and available, both lane lines are recognised. The steering angle is not being corrected at this moment ⇒ Fig. 97 [B].
- The system is operational, a yellow line (A) indicates that there was a risk of involuntarily crossing the lane line and that the steering is being adjusted to correct the angle ⇒ Fig. 98 [C].
- Two yellow lines (A) light up simultaneously when both lane lines are recognised and the Lane Assist function is active ⇒ Fig. 98 [D]. ▶

Control lamps

flashes or lights up	Possible cause	Solution
 (yellow)	Lane Assist active but not available.	The system can not accurately recognise the lane. Please see page 170, The Lane Assist system is not available (the control lamp is lit up yellow).
 (green)	Lane Assist system active and available.	–

Several warning and control lamps light up for a few seconds when the ignition is switched on while the function is verified. They will switch off after a few seconds.

**WARNING**

If the warning lamps and messages are ignored, the vehicle may stall in traffic, or may cause accidents and severe injuries.

- Never ignore the warning lamps or text messages.
- Stop the vehicle safely as soon as possible.

**Note**

Failure to heed the control lamps and text messages when they appear may result in faults in the vehicle.

Operating mode



Fig. 99 In the windscreen: Field of vision of the Lane Assist system camera

Using the camera located in the windscreen, the Lane Assist system detects the possible lines dividing the lanes. When the vehicle involuntarily approaches a dividing line it has detected, the system notifies the driver with a *corrective steering movement*. The corrective steering movement can be overruled at any moment.

No warning is produced with the turn signals activated, given that the Lane Assist system understands that a lane change is required.

Steering wheel vibration

The following situations cause vibration in the steering wheel and require the driver to take active control of driving:

- When the limits of the very nature of the system are reached.
- When the maximum rotational torque during the corrective steering movement is not enough to keep the vehicle inside the lane.
- When no lane is detected during the corrective steering movement. ▶

Switching the Lane Assist system on or off

- The Assistants menu ⇒ page 77 drops down in the instrument panel by pressing the **Assistants** button on the turn signal lever or by operating the menu in the multifunction steering wheel.
- **OR:** by pressing the **OK** button on the steering wheel the ⇒ page 77 function is activated/deactivated.
- The **Lane centring guide** is activated/deactivated in the Easy Connect system using the **CAR** button and the button on the **Setup** function ⇒ page 79.

Self-deactivation: The Lane Assist system can be automatically deactivated if there is a system malfunction. The control lamp disappears.

Hands-Off Function

- If the driver does not exert any physical action on the steering wheel for about 10 to 12 sec. the function deactivates.
- Visual and audible warnings on the instrument panel.
- The function switches off 2 seconds after the warning.

The Lane Assist system is active but it is not available (the control lamp is lit up yellow)

- When driving at speeds below 65 km/h (38 mph).
- When the Lane Assist system does not detect the dividing lines of the road. For example, in the event warnings indicating road works, and snow, dirt, moisture or reflections.
- When the radius of a curve is too small.
- When no road markings can be seen.
- When the distance to the next marking is too great.
- When the system does not detect any clear and active steering movement during a long period of time.
- Temporarily, in the event of very dynamic driving styles.
- If a turn signal is activated.
- With the stability control system ESC in Sport mode.



Note

- Before starting a journey, verify that the field of vision of the camera is not covered ⇒ Fig. 99.
- Always keep the field of vision of the camera clean. ■

Switching off the Lane Assist system in the following situations

Due to the limits of the Lane Assist system, switch it off in the following situations:

- When more attention is required of the driver
- When driving in a sporty style
- In unfavourable weather conditions
- On roads in poor condition
- In areas of road works



Note

The Lane Assist system deactivates when driving below 60 km/h (40 mph). ■

SEAT Drive Modes*

Introduction

SEAT Drive Mode enables the driver to choose between four profiles or modes, **normal**, **sport**, **eco** and **individual**, that modify the behaviour of various vehicle functions, providing different driving experiences. ▶

The profiles, **normal**, **sport** and **eco** are fixed. **Individual** can be configured according to personal preferences.

Description

Depending on the equipment fitted in the vehicle, SEAT Drive Mode can operate on the following functions:

Engine

Depending on the profile selected, the engine responds more spontaneously or more in harmony with the movements of the accelerator. Additionally, when **eco** mode is selected, the Start-stop function is automatically activated.

In vehicles with DQ transmission, the gear change points are modified to position them in lower engine speed ranges (**eco**) or higher (**sport**). Additionally, **eco** mode activates the Inertia function, enabling the consumption to be further reduced.

In manual vehicles, **eco** mode causes the gear recommendation indications that appear on the instrument panel to vary, facilitating more efficient driving.

Steering

Power steering becomes more robust in **sport** mode to enable a more sporty driving style.

Air conditioning

In vehicles with Climatronic, this can operate in **eco** mode, especially restricting fuel consumption.

Ambient lighting

The ambient lighting guides located in the interior front door panels of the Leon FR change colour from white to red when **sport** mode is activated.

Setting driving mode

You can select from Normal, Sport, Eco and Individual.



Fig. 100 Centre console: **MODE** button

The required mode can be selected on the touch screen, in the menu that opens when the **MODE** button is pressed.

An icon on the Easy Connect system display informs about the active mode.

The **MODE** button light remains lit up yellow when the active mode is different to **normal**.

Driving profile	Characteristics
Normal	Offers a balanced driving experience, suitable for everyday use.
Sport	Provides a complete dynamic performance in the vehicle, enabling the user a more sporty driving style.

Driving profile	Characteristics
Eco	Places the vehicle in a particularly low state of consumption, facilitating a fuel-saving driving style that is respectful to the environment.
Individual	Enables some configurations to be modified by pressing the Profile settings button. The functions that can be adjusted depend on the equipment fitted in the vehicle.

 **WARNING**

When operating SEAT Drive Mode, pay attention to all traffic. Doing otherwise could cause an accident.

 **Note**

- The vehicle will start in the mode that was selected at the moment it was switched off.
- Changing modes can alter vehicle handling. The SEAT Drive Mode function does not allow configurations that compromise safety under any circumstances.
- Your speed and driving style must always be adjusted to visibility, weather, and traffic conditions.
- The **eco** mode is not available when towing a trailer.

Tiredness detection (break recommendation)*

Introduction

The Tiredness detection informs the driver when their driving behaviour shows signs of fatigue.

Additional information and warnings:

- Easy Connect system ⇒ page 79
- Accessories, change a part, repairs and adjustments (information stored in the control units) ⇒ page 230

 **WARNING**

Do not let the comfort afforded by the Tiredness detection system tempt you into taking any risks when driving. Take regular breaks, sufficient in length when making long journeys.

- The driver always assumes the responsibility of driving to their full capacity.
- Never drive if you are tired.
- The system does not detect the tiredness of the driver in all circumstances. Consult the information in the section ⇒ page 174, System limitations.
- In some situations the system may incorrectly interpret an intended driving manoeuvre as driver tiredness.
- No warning is given in the event of the effect called microsleep!
- Please observe the indications on the instrument panel and act as is necessary.



Note

- Tiredness detection has been developed for driving on motorways and well paved roads only.
- If there is a fault in the system, have it checked by a specialised workshop.

Function and operation

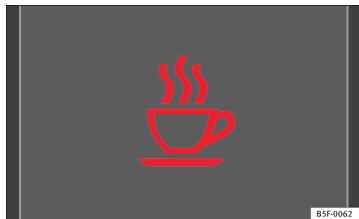

Fig. 101 On the instrument panel display: Tiredness detection symbol

Tiredness detection determines the driving behaviour of the driver when starting a journey, making a calculation of tiredness. This is constantly compared with the current driving behaviour. If the system detects that the driver is tired, an audible warning is given with a sound and an optic warning is shown with a symbol and complementary message on the instrument panel display ⇒ Fig. 101. The message on the instrument panel display is shown for about 5 seconds, and depending on the case, is repeated. The system stores the last message displayed.

The message on the instrument panel display can be switched off by pressing the **(OK/PRESET)** button on the windscreen wiper lever or the button **(OK)** on the multi function steering wheel ⇒ page 73.

The message can be recalled to the instrument panel display using the multifunction display ⇒ page 73.

Conditions of operation

Driving behaviour is only calculated on speeds above about 65 km/h (40 mph) up to around 200 km/h (125 mph).

Switching on and off

Tiredness detection can be activated or deactivated in the Easy Connect system with the button **(CAR)** and the function button **(Setup)** ⇒ page 79. A mark indicates that the adjustment has been activated.

System limitations

The Tiredness detection has certain limitations inherent to the system. The following conditions can limit the Tiredness detection or prevent it from functioning.

- At speeds below 65 km/h (40 mph)
- At speeds above 200 km/h (125 mph)
- When cornering
- On roads in poor condition
- In unfavourable weather conditions
- When a sporty driving style is employed
- In the event of a serious distraction to the driver

Tiredness detection will be restored when the vehicle is stopped for more than 15 minutes, when the ignition is switched off or when the driver has unbuckled their seat belt and opened the door.

In the event of slow driving during a long period of time (below 65 km/h (40 mph) the system automatically re-establishes the tiredness calculation. When driving at a faster speed the driving behaviour will be recalculated. ■

Tyre monitoring systems

Introduction

Additional information and warnings:

- SEAT information system ⇒ page 73
- Caring for and cleaning the vehicle exterior ⇒ page 198
- Wheels and tyres ⇒ page 223
- Accessories, parts replacement, repairs and modifications ⇒ page 230

WARNING

Unsuitable handling of the wheels and tyres may lead to sudden tyre pressure losses, to tread separation or even to a blow-out.

- Check tyre pressures regularly and ensure they are maintained at the pressures indicated. Tyre pressure that is too low could cause overheating, resulting in tread detachment or even burst tyres.
- Tyre pressure should be that indicated on the label when the tyres are cold at all times ⇒ page 266.
- Regularly check the cold inflation pressure of the tyres. If necessary, change the tyre pressure of the vehicle tyres while they are cold.
- Regularly check your tyres for damage and wear.
- Never exceed the maximum permitted speed or loads specified for the type of tyre fitted on your vehicle.



For the sake of the environment



Under-inflated tyres lead to increased fuel consumption and tyre wear.



Note

- Driving for the first time with new tyres at a high speed can cause them to slightly expand, which could then produce an air pressure warning.
- Only replace used tyres with those authorised by SEAT for the corresponding type vehicle.
- Do not only rely on the tyre monitoring system. Regularly check your tyres to ensure that the tyre pressure is correct and that the tyres are not damaged due to puncture, cuts, tears and impacts/dents. Remove objects from the tyres only when they have not pierced the tyres.

Tyre monitor indicator warning lamp

lights up	Possible cause	Solution
	The pressure in one or more tyres has clearly reduced in comparison to the tyre pressure set by the driver or the tyre has structural damage. Additionally, an audible warning can be heard and a text message can be seen on the instrument panel display.	 Stop the vehicle! Reduce speed immediately! Stop the vehicle safely as soon as possible. Avoid sudden manoeuvres and braking! Check all tyres and pressures. Replace any damaged tyres.
flashes	Possible cause	Solution
	System malfunction. The control lamp flashes for about one minute and then lights up permanently.	If the tyre pressure is correct, switch the ignition off and on again. If the control lamp remains lit up, the tyre monitoring indicator can be calibrated. Have the system reviewed by a specialised workshop.

Several warning and control lamps light up for a few seconds when the ignition is switched on while the function is verified. They will switch off after a few seconds.

WARNING

When the tyres are inflated at different pressures or at a pressure that is too low then a tyre may be damaged resulting in a loss of control of the vehicle and a serious or fatal accident.

- If the warning lamp  lights up, stop immediately and check the tyres.
- If the tyres are inflated at different pressures or if a tyre pressure is too low, this will increase tyre wear, negatively affecting vehicle stability and increasing braking distances.
- If tyres are inflated at different pressures or a tyre pressure is too low, a tyre may be damaged and burst resulting in a loss of control of the vehicle.
- The driver is responsible for ensuring that all of the vehicle tyres are correctly inflated to the right pressure. The recommended tyre pressure is indicated on the label ⇒ page 266.
- The tyre monitoring system can only operate correctly if all of the tyres are inflated to the correct pressure when cold.
- Driving with tyres at the wrong pressure can cause them damage and result in an accident. Ensure that the tyre pressures of all the tyres correspond to the vehicle load.
- Before starting a journey, always inflate tyres to the correct pressure.
- Tyres with insufficient pressure are subjected to more flexing. Due to this, the tyre could become excessively hot, causing tread separation and also tyre blow-out.
- With an overloaded vehicle at high speed, the tyres can overheat and burst resulting in a loss of vehicle control.

WARNING (Continued)

- Tyre pressures which are too high or too low reduce the useful life of the tyre, affecting vehicle performance.
- If a tyre has not been punctured then it does not have to be changed immediately; drive to the nearest specialised workshop at a moderate speed and have the tyre checked and inflated to the correct pressure.

WARNING

If the warning lamps and messages are ignored, the vehicle may stall in traffic, or may cause accidents and severe injuries.

- Never ignore the warning lamps or text messages.
- Stop the vehicle safely as soon as possible.

CAUTION

Failure to heed the control lamps and text messages when they appear may result in faults in the vehicle.

Note

- If excessively low tyre pressure is detected with the ignition on, an audible warning will sound. In the event that there is a fault in the system, an audible warning will sound.
- Driving on dirt tracks for a long period of time or driving in a sporty style can temporarily deactivate the TPMS. The control lamp shows a fault, but disappears when road conditions or the driving style change. ■

Tyre monitoring indicator



Fig. 102 Glove compartment: tyre control switch

The tyre monitor indicator compares wheel revolutions and, with this information, the tread of each wheel using the ABS sensors. If the tread of one or more wheels is changed, the tyre monitoring indicator will indicate as such on the instrument panel.

Wheel tread change

The wheel tread changes when:

- Tyre pressure is manually changed
- Tyre pressure is insufficient
- Tyre structure is damaged
- The vehicle is unbalanced because of a load
- The wheels on an axle are subject to a heavier load (e.g. when towing a heavy load)
- The vehicle is fitted with snow chains
- The temporary spare wheel is fitted
- The wheel on one axle is changed

There may be a delay in the reaction of the tyre monitoring indicator (⚠) or it may not indicate anything under certain circumstances (e.g. sporty driving, snow-covered or unpaved roads, or when driving with snow chains).

Calibrating the tyre monitoring indicator

After changing the tyre pressure or replacing one or more wheels, the tyre monitoring indicator must be recalibrated. Do the same, for example, when the front and rear wheels are swapped.

- Switch the ignition on.
- Store the new tyre pressure in the Easy Connect system with the button (CAR) and the function button (Setup) ⇒ page 80 or using the switch located in the glove compartment* ⇒ Fig. 102.

When driving, the system self-calibrates the tyre pressure provided by the driver and the wheels fitted. After a long journey with varied speeds the programmed values are collected and monitored.

With the wheels under very heavy loads, the tyre pressure must be increased to the total recommended tyre pressure before the calibration ⇒ page 266.



Note

- The tyre monitoring indicator does not function when there is a fault in the ESC or ABS ⇒ page 183.
- An erroneous indication may be given when snow chains are in use because the chains increase the tread of the wheel. ■

Parking aid

General information

Various systems are available to help you when parking or manoeuvring in tight spaces, depending on the equipment fitted on your vehicle.

The **rear parking aid** is an audible assistant that warns about obstacles located *behind* the vehicle ⇒ page 179.

During parking, the **plus parking aid** assists you visually and audibly about obstacles detected *in front* and *behind* the vehicle ⇒ page 179.



WARNING

- **Always pay attention (also when looking straight ahead) to traffic and the vehicle surroundings. The assistance systems are not a replacement for driver awareness. When inserting or removing the vehicle from a parking space, or when performing similar manoeuvres the driver always assumes the responsibility.**
- **Take into account that the system is not always in conditions to recognise or represent certain surfaces, such as dress fabric: Risk of causing an accident!**
- **The sensors and cameras have blind spots, making the detection of people and objects impossible. Pay special attention to children and animals: Risk of causing an accident!**
- **Always keep visual control of the vehicle surroundings: use the rear vision mirrors for additional help.**



CAUTION

- Under certain circumstances, the system does not detect or display certain objects:
 - Objects such as snow chains, trailer draw bars, bars or fences
 - Objects that are located above the sensors, such as protrusions in a wall.
 - Objects with certain surfaces or structures, such as wire mesh fences or powder snow.
- When the vehicle approaches a low obstacle, it could disappear from the angle of measurement. In this case, take into account that the system will no longer warn about this obstacle.
- The knocks or damage on the radiator grille, bumper, wheel arch and vehicle underbody can adjust the orientation of the sensors. This can affect the parking aid function. Have the function checked by a specialised workshop.



Note

- In certain situations, the system can give a warning even though there is no obstacle in the detected area, e.g:
 - for roads with certain surfaces, or with long grass
 - for external ultrasound sources, such as cleaning vehicles
 - In downpours, intense snow or dense exhaust gases
- In order to familiarise yourself with the system, it is advised that you practice parking in an area or car park that is free from traffic. There must be good weather and light conditions.
- The volume and tone of the warnings can be modified, in addition to the indications ⇒ page 181.
- In vehicles *without* a driver information system, these parameters can be modified in a SEAT Official Service or in a specialised workshop.
- Please observe information on towing a trailer ⇒ page 182. ▶

- The display on the Easy Connect screen shows a slight time delay.
- To ensure that the parking aid works properly, the sensors must be kept clean and free of ice and snow.

Rear parking aid*

The rear parking aid is an audible assistant.

Description

There are sensors integrated in the rear bumper. When the sensors detect an obstacle, you are alerted by audible warnings.

Make sure that the sensors are not covered by adhesives, residues and the like, given that this could affect the system operation. Cleaning instructions → page 199.

The approximate measurement range of the sensors is:

rear	side	0.90 m
	centre	1.60 m

As you approach the obstacle, the time interval between the audible warnings will be reduced. When you reach around 0.30 m the warning will be constant: Do not continue to move forward (or backward) ⇒ ⚠ in General information on page 178, ⇒ Ⓞ in General information on page 178 !

If you maintain separation from the obstacle, the volume of the warning begins to reduce after four seconds (does not affect the tone of the constant warning).

Activate

When engaging reverse gear, the parking aid is automatically switched on. This is confirmed with a short warning.

Plus parking aid*

Plus parking aid assists you audibly and visually when parking.

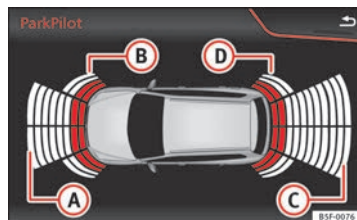

Fig. 103 Represented area

There are sensors integrated in the front and rear bumpers. When the sensors detect an obstacle, audible and visual warnings are given.

Make sure that the sensors are not covered by adhesives, residues and the like, given that this could affect the system operation. Cleaning instructions → page 199.

The approximate measurement range of the sensors is:

A	1.20 m
B	0.90 m
C	1.60 m
D	0.90 m

As you approach the obstacle, the time interval between the audible warnings will be reduced.

If you maintain separation from the obstacle, the volume of the warning begins to reduce after four seconds (does not affect the tone of the constant warning).

Activating/Deactivating



Fig. 104 Centre console: parking aid button

Switching on

- Engage reverse gear or
- Press the **P** button on the centre console ⇒ Fig. 104. A short confirmation signal will be heard and the button symbol will light up yellow.

Switching off

- Drive forwards at more than 10 km/h (6 mph), or
- Press the **P** button, or
- Switch the ignition off

Segments of the visual indication

The distance of separation from the obstacle can be estimated using the segments around the vehicle. With certain equipment (Radio Standard), the yellow lines* mark the estimated path, depending on the angle of the turned steering wheel. A white segment is seen when an obstacle is detected out of the path of the vehicle. The red segments represent obstacles detected within the path. As the vehicle approaches an obstacle, the segments are displayed closer to the vehicle. When the penultimate segment is displayed, this means that the vehicle has reached the collision zone. In the collision zone the obstacles are represented in red, including those out of the path. Do not continue to move forward (or backward) ⇒ ⚠ in General information on page 178, ⇒ Ⓜ in General information on page 178 !

Automatic activation¹⁾

When the parking aid (ParkPilot) is automatically switched on this is shown in miniature on the left side of the display.

When slowly approaching an obstacle located in front of the vehicle, the automatic activation only functions each time the speed is reduced below approximately 10 km/h (6 mph) for the first time. If the parking aid is deactivated using the **P** button, the following actions must be carried out in order for it to automatically reactivate:

- Switch off the ignition and switch it on again.
- ALTERNATIVELY: Accelerate above 10 km/h (6 mph) before reducing speed below this number again.
- ALTERNATIVELY: Place the selector lever in position P and then move it from this position.
- ALTERNATIVELY: Switch on and off the automatic activation in the Easy Connect system menu.

The automatic activation with parking aid miniature indication can be switched on and off from the Easy Connect system menu ⇒ page 81: ▶

¹⁾ Available only with certain equipment.

- Switch the ignition on.
- Press button **CAR**.
- Press the **Setup** function button.
- Press the **Parking and Manoeuvring** function button.
- Select the parking aid (ParkPilot) from the list.
- Automatic activation.

When the function button check box is activated ✓, the function is on.

Adjusting the display and audible warnings

The settings for the display and audible warnings are controlled via the Easy Connect.*

Requirements: the parking aid must be switched on.

- Select: button **CAR** > control button Car* **Systems** > **Driver assistant** > **Parking aid** ⇒ page 81.

Automatic activation¹⁾

- on** – activates the **Automatic activation** option ⇒ page 180
- off** – deactivates the **Automatic activation** option ⇒ page 180.

Front volume

Volume in the front and rear area.

Front sound settings

Frequency (tone) of the sound in the front area.

Rear volume

Volume in the rear area

Rear sound settings

Frequency (tone) of the sound in the rear area.

Adjust volume

With the parking aid switched on, the active audio/video source volume will be reduced to the intensity of the selected setting.

You will hear a short test tone from the corresponding speaker each time you make a new setting.

Error messages

When the parking aid is activated or when switching it on, if a continuous warning can be heard over several seconds (additionally, in the case of Plus parking aid the LED of the **P** button flashes), there is a fault in the system. If the fault does not disappear before switching off the ignition, the next time the parking aid is switched on by engaging reverse gear the fault will only be indicated with the flashing LED on the **P** button.

Plus parking aid*

If there is a fault in a sensor, the symbol  is displayed on the Easy Connect display in front of/behind the vehicle. If a rear sensor is faulty, only the obstacles in the areas **A** and **B** are displayed ⇒ Fig. 103. If a front sensor is faulty, only the obstacles in the areas **C** and **D** are displayed.

Have the fault corrected by a specialised workshop without delay.

¹⁾ available only with certain equipment - Radio Standard

Towing bracket

If the trailer power socket is occupied, the rear parking aid sensors will not activate when reverse gear is engaged, or when the button **P_{PA}** is pressed. This function may not be covered under warranty if the towing bracket is not factory-fitted. This causes the following limitations:

Plus parking aid*

There will be no warning about the presence of obstacles in the rear area. The monitoring in the front area remains active. The optical display changes to towing mode. ■

Practical Tips

Intelligent technology

Electronic Stability Control (ESC)

Description

El ESC helps to improve safety. It reduces the tendency to skid and improves the stability and roadholding of the vehicle. El ESC detects critical handling situations, such as vehicle understeer or oversteer, or wheelspin on the driving wheels. It stabilises the vehicle by braking individual wheels or by reducing the engine torque. The warning lamp will flash on the instrument panel when the ESC is intervening .

ESC includes the Anti-lock brake system (ABS), the brake assist system, the traction control system (ASR), electronic differential lock (EDL), electronic self-locking*, selective torque control* and tractor-trailer sway mitigation*. ESC also helps stabilise the vehicle by changing the torque.

Anti-lock brake system (ABS)

ABS prevents the wheels from locking up under braking until the vehicle has reached a virtual standstill. You can continue to steer the vehicle even when the brakes are on full. Keep your foot on the brake pedal and do not pump the brakes. You will feel the brake pedal pulsate while the ABS is working.

Brake assist system

The brake assist system can reduce the required braking distance. The braking force is automatically boosted if you press the brake pedal quickly in an emergency. You must keep pressing the brake pedal until the danger has passed.

Traction control system (ASR)

In the event of wheelspin, the traction control system reduces the engine torque to match the amount of grip available. This helps the car to start moving, accelerate or climb a gradient.

Electronic differential lock (EDL)

When the EDL detects wheelspin, it brakes the spinning wheel and directs the power to the other driven wheel. This function is available up to a speed of around 100 km/h, 62 mph).

To prevent the disc brake of the braked wheel from overheating, the EDL cuts out automatically if subjected to excessive loads. The vehicle can still be driven. The EDL will switch on again automatically when the brake has cooled down.

Tractor-trailer sway mitigation*

If the vehicle is pulling a trailer, it will control the following: Tractor-trailers tend to sway. When the swaying of the trailer is felt by the vehicle and detected by the ESC, it will automatically brake the towing vehicle within the limits of the system and mitigate the sway. Tractor-trailer sway mitigation is not available in all countries.

Electronic self-locking*/Selective torque control*

When driving around bends, an electronic self-locking intervenes. The front wheel on the inside of the curve, or the two inside wheels, respectively, are selectively braked as required. This minimises the traction of the front wheels, allowing you to take bends with greater precision and neutrality. In certain circumstances, where roads are wet or snow-covered, the respective system may not intervene. ▶

Multi-collision brake

In an accident, the multi-collision brake can help the driver by braking to avoid the risk of skidding during the accident, which could lead to further collisions.

The multi-collision brake works for front, side or rear accidents, when the airbag control unit records its activation level and the accident takes place at a speed of over 10 km/h (6 mph). The EI ESC automatically brakes the vehicle, as long as the accident has not damaged the ESC, the brake hydraulics or the on-board network.

The following actions control automatic braking during the accident:

- When the driver presses the accelerator. The automatic braking does not take place.
- When the braking pressure through pressing the brake pedal is greater than the system's braking pressure. The vehicle will brake manually.
- Multi-collision braking will not be available if ESC is malfunctioning.





WARNING

- **Nor can the ESC, ABS, ASR, EDL, electronic self-locking differential or selective torque control systems exceed the limits imposed by the laws of physics. Always bear this in mind, especially on wet or slippery roads. If you notice the systems cutting in, you should reduce your speed immediately to suit the road and traffic conditions. Do not be encouraged to take risks by the presence of more safety systems. If you do, an accident may occur.**
- **Please remember that the accident risk always increases if you drive fast, especially in corners or on a slippery road, or if you follow too close behind the vehicle in front of you. The ESC, ABS, brake assist, EDL, electronic self-locking and selective torque control systems cannot prevent accidents: risk of accidents!**
- **Accelerate with caution on slippery surfaces (for example, icy or snow-covered). Despite the control systems, the driven wheels could spin, affecting the stability of the vehicle: risk of accident!**



Note

- The ABS and ASR will only operate correctly if the four wheels have identical tyres. Any differences in the rolling radius of the tyres can cause the system to reduce engine power when this is not desired.
- The regulating processes of the systems can make noises when they intervene.
- If the warning lamp  lights up, or  alternatively, there could be a fault ⇒ page 69.

Switching on/off the ESC and ASR

The ESC is switched on automatically when the engine is started. The ESC cannot be deactivated.

ESC in "Sport" mode

Sport mode is activated through the Easy Connect system ⇒ page 79 menu. The ability of the ESC to stabilise the vehicle is limited; the traction control system (ASR) becomes disabled ⇒ .

The control lamp  will light up. For vehicles with a driver information system*, the driver will be shown the **electronic stability control (ESC) option: sport. Warning! Limited stability.**

In the following exceptional circumstances enabling the ESC Sport mode to improve the traction of the wheels is tenable:

- when rocking the vehicle backwards and forwards to free it.
- Driving in deep snow or on loose surfaces.

Disable ESC Sport mode

Through the Easy Connect system ⇒ page 79. The warning lamp  will switch off. For vehicles with a driver information system*, the driver will be shown the **electronic stability control (ESC) option: on.**

Disable ASR

ASR can be disabled through the Easy Connect system ⇒ page 79 or by pressing the  button. The traction control system will be disabled.

The control lamp  will light up. For vehicles with a driver information system* the driver will be informed that **ASR is disabled**.

In the following exceptional circumstances enabling the ESC Sport mode to improve the traction of the wheels is tenable:

- when rocking the vehicle backwards and forwards to free it.
- Driving in deep snow or on loose surfaces.

Activate ASR

ASR can be switched on through the Easy Connect system ⇒ page 79 or by pressing the  button. The traction control system will be enabled.

The control lamp  switches off. For vehicles with a driver information system* the driver will be informed that **ASR is enabled**.



WARNING

You should switch on the ESC Sport mode only if the traffic conditions and your driving ability allow you to do so safely: risk of skidding!

- **With ESC in Sport mode, the stabilising function will be limited to allow for a sportier drive. The driving wheels could spin and the vehicle could skid.**



Note

- ESC Sport mode cannot be activated if the cruise control* actively intervenes. ■

Brakes

New brake pads

For the first 400 km (250 miles), new brake pads have not yet reached their maximum braking capacity, and need to be "run in" first. However, you can compensate for the slightly reduced braking effect by applying more pressure on the brake pedal. Avoid overloading the brakes while running them in.

Wear

The rate of wear on the **brake pads** depends a great deal on how you drive and the conditions in which the vehicle is operated. This is a particular problem in urban traffic and short stretches, or with very sporty driving.

Depending on the speed, the braking force, and the environmental conditions (for example, the temperature, air humidity, etc.) noises may be produced on braking.

Wet roads or road salt

In certain situations (for example, on driving through flooded areas, in severe downpours or after washing the vehicle) the braking action could be delayed if the discs and pads are damp, or frozen in winter. In this case the brakes should be dried by pressing the brake pedal several times.

At high speed and with the windscreen wipers activated, the brake pads will briefly touch the brake discs. This takes place, although unnoticeable to the driver, at regular intervals to improve the response time of the brakes when they are wet.

The effectiveness of the brakes can also be temporarily reduced if the vehicle is driven for some distance without using the brakes when there is a lot of salt on the road in winter. The layer of salt that accumulates on the discs and pads can be removed by gently applying the brakes a few times. ►

Corrosion

There may be a tendency for corrosion to form on the discs and dirt to build up on the brake pads if the vehicle is used infrequently or the brakes are not used very often.

If the brakes are not used frequently, or if rust has formed on the disks, it is advisable to clean off the pads and disks by braking firmly a few times at a moderately high speed ⇒ ⚠.

Fault in the brake system

If the brake pedal travel should ever increase *suddenly*, this may mean that one of the two brake circuits has failed. Drive immediately to the nearest specialised workshop and have the fault repaired. Drive there slowly and remember that you will have to apply more pressure on the brake pedal and allow for longer stopping distances.

Low brake fluid level

Malfunctions can occur in the brake system if the brake fluid level is too low. The brake fluid level is monitored electronically.

Brake servo

The brake servo increases the pressure you apply to the brake pedal. It works only when the engine is running.



WARNING

- **Apply the brakes heavily to clean the brake system only in a suitable traffic situation. Do not put other road users in danger: risk of causing an accident.**
- **Ensure the vehicle does not move while in neutral, when the engine is stopped. Failure to do so could result in an accident.**



CAUTION

- Never let the brakes “drag” by leaving your foot on the pedal when it is not necessary to brake. This overheats the brakes, resulting in longer stopping distances and greater wear.
- Before driving down a long, steep gradient, it is advisable to reduce speed and select a lower gear. This makes use of engine braking and relieves the brakes. If you still have to use the brakes, it is better to brake firmly at intervals than to apply the brakes continuously.



Note

- If the brake servo is out of action due to a malfunction, or if the car has to be towed, you will have to press the brake pedal considerably harder to make up for the lack of servo assistance.
- If you wish to equip the vehicle with accessories such as a front spoiler or wheel covers, it is important that the flow of air to the front wheels is not obstructed, otherwise the brakes can overheat. ■

Electro-mechanical steering

Electro-mechanical power steering assists the driver when steering.

Electro-mechanical power steering adapts *electronically* to the speed of the car, torque and turning angle.

If the power steering should fail at any time or the engine is switched off (for instance when being towed), the car can still be steered. However, more effort than normal will be required to turn the steering wheel.

Driver warning lamps and messages

⚠ (in red) Faulty steering! To park the vehicle ▶

If the warning lamp remains on and the driver indication appears, the power steering could be faulty.

Do **not** continue driving. Seek specialist assistance.

 (in yellow) **Steering: System fault! You may continue driving.**

If the warning lamp comes on, the steering could react with more difficulty or more sensitivity than normal. In addition, when driving in a straight line the steering wheel may be off-centre.

Drive slowly to a specialised workshop and have the fault repaired.

 (in yellow) **Steering lock: fault! Go to an Official Service**

The electronic steering lock is malfunctioning.

Go to a specialised workshop as soon as possible and have the fault repaired.





WARNING

Take it immediately to a specialised workshop and have the fault repaired: risk of accident!



Note

If a  red or  yellow warning lamp come on briefly, you can continue driving.

Power Management

This system helps to ensure reliable starting

The power management controls the distribution of electrical energy and thus helps to ensure that there is always enough power available to start the engine.

If a vehicle with a conventional electrical system is left parked for a long time, the battery will gradually lose its charge because certain electrical equipment (such as the electronic gearbox lock) continues to draw current even when the ignition is off. In some cases there may not be enough power available to start the engine.

Your vehicle is equipped with an intelligent power management system to control the distribution of electrical energy. This significantly improves reliability when starting the engine, and also prolongs the useful life of the battery.

The main functions incorporated in the power management system are **battery diagnosis**, **residual current management** and **dynamic power management**.

Battery diagnosis

The battery diagnosis function constantly registers the condition of the battery. Sensors detect the battery voltage, battery current and battery temperature. This enables the system to calculate the current power level and charge condition of the battery.

Residual current management

The residual current management reduces power consumption while the vehicle is parked. It controls the supply of power to the various electrical components while the ignition is switched off. The system takes the battery diagnosis data into consideration. ▶

Depending on the power level of the battery, the individual electrical components are switched off one after the other to prevent the battery from losing too much charge and to ensure that the engine can be started reliably.

Dynamic power management

While the vehicle is moving, this function distributes the available power to the various electrical components and systems according to their requirements. The power management ensures that on-board systems do not consume more electrical power than the alternator can supply, and thus maintains the maximum possible battery power level.



Note

- The power management system is not able to overcome the given physical limits. Please remember that the power and useful life of the battery are limited.
- When there is a risk that the vehicle will not start, the alternator power failure or low battery charge level warning lamp will be shown → page 69.

Note carefully

Starting ability has first priority.

Short trips, city traffic and low temperatures all place a heavy load on the battery. In these conditions a large amount of power is consumed, but only a small amount is supplied. The situation is also critical if electrical equipment is in use when the engine is not running. In this case power is consumed when none is being generated.

In these situations you will be aware that the power management system is intervening to control the distribution of electrical power.

When the vehicle is parked for long periods

If you do not drive your vehicle for a period of several days or weeks, the power management will gradually shut off the on-board systems one by one, or reduce the amount of current they are using. This limits the amount of power consumed and helps to ensure reliable starting even after a long period. Some convenience functions, such as remote vehicle opening, may not be available under certain circumstances. These functions will be restored when you switch on the ignition and start the engine.

With the engine switched off

For example, if you listen to the sound system with the engine switched off the battery will run down.

If the energy consumption means there is a risk that the engine will not start, a text will appear in vehicles with a driver information system*.

This driver indicator tells you that you must start the engine so that the battery can recharge.

When the engine is running

Although the alternator generates electrical power, the battery can still become discharged while the vehicle is being driven. This can occur when a lot of power is being consumed but only a small amount supplied, especially if the battery is not fully charged initially.

To restore the necessary energy balance, the system will then temporarily shut off the electrical components that are using a lot of power, or reduce the current they are consuming. Heating systems in particular use a large amount of electrical power. If you notice, for instance, that the seat heating* or the heated rear window is not working, they may have been temporarily switched off or regulated to a lower heat output. These systems will be available again as soon as sufficient electrical power is available.

You may also notice that the engine runs at a slightly faster idling speed. This is quite normal, and no cause for concern. The increased idling speed allows the alternator to meet the greater power requirement and charge the battery at the same time.

Information recorded in the control units

Your vehicle is fitted at the factory with a series of electronic control units responsible for the engine and gearbox management. In addition, the control units supervise the correct performance of the exhaust gas system and the airbag systems.

Therefore, while the vehicle is being driven, these electronic control units are continuously analysing the vehicle data. In the event of faults or deviations from the theoretical values, only this data is stored. Generally, the instrument panel warning lamps indicate whether there are any malfunctions.

This data can only be read and analysed using special equipment.

The storing of the data allows specialised workshops to detect and repair faults. Stored data may include:

- Important data about the engine and gearbox
- Speed
- Direction of travel
- Braking force
- Seat belt check

The vehicle control units never record conversations held by passengers in the vehicle.

If the control unit records an accident with airbag activation, the system may automatically send a signal. This will depend on the network operator. Normally, transmission is only possible in areas with sufficient coverage.

Event Data Recorder

The vehicle is **not** fitted with an event data recorder.

An event data recorder temporarily stores the vehicle information. Therefore, in the event of accident, it is possible to obtain detailed information about how the accident occurred. For example, in vehicles with airbag systems, data relating to speed of impact, seat belt status, seat positions and

airbag activation times may be stored. The volume of data depends on the manufacturer.

Event data recorders can only be mounted with authorisation from the vehicle owner and, in some countries, they are governed by local legislation.

Reprogramming control units

On the whole, all the data required for the component management is stored in the control units. The programming of certain convenience functions, such as the turn signal convenience mode, individual door opening and display indications can be modified using special equipment at the workshop. If the convenience functions are reprogrammed, the Instruction Manual information and descriptions will not coincide with the modified functions. Therefore, SEAT recommends that any changes are recorded in the "Other workshop notes section" of the Service Plan.

You can find out about possible reprogramming at your SEAT Official Service.

Event recorder

In the footwell on the driver side you will find the diagnostics connection socket for reading the event recorder. The event recorder stores operating data and data on the status of the electronic control units. The events recorder should only be read and deleted by a SEAT Official Service or specialised workshop.



WARNING

The diagnostics connection socket must not be used for private purposes. Improper use can cause malfunctions: risk of accident!

Driving and the environment

Running in the engine

A new vehicle should be run in over a distance of 1500 km (1000 miles). For the first 1000 km (600 miles) the engine speed should not exceed 2/3 of the maximum permissible engine speed. In doing so, do not accelerate at full throttle and do not drive with a trailer! From 1000 to 1500 km (600 to 1000 miles) you can gradually increase the engine rpm and road speed.

During its first few hours of running, the internal friction in the engine is greater than later on when all the moving parts have bedded down.

How the vehicle is driven for the first 1500 km (1000 miles) influences the future engine performance. Subsequently, also drive at a moderate rate, especially when the engine is still cold: this will lead to less engine wear and tear and will prolong its useful life.

You should also avoid driving with the engine speed too low. Change down to a lower gear when the engine no longer runs "smoothly". If the engine revs too much, cut fuel injection to protect the engine. ■

Driving through flooded roads

To prevent damage to the vehicle when driving through water, for example, along a flooded road, please observe the following:

- The water should never come above the lower edge of the bodywork.
- Drive at pedestrian speed.



WARNING

After driving through water, mud, sludge, etc., the braking effect can be delayed slightly due to moisture build-up on the discs and brake pads. Applying the brakes carefully several times will remove the moisture and restore the full braking effect.



CAUTION

- Driving through flooded areas may severely damage vehicle components such as the engine, transmission, running gear or electrical system.
- Whenever driving through water, the Start-Stop system* must be switched off ⇒ page 149.



Note

- Check the depth of the water before entering the flooded zone.
- Do not stop in the water, drive in reverse, or stop the engine in any situation.
- Note that vehicles travelling in the opposite direction may splash water that could exceed the maximum permitted water height for your vehicle.
- Avoid driving through salt water (corrosion). ■

Installation of exhaust gas filtration systems

Catalytic converter

Applies to vehicles with petrol engine: The vehicle must only be used with unleaded petrol, otherwise the catalytic converter will be irreparably damaged. ▶

Never drive until the tank is empty; an irregular supply of fuel can cause faulty combustion. In these cases, unburned fuel reaches the exhaust system, which can overheat and damage the catalytic converter.

Diesel particulate filter

Applies to vehicles with diesel engine: The diesel particulate filter can filter out almost all soot particles contained in the exhaust gas. In normal driving conditions the filter is self-cleaning. The Diesel particulate filter is cleaned automatically without need for indication by the warning lamp . This may be noticed because the engine idle speed increases and an odour may be detected.

If automatic filter purification cannot be carried out (because only short trips are taken, for example), soot will accumulate on the filter and the Diesel particulate filter warning lamp will  switch on.

Facilitate the automatic filter cleaning process by driving in the following manner: Drive for approximately 15 minutes at a minimum speed of 60 km/h (40 mph) in 4th or 5th gear (automatic gearbox: gear S). Maintain the engine speed at approx. 2000 rpm. The rise in temperature causes the soot on the filter to burn. On completion of the cleaning the warning lamp will switch off. If the warning lamp does switch off, go immediately to a specialised workshop to rectify the problem.

WARNING

- Because of the high temperatures which can occur in the exhaust gas control system (catalytic converter or diesel particulate filter), do not park the vehicle where the exhaust can come into contact with flammable materials under the car (e.g. on grass or at the forest edge). Fire hazard!
- Do not apply wax underneath the vehicle around the area of the exhaust system: Fire hazard!

Economic and ecological driving

Fuel consumption, environmental pollution and wear to the engine, brakes and tyres depends largely on driving style. Fuel consumption can be reduced by 10-15% with an economical driving style and proper anticipation of traffic conditions. The following section gives you some tips on lessening the impact on the environment and reducing your operating costs at the same time.

Foresight when driving

Acceleration causes the vehicle to consume more fuel. If you think ahead when driving, you will need to brake less and thus accelerate less. Wherever possible, let the car roll slowly to a stop, with a **gear engaged** (for instance when you can see that the next traffic lights are red). This takes advantage of the engine braking effect, reducing wear on the brakes and tyres. Emissions and fuel consumption will drop to zero due to the overrun fuel cut-off.

Changing gear to save energy

An effective way of saving is to change *in advance* to a higher gear. Running the engine at high rpm in the lower gears uses an unnecessary amount of fuel.

Manual gearbox: shift up from first to second gear as soon as possible. In any case, we recommend that you change to a higher gear upon reaching 2000 rpm or so. Choosing the right gear enables fuel savings. Select the highest possible gear appropriate for the driving situation (the engine should continue functioning with cyclical regularity).

Automatic gearbox: accelerate gradually and without reaching the “kick-down” position.

Avoid driving at high speed

Avoid travelling at top speed, whenever possible. Fuel consumption, emission of harmful gases and noise pollution multiply disproportionately as speed is increased. Driving at moderate speeds will help to save fuel. ▶

Reduce idling time

In vehicles with the Start-Stop system idling is automatically reduced. In vehicles without the Start-Stop system it is worth switching off the engine, for example, at level crossings and at traffic lights that remain red for long periods of time. When an engine has reached operating temperature, and depending on the cylinder capacity, keeping it off after about 5 seconds already saves more than the amount of fuel necessary for restarting.

The engine takes a long time to warm up when it is idling. Mechanical wear and pollutant emissions are also especially high during this initial warm-up phase. It is therefore best to drive off immediately after starting the engine. Avoid running the engine at high speed.

Regular maintenance

Regular servicing helps in saving fuel even before the engine is started. A well-serviced engine gives you the benefit of **improved fuel efficiency** as well as maximum reliability and an enhanced resale value. A badly serviced engine can consume up to 10% more fuel than necessary.

Avoid short journeys

The engine and catalytic converter need to reach their optimal **operating temperature** in order to minimise fuel consumption and emissions.

A cold engine consumes a disproportionate amount of fuel. The engine only reaches its working temperature after about *four* kilometres (2.5 miles), when fuel consumption will return to a normal level.

Check tyre pressure

Always make sure the tyres are inflated to the correct pressures → page 223 to save fuel. If the pressure is below half bar, fuel consumption may increase by 5%. Due to the greater rolling resistance, under-inflation **also** increases tyre wear and impairs handling.

Do not use **winter tyres** all year round as they increase fuel consumption by up to 10%.

Avoid carrying unnecessary loads

Given that every kilo of **extra weight** will increase the fuel consumption, it is advisable to always check the luggage compartment to make sure that no unnecessary loads are being transported.

Since the luggage rack increases the **aerodynamic drag** of the vehicle, you should remove it when not needed. This will save, at a speed of 100-120 km/h (60-75 mph), approximately 12% of fuel.

Save electrical energy

The engine drives the alternator, thereby generating electricity. This implies that any increase in power consumption also increases fuel consumption! For this reason, switch off any unneeded consumption of electricity. Electrical equipment which uses a lot of electricity includes the blower (at a high setting), the rear window heating and the seat heating*.

Environmental friendliness

Environmental protection is a top priority in the design, choice of materials and production of your new SEAT.

Design measures for economical recycling

- Joints and connections designed for easy dismantling
- Modular construction to facilitate dismantling
- Increased use of single-grade materials
- Plastic parts and elastomers are rated in accordance with ISO 1043, ISO 11469 and ISO 1629

Choice of materials

- Nearly all materials used can be recycled
- Use of suitable plastics within the same system/set
- Recycled materials used in manufacture

- Reduced "vapour emissions" from plastics
- CFC-free refrigerant in air conditioner

Compliance with the laws prohibiting the use of: Cadmium, asbestos, lead, mercury, chromate.

Manufacturing methods

- Recyclable material for the manufacturing of plastic components
- Solvent-free cavity sealing
- Solvent-free wax for protecting the vehicles in transit
- Solvent-free adhesives
- No CFCs used in production
- Surplus materials used extensively for energy conversion and building materials
- Overall water consumption reduced
- Heat recovery systems
- Use of water-soluble paints

Trailer

Trailer towing

What do you need to bear in mind when towing a trailer?

Your vehicle may be used to tow a trailer when fitted with the correct equipment.

If you wish to **retrofit** a towing bracket, consult ⇒ page 196.

Connectors

Your vehicle is fitted with a 12-pin connector for the electrical connection between the trailer and the vehicle.

If the trailer has a **7-pin plug** you will need to use an adapter cable. This is available in any Technical Service.

Trailer weight/drawbar load

Never exceed the authorised trailer weight. If you do not load the trailer up to the maximum permitted trailer weight, you can then climb correspondingly steeper slopes.

The maximum trailer weights listed are only applicable for **altitudes** up to 1000 m above sea level. With increasing altitude the engine power and therefore the vehicle climbing ability are impaired because of the reduced air density. The maximum trailer weight has to be reduced accordingly. The weight of the vehicle and trailer combination must be reduced by 10% for every further 1000 m (or part thereof). The gross combination weight is the actual weight of the laden vehicle plus the actual weight of the laden trailer. When possible, operate the trailer with the maximum permitted **drawbar load** on the ball joint of the towing bracket, but do not exceed the specified limit.

The figures for **trailer weights** and **drawbar loads** that are given on the data plate of the towing bracket are for certification purposes only. The correct figures for your specific model, which may be *lower* than these figures for the towing bracket, are given in the vehicle documentation or in ⇒ chapter Technical Data.

Distributing the load

Distribute loads in the trailer so that heavy objects are as near to the axle as possible. Loads carried in the trailer must be secured to prevent them moving.

Tyre pressure

Set tyre pressure to the maximum permissible pressure shown on the sticker on the inside of the fuel tank flap. Set the tyre pressure of the trailer tyres in accordance with the trailer manufacturer's recommendations.

Exterior mirrors

Check whether you can see enough of the road behind the trailer with the standard rear vision mirrors. If this is not the case, you should have additional exterior mirrors fitted. Both exterior mirrors should be mounted on hinged extension brackets. Adjust the mirrors to give sufficient vision to the rear.



WARNING

Never transport people in a trailer. This could result in fatal accidents.

**Note**

- Towing a trailer places additional demands on the vehicle. We recommend additional services between the normal inspection intervals if the vehicle is used frequently for towing a trailer.
- Find out whether special regulations apply to towing a trailer in your country.

Ball coupling of towing bracket*

The ball coupling is provided with instructions on fitting and removing the ball coupling of the towing bracket.

**WARNING**

The towing bracket ball coupling must be stored securely in the luggage compartment to prevent them being flung through the vehicle and causing injury.

**Note**

- By law, the ball coupling must be removed if a trailer is not being towed if it obscures the number plate.

Driving tips

Driving with a trailer always requires extra care.

Weight distribution

The weight distribution of a loaded trailer with an unladen vehicle is very unfavourable. However, if this cannot be avoided, drive extra slowly to allow for the unbalanced weight distribution.

Speed

The stability of the vehicle and trailer is reduced with increasing speed. For this reason, it is advisable not to drive at the maximum permissible speed in an unfavourable road, weather or wind conditions. This applies especially when driving downhill.

- You should always reduce speed immediately if the trailer shows the slightest sign of **snaking**. Never try to stop the “snaking” by increasing speed.

Always brake in due course. If the trailer has an **overrun brake**, apply the brakes *gently at first* and then, firmly. This will prevent the jerking that can be caused by locking of trailer wheels. Select a low gear in due course before going down a steep downhill. This enables you to use the engine braking to slow down the vehicle.

Reheating

At very high temperatures and during prolonged slopes, driving in a low gear and high engine speed, always monitor the coolant temperature gauge → page 69.

Electronic Stability Control*

The ESC* system helps to stabilise the trailer in case of skidding or rocking. ■

Retrofitting a towing bracket*

It is possible to fit a towing bracket to the rear of the vehicle.

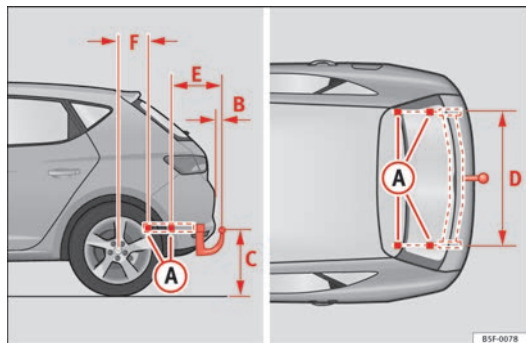

Fig. 105 Attachment points for towing bracket

If a towing bracket is to be fitted after the vehicle is purchased, this must be completed according to the instructions of the towing bracket manufacturer.

The attachment points for the towing bracket (A) are on the lower part of the vehicle.

The distance between the centre of the ball coupling and the ground should never be lower than the indicated value, even with a fully loaded vehicle and including the maximum drawbar load.

Elevation values for securing the towing bracket:

- (B) 65 mm (minimum)
- (C) from 350 mm to 420 mm (fully loaded vehicle)

- (D) 1040 mm
- (E) 317 mm
- (F) 339 mm

Fitting a towing bracket

- Driving with a trailer involves an extra effort for the vehicle. Therefore, before fitting a towing bracket, please contact a Technical Service to check whether your cooling system needs modification.
- The legal requirements in your country must be observed (e.g. the fitting of a separate control lamp).
- Certain vehicle components, e.g. the rear bumper, must be removed and reinstalled. The towing bracket securing bolts must be tightened using a torque wrench, and a power socket must be connected to the vehicle electrical system. This requires specialised knowledge and tools.
- Figures in the illustration show the elevation value and the attachment points which must be considered if you are retrofitting a towing bracket.



WARNING

The towing brackets should be fitted at a specialised workshop.

- If the towing bracket is incorrectly installed, there is a serious danger of accident.
- For your own safety, please observe the instructions provided by the manufacturer of the towing bracket.



CAUTION

- If the power socket is incorrectly installed, this could cause damage to the vehicle electrical system. ▶

**Note**

- SEAT recommends that the towing hooks be fitted at a specialised workshop. In certain versions this may entail fitting a heat insulating plate, which is why it is recommended that you go to a SEAT Dealer. In the event that the plate is not installed correctly, SEAT is exempt from any liability.
- Due to the specific design of the exhaust, the fitting of a conventional towing hook is not recommended for some sportier versions. Please consult your Technical Service. ■

Care and cleaning

General information

Regular care helps to maintain the value of the vehicle.

Regular and careful care helps to **maintain the value** of the vehicle. This may also be one of the requirements for upholding any warranty claims in the event of corrosion or paint defects.

SEAT Official Services and specialist retailers carry stocks of suitable **car care materials**. Please follow the instructions for use on the packaging.



WARNING

- **Cleaning products and other materials used for car care can be damaging to your health if misused.**
- **Always keep care products in a safe place, out of the reach of children. Failure to comply could result in poisoning.**



For the sake of the environment

- If possible, use environmentally friendly products.
- The remains of car care products should not be disposed of with ordinary household waste.

Care of vehicle exterior

Washing the vehicle

The longer substances such as insects, bird droppings, resinous tree sap, road dirt, industrial deposits, tar, soot or road salt and other aggressive materials remain on the vehicle, the more damage they do to the paintwork. High temperatures (for instance due to strong sunlight) further intensify the corrosive effect.

After the period when salt is put on the roads it is important to have the underside of the vehicle washed thoroughly.

Automatic car washes

Before going through a car wash, be sure to take the usual precautions such as closing the windows and roof. If the vehicle has special accessories such as spoilers or a roof carrier or two-way radio aerial, etc., it is advisable to consult the car wash operator.

It is best to use a car wash without revolving bristles if possible.

Washing the vehicle with a high pressure cleaner

When washing the vehicle with a high-pressure cleaner, always follow the operating instructions for the equipment. This applies particularly to the **operating pressure** and the **spraying distance**. Do not hold the nozzle too close to soft materials such as rubber hoses or seals. The same applies to the parking aid sensors*, which are located in the rear bumper.

Do not use a nozzle that sprays the water out in a **direct stream** or one that has a **rotating jet** for forcing off dirt. ▶

Washing the car by hand

When washing the car by hand, use plenty of water to soften the dirt first, and rinse off as well as possible.

Then clean the vehicle with a soft **sponge, glove or brush** using only slight pressure. You should start on the roof and work down. Special **car shampoo** should only be used for very persistent dirt.

Rinse the sponge or glove thoroughly and often.

Wheels, sills and similar should be cleaned last. Use a second sponge for this.

WARNING

- The vehicle should only be washed with the ignition switched off. Failure to do so could result in an accident.
- Do not clean the underside of chassis, the inside of wheel arches or wheel trims without protecting your hands and arms. You may cut yourself on sharp-edged metal parts. Otherwise, there is a risk of sustaining cuts.
- When washing the car during the winter season: water and ice in the brake system can reduce braking effectiveness: risk of accident!



CAUTION

- Do not wash the vehicle in direct sunlight – otherwise the paint can be damaged.
- Do not use sponges, abrasive household sponges or similar to clean insect remains. This could damage the surface.
- Clean off stubborn dirt (insects, etc.) from the headlights at regular intervals, for instance when filling the fuel tank. The headlights should only be washed with water, do not wipe them with a dry cloth or sponge. It is best to use soapy water.

- Never wash tyres with a jet that sprays the water out in a direct stream. This could damage the tyres even if the spray is kept at a distance and only used for a very short time.
- Before washing the vehicle in an automatic car wash, please make sure to retract the exterior mirrors to prevent them from being damaged. Electrically retractable exterior mirrors must not be folded in or out by hand. Always use the electrical power control.



For the sake of the environment

The car should only be washed in special wash bays. This prevents oily water from getting into the public drains. In some places, washing vehicles anywhere else may be prohibited.

Sensors and camera lenses

- Use a small brush to remove snow and a de-icer spray to remove ice.
- Clean the sensors with a solvent-free product and a soft, dry cloth.
- Moisten the camera lens using a standard alcohol-based glass cleaning agent and clean the lens with a dry cloth. The area in front of the active Lane Assist* lens area is normally cleaned with the windscreen washer.



CAUTION

- When you clean the vehicle with a pressure washer,
 - stay a suitable distance from the sensors on the front and rear bumpers.
 - Do not clean the camera lenses or surrounding area with the pressure washer.
- Never use warm or hot water to remove snow and ice from the reverse camera lens, as it could crack the lens.
- Never use abrasive cleaning agents on the lens.

Care and polishing

Care

Waxing protects the paintwork. It is time to apply a good coat of **wax** when water no longer **forms droplets** and rolls off the clean paintwork.

Even if a **wax solution** is used regularly in the vehicle washing tunnel, it is advisable to protect the paint with a hard wax coating at least twice a year.

In the summer, you will find it is much easier to remove dead insects (which accumulate on the bumper and the front of the bonnet) if the car has been treated with care products *recently*.

Polishing

Polishing is only necessary if the paint has lost its shine, and the gloss cannot be brought back by putting on wax.

If the polish does not contain wax, a wax product should be applied after polishing.



CAUTION

- Do not use polishes and hard wax on painted parts with a matt finish or on plastic parts.
- Do not apply paint polishes to the side trim that runs around the panoramic roof and ends on the windscreen. However, it can be treated with hard wax.

Trims

In respect for the environment, the silver-plated trims on the body are made of pure aluminium (they do not contain chrome).

Dirt or marks on the trim mouldings should be removed with a **cleaning product with a neutral PH** (do not use a chrome cleaner). Body polish is also

unsuitable for use on trim mouldings. The intensive cleaning fluids often used before the car goes into a car wash may contain alkaline substances, which can cause dull or milky patches when they dry out.

SEAT Official Services carry stocks of cleaning products which have been tested for use on your vehicle and are not harmful to the environment. ■

Plastic parts

Plastic parts are cleaned with a power washer. If this is not sufficient, plastic parts should only be treated with a special solvent-free **plastic cleaning agent**. Do not use paintwork cleaners, polishes or wax on plastic parts. ■

Carbon components

The carbon parts on your vehicle have a painted surface. They do not need any special care and are cleaned just like any other painted part ⇒ page 198. ■

Paint damage

Minor damage to the paint, such as scratches or stone chips, should be touched up *without delay* before the metal starts to corrode. Suitable **touch-up brushes** or **sprays** for your car can be obtained from a SEAT Official Service.

The number of the original paint finish on the vehicle is given on the data sticker ⇒ page 264.

If corrosion is already visible it must be thoroughly removed by a specialised workshop. ■

Windows

Clear vision is an essential safety factor.

The windscreen must not be cleaned with insect remover or wax, otherwise the windscreen wipers will not function properly (juddering).

Traces of rubber, oil, grease or silicone can be removed with a **window cleaning solution** or a **silicone remover**. Wax residue can only be removed with a special cleaner. Your SEAT Official Service will be able to provide you with more detailed information.

The windows should also be cleaned on the inside at regular intervals.

Use a separate cloth or chamois to dry the windows. Cloths used for waxing and polishing contain residues that will cause smears on the glass.



WARNING

Do not use water-repellent coatings on the windscreen. In bad visibility conditions (e.g. in the rain, dark or with a low sun), these coatings may cause dazzle: risk of accident! Such coatings can also cause the windscreen wiper blades to make noise.



CAUTION

- Remove snow and ice from windows and exterior mirrors with a **plastic scraper** only. To avoid scratches caused by dirt on the glass, the scraper should only be pushed in one direction and not moved to and fro.
- The heating element for the rear window is located on the inner side of the window. To avoid damaging them, do not apply stickers to the heating elements.
- Never use warm or hot water to remove snow and ice from windows and mirrors. This could cause the glass to crack!

Rims

The wheels require regular attention to preserve their appearance. It is important to remove road salt and brake dust by washing the wheels at regular intervals, otherwise the finish will be impaired.

After washing, the wheels should only be cleaned with an "acid-free" cleaning agent for alloy wheels. This is available from SEAT Official Services and specialist retailers. Never leave the cleaning agent on the rims for any longer than specified in the instructions before rinsing it off. If the wheel cleaner fluid contains acid it can attack the surfaces of the wheel bolts.

Car polish or other abrasive agents should not be used for maintaining the rims. If the protective coating is damaged, e.g. by stone impact, the damaged area should be touched up immediately.



WARNING

Please note when cleaning the wheels that water, ice and road salt can impair the effectiveness of the brakes; this can cause an accident.

Exhaust tail pipe

It is important to remove road salt and brake dust by washing the wheels at regular intervals, otherwise the exhaust tail pipe material could be damaged. To remove impurities, do not use rim, paint or chrome cleaners or other abrasive products. Clean the exhaust tail pipes with cleaning products that are suitable for stainless steel.

SEAT Official Services carry stocks of cleaning products that have been tested and approved for use on your vehicle.

Care of the vehicle interior

Radio display/Easy Connect* and control panel*

The display can be cleaned with a soft cloth and a professionally available "LCD cleaner". Moisten the cloth with a small amount of the cleaning fluid.

The Easy Connect control panel* should first be cleaned with a brush so that no dirt goes into the device or between the keys and housing. Next, we recommend cleaning the Easy Connect control panel* using a cloth dampened with water and washing-up liquid.



CAUTION

- To avoid scratching the screen, do not wipe the display with a dry cloth.
- To avoid damage, ensure that no liquid goes into the Easy Connect control panel*.

Plastic and leatherette parts

Plastic parts and leatherette can be cleaned with a damp cloth. If this is not sufficient, plastic parts and leatherette should only be treated with a **special solvent-free plastic cleaner**.

Textile covers and trim parts

Textile covers and trim parts (e.g. seats, door trim) should be cleaned regularly with a vacuum cleaner. This will remove surface dirt which could otherwise be rubbed into the textile material during use. Do not use steam cleaners, as the steam could carry the dirt deeper into the textile material.

Normal cleaning

We recommend that you use a soft sponge or a commercially available lint-free, micro-fibre cloth for normal cleaning. Only use brushes on floor coverings and mats, as other textile surfaces could become damaged.

In the case of normal surface dirt you can use a foam cleaner. Use a sponge to spread the foam on the textile surface and to work it into the material lightly. However, make sure that the textile material does not become soaking wet. Then dab off the foam with a dry and absorbent cloth (e.g. a micro-fibre cloth) and vacuum off any residue once the surface is completely dry.

Cleaning stains

Treat drink stains (such as coffee or fruit juice, etc.) with a cleaning solution for delicate fabrics. The cleaning product solution should be applied with a sponge. If the stains are difficult to remove, a washing paste can be applied directly onto the stain and worked into the fabric. The surface will then have to be wiped with clear water to remove any residue left by the paste. To do so, use a damp cloth or sponge and then dab the stain with an absorbent cloth.

Remove chocolate or make-up stains with a cleaning paste (for e.g., soft soap). Then remove the soap with water (wet sponge).

A spirit-based cleaner can be used to remove grease, oil, lipstick or ball point pen. Then dab the dissolved grease or colour particles off with an absorbent cloth or similar. You may also have to treat the stain once more using washing paste and water.

If the covers or textile trim panels are badly soiled we recommend that you have them cleaned by a professional cleaning company with a shampoo and spray.



Note

Open Velcro fasteners on clothes can damage the seat upholstery. Make sure that Velcro fasteners are closed.

Natural leather

SEAT does everything possible to preserve the genuine qualities of this natural product.

General information

Our range of leathers is large. The main type used is nappa in various forms, that is, leather with a smooth surface in various different colours.

The amount of dye used determines the appearance and properties of leather. If the leather is left in a more natural state, it retains its typical natural napped appearance and confers excellent all-weather properties to the seats. Fine veins, healed scars, insect bites, wrinkles and a subtle variation in shading remain visible; these are the characteristic features of genuine natural leather.

Natural napped leather does not have a protective surface coating of dye. It is therefore somewhat more prone to damage. This should be borne in mind if children or pets often travel in the car, or if there are other factors that could lead to damage.

Types of leather with a coloured surface coating are likely to be more resistant to damage. This has a great advantage for day-to-day use. However, this means that the typical natural characteristics of the surface are less apparent, though this does not affect quality.

Cleaning and care

Due to the natural properties of the specially selected hides employed, the finished leather has a certain sensitivity to grease and dirt, etc. so a degree of care is required in everyday use and when looking after the leather. Dark clothing (especially if damp or incorrectly dyed) may stain leather upholstery. Dust and grit in the pores and seams can scratch and damage the surface. Therefore leather should be cleaned at regular intervals, depending on the actual amount of use. When they have been in use for a certain time, your car seats will acquire a typical and unmistakable patina. This is characteristic for leather as a natural product and is a sign of genuine quality.

To maintain the value of natural leather you should note the following points:

CAUTION

- Avoid exposing leather to direct sunlight for long periods, otherwise it may tend to lose some of its colour. If the car is left for a prolonged period in the bright sun, it is best to cover the leather.
- Sharp-edged objects on clothing, such as belts, zip fasteners, rivets or similar, can also leave permanent scratches and rough marks on the surface of the leather.

Note

- Use a suitable impregnating cream with ultra-violet protection at regular intervals and after cleaning. The cream nourishes and moisturises the leather, keeps it supple and able to breathe. It will also form a protective film.
- Clean the leather every 2 to 3 months and remove fresh dirt as soon as possible.
- Remove stains from fresh ball-pen and other inks, lipstick, shoe cream and similar stains as soon as possible.
- Preserve the colour of the leather. A special coloured cream will renew the colour of the leather when required and will eliminate differences in colour. ■

Cleaning and care of leather upholstery

Natural leather requires an extra degree of attention and care.

Normal cleaning

- Moisten a cotton or woollen cloth with water and wipe over the leather surfaces. ►

More stubborn dirt

- More stubborn dirt can be removed using a mild soap solution (pure liquid soap: two tablespoons dissolved in one litre of water).
- Do not let the water soak through the leather or penetrate into the seams.
- Then wipe off with a soft, dry cloth.

Removal of stains

- Remove fresh **water-based** stains such as coffee, tea, juices, blood etc. with an absorbent cloth or kitchen roll, dried-on stains with the cleaning agent from the care set.
- Remove fresh **fat-based** stains that have not penetrated the surface such as butter, mayonnaise, chocolate, etc. with an absorbent cloth or kitchen roll or with the cleaning agent from the care set.
- Treat **fat-based, dried-in** stains with grease-dissolving spray.
- Treat **less common stains** such as ball-pen and other inks, felt-tip pens, nail polish, dispersion paint, shoe cream etc. with a special leather stain remover.

Leather maintenance

- The leather should be treated regularly (about twice a year) with a special leather-care product.
- Apply these products very sparingly.
- Then wipe off with a soft, dry cloth.

Should you have questions regarding the care and cleaning of the leather upholstery in your vehicle, we recommend that you contact your SEAT Official Service. Our representatives will be happy to advise you and tell you about the product range for leather conservation, for example:

- Cleaning and care set
- Coloured leather-care cream
- Stain remover for ball-pen inks, shoe cream etc.
- Grease dissolving spray
- New products and further developments



CAUTION

On no account use solvents (such as petrol, turpentine), wax polish, shoe cream or similar materials. ■

Cleaning Alcantara upholstery

Removing dust and dirt

- Moisten a cloth *just a little* and wipe down the seat covers.

Removing stains

- Moisten a cloth with lukewarm water or diluted **white spirits**.
- Dab at the stain. Start at the outside and work inwards.
- Dry the area you have cleaned with a soft cloth.

Do not use leather cleaning products on Alcantara seat covers.

You may use a suitable shampoo on dust and dirt.

Dust and grit in the pores and seams can scratch and damage the surface. If the car is left standing in the sun for long periods, Alcantara leather should ►

be protected against direct sunlight to prevent it from fading. However, slight colour variations will arise in normal use.

 **CAUTION**

- Do not use solvents, wax polish, shoe cream, stain removers, leather cleaning products or any similar products on Alcantara.
- To avoid damage, stubborn stains should be removed by a specialised workshop.
- On no account use brushes, hard sponges or similar utensils. ■

Seat belts

- Keep the seat belts clean.
- For cleaning, use a mild solution of soap and water.
- Check the condition of the seat belts at regular intervals.

The retract function may not operate properly in very dirty belts. Make sure that the inertia reel seat belts are completely dry before allowing them to retract.

 **CAUTION**

- Do not remove the seat belts from the vehicle to clean them.
- Do not use chemical cleaning agents on the seat belts, as this can damage the webbing. Ensure that the seat belts do not come into contact with corrosive fluids.
- If you find any damage to the belt webbing, belt fittings, the belt retractor or the buckle, the belt in question must be replaced by a specialised workshop. ■

Checking and refilling levels

Fuel

Types of petrol

The correct grade of petrol is listed inside the fuel tank flap.

The vehicle is equipped with a catalytic converter and must only be run on **unleaded petrol**. The petrol must comply with European Standard EN 228 or German standard DIN 51626-1 and must be **unleaded**. You can refuel with a maximum ethanol proportion of 10 % (E10). The types of petrol are differentiated by their **octane rating (RON)**.

The following titles appear on the corresponding adhesive on the fuel tank flap:

Super unleaded 95 octane or normal 91 octane unleaded petrol

We recommend you use super 95 octane petrol. If this is not available: normal 91 octane petrol, with a slight decrease in power.

Super unleaded petrol with a minimum of 95 octanes

You should use super petrol with a minimum of 95 octanes.

If super is not available, *in an emergency* you may refuel with normal 91 octane petrol. In this case only use moderate engine speeds and a light throttle. Refuel with super as soon as possible.

Super unleaded 98 octane or super 95 octane unleaded petrol

We recommend you use super plus 98 octane petrol. If this is not available: super 95 octane petrol, with a slight decrease in power.

If super is not available, *in an emergency* you may refuel with normal 91 octane petrol. In this case only use moderate engine speeds and a light throttle. Refuel with super as soon as possible.



CAUTION

- **Never** refuel with fuels containing a large proportion of ethanol (for example, E50, E85). This could damage the fuel system.
- Just filling one full tank of leaded fuel or fuel containing other metal additives would seriously impair the efficiency of the catalytic converter.
- Only use fuel additives that have been approved by SEAT. Octane boosting or anti-knock additives may contain metal additives that could seriously damage the engine or the catalytic converter. These additives must not be used.
- Do not refuel if the filler indicates that the fuel contains metal. LRP (lead replacement petrol) fuels also contain high concentrations of metal additives. This could damage the engine!
- High engine speed and full throttle can damage the engine when using petrol with an octane rating lower than the correct grade for the engine.



Note

- You may use petrol with a high octane number than the one recommended for your engine.
- In those countries where unleaded petrol is not available, you may refuel with a fuel with a low lead content. ■

Diesel Fuel

Please note the information on the inside of the fuel tank flap.

We recommend the use of **Diesel** fuel which complies to European standard EN 590. If diesel fuel which meets European standard EN 590 is not available, the Cetane number (CZ) must, at minimum, be 51. If the engine is equipped with a particulate filter, the sulphur content of the fuel must be below 50 parts per million.

Winter-grade diesel

Summer fuel becomes thicker in winter and it is more difficult to start the engine. For this reason petrol stations in some countries also offer winter diesel with improved fluidity when cold.

CAUTION

- The vehicle is **not** designed for the use of biodiesel (FAME fuel). The fuel system would be damaged if you used biodiesel.
- Do not mix fuel additives, the so-called “thinners”, petrol or similar additives with diesel fuel.
- If poor-quality diesel fuel is used, it may be necessary to drain the **fuel filter** more frequently than is specified in the Service Plan. We recommend having this done by a specialised workshop. If water is allowed to collect in the filter, this can cause engine performance problems.

Filling the tank

Filling the tank

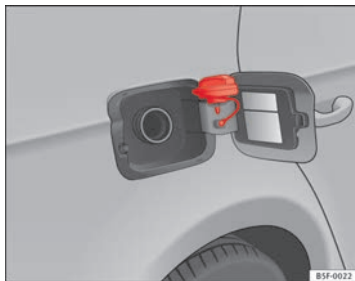

Fig. 106 Fuel tank flap with tank cap attached

The flap that covers the tank cap is unlocked and locked automatically by the central locking.

Opening the fuel tank cap

- Open the fuel tank flap, by pressing on the left side.
- Unscrew the fuel tank cap anti-clockwise.
- Place the cap in the housing on the hinge of the open flap
⇒ Fig. 106.

Closing the fuel tank cap

- Screw on the tank cap clockwise until it you hear it click into position. ▶

- Close the tank flap. Make sure you hear it click into place.

If the automatic filler nozzle is operated correctly, it will switch itself off as soon as the fuel tank is “full”. Do not try to put in more fuel after the nozzle cuts out, as this will fill the expansion chamber in the fuel tank.

The correct fuel grade for your vehicle is given on a sticker on the inside of the fuel tank flap. Further notes on fuel can be found at ⇒ page 206.

The capacity of the fuel tank is listed in the vehicle **technical specifications** ⇒ page 276.



WARNING

Fuel is highly flammable and can cause serious burns and other injuries.

- Do not smoke when filling the fuel tank or a canister. Naked flames are forbidden in the vicinity due to the risk of explosion.
- Observe legislation governing the use, storage and carrying of a spare fuel canister in the vehicle.
- For safety reasons we do not recommend carrying a spare fuel canister in the vehicle. In an accident the canister could be damaged and could leak.
- If, in exceptional circumstances, you have to carry a spare fuel canister, please observe the following points:
 - Never fill fuel into the spare fuel canister if it is inside or on top of the vehicle. An electrostatic charge could build up during filling, causing the fuel vapour to ignite. Danger of explosion. Always place the canister on the ground to fill it.
 - Insert the filling nozzle as far as possible into the spare fuel canister.



WARNING (Continued)

- If the spare fuel canister is made of metal, the filling nozzle must be in contact with the canister during filling. This helps prevent an electrostatic charge building up.
- Never spill fuel in the vehicle or in the luggage compartment. Fuel vapour is explosive. Risk of fatal accident!



CAUTION

- If any fuel is spilt onto the vehicle, it should be removed immediately. It could otherwise damage the paintwork.
- Never run the tank completely dry. An irregular fuel supply could cause misfiring. As a result, unburnt fuel could enter the exhaust system and damage the catalytic converter.
- When filling the fuel tank after having run it completely dry on a vehicle with a **diesel engine**, the ignition must be switched on for at least 30 seconds before starting the engine. When you then start the engine it may take longer than normal (up to one minute) for the engine to start firing. This is because air needs to be bled from the fuel system while starting.



For the sake of the environment

Do not overfill the fuel tank – it may cause the fuel to overflow if it becomes warm. ▶

**Note**

Diesel vehicles are fitted with a protective device that prevents the insertion of the wrong fuel hose¹⁾. It is only possible to refuel with Diesel nozzles.

- If the pump nozzle is worn, damaged, or if it is very small, it is possible that it will not be able to open the protective device. Before trying to insert the pump nozzle by turning it, try a different pump or request specialist help.
- If you fill the tank from a reserve fuel canister, the protective device will not open. One way to resolve this is to pour the fuel in very slowly. ■

Bonnet

Working on components in the engine compartment

Extra caution is necessary when working on components in the engine compartment.

Always be aware of the danger of injury and scalding as well as the risk of accident or even fire when working in the engine compartment (e.g. when checking and refilling fluids). Always observe the warnings listed below and follow all general safety precautions. The engine compartment of the vehicle is a potentially hazardous area ⇒ ⚠.

**WARNING**

- Switch the ignition off.
- Remove the ignition key.

**WARNING (Continued)**

- Apply the handbrake.
- If the vehicle has a manual gearbox, place the lever in neutral; if it has an automatic gearbox, place the selector lever in position P.
- Wait for the engine to cool down.
- Keep children away from the engine compartment.
- Never spill liquids used for vehicle operation on the engine compartment, as these may catch fire (e.g. the antifreeze in coolant).
- Take care not to cause short circuits in the electrical system, especially when working on the battery.
- If working inside the engine compartment, remember that, even when the ignition is switched off, the radiator fan may start up automatically, and therefore there is a risk of injury.
- Do not unscrew the cap on the coolant expansion tank when the engine is hot. The cooling system is under pressure.
- Protect face, hands and arms by covering the cap with a large, thick rag to protect against escaping coolant and steam.
- If it is necessary to work in the engine compartment while the engine is running, the rotating components (for example, poly-V belt, alternator, radiator fan) and the high voltage ignition system are an additional hazard.
- Observe the following additional warnings if work on the fuel system or the electrical system is necessary:
 - Always disconnect the battery from the on-board network.
 - Do not smoke.
 - Never work near naked flames.
 - Always keep an approved fire extinguisher immediately available. ▶

¹⁾ according to the country

⚠ CAUTION

When changing or topping up service fluids, make absolutely certain that you fill the fluids into the correct reservoirs. Using the wrong fluids could cause serious malfunctions and engine damage!

🌿 For the sake of the environment

Inspect the ground underneath your vehicle regularly so that any leaks are detected at an early stage. If you find spots of oil or other fluids, have your vehicle inspected at the workshop.

📄 Note

On right-hand drive vehicles* some of the containers/reservoirs mentioned below are located on the other side of the engine compartment.

Opening the bonnet

The bonnet is released from inside the vehicle.

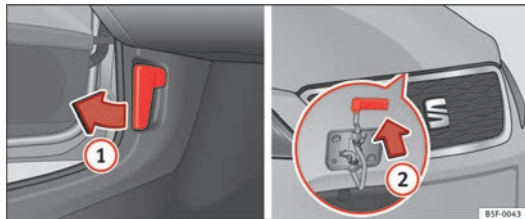

Fig. 107 Release lever in driver footwell and cam below the bonnet

Check that the windscreen wiper arms are not unfolded. Otherwise the paint may be damaged.

The bonnet can only be unlocked when the driver door is open.

- Pull the lever under the dash panel in the direction of the arrow (1) ⇒ Fig. 107.
- Lift the bonnet slightly ⇒ ⚠.
- Press the release catch under the bonnet upwards ⇒ Fig. 107 (2). This will release the arrester hook under the bonnet.
- Open the bonnet.

⚠ WARNING

Never open the bonnet if you see steam or drips of coolant being released from the engine compartment. Failure to comply could result in burns. Wait until no steam or coolant can be seen before opening the bonnet.

Closing the bonnet

- Press the bonnet down until it locks into place.
- Make sure that the bonnet catches onto its clasp. *Do not press down too hard* ⇒ ⚠.

 **WARNING**

- For safety reasons the bonnet must always be completely closed when the vehicle is moving. Therefore, after closing the bonnet, always check that the locking element is properly engaged. This is the case if the bonnet is flush with the adjacent body panels.
- Should you notice that the bonnet is not safely secured when the vehicle is moving, stop the vehicle immediately and close the bonnet. Failure to do so could result in an accident.

Engine oil

General notes

The engine comes with a special, multi-grade oil that can be used all year round.

Because the use of high-quality oil is essential for the correct operation of the engine and its long useful life, when topping up or changing oil, use only those oils that comply with VW standards.

The specifications (VW standards) set out in the following page should appear on the container of the service oil; when the container displays the specific standards for petrol and diesel engines together, it means that the oil can be used for both types of engines.

We recommend that the oil change, indicated in the Maintenance Programme, be performed by a Technical Service or a specialised workshop.

The correct oil specifications for your engine are listed in ⇒ page 212, Oil properties.

Service intervals

Service intervals can be flexible (LongLife service) or fixed (dependent on time/distance travelled).

If the PR code that appears on the back of the “Maintenance Programme” booklet is PR QJ6, this means that your vehicle has the LongLife service programmed. If it lists the codes QJ1, QJ2, QJ3, QJ4 or QJ7, the interval service is dependent on time/distance travelled.

Flexible service intervals (LongLife service intervals*)

Special oils and processes have been developed which, depending on the characteristics and individual driving profiles, enable the extension of the oil change service (LongLife service intervals).

Because this oil is essential for extending the service intervals, it **must only** be used observing the following indications:

- Avoid mixing it with oil for fixed service intervals.
- Only in exceptional circumstances, if the engine oil level is too low ⇒ page 212 and LongLife oil is not available, it is permitted to top up (once) with oil for **fixed service intervals** ⇒ page 212 (up to a maximum of 0.5 litres).

Fixed service intervals*

If your vehicle does not have the “LongLife service interval” or it has been disabled (by request), you may use oils for **fixed service intervals**, which also appear in ⇒ page 212, Oil properties. In this case, your vehicle must be serviced after a fixed interval of 1 year/15 000 km (10 000 miles)(whatever comes first) ⇒ Booklet Maintenance Programme.

- In exceptional circumstances, if the engine oil level is too low ⇒ page 212 and you cannot obtain the oil specified for your vehicle, you can put in a small quantity of oil conforming to the specification ACEA A2 or ACEA A3 (petrol engines) or ACEA B3 or ACEA B4 (diesel engines) (up to 0.5 l).

Vehicles with diesel particulate filter*

The "Maintenance Programme" states whether your vehicle is fitted with a diesel particulate filter.

Only VW 507 00 engine oil, with reduced ash formation, may be used in diesel engines equipped with particulate filter. Using other types of oil will cause a higher soot concentration and reduce the life of the DPF. Therefore:

- Avoid mixing this oil with other engine oils.
- Only in exceptional circumstances, if the engine oil level is too low → page 212 and you cannot obtain the oil specified for your vehicle, you can use a small quantity of oil (once) conforming to the VW 506 00, VW 506 01, VW 505 00, VW 505 01 or ACEA B3/ACEA B4 specification. (up to 0.5 l).

Oil properties

Engine type	Specification
Petrol without flexible service interval	VW 502 00/VW 504 00
Petrol with flexible service interval (LongLife)	VW 504 00
Diesel. Engines without Particulate filter (DPF)	VW 505 01/VW 506 01/VW 507 00
Diesel. Particulate Filter Engines (DPF). With or without flexible service interval (with and without LongLife) ^{a)}	VW 507 00

^{a)} Only use recommended oils, otherwise you may damage the engine.

Engine oil additives

No type of additive should be mixed with the engine oil. The deterioration caused by these additives is not covered by the warranty.

Note

Before a long trip, we recommend finding an engine oil that conforms to the corresponding VW specifications and recommend keeping it in the vehicle. This way, the correct engine oil will always be available for a top-up if needed. ■

Checking engine oil level

The engine oil dipstick indicates the level of the oil.

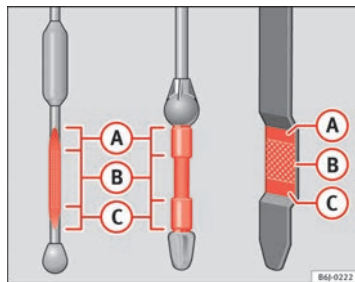

Fig. 108 Engine oil dipstick

Checking oil level

- Park the vehicle in a horizontal position. ▶

- Briefly run the engine at idle speed until the operating temperature is reached and then stop.
- Wait two minutes.
- Pull out the dipstick. Wipe the dipstick with a clean cloth and insert it again, pushing it in as far as it will go.
- Then pull it out once more and check the oil level ⇒ Fig. 108. Top up with engine oil if necessary.

Oil level in area **A**

- Do **not** add oil ⇒ ①.

Oil level in area **B**

- You **can** add oil, but keep the level in this zone.

Oil level in area **C**

- Oil **must** be added. **Afterwards**, the oil level should be in the lined area **B**.

Depending on how you drive and the conditions in which the vehicle is used, oil consumption can be up to 0.5 l/1000 km. Oil consumption is likely to be higher for the first 5000 km. For this reason the engine oil level must be checked at regular intervals, preferably when filling the tank and before a journey.

! WARNING

Any work carried out in the engine compartment or on the engine must be carried out cautiously.

- When working in the engine compartment, always observe the safety warnings ⇒ page 209.

! CAUTION

If the oil level is above the area **A** do not start the engine. This could result in damage to the engine and catalytic converter. Contact a Technical Service.

Topping up engine oil

Top up gradually with small quantities of engine oil.



Fig. 109 In the engine compartment: Engine oil filler cap

Before opening the bonnet, read and observe the warnings ⇒ **!** in Working on components in the engine compartment on page 209.

- Unscrew cap from engine oil filler opening ⇒ Fig. 109.
- Top-up oil in small amounts, using the correct oil.
- To avoid over-filling with engine oil, you should top-up using small quantities, wait a while and check the oil level before adding any more oil.

– As soon as the oil level is in area **(B)**, carefully close the cap.

The position of the oil filler opening is shown in the corresponding engine compartment illustration ⇒ page 267.

Engine oil specification ⇒ page 211.



WARNING

Oil is highly inflammable! Ensure that no oil comes into contact with hot engine components when topping up.



CAUTION

If the oil level is above the area **(A)** do not start the engine. This could result in damage to the engine and catalytic converter. Contact a specialised workshop.



For the sake of the environment

The oil level must never be above area **(A)**. Otherwise oil can be drawn in through the crankcase breather and escape into the atmosphere via the exhaust system. ■

Changing engine oil

The engine oil must be changed at the intervals given in the service schedule.

We recommend that you have the engine oil changed by a Technical Service.

The oil change intervals are shown in the Maintenance Programme.



WARNING

Only change the engine oil yourself if you have the specialist knowledge required!

- Before opening the bonnet, read and observe the warnings ⇒ page 209.
- Wait for the engine to cool down. Hot oil may cause burn injuries.
- Wear eye protection to avoid injuries, such as acid burns, caused by splashes of oil.
- When removing the oil drain plug with your fingers, keep your arm horizontal to help prevent oil from running down your arm.
- Wash your skin thoroughly if it comes into contact with engine oil.
- Engine oil is poisonous! Used oil must be stored in a safe place out of the reach of children.



CAUTION

No additives should be used with engine oil. This could result in engine damage. Any damage caused by the use of such additives would not be covered by the factory warranty.



For the sake of the environment

- Because of the disposal problems, the necessary special tools and specialist knowledge required, we recommend that you have the engine oil and filter changed by a Technical Service.
- Never pour oil down drains or into the ground.
- Use a suitable container when draining the used oil. It must be large enough to hold all the engine oil. ■

Cooling system

Engine coolant specifications

The engine cooling system is supplied from the factory with a specially treated mixture of water and, at least, 40 % of the additive **G 13** (TLVW 774 J). The engine coolant additive is recognisable by its purple colour. This mixture of water and additive gives the necessary frost protection down to -25°C (-13 F) and protects the light alloy parts of the cooling system against corrosion. It also prevents scaling and considerably raises the boiling point of the coolant.

To protect the engine cooling system, the percentage of additive must *always* be at least 40 %, even in warm climates where anti-freeze protection is not required.

If greater frost protection is required in very cold climates, the proportion of additive can be increased. However, the percentage of additive should not exceed 60 %, as this would reduce the frost protection and, in turn, decrease the cooling capacity.

When the coolant is topped up, use a mixture of **distilled water** and, at least, 40 % of the G 13 or G 12 plus-plus (TL-VW 774 G) additive (both are purple) to obtain an optimum anticorrosion protection ⇒ ①. The mixture of G 13 with G 12 plus (TL-VW 774 F), G 12 (red) or G 11 (green-blue) engine coolants will significantly reduce the anticorrosion protection and should, therefore be avoided ⇒ ①.



WARNING

If there is not enough anti-freeze in the coolant system, the engine may fail leading to serious damage.

- Please make sure that the percentage of additive is correct with respect to the lowest expected ambient temperature in the zone in which the vehicle is to be used.
- When the outside temperature is very low, the coolant could freeze and the vehicle would be immobilised. In this case, the heating would not work either and inadequately dressed passengers could die of cold.



CAUTION

The original additives should never be mixed with coolants which are not approved by SEAT. Otherwise, you run the risk of causing severe damage to the engine and the engine cooling system.

- If the fluid in the expansion tank is not purple but is, for example, brown, this indicates that the G 13 additive has been mixed with an inadequate coolant. The coolant must be changed as soon as possible if this is the case! This could result in serious faults and engine damage.



For the sake of the environment

Coolants and additives can contaminate the environment. If any fluids are spilled, they should be collected and correctly disposed of, with respect to the environment. ■

Topping up coolant

Top up coolant when the level is below the MIN (minimum) mark.



Fig. 110 Engine compartment: Coolant expansion tank cap

Checking coolant level

- Park the vehicle in a horizontal position.
- Switch the ignition off
- Read off the coolant level on coolant expansion tank. When the engine is cold, the coolant level should be between the marks. When the engine is hot, it may be slightly above the upper mark.

Topping up coolant

- Wait for the engine to cool down.
- Cover the coolant expansion tank cap with a cloth and carefully unscrew it to the left ⇒ ⚠.

- Top up the coolant only if there is still coolant in the expansion tank, otherwise you could **damage the engine**. If there is no coolant in the expansion tank, do not continue driving. You should obtain professional assistance ⇒ ⓞ.
- If there is still some coolant in the expansion tank, top up to the upper mark.
- Top up with coolant to the upper mark until the level becomes stable.
- Screw the cap back on correctly.

Any loss of coolant fluid normally indicates a leak in the cooling system. Take the vehicle straight to a specialised workshop to have the cooling system examined. If there are no leaks in the engine cooling system, a loss of coolant can only occur if the coolant boils and is forced out of the system as a result of overheating.



WARNING

- The cooling system is under pressure. Do not unscrew the cap on the coolant expansion tank when the engine is hot: risk of burns!
- The antifreeze and coolant fluid can be a health hazard. Therefore, the antifreeze should be stored in the original container in a safe place out of reach of children. Failure to comply could result in poisoning.
- If working inside the engine compartment, remember that, even when the ignition is switched off, the radiator fan may start up automatically, and therefore there is a risk of injury.



CAUTION

Do not top up the expansion tank with coolant fluid if it is empty! Air could enter the cooling system. In this case, stop driving. Seek specialist assistance. Otherwise, there is a risk of engine damage.

Brake fluid



Fig. 111 Engine compartment: brake fluid reservoir, lid

Checking the brake fluid level

The brake fluid level must be between the MIN and MAX markings.

However, if the brake fluid level goes down noticeably in a short time, or drops below the MIN mark, there may be a leak in the brake system. Seek specialist assistance. A warning light on the instrument panel display monitors the brake fluid level ⇒ page 69.

In right-hand drive vehicles the brake fluid reservoir is on the other side of the engine compartment.

Changing brake fluid

The regular intervals at which the brake fluid should be replaced are listed in the Service Plan. We recommend you have the brake fluid replaced at a SEAT Official Service, during an Inspection Service.

⚠ WARNING

- Brake fluid should be stored in the closed original container in a safe place out of reach of children. Risk of poisoning!
- If the brake fluid is left in the system for too long and the brakes are subjected to heavy use, vapour bubbles may form in the brake system. This would seriously affect the efficiency of the brakes and the safety of the vehicle. This may cause an accident.

⚠ CAUTION

Brake fluid should not come into contact with the vehicle paintwork, as it is abrasive.

Battery

General information

The battery is located in the engine compartment and is almost **maintenance-free**. It is checked as part of the Inspection Service. Nevertheless, check the terminals are clean and have the correct tightening torque, especially in summer and winter.

Disconnecting the battery

The battery should only be disconnected in exceptional cases. When the battery is disconnected, some of the vehicles functions are "lost" (⇒ table on page 218). These functions will require resetting after the battery is re-connected.

Deactivate the anti-theft alarm* before you disconnect the battery. Otherwise the alarm will be triggered.

Function	Reprogramming
One-touch function of the electric windows	⇒ page 101, One-touch opening and closing*
Remote control key	If the vehicle does not respond to the key, they should be synchronised ⇒ page 90
Digital clock	⇒ page 63
ESC warning lamp	After driving for a few metres, the warning lamp goes out again.

If the vehicle is not used for long periods

The vehicle has a system for monitoring the current consumption when the engine is left unused for long periods of time ⇒ page 187. Some functions, such as the interior lights, or the remote door opening, may be temporarily disabled to prevent the battery from running flat. These functions will come back on as soon as the ignition is switched on and the engine started.

Winter conditions

During the winter, the starting power may be reduced, and if necessary, the battery should be charged ⇒ ⚠ in Important safety warnings for handling a vehicle battery on page 218

Important safety warnings for handling a vehicle battery

All work on batteries requires specialist knowledge. Please refer to a SEAT Official Service or a workshop specialising in batteries: risk of burns or exploding battery!

The battery must not be opened. Never try to change the fluid level of the battery. Explosive gas is released from the battery that could cause an explosion.



Wear eye protection.



Battery acid is very corrosive and caustic. Wear protective gloves and eye protection. In the event of electrolyte splashes, rinse off with plenty of water.



Fires, sparks, open flames and smoking are prohibited.



The battery should only be charged in a well-ventilated zone. Risk of explosion!



Keep children away from acid and batteries!



WARNING

- **When repairing or working on the electrical system, proceed as follows:**
 - **1. Remove the key from the ignition. The negative cable on the battery must be disconnected.**
 - **2. When the repair is finished, reconnect the negative pole of the battery.**
- **Switch off all electrical consumers before reconnecting the battery. Reconnect first the positive cable and then the negative cable. Never reverse the polarity of the connections. This could cause an electrical fire.**
- **Ensure that the vent hose is always connected to the battery.**
- **Never use damaged batteries. This could cause an explosion! Replace a damaged battery immediately.**





CAUTION

- Never disconnect the battery if the ignition is switched on or if the engine is running. This could damage the electrical system or electronic components.

Charging the battery

Terminals for charging the battery are fitted in the engine compartment.

- Note the warnings ⇒  in Important safety warnings for handling a vehicle battery on page 218 and ⇒ .
- Switch off all electrical equipment. Remove the ignition key.
- Raise the bonnet ⇒ page 210.
- Open the battery cover.
- Connect the charger clamps as described to the **positive pole of the battery (+)** and, exclusively to an **earth on the bodywork (-)**.
- Only use a charger which is compatible for use with 12 V nominal voltage batteries. The charge must not exceed a voltage of 15 V.
- Now connect the battery charger to the power socket and switch on.
- After charging the battery: switch off the battery charger and disconnect the power socket cable.
- Finally disconnect the charger cables from the battery.
- Replace the battery cover correctly.
- Close the bonnet ⇒ page 210.

Important: Before you charge the battery make sure you read the manufacturer's instructions for using the battery charger.



WARNING

Never charge a battery that has frozen: replace battery! Failure to do so may lead to an explosion.



Note

Use only the terminals in the engine compartment to charge the battery. ■

Replacing the battery

The new battery should have the same specifications (amperage, load and voltage) as the used battery.

Your vehicle is equipped with an intelligent power management system to control the distribution of electrical energy ⇒ page 187. The power management function ensures that the battery is charged much more efficiently than on vehicles without a power management system. To maintain this function after replacing the battery, we recommend that the replacement battery used is of the same make and type as the original fitted battery. To make proper use of the power management function after the battery has been changed, have the battery coded to the power management mode at a specialised workshop.



CAUTION

- Some vehicles, for example those with the Start-Stop system* are fitted with a special battery (AGM-type or EFB-type battery). If any other type of battery is fitted, the Start-Stop function may be considerably reduced and the vehicle may not stop on repeated occasions.
- Make sure that the vent hose is always attached to the original opening on the side of the battery. Gases or battery acid can otherwise escape and possibly cause damage.
- The battery holder and clamps must always be correctly secured. ►

- Before starting any work on the battery, always observe the warnings listed under ⇒ page 218, Important safety warnings for handling a vehicle battery.
- Do not forget to replace the battery coverings, where applicable. This helps to protect against excess temperatures. This in turn extends the vehicle service life.



For the sake of the environment

⚠ Batteries contain toxic substances including sulphuric acid and lead. They must be disposed of appropriately and must not be disposed of with ordinary household waste. Make sure disconnected batteries cannot tip over. Sulphuric acid could be spilled!

Windscreen washer reservoir and wiper blades

Windscreen washer



Fig. 112 Engine compartment: Windscreen washer reservoir top

The windscreen washer reservoir  contains the cleaning fluid for the windscreen, the rear window and the headlight washer system* ⇒ Fig. 112. Reservoir capacity: ⇒ page 276.

To prevent the nozzles from becoming blocked with chalk deposits, fill reservoir with water with a low calcium content (distilled water). Always add washer fluid to the water (with anti-freeze additive in winter).



CAUTION

- Never put radiator anti-freeze or other additives into the windscreen washer fluid.
- Never use washer fluid which contains paint thinners or solvents as it can damage the paintwork.

Cleaning and changing the wiper blades of the windscreen and rear window

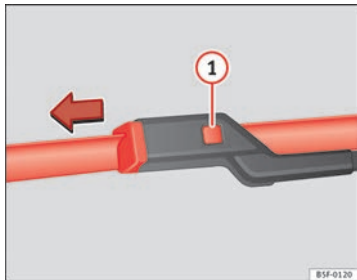

Fig. 113 Changing the windscreen wiper blades

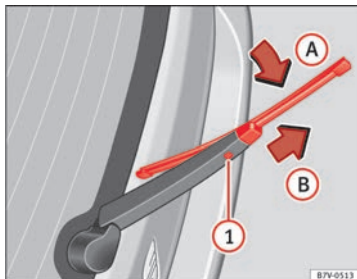

Fig. 114 Changing the rear wiper blade

The windscreen wiper blades are supplied as standard with a layer of graphite. This layer is responsible for ensuring that the wipe is silent. If the graph-

ite layer is damaged, the noise of the water as it is wiped across the windscreen will be louder.

Check the condition of the wiper blades regularly. **If the wipers scrape across the glass** they should be changed if they are damaged, or cleaned if they are dirty ⇒ ①.

Damaged wiper blades should be replaced immediately. Wiper blades are available from specialised workshops.

Raising/lowering windscreen wiper arms

For windscreen wipers, please note: the wiper should be in service position before being lowering ⇒ page 119.

When raising or lowering an arm, it should **only** be held at the blade fastening point.

Cleaning windscreen wiper blades

- Raising the wiper arms.
- Use a soft cloth to remove dust and dirt from the windscreen wiper blades.
- If the blades are very dirty, a sponge or damp cloth may be used ⇒ ①.

Changing the windscreen wiper blades

- Raising/lowering wiper arms
- Hold down the release button ⇒ Fig. 113 ① while gently pulling the blade in the direction of the arrow.
- Fit a new wiper blade of the **same length and design** on to the wiper arm and hook it into place.
- Rest the wiper arms back onto the windscreen.

Changing the rear wiper blade

- Raising/lowering the wiper arm.
- Turn the blade slightly ⇒ Fig. 114 (arrow A).
- Hold down the release button ① while gently pulling the blade in the direction of the arrow B.

- Insert a new blade of the **same length and type** in the rear wiper arm in the opposite direction to the arrow **(B)** and hook into place button **(1)**.
- Replace the wiper arm on the rear window.

**WARNING**

Worn or dirty wiper blades reduce visibility and increase the risk of accident and serious injury.

- **Always replace damaged or worn blades or blades which do not clean the windscreen correctly.**

**CAUTION**

- Damaged or dirty windscreen wipers could scratch the glass.
- If products containing solvents, rough sponges or sharp objects are used to clean the blades, the graphite layer will be damaged.
- Never use fuel, nail varnish remover, paint thinner or similar products to clean the windows. ■

Wheels and tyres

Wheels

General notes

- When driving with **new tyres**, be especially careful during the first 500 km (300 miles).
- If you have to drive over a kerb or similar obstacle, drive very slowly and as near as possible at a right angle to the obstacle.
- Check from time to time if the tyres are damaged (punctures, cuts, cracks or dents). Remove any foreign objects embedded in the treads.
- Damaged wheels and tyres must be replaced immediately.
- Keep grease, oil and fuel off the tyres.
- Replace any missing valve caps as soon as possible.
- Mark the wheels before taking them off so that they rotate in the same direction when put back.
- When removed, the wheels or tyres should be stored in a cool, dry and preferably dark place.

New tyres

New tyres do not give maximum **grip** straight away and should therefore be “run in” by driving carefully and at moderate speeds for about the first 500 km (300 miles). This will also increase the useful life of the tyres.

The **tread depth** of new tyres may *vary*, according to the type and make of tyre and the tread pattern.

Concealed damage

Damage to tyres and rims is often not readily visible. If you notice unusual **vibration** or the car **pulling to one side**, this may indicate that one of the tyres is damaged. Reduce speed immediately if there is any reason to suspect that damage may have occurred. Inspect the tyres for damage. If no external damage is visible, drive slowly and carefully to the nearest specialised workshop and have the car inspected.

Tyres with directional tread pattern

An arrow on the tyre sidewall indicates the direction of rotation on single drive tyres. Always note the direction of rotation indicated when mounting the wheel. This guarantees optimum grip and helps to avoid aquaplaning, excessive noise and wear.

Retrofitting Accessories

If you wish to change or fit wheels, rims or wheel trims, we recommend that you consult with a SEAT Official Service centre for advice regarding current techniques. ■

Useful life of tyres

Correct inflation pressures and sensible driving habits will increase the useful life of your tyres.

- Check tyre pressure at least once a month, and also prior to any long trip. ▶

- The tyre pressure should only be checked when the tyres are *cold*. The slightly raised pressures of warm tyres must not be reduced.
- Adjust tyre pressure to the load being carried by the vehicle.
- In vehicles with a tyre pressure indicator, save the pressure of modified tyres ⇒ page 175, ⇒ page 223.
- Avoid fast cornering and hard acceleration.
- Inspect the tyres for irregular wear from time to time.

The useful life of your tyres depends on the following factors:

Tyre pressure

Tyre pressure values are indicated on the inside of the fuel tank flap.

Insufficient or excessive pressure greatly reduces the useful life of the tyres and adversely affects vehicle performance and ride. Correct inflation pressures are very important, especially at **high speeds**.

If you want a more comfortable ride, you can inflate tyres to the pressure corresponding to the normal vehicle load (up to 3 people) if the vehicle is carrying a normal load. If the vehicle is going to carry the maximum load, the tyre pressure should be increased to maximum value indicated.

The tyre pressure must be adjusted according to the load the vehicle is carrying. We recommend adhering to the tyre pressure specifications for a maximum load.

Do not forget the spare wheel when checking the tyre pressures: Keep the spare wheel inflated to the highest pressure required for the road wheels.

In the case of a minimised temporary spare wheel (125/70 R16 or 125/70 R18) inflate to a pressure of 4.2 bar as indicated on the tyre pressure label on the fuel tank flap.

Driving style

Fast cornering, heavy acceleration and hard braking (squealing tyres) all increase tyre wear.

Wheel balance

The wheels on new vehicles are balanced. However, certain circumstances may lead to imbalance (run-out), which is detected as vibrations in the steering wheel.

Unbalanced wheels should be rebalanced, as they otherwise cause excessive wear on steering, suspension and tyres. A wheel must also be rebalanced when a new tyre is fitted or if a tyre is repaired.

Incorrect wheel alignment

Incorrect wheel alignment causes excessive tyre wear, impairing the safety of the vehicle. If you notice excessive tyre wear, you should check wheel alignment at a SEAT Official Service.



WARNING

- Always adapt the tyre pressure accordingly when the vehicle load changes.
- A tyre with low air pressure has to flex a lot more when the vehicle is heavily loaded or at high speeds, therefore causing overheating to occur. Under these conditions, the tyre bead may be released or the tyre may burst. Risk of accident!



For the sake of the environment

Under-inflated tyres will increase fuel consumption. ■

Indications of wear

Tread wear indicators indicate if a tyre is worn.



Fig. 115 Tyre tread:
tread wear indicators

The original tyres on your vehicle have 1.6 mm high “tread wear indicators” running across the tread. Depending on the manufacturer, there will be 6 to 8 of them spaced at equal distances around the tyre. Markings on the tyre sidewall (for instance the letters “TWI” or a triangle) indicate the positions of the tread wear indicators.

The minimum tread depth required by law is 1.6 mm (measured in the tread grooves next to the tread wear indicators). (Different figures may apply in other countries.)

WARNING

The tyres must be replaced at the latest when the tread is worn down to the tread wear indicators. Failure to do so could result in an accident.

- Especially in difficult driving conditions such as wet or icy roads, it is important that the tyres have sufficient tread depth. The tread depth should be the same on the tyres of both the front and the rear axles.
- The decrease in driving safety due to insufficient tread depth is particularly evident in vehicle handling, when there is a risk of aquaplaning in deep puddles of water and when driving through corners. Braking is also adversely affected.
- The speed has to be adapted accordingly, otherwise there is a risk of losing control over the vehicle.

Changing wheels

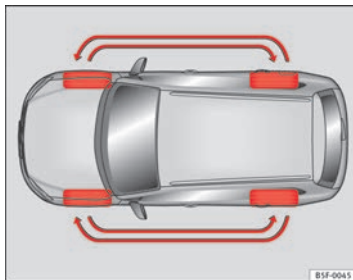



Fig. 116 Changing
wheels around

To ensure that the wear is equal on all tyres the wheels should be changed round from time to time according to the system ⇒ Fig. 116. The useful life of all the tyres will then be about the same time.

Replacing wheels and tyres

It is important to use the correct wheels and tyres when replacement is necessary.

- All four wheels must be fitted with tyres of the same type, size (rolling circumference) and preferably the same tread pattern.
- Tyres should be replaced at least in pairs and not individually (i.e. both front tyres or both rear tyres together).
- Do not use tyres whose effective size exceeds the dimensions of the factory-approved makes of tyre.
- If you wish to fit the vehicle with rims or tyres that are different to those installed in manufacture, it is advisable to consult a SEAT Official Service **before** purchasing them.

The tyres and wheel rims are an essential part of the vehicle's design. The tyres and rims approved by SEAT are specially matched to the characteristics of the vehicle and make a major contribution to good roadholding and safe handling ⇒ .

The sizes of the rims and tyres approved for your vehicle are listed in the vehicle documentation (e.g. EC Certificate of Conformity or COC document¹⁾). The vehicle documentation varies depending on the country of residence.

¹⁾ COC = certificate of conformity

A knowledge of tyre designations makes it easier to choose the correct tyres. The following wording can be read on the sides of the tyre:

205/55 R 16 91 W

This contains the following information:

205	Tyre width in mm
55	Height/width ratio in %
R	Tyre construction: R adial
16	Rim diameter in inches
91	Load rating code
W	Speed index

The **manufacturing date** is also indicated on the tyre sidewall (possibly only on the *inner* side of the wheel):

DOT ... 2212 ...

means that the tyre was produced in the 22nd week of 2012.

Please note that with some types of tyre, the actual tyre size can differ from the nominal size marked on the tyre (for instance 205/55 R 16 91 W), and there may be significant differences in the contours of the tyres, even though the tyres are marked with the same nominal size designation. When replacing the tyres, it is therefore important to make sure that the actual size of the new tyres does not exceed the dimensions of the factory-approved makes of tyre.

Failure to observe this requirement can affect the clearance needed for the tyres. This could result in contact between the tyres and suspension components or bodywork causing damage. The brake lines could also be damaged and vehicle safety could be severely impaired ⇒ .

If you use tyres that are approved by SEAT you can be sure that the actual tyre dimensions will be correct for your vehicle. If you decide to fit a different type of tyre, you must obtain the appropriate manufacturer's certificate from the tyre retailer to confirm that the tyres are suitable for your vehicle. Keep this certificate in a safe place.

Your SEAT Official Service will be able to advise you on which tyres may be fitted to your vehicle.

It is best to have all servicing of wheels and tyres performed by a **specialised workshop**. They are familiar with the procedure and have the necessary special tools and spare parts as well as the proper facilities for disposing of the old tyres.



WARNING

- It is very important to ensure that the tyres you have chosen have adequate clearance. When selecting replacement tyres, do not rely entirely on the nominal tyre size marked on the tyre; with some makes of tyre the effective tyre size can differ significantly from the nominal dimensions, even though the tyres have the same size designation. Inadequate tyre clearance can result in damage to the tyres or the vehicle, causing a serious safety risk. It may also invalidate the vehicle's registration for use on public roads.
- Avoid running the vehicle on tyres that are more than 6 years old. If you have no alternative, you should drive slowly and with extra care at all times.
- If wheel trims are fitted after the car is purchased, ensure that there is an adequate flow of air for cooling the brake system.



For the sake of the environment

Old tyres must be disposed of according to the laws in the country concerned.



Note

- Never mount used tyres if you are not sure of their "previous history".
- For technical reasons, it is not generally possible to use the wheels from other vehicles. In some cases, this may also be true for the same model of wheel.

Wheel bolts

The wheel bolts are designed to suit the rims on your car.

The **wheel bolts** are matched to the rims. When installing different wheels (for instance alloy wheels or wheels with winter tyres) it is important to use the correct wheel bolts with the right length and correctly shaped bolt heads. This ensures that wheels are fitted securely and that the brake system functions correctly.

The wheel bolts must be clean and turn easily.

A special adapter is required to turn the anti-theft wheel bolts*
⇒ page 237.

Winter tyres

Winter tyres will improve the vehicles handling on snow and ice.

- Winter tyres must be fitted **on all four** wheels.
- Only use winter tyres that are approved for your vehicle.
- Please note that the maximum permissible speed for winter tyres may be lower than for summer tyres.

- Also note that winter tyres are no longer effective when the **tread** is worn down.
- After fitting the wheels you must always check the tyre pressures. The correct tyre pressures are listed on the sticker on the inside of the fuel tank flap → page 223.

In winter road conditions winter tyres will considerably improve vehicle handling. The design of summer tyres (width, rubber compound, tread pattern) gives less grip on ice and snow. This applies particularly to vehicles equipped with **wide section tyres** or **high speed tyres** (code letters H, V or Y on the sidewall).

Only use winter tyres of the correct type approved for your vehicle. The sizes of the winter tyres approved for your vehicle are listed in the vehicle documentation (e.g. EC Certificate of Conformity or COC document ¹⁾). The vehicle documentation varies depending on the country of residence. See also → page 226.

Winter tyres lose a great deal of their properties when the **tread** is worn down to a depth of 4 mm.

The performance of winter tyres is also severely impaired by **ageing**, even if the tread is still much deeper than 4 mm.

Winter tyres are subject to the following **maximum speed limits** according to speed rating code letter: ⇒ ⚠

Speed rating code letter ⇒ page 226	Maximum speed limit
Q	160 km/h (140 mph)
S	180 km/h (140 mph)
T	190 km/h (140 mph)

¹⁾ COC = certificate of conformity

Speed rating code letter ⇒ page 226	Maximum speed limit
H	210 km/h (140 mph)
V	240 km/h (150 mph) (note restrictions)

Vehicles capable of exceeding these speeds must have an appropriate **sticker** attached so that it is visible to the driver. Suitable stickers are available from the SEAT Official Service and specialised workshop. Please note regulations to this effect in your country.

“All-weather” tyres can also be used instead of winter tyres.

Using winter tyres with V-rating

Please note that the generally applicable 240 km/h (150 mph) speed rating for winter tyres with the letter V is subject to **technical restrictions; the maximum permissible speed for your vehicle may be significantly lower**. The maximum speed limit for tyres with a V-rating depends directly on the maximum axle weights for your car and on the listed weight rating of the tyres being used.

It is best to contact a SEAT Official Service to check the maximum speed which is permissible for the V-rated tyres fitted on your car on the basis of this information.

WARNING

Exceeding the maximum speed permitted for the winter tyres fitted on your car can cause tyre failure, resulting in a loss of control of the vehicle – risk of accident. ▶



For the sake of the environment

Summer tyres should be fitted again as soon as possible; they give better handling on roads which are free of snow and ice. Summer tyres perform with less rolling noise, tyre wear and – most important – reduce fuel consumption.

Snow chains

Snow chains will improve vehicle handling on snow-covered roads.

- Snow chains can be used on the *front* wheels only.
- Check that the snow chains are correctly seated after driving for a few yards. Always take the manufacturer assembly instructions into account.
- Keep your speed below 50 km/h (30 mph).
- If there is a danger of being trapped despite having mounted the chains, it is best to disable the driving wheels (ASR) in the ESC → page 184, Switching on/off the ESC and ASR.

Snow chains will improve *braking ability* as well as *traction* in winter conditions.

For technical reasons snow chains may only be used with the following wheel rim/tyre combination.

195/65 R15	Chains with links of maximum 15 mm
205/55 R16	Chains with links of maximum 15 mm
225/45 R17	Chains with links of maximum 9 mm
225/40 R18	Chains with links of maximum 9 mm

Only use snow chains with **fine-pitch links**. The links must not protrude more than 13.5 mm from the tyres (including tensioner).

Remove **wheel covers** and trim rings before fitting snow chains.

Remove the chains when roads are *free of snow*. Otherwise they will impair handling, damage the tyres and wear out very quickly.

Accessories and modifications to the vehicle

Accessories, replacement parts and repairs

Always ask your dealer or specialist retailer for advice before purchasing accessories and replacement parts.

Your vehicle is designed to offer a high standard of active and passive safety. For this reason, we recommend that you ask a SEAT Official Service for advice before fitting accessories or replacement parts. Your SEAT Official Service has the latest information from the manufacturer and can recommend accessories and replacement parts which are suitable for your requirements. They can also answer any questions you might have regarding official regulations.

We recommend you to use only **SEAT accessories** and **Genuine SEAT parts**[®]. SEAT has tested these parts and accessories for suitability, reliability and safety. SEAT Official Services have the necessary experience and facilities to ensure that the parts are installed correctly and professionally.

Any **retro-fitted equipment** which has a direct effect on the vehicle and/or the way it is driven (e.g. cruise control system or electronically-controlled suspension) must be approved for use in your vehicle and bear the **e** mark (the European Union's authorisation symbol).

If any **additional electrical components** are fitted which do not serve to control the vehicle itself (for instance a refrigerator box, laptop or ventilator fan, etc.), these must bear the **C** mark (manufacturer conformity declaration in the European Union).



WARNING

Accessories, for example telephone holders or cup holders, should never be fitted on the covers, or within the working range of the airbags. Otherwise, there is a danger of injury if the airbag is triggered in an accident.

Technical modifications

Modifications must always be carried out according to our specifications.

Unauthorised modifications to the electronic components, software, wiring or data transfer in the vehicle may cause malfunctioning. Due to the way the electronic components are linked together in networks, other indirect systems may be affected by the faults. This can seriously impair safety, lead to excessive wear of components, and also invalidate your vehicle registration documents.

You will appreciate that your SEAT dealership cannot be held liable for any damage caused by modifications and/or work performed incorrectly.

We recommend that all work should be performed by a SEAT Official Service using **Genuine SEAT parts**[®].



WARNING

Incorrectly performed modifications or other work on your vehicle can lead to malfunctions and cause accidents.

Radio transmitters and business equipment

Radio transmitters (fixed installation)

Any retrofit installations of radio transmitters in the vehicle require prior approval. SEAT generally authorises in-vehicle installations of approved types of radio transmitters provided that:

- the aerial is installed correctly.
- the aerial is installed on the exterior of the vehicle (and shielded cables are used together with non-reflective aerial trimming).
- the effective transmitting power does not exceed 10 Watts at the aerial base.

A SEAT Official Service and specialised workshop will be able to inform you about options for installing and operating radio transmitters with a *higher* transmitting power.

Mobile radio transmitters

Commercial mobile telephones or radio equipment might interfere with the electronics of your vehicle and cause malfunctions. This may be due to:

- no external aerial
- external aerial incorrectly installed
- transmitting power more than 10 W

You must, therefore, do not operate portable mobile telephones or radio equipment *inside the vehicle* without a properly installed external aerial ⇒ ⚠.

Please note also that the maximum range of the equipment can only be achieved with an *external* aerial.

Business equipment

Retrofit installation of business or private equipment in the vehicle is permitted, provided the equipment cannot interfere with the driver's immediate control of the vehicle and that any such equipment carries the CE mark. Any retrofit equipment that could influence the driver's control of the vehicle must have a type approval for your vehicle and must carry the e mark.



WARNING

Mobile telephones or radio equipment which is operated inside the vehicle without a properly installed external aerial can create excessive magnetic fields that could cause a health hazard.



Note

- The posterior fitting of electric and electronic equipment in this vehicle affects its licence type and could lead to the withdrawal of the vehicle registration document under certain circumstances.
- Please use the mobile telephone/radio operating instructions. ■

Emergencies

General information

- If you have a flat tyre or puncture, park the car as far away from the flow of traffic as possible in a safe place. If you have a puncture, stop the vehicle on a horizontal surface. If you are on a slope, take extra care.
- Apply the handbrake.
- Switch on the hazard warning lights.
- Always wear a reflective vest ⇒ page 232.
- Set up the warning triangle.
- All vehicle occupants should leave the car. They should wait in a safe place (for instance behind the roadside crash barrier).



WARNING

Always observe the above steps and protect yourself and other road users.

Equipment

Reflective vests

Wearing a reflective vest makes you more visible to other road users.



Note

- Always wear a reflective vest when you get out of the vehicle in moving traffic (for example, in the event of breakdown or to load/unload the vehicle).
- Observe the applicable legislation for each country. ■

Vehicle tools/Tyre repair kit/Compressor*

The vehicle tools, the tyre repair kit and the compressor* are stored under the floor panel in the luggage compartment.

To access the vehicle tools:

- Lift up the floor panel by the plastic handle until it is fastened to the tabs on both sides.

Depending on the vehicle equipment, you will find the tyre repair set and the compressor* under the floor panel cover. ■

Tyre repair kit

What to do first

- Please observe the important safety notes ⇒ page 232.
- Apply the handbrake.
- Manual gearbox: Select first gear.
- Automatic gearbox: Move the selector lever to P.
- Check whether a repair is possible using the tyre repair kit ⇒ page 233.

Using the tyre repair kit



Fig. 117 Tyre: irreparable damage

The tyre repair kit is designed to repair your tyre provisionally only. The damaged tyre should be replaced as soon as possible ⇒ **⚠**.

If the tyre has been damaged by a nail, for example, remove the nail from the tyre.

The tyre repair kit can be used at outside temperatures of up to -20 °C (-4 °F).

The tyre repair kit must NOT be used:

- on cuts and punctures larger than 4 mm **①** ⇒ Fig. 117
- If the wheel rim has been damaged **②**
- if you have been driving with very low pressure or a completely flat tyre **③**.

If necessary, request assistance from specialised personnel.

⚠ WARNING

- Remember that the tyre repair kit cannot always be used, and that it only serves to provide a provisional repair.
- Do not allow the sealing product to come into contact with your eyes, skin or clothing.
- If you do come into contact with the sealing product immediately rinse the eyes or skin affected with clean water.
- Do not inhale vapours.
- If any of the sealing product is accidentally ingested, immediately rinse the mouth thoroughly and drink lots of water. Do not induce vomiting. Seek medical advice immediately.
- Change clothing immediately if it becomes soiled with the sealing product.
- If any allergic reactions should occur get medical help immediately.
- Keep the sealing product away from children.

**Note**

- If sealing product should leak out, leave it to dry. This way you can pull it off like a piece of foil.
- Observe the expiry date stated on the sealing compound can. Have the sealing compound changed by a specialised workshop or SEAT Service.
- Please observe legal requirements when doing so. ■

Repairing tyres

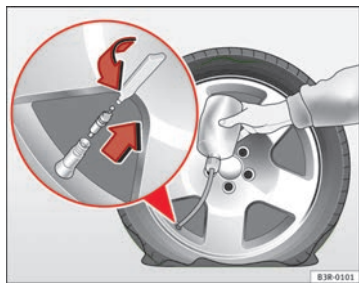

Fig. 118 Tyre: top up

Important: have the tyre repair kit ready ⇒ page 232.

Filling the tyre

- Before filling the tyre, shake the bottle of sealing product thoroughly.
 - Screw the enclosed filling hose onto the sealant can as far as it will go. This will pierce the foil sealing on the can.
- Take the valve cap off the tyre valve and use a screwdriver ⇒ Fig. 118 to unscrew the valve insert.
 - Place the valve insert onto a clean surface.
 - Remove the sealing plug from the filling hose and insert the hose into the tyre valve.
 - Hold the bottle upside down and insert the contents in the tyre until the bottle is empty.
 - Then disconnect the hose and screw the valve insert back onto the tyre valve.

Inflating the tyre

- Screw the compressor filling hose (tyre repair kit) onto the tyre valve and plug the connector into the 12V connection.
- Pump the tyre up to 2.0 to 2.5 bar and monitor the pressure shown on the pressure gauge.
- If the tyre does not reach this pressure, move the car forwards or backwards 10 metres to allow the sealing compound to spread all around the tyre.

**WARNING**

- Please observe the manufacturer's safety notes on the compressor and the instructions supplied with the tyre sealant can.
- If, after six minutes of trying to inflate the tyre, it is not possible get up to a pressure of 2.0 bar, this indicates that the tyre is too severely damaged for repair with the kit. Do not carry on driving!
- If the tyre cannot be repaired with the sealing compound, seek professional assistance. ▶

**Note**

Do not use the compressor for longer than 6 minutes at a time, as it could overheat. Once it has cooled down, the compressor may be used again. ■

After changing a wheel

- Attach the "max. 80 km/h (50 mph)" adhesive label from the tyre repair kit on the instrument panel, clearly within view of the driver.
- Stop the vehicle after 10 minutes driving and check the tyre pressure.
- If tyre pressure is less than 1.3 bar, the tyre is too badly damaged. Do not carry on driving!

**WARNING**

After repairing a tyre please note the following points:

- Do not drive faster than 80 km/h (50 mph).
- Avoid heavy acceleration, hard braking and fast cornering.
- Vehicle handling could be impaired.
- If the tyre is very damaged, seek professional assistance.

**For the sake of the environment**

You can dispose of the used bottle of sealing compound at a SEAT Official Service.

**Note**

After repairing a tyre, remember to purchase a new bottle of sealing compound from a SEAT Official Service or a specialised workshop. ■

Changing a wheel

What to do first

Before changing the wheel, the following preliminary steps are required.

- Please observe the important safety notes ⇒ page 232.
- Apply the handbrake.
- Manual gearbox: Select first gear.
- Automatic gearbox: Move the selector lever to P.
- When towing a trailer: Unhitch the trailer from your vehicle.
- Have the vehicle tool kit ⇒ page 232 and the spare wheel ready ⇒ page 240.

**WARNING**

If you change the wheel on a slope, block the wheel on the opposite side of the car with a stone or similar to prevent the vehicle from moving. ■

Wheel covers*

The wheel covers must be removed for access to the wheel bolts

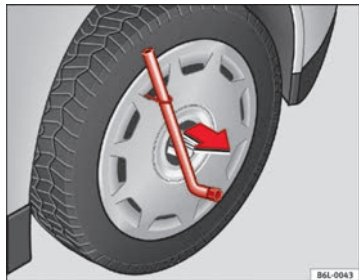

Fig. 119 Remove the complete hub cap

Removing

- Remove the wheel cover using the wire hook ⇒ Fig. 119.
- Hook this into one of the cut-outs of the wheel cover.

Fitting

- Fit the wheel cover onto the wheel rim by pressing it firmly. Put pressure initially on the point of the cut-out for the valve. Next fit the rest of the hubcap

Removing the wheel bolt caps*

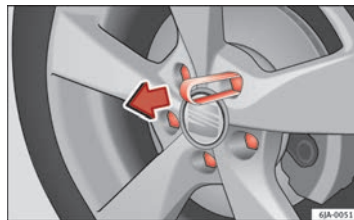

Fig. 120 Wheel: wheel bolts with caps

Removal

- Fit the plastic clip (vehicle tools) over the cap until it clicks into place ⇒ Fig. 120.
- Remove the cap with the plastic clip.

Anti-theft wheel bolts

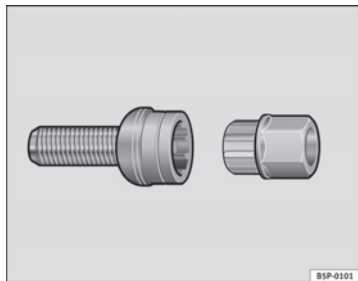

Fig. 121 Anti-theft wheel bolt with cap and adapter

A special adapter (vehicle tools) is required to remove the anti-theft wheel bolts.

- Remove the wheel cover* or the cap*.
- Insert the adapter onto the anti-theft wheel bolt and push it on as far as it will go.
- Insert the wheel brace (vehicle tools) onto the adapter as far as it will go.
- Remove the wheel bolt ⇒ page 237.

¹⁾ An adapter is required to unscrew or tighten the anti-theft wheel bolts ⇒ page 237.

Note

Make a note of the code number of the anti-theft wheel bolt and keep it in a safe place, but not in your vehicle. If you need a new adapter, you can obtain it from the SEAT Official Service, indicating the code number. ■

Loosening the wheel bolts



Fig. 122 Wheel: loosen the wheel bolts

- Insert the wheel brace (vehicle tools) onto the wheel bolt as far as it will go¹⁾.
- Turn the wheel bolt approximately one turn to the left ⇒ Fig. 122 -arrow-. To apply the required torque, hold the wheel brace at the end. If it is not possible to loosen a wheel bolt, carefully apply pressure with one foot on the end of the wheel brace. Hold on to the car for support and take care not to slip. ►

**WARNING**

Slightly loosen the wheel bolts (one turn) before raising the vehicle with the jack*. If not, an accident may occur.

Raising the vehicle



Fig. 123 Crossbar: makes

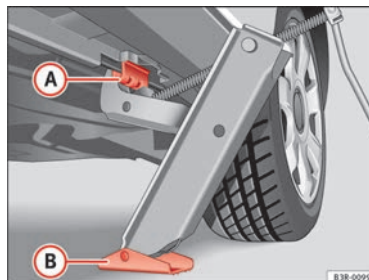

Fig. 124 Strut: mounting the jack on the vehicle

- Place the jack* (vehicle tools) on a firm surface. If necessary use a large, strong board or similar support. If the surface is slippery (for example, tiles), use a non-slip base underneath the jack (for example, a rubber mat) ⇒ .
- Find the support point on the strut (sunken area) closest to the wheel to be changed ⇒ Fig. 123. The jack* support point is behind the mark on the strut.
- Turn the jack*, located below the strut support point, to raise it until tab ⇒ Fig. 124 is below the plastic housing.
- Align the jack* so that tab "grips" onto the plastic housing on the strut and the mobile base plate is resting on the ground. The base plate should fall vertically with respect to the support point .
- Continue turning the jack* until the wheel is slightly lifted off the ground. ▶

 **WARNING**

- Make sure that the jack* remains stable. If the surface is slippery or soft, the jack* could slip or sink, respectively, with the resultant risk of injury.
- Only raise the vehicle with the jack* supplied by the manufacturer. Other vehicles could slip, with the consequent risk of injury.
- Only mount the jack* on the support points designed for this purpose on the strut, and always align the jack correctly. If you do not, the jack* could slip as it does not have an adequate grip on the vehicle: risk of injury!
- The height of the parked vehicle can change as a result of variations in temperature and loading.

 **CAUTION**

The vehicle must not be raised on the crossbar. Only place the jack* on the points designed for this purpose on the strut. Otherwise, the vehicle may be damaged.

Removing and fitting a wheel

After loosening the wheel bolts and raising the vehicle with the jack, change the wheel as described below:

Taking off the wheel

- Unscrew the wheel bolts using the box spanner and place them on a clean surface.
- Take off the wheel ⇒ ⑩.

Putting on the spare wheel

When fitting tyres with a compulsory rotation direction, observe the instructions in ⇒ page 239.

- Mount the wheel.
- Screw on the wheel bolts in position and tighten them loosely with a box spanner.
- Carefully lower the vehicle using the jack*.
- Tighten the wheel bolts in diagonal pairs using the wheel brace.

The wheel bolts should be clean and turn easily. Before fitting the spare wheel, inspect the wheel condition and hub mounting surfaces. These surfaces must be clean before fitting the wheel.

 **CAUTION**

When removing/fitting the wheel, the rim may hit and damage the brake disc. For this reason, please take care and get a second person to assist you.

Tyres with compulsory direction of rotation

A directional tread pattern can be identified by arrows on the sidewall that point in the direction of rotation. Always observe the direction of rotation indicated when mounting the wheel. This is important so that these tyres can give maximum grip and avoid excessive noise, tread wear and aquaplaning.

If, exceptionally, it is necessary to mount the spare wheel* in the opposite direction of rotation, please drive carefully, as in this case the tyre does not have optimum conditions of use. This is particularly important when driving on wet roads. ▶

To benefit from the advantages of tyres with this type of tread pattern, the defective tyre should be replaced as soon as possible so that all tyres again rotate in the correct direction.

After changing a wheel

- On alloy wheels: replace the wheel bolt caps.
- On plate wheels: replace the wheel hubcap ⇒ page 236.
- Put the tools and jack back in the luggage compartment.
- If the replaced wheel does not fit in the spare wheel housing, store it safely in the luggage compartment ⇒ page 17.
- Check the tyre pressure of the newly mounted tyre as soon as possible.
- In vehicles fitted with a tyre pressure indicator, adjust the pressure and store the reading in the radio/Easy Connect system* ⇒ page 175.
- The wheel bolts should be tightened to 120 Nm. Check the torque as soon as possible with a torque wrench. Meanwhile, drive carefully.
- Have the flat tyre replaced as quickly as possible.

Spare wheel

General information



Fig. 125 Compact temporary spare wheel: raised floor panel

The temporary spare wheel has been designed to be used for short periods of time. Have the tyres checked, and if necessary, replaced as soon as possible at a SEAT Official Service or at a specialised workshop.

Please note the following restrictions when using the compact temporary spare wheel. The compact temporary spare wheel is designed specifically for this model. For this reason, do not use a temporary spare wheel from a different type of vehicle.

Removing the temporary spare wheel

- Lift and hold up the floor panel to remove the temporary spare wheel ⇒ Fig. 125.
- Turn the thumb wheel anti-clockwise.

- Take out the temporary spare wheel.

Chains

For technical reasons, snow chains must not be used on the temporary spare wheel.

If you have a puncture on one of the front wheels when using snow chains, fit the temporary spare wheel in place of one of the rear wheels. Fit the snow chains on the rear wheel that you have removed and replace the punctured front wheel with this wheel.

WARNING

- After fitting the temporary spare wheel, check the tyre pressures as soon as possible. Failure to do so may cause an accident. The tyre pressures are listed on the inside of the fuel tank flap.
- Do not drive at over 80 km/h (50 mph) when the temporary spare wheel is fitted on the vehicle: risk of accident!
- Avoid heavy acceleration, hard braking and fast cornering: risk of accident!
- Never use more than one temporary spare wheel at the same time, risk of accident.
- No other type of tyre (normal summer or winter tyre) may be fitted on the compact temporary spare wheel rim.

Jump starting

Jump leads

The jump lead must have a sufficient wire cross section.

If the engine fails to start because of a discharged battery, the battery can be connected to the battery of another vehicle to start the engine.

Jump leads

Jump leads must comply with standard **DIN 72553** (see cable manufacturer's instructions). The wire cross section must be at least 25 mm² for petrol engines and at least 35 mm² for diesel engines.



Note

- The vehicles must not touch each other, otherwise electricity could flow as soon as the positive terminals are connected.
- The discharged battery must be properly connected to the on-board network.

How to jump start: description

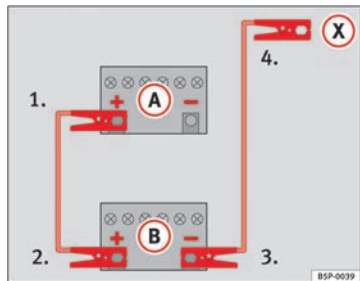

Fig. 126 Diagram of connections for vehicles without Start Stop system

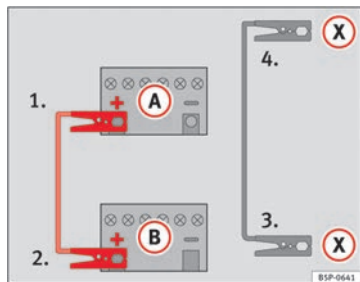

Fig. 127 Diagram of connections for vehicles with Start Stop system

Jump lead terminal connections

1. Switch off the ignition of both vehicles ⇒ ⚠.
2. **For vehicles without Start-Stop system:**

- Connect one end of the *red* jump lead to the positive (+) terminal of the vehicle with the flat battery (A) ⇒ Fig. 126.
- Connect the other end of the *red* jump lead to the positive terminal (+) in the vehicle providing assistance (B).
- Connect one end of the *black* jump lead to the negative terminal (-) of the vehicle providing assistance (B) ⇒ Fig. 126.
- Connect the other end of the *black* jump lead (X) to a solid metal component bolted to the engine block or to the engine block itself of the vehicle with the flat battery. However, connect it to a point as far as possible from the battery (A).

3. For vehicles with Start-Stop system:

- Connect one end of the *red* jump lead to the positive (+) terminal of the vehicle with the flat battery (A) ⇒ Fig. 127.
- Connect the other end of the *red* jump lead to the positive terminal (+) in the vehicle providing assistance (B).
- Connect one end of the *black* jump lead (X) to a suitable ground terminal, a solid piece of metal in the engine block, or to the engine block ⇒ Fig. 127.
- Connect the other end of the *black* jump lead (X) to a solid metal component bolted to the engine block or to the engine block itself of the vehicle with the flat battery. However, connect it to a point as far as possible from the battery (A).

4. Position the leads in such a way that they cannot come into contact with any moving parts in the engine compartment. ▶

Starting

- Start the engine of the vehicle with the boosting battery and let it run at idling speed.
- Start the engine of the vehicle with the flat battery and wait two or three minutes until the engine is "running".

Removing the jump leads

- Before you remove the jump leads, switch off the dipped beam headlights (if they are switched on).
- Turn on the heater blower and heated rear window in the vehicle with the flat battery. This helps minimise voltage peaks which are generated when the leads are disconnected.
- When the engine is running, disconnect the leads in reverse order to the details given above.

Connect the battery clamps so they have good metal-to-metal contact with the battery terminals.

If the engine fails to start, switch off the starter after about 10 seconds and try again after about half a minute.

WARNING

- Please note the safety warnings referring to working in the engine compartment → page 209.
- The battery providing assistance must have the same voltage as the flat battery (12V) and approximately the same capacity (see imprint on battery). Failure to comply could result in an explosion.

WARNING (Continued)

- Never use jump leads when one of the batteries is frozen. Danger of explosion! Even after the battery has thawed, battery acid could leak and cause chemical burns. If a battery freezes, it should be replaced.
- Keep sparks, flames and lighted cigarettes away from batteries, danger of explosion. Failure to comply could result in an explosion.
- Observe the instructions provided by the manufacturer of the jump leads.
- Do not connect the negative cable from the other vehicle directly to the negative terminal of the flat battery. The gas emitted from the battery could be ignited by sparks. Danger of explosion.
- Do not attach the negative cable from the other vehicle to parts of the fuel system or to the brake line.
- The non-insulated parts of the battery clamps must not be allowed to touch. The jump lead attached to the positive battery terminal must not touch metal parts of the vehicle, this can cause a short circuit.
- Position the leads in such a way that they cannot come into contact with any moving parts in the engine compartment.
- Do not lean on the batteries. This could result in chemical burns.

Note

The vehicles must not touch each other, otherwise electricity could flow as soon as the positive terminals are connected. ■

Towing and tow-starting the vehicle

General information

Points to observe when tow-starting or towing away

If you use a tow rope:

Notes for the driver of the towing vehicle

- The tow rope must be taut before you drive off.
- Release the clutch very carefully when starting the vehicle (manual gearbox), or accelerate gently (automatic gearbox).

Notes for the driver of the towed vehicle

- The ignition should be switched on so that the turn signals, horn, windscreen wipers and washers can be used. Please ensure that the steering wheel is unlocked when you switch on the ignition, and that it moves freely.
- Put the gearbox lever in neutral (manual gearbox) or move the selector lever to position N (automatic gearbox).
- The brake servo only works when the engine is running. Considerably more effort is required on the brake pedal when the engine is switched off.
- Remember that the brake servo only works when the ignition is switched on and the vehicle is moving¹⁾. Otherwise, considerably more strength than usual will be required when steering.

¹⁾ Important: the battery must be correctly charged.

- Ensure that the tow rope remains taut at all times.

Tow rope or tow bar

It is easier and safer to tow a vehicle with a tow *bar*. You should only use a *tow rope* if you do not have a tow bar.

A tow rope should be slightly elastic to avoid damage to both vehicles. It is advisable to use a tow rope made of synthetic fibre or similarly elastic material.

Only attach the tow rope or the tow bar to the towing rings → page 245.

Driving style

Towing requires some experience, especially when using a tow *rope*. Both drivers should be familiar with the technique required for towing. Inexperienced drivers should not attempt to tow.

Do not pull too hard with the towing vehicle and take care to avoid jerking the tow rope. When towing on an unpaved road, there is always a risk of overloading and damaging the anchorage points.



WARNING

If the vehicle has no electrical power, the brake lights, turn signals and all other lights will no longer function. Do not have the vehicle towed away. Failure to do so could result in an accident.



CAUTION

If there is no oil in the gearbox or no lubricant in the automatic transmission the car may only be towed with the driven wheels lifted clear of the road, or transported on a special car transporter or trailer. ▶

**Note**

- Please observe legal requirements when doing so.
- Switch on the hazard warning lights of both vehicles. However, observe any regulations to the contrary.
- The tow rope must not be twisted. Otherwise the front towline anchorage could be pulled off the vehicle.

Towline anchorage at the front of the vehicle

The front towline anchorage is only mounted if the vehicle has to be towed.

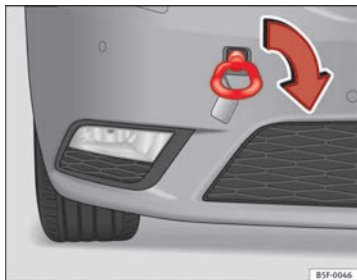

Fig. 128 Right side of the front bumper: towline anchorage screwed in

There is a cover with an opening into which the towline anchorage is screwed on the right part of the front bumper.

- To remove the bumper cover, just press the *upper left* side inwards.
- Take the towline anchorage out of the vehicle tool kit ⇒ page 232.
- Screw the towline anchorage into the screw connection as far as it will go ⇒ **Fig. 128** and tighten with the wheel brace.
- After use, unscrew the towline anchorage and fit the cover back on the bumper. Put the towline anchorage back in the vehicle tool kit. The towline anchorage should always be kept in the vehicle. ■

Rear towline anchorage

The rear towline anchorage should only be mounted if you wish to tow another vehicle.

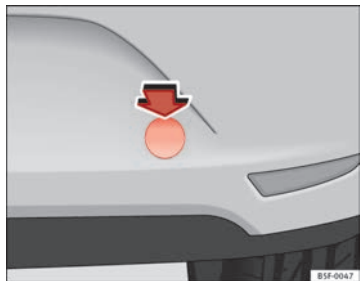

Fig. 129 Right side of the rear bumper: cover cap



Fig. 130 Right side of the rear bumper: towline anchorage screwed in

Vehicles with towline anchorage

On the right of the rear bumper there is a cover which covers a threaded hole.

- Take the towline anchorage out of the vehicle tool set
⇒ page 232.
- To remove the bumper cover, press the *upper* side of the cover inwards -arrow- and remove the cover by levering on the *left* side ⇒ Fig. 129.
- Screw the towline anchorage into the screw connection as far as it will go ⇒ Fig. 130 and tighten with the wheel brace.

After use, unscrew the towline anchorage and put it back in the vehicle tool kit. Replace the cover on the bumper. The towline anchorage should always be kept in the vehicle.



WARNING

- If the towline anchorage is not screwed in as far as the stop, there is a risk of the screw connection shearing off during towing (accident risk).
- If your car has a towing bracket, only use special towing ropes. Risk of accident!



CAUTION

In vehicles fitted with a towing bracket, only use special tow bars to prevent damage to the ball joint. These tow bars have been specially approved for use with towing brackets.



Note

If the vehicle is fitted with a towing hook, the ball must be fitted in it when towing the vehicle.

Tow-starting

As a general rule, tow-starting is not recommended.

- Engage 2nd or 3rd gear before moving off.
- Press the clutch and hold the pedal down.
- Switch the ignition on.
- Once both vehicles are moving, release the clutch.
- As soon as the engine starts: press the clutch and put the gear lever in neutral.

If the engine will not start, it is best to try starting it using the battery of another vehicle ⇒ page 241 before attempting to tow start. You should only try to tow-start the engine if jump starting is not successful. Tow-starting is an attempt to start the engine via the movement of the wheels.

When tow-starting a vehicle with a **petrol engine**, do not tow it more than a *short* distance, otherwise sunburnt fuel can enter the catalytic converter and cause damage.



WARNING

The risk of accidents is high when tow-starting, as the towed vehicle can easily be driven into the towing vehicle.



CAUTION

Do not tow vehicles for more than 50 m. Risk of damage to the catalytic converter.

Towing vehicles with a manual gearbox

Towing is relatively straightforward.

Please observe the relevant instructions ⇒ page 244.

The vehicle can be towed using a tow bar or tow rope in the normal way, with all four wheels on the road; it can also be towed with either the front or rear wheels lifted off the road. The maximum towing speed is **50 km/h (30 mph)**.

Towing a vehicle equipped with automatic gearbox

Certain restrictions must be observed when towing your vehicle.

Please observe the relevant instructions ⇒ page 244.

The vehicle can be towed with a tow bar or tow rope in the normal way, with all four wheels on the ground. When doing so, please note the following points:

- Make sure the **selector lever is in the N** position.
- The vehicle must not be towed faster than **50 km/h (30 mph)**.
- The vehicle must not be towed further than **50 km (30 miles)**. Reason: when the engine is not running, the gearbox oil pump does not work and the gearbox is not adequately lubricated for higher speeds or longer distances.

If the vehicle has to be towed with a **breakdown truck**, it must only be suspended at the *front* wheels. Reason: the drive shafts are located on the front wheels. If the car is towed with the rear wheels lifted off the road (i.e. travelling backwards), the drive shafts also turn *backwards*. The planetary gears in the automatic gearbox then turn at such high speeds that the gearbox will be severely damaged in a short time.

**Note**

- If it is not possible to tow the vehicle in the normal way, or if it has to be towed further than 50 km (30 miles), it must be transported on a special car transporter or trailer.
- Should the power supply to the selector lever be interrupted in position P, the selector lever will be locked. Before the vehicle can be recovered/manoeuvred you must manually release the selector lever ⇒ page 163. ■

Fuses and bulbs

Electrical fuses

Changing fuses

A blown fuse can be identified by the blown metal strip.

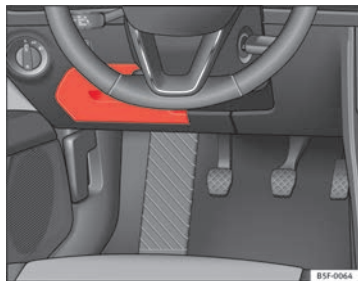

Fig. 131 Steering column area: cover



Fig. 132 Engine compartment, left-hand side: fuse cover

Fuses in the steering column area

- Switch off the ignition and component concerned.
- Look in the tables below for the right fuse for the component ⇒ page 250.
- Remove the cover ⇒ Fig. 131.
- Remove the plastic clips from the fuse cover.
- Use the plastic clip to pull out the fuse and replace the blown fuse with a fuse of the same rating.

Fuses in engine compartment

- Switch off the ignition and component concerned.
- Look in the tables below for the right fuse for the component ⇒ page 251.

- Unlock the fuse cover ⇒ Fig. 132.
- Remove the clips from the fuse cover.
- Use the plastic clip to pull out the fuse and replace the blown fuse with a fuse of the same rating.

The individual electrical circuits are protected by fuses. Fuses are located under a cover below the steering wheel on the left side of the engine compartment.



WARNING

Do not repair fuses, and never replace a blown fuse with a higher amperage fuse. The electrical system could be damaged, with risk of fire.



CAUTION

- Multiple fuse values on the same line (for example, 5/10/20) in the following tables indicate equipment-related differences. Replace the blown fuse with a fuse of the same amperage.
- If a newly replaced fuse blows again after a short time, the electrical system must be checked by a specialised workshop as soon as possible.



Note

- Positions are not occupied by a fuse do not appear in the following tables.
- Some of the equipment listed in the tables below pertain only to certain versions of the model or are an optional extra. ■

Fuses in the vehicle interior

No.	Electrical consumer	Amps
F2	Vacant	-
F4	Alarm	10
F5	Gateway	5
F6	Anti-theft alarm system	5
F7	Air conditioner/heating control panel, selector lever (automatic gearbox), relay coil, rear window heating, additional heating	10
F8	Diagnosis, handbrake switch, light switch, reverse light, interior lighting	10
F9	Vacant	-
F10	Radio display	10
F11	Vacant	-
F12	Radio	20
F13	Vacant	-
F14	Air conditioner fan	40
F15	Vacant	-
F16	Vacant	-
F17	Instrument panel	5
F18	Vacant	-
F19	Vacant	-
F20	Vacant	-
F23	Right lights	40
F24	Sunroof	30
F25	Left door	30
F26	Heated seats	30
F27	Vacant	-
F28	Vacant	-

No.	Electrical consumer	Amps
F29	Vacant	-
F30	Vacant	-
F31	Left lights	40
F32	Parking aid control unit	7,5
F33	Airbag	5
F34	Reverse switch, clima sensor, electrochromic mirror	7,5
F35	Diagnosis, headlight control unit, headlight adjuster	10
F36	Front camera	10
F37	Vacant	-
F38	Vacant	-
F39	Right door	30
F40	12V socket	20
F41	Steering column	20
F42	Central locking	40
F43	Interior light	30
F44	Vacant	-
F45	Vacant	-
F47	Rear window wiper	15
F49	Starter motor; clutch sensor	5
F51	Vacant	-
F53	Heated rear window	30

The electric windows and electric seats* are protected by **circuit breakers**. These switch on again automatically after a few seconds when the overload (caused for example by frozen windows) has been corrected.



Note

Please note that the above list, while correct at the time of printing, is subject to alterations.

Fuses on left side of engine compartment

No.	Electrical consumer	Amps
F1	Vacant	-
F2	ESC control unit	40
F3	Engine control unit (diesel/petrol)	15/30
F4	Engine sensors	5/10
F5	Engine sensors	7,5/10
F6	Brake light sensor	5
F7	Engine power supply	5/10
F8	Lambda probe	10
F9	Engine	5/10/20
F10	Fuel pump control unit	15/20
F11	PTC	40
F12	PTC	40
F13	Automatic gearbox control unit	15/30
F15	Horn	15
F16	Fuel pump control unit	20
F17	Engine control unit	7,5
F18	Terminal 30 (positive reference)	5
F19	Front windscreen washer	30
F20	Alarm horn	10
F22	Engine control unit	5
F23	Starter motor	30

No.	Electrical consumer	Amps
F24	PTC	40
F31	Vacant	-
F32	Vacant	-
F37	Vacant	-



Note

Please note that the above list, while correct at the time of printing, is subject to alterations.

Bulbs

Changing a bulb

Changing bulbs requires a certain degree of practical skill.

If you choose to change engine compartment lamps yourself, remember that it is a dangerous area ⇒ ⚠ in Working on components in the engine compartment on page 209.

Always use identical bulbs with the same designation. The name can be found on the base of the bulb holder.

Depending on how equipped the vehicle is, there are different sets of headlights and tail lights:

- Halogen headlights
- Full-LED main headlights*
- Rear bulb light
- LED rear light*

Full-LED headlight system*

Full-LED headlights handle all light functions (daylight, side light, turn signal, dipped beam and route light) with light emitting diodes (LEDs) as a light source.

Full-LED headlights are designed to last the lifetime of the car and light bulbs cannot be replaced. In case of headlight failure, go to an authorised workshop to have it replaced.

Bulbs (12 V)

Halogen headlights	Type
Daytime driving light/side light	P21W SLL
Dipped beam headlights	H7 LL
Main beam headlights	H7 LL
Turn signal	PY21W LL

Full-LED main headlights	Type
No bulbs may be replaced. All functions are with LEDs	

Front fog light	Type
Fog light/cornering*	H8

Rear bulb light	Type
Brake lights/tail lights	P21W LL
Side lights	2x W5W LL
Turn signal	PY21W LL
Rear fog light	H21W
Reverse lights	P21W LL

LED rear light	Type
Turn signal	PY21W LL
Rear fog light	H21W

LED rear light	Type
Reverse lights	P21W LL
The remaining functions work with LEDs	

 **WARNING**

- Take particular care when working on components in the engine compartment if the engine is warm. Risk of burns.
- Bulbs are highly sensitive to pressure. The glass can break when you touch the bulb, causing injury.
- When changing bulbs, please take care not to injure yourself on sharp edges, in particular on the headlight housing.

 **CAUTION**

- Remove the ignition key before working on the electric system. Otherwise, a short circuit could occur.
- Switch off the lights or parking lights before you change a bulb.
- Take good care to avoid damaging any components.

**For the sake of the environment**

Please ask your specialist retailer how to dispose of used bulbs in the proper manner.

**Note**

- Please check at regular intervals that all lighting (especially the exterior lighting) on your vehicle is functioning properly. This is not only in the interest of your own safety, but also that of all other road users.
- Before changing a bulb, make sure you have the correct new bulb.
- Do not touch the glass part of the bulb with your bare hands, use a cloth or paper towel instead. Otherwise, the fingerprints left on the glass will vaporise as a result of the heat generated by the bulb, they will be deposited on the reflector and will impair its surface. ■

Changing bulbs in headlight unit

Dipped beam bulb

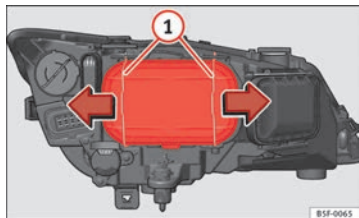

Fig. 133 Dipped beam headlights

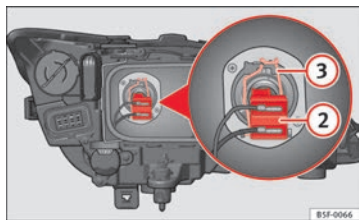

Fig. 134 Dipped beam headlights

- Raise the bonnet
- Move the loops ⇒ Fig. 133 ① in the direction of the arrow and remove the cover.
- Remove connector ⇒ Fig. 134 ② from the bulb.

- Unclip the retainer spring ⇒ Fig. 134 ③ pressing inwards to the right.
- Extract the bulb and fit the replacement so that the rim of the attachment plate is on the reflector cut-out. ■

Daylight bulb

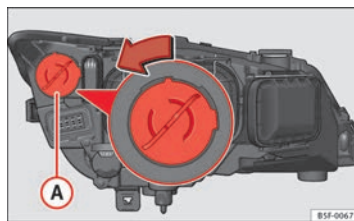

Fig. 135 Daylight bulb

- Raise the bonnet.
- Turn bulb holder ⇒ Fig. 135 A to the left and pull.
- Remove the bulb by pressing on the bulb holder and turning it anti-clockwise at the same time.
- Installation involves all of the above steps in reverse sequence. ■

Turn signal bulb

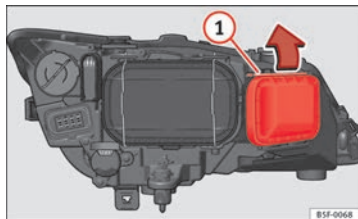

Fig. 136 Turn signal bulb

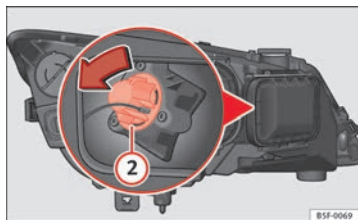

Fig. 137 Turn signal bulb

- Raise the bonnet
- Move the loop ⇒ Fig. 136 ① in the direction of the arrow and remove the cover.
- Turn the bulb holder ⇒ Fig. 137 ② to the left and pull.
- Remove the bulb by pressing on the bulb holder and turning it anti-clockwise at the same time.
- Installation involves all of the above steps in reverse sequence. ■

Main beam bulb

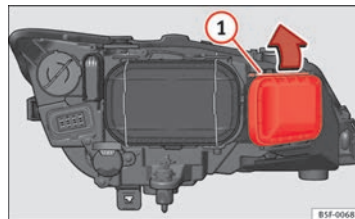

Fig. 138 Main beam bulb

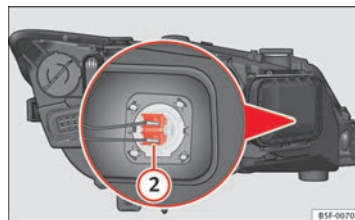

Fig. 139 Main beam bulb

- Raise the bonnet
- Move the loop ⇒ Fig. 138 ① in the direction of the arrow and remove the cover.
- Slide connector ⇒ Fig. 139 ② to the left or right and pull.
- Remove the bulb by disconnecting the connector.
- Installation involves all of the above steps in reverse sequence. ■

Changing bulb for front fog light

Front fog light bulb

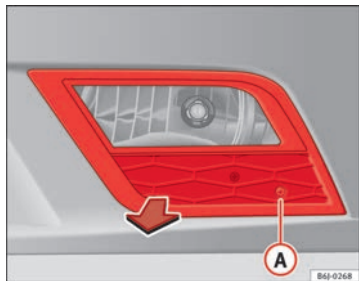

Fig. 140 Front fog light

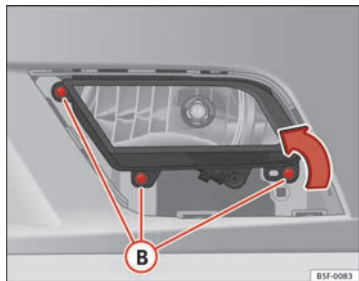

Fig. 141 Front fog light

- Remove the bolt => Fig. 140 **A** from the fog light grille with a screwdriver.
- Remove the bolts (3x) => Fig. 141 **B** to remove the fog light.
- Remove the fog light.



Note

Due to the difficulty of accessing fog light bulbs, have them replaced at a Technical Service or specialised workshop. ■

Fog light, FR version

Due to the difficulty of accessing fog light bulbs, have them replaced at a Technical Service or specialised workshop. ■

Remove the bulb holder

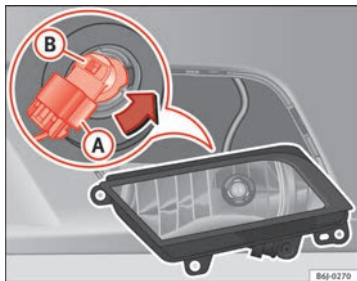

Fig. 142 Front fog light

- Remove connector ⇒ Fig. 142 (A) from the bulb.
- Turn bulb holder ⇒ Fig. 142 (B) to the left and pull.
- Remove the bulb by pressing on the bulb holder and turning it anti-clockwise at the same time.
- Installation involves all of the above steps in reverse sequence.
- Check that the bulb works properly. ■

Changing tail light bulbs (on side panel)

Overview of tail lights

Rear lights on the side panel

Turn signal	PY21W NA LL
Side light and brake light	P21W LL ■

Removing tail light

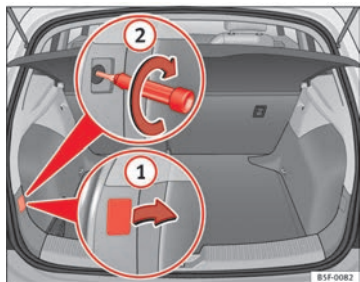

Fig. 143 Luggage compartment: Location of the bolt securing the tail light unit

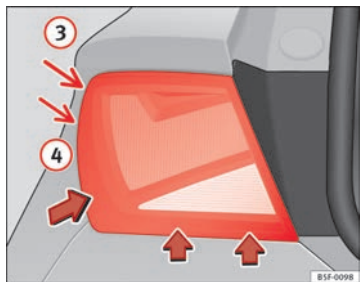

Fig. 144 Remove rear light unit from side panel

- Check which of the bulbs is defective.
- Open the rear lid.

- Remove the cover by prying the flat side of a screwdriver into the recess and remove the cover from the opening ⇒ Fig. 143 ①.
- Carefully loosen the screw located behind the cover with a screwdriver, turning it anti-clockwise (arrows) ⇒ Fig. 143 ②.
- Tilt the light in the direction of the arrows until it comes out (positions ③ and ④ ⇒ Fig. 144).
- Remove the bulb holder ⇒ page 259.



CAUTION

Take care when removing the rear light unit to make sure there is no damage to the paintwork or any of its components.



Note

Make sure you have a soft cloth ready to place under the glass on the rear light unit, to avoid any scratches.

Remove the bulb holder

When changing a bulb, you must first remove the bulb holder.

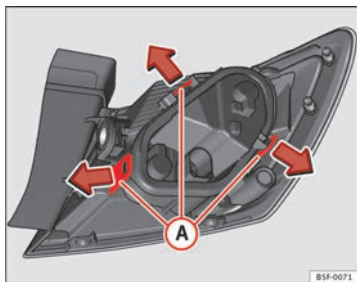

Fig. 145 Retaining tabs on reverse side of tail light

- Remove the bulb holder ⇒ Fig. 145 unlocking the (A) retaining tabs.
- Raise the bulb holder.
- Change the defective bulb.
- To refit follow the steps in reverse order, taking special care when fitting the bulb holder. And especially that all retaining tabs are properly in place.
- Place the light back into place and tighten with a screwdriver.

¹⁾ The above table corresponds to a right-hand traffic vehicle. The position of lights may vary according to the country.

Note

In the case of LED lights, change only the turn signal bulb. ■

Changing tail light bulbs (on rear lid)

Overview of tail lights

Rear lid lights¹⁾

Left side	
Side lights	2x W5W LL
Fog lights	H21 W
Right side	
Side lights	2x W5W LL
Reverse light	P21W LL

Remove the bulb holder

The rear lid must be open to change the bulbs.



Fig. 146 Remove the cover from the rear lid

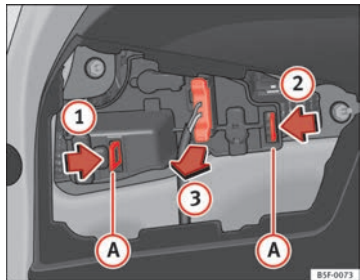

Fig. 147 Remove the bulb holder

- Remove the rear lid cover in the direction indicated ⇒ Fig. 146.

- Unlock the retaining tabs (A) of the bulb holder, following the direction of arrows ① and ② ⇒ Fig. 147.
- Remove the bulb holder by turning it in the direction of arrow ③ ⇒ Fig. 147.

Changing bulbs

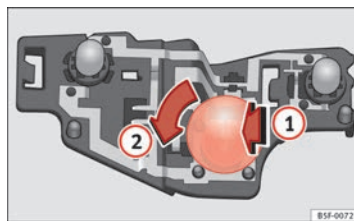



Fig. 148 Position of the bulbs in the bulb holder

- Lightly press the defective bulb into the bulb holder ⇒ Fig. 148 ①, then turn it to the left ② and remove it.
- Fit the new bulb, pressing it into the bulb holder and turn it to the right as far as it will go.
- Use a cloth to remove any fingerprints from the glass part of the bulb.
- Check that the new bulb works properly.
- Replace the bulb holder.

Note

For LED pilots, you can only change the fog or reverse bulb, on the left or right guide.

Fitting the bulb holder

- Install the bulb holder making sure that locking clips  are properly clipped on.
- Replace the cover of the rear lid lining .

Changing number plate light bulbs¹⁾

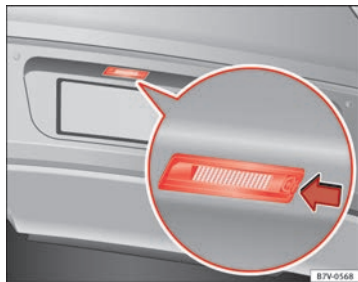

Fig. 149 In the rear bumper: number plate light

¹⁾ Depending on how equipped the vehicle is, the number plate lights may be LEDs. LEDs have an estimated life that exceeds that of the car. If a light with LEDs fails, go to an authorised workshop for replacement.

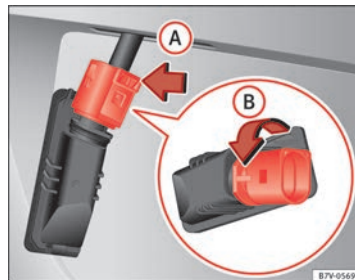











































































































































































































































































































































































































































Fig. 150 Number plate light: remove the bulb holder

Follow the steps indicated:

1. Press the number plate light in the direction of the arrow                                                        

                                                        

                                                        

                                                        

                                                        

                                                        

                                                        

                          

7. Plug the connector into the bulb holder.



Technical specifications

Technical specifications

Important

The information in your vehicle's official documents always take precedence over the information in the current instruction manual.

All technical specifications provided in this documentation are valid for the standard model in Spain. The vehicle data card included in the Maintenance Programme or the vehicle registration documentation shows which engine is installed in the vehicle.

The figures may be different depending whether additional equipment is fitted, for different models, for special vehicles and for other countries.

Abbreviations used in the Technical Specifications section

Abbreviation	Meaning
kW	Kilowatt, engine power measurement.
PS	Pferdestärke (horsepower), formerly used to denote engine power.
rpm	Revolutions per minute - engine speed.
Nm	Newton metres, unit of engine torque.
litres per 100 km	Fuel consumption in litres per 100 km (70 miles).
g/km	Carbon dioxide emissions in grams per km (mile) travelled.
CO ₂	Carbon dioxide
CN	Cetane number, indication of the diesel combustion power.
RON	Research octane number, indication of the knock resistance of petrol.

Vehicle identification data

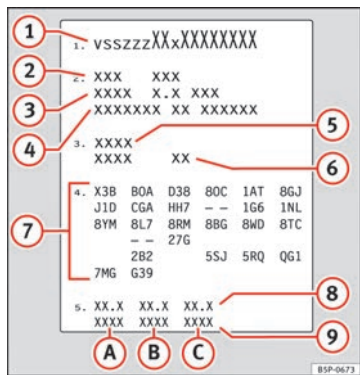

Fig. 151 Vehicle data sticker (luggage compartment)

Chassis number in the Easy Connect

- Select: Function button **CAR** > control button **(Car)* Systems > Service & Control > Chassis number.**

Chassis number

The chassis number is located in the Easy Connect, on the vehicle data sticker and under the windscreen, on the driver side. Additionally, the chassis number is located in the engine compartment, on the right-hand side. The number is engraved on the top side rail, and is partially covered.

Type plate

The type plate is located on the right side door pillar. Vehicles for certain export countries do not have a type plate.

Vehicle data sticker

The vehicle data sticker is under the carpet trim in the luggage compartment, in the spare wheel well. A sticker with the vehicle data is attached to the inside cover of the Maintenance Programme.

The following information is provided on the vehicle data sticker: ⇒ Fig. 151

- 1 Production control number
- 2 Vehicle identification number (chassis number)
- 3 Model code number
- 4 Model designation/engine power output
- 5 Engine and gearbox code letters
- 6 Paintwork number/interior trim code
- 7 Optional equipment codes
- 8 Consumption values
- 9 CO₂ emissions values

At the end of the data sticker, in points 8 and 9, you can see the consumption and emission information.

Identifying letters

The identifying letters of the engine can be viewed on the instrument panel.

Important: The engine must be off and the ignition on.

- Hold down the **(0.0/SET)** **4** ⇒ Fig. 36 button for more than 15 seconds.

Information on consumption and emissions

- A Urban consumption (l/100 km)
Urban CO₂ emissions (g/km)
- B Extra-urban consumption (l/100 km)
Extra-urban CO₂ emissions (g/km)
- C Combined consumption (l/100 km)
Combined CO₂ emissions (g/km)



Information on fuel consumption

Fuel consumption

The consumption and emission details shown on the vehicle data sticker differ from one vehicle to another.

The vehicle fuel consumption and CO₂ emissions can be consulted on the vehicle data sticker in the spare wheel well, inside the luggage compartment and on the rear cover of the Maintenance Programme.

The fuel consumption and CO₂ emission values refer to the weight category assigned to your vehicle according to the engine and gearbox combination, as well as the specific equipment fitted, and is only used to compare between the different models.

The fuel consumption and CO₂ emissions do not depend only on the performance of the vehicle, they can also differ from the established values depending on other factors such as driving style, road conditions, traffic conditions, environmental conditions, load and number of passengers.

Calculation of fuel consumption

The consumption values have been calculated based on measurements performed or supervised by certified CE laboratories according to the latest version of directives 715/2007/EC and 80/1268/CEE (for more information consult the European Union Publications Office at EUR-Lex: © European Union, <http://eur-lex.europa.eu/en/index.htm>) and are valid for the kerb weight indicated for the vehicle.



Note

In practice, and considering all the factors mentioned here, consumption values can differ from those calculated in the current European regulations. ■

Weights

Kerb weight refers to the basic model with a fuel tank filled to 90% capacity and without optional extras. The figure quoted includes 75 kg to allow for the weight of the driver.

For special versions and optional equipment fittings or for the addition of accessories, the weight of the vehicle will increase ⇒ ⚠.



WARNING

- **Please note that the centre of gravity may shift when transporting heavy objects; this may affect vehicle handling and lead to an accident. Always adjust your speed and driving style to suit road conditions and requirements.**
- **Never exceed the gross axle weight rating or the gross vehicle weight rating. If the allowed axle load or the allowed total weight is exceeded, the driving characteristics of the vehicle may change, leading to accidents, injuries and damage to the vehicle.**

Towing a trailer

Trailer weights

Trailer weight

The trailer weights and drawbar loads approved are selected in intensive trials according to precisely defined criteria. The approved trailer weights are valid for vehicles in the EU for maximum speeds of 80 km/h (50 mph) (in certain circumstances up to 100 km/h, 60 mph). The figures may be different in other countries. All data in the official vehicle documentation takes precedence over these data at all times ⇒ ⚠. ▶

Drawbar loads

The *maximum* permitted drawbar load on the ball joint of the towing bracket must not exceed **80 kg**.

In the interest of road safety, we recommend that you always tow approaching the maximum drawbar load. The response of the trailer on the road will be poor if the drawbar load is too small.

If the maximum permissible drawbar load cannot be met (e.g. with small, empty and light-weight single axle trailers or tandem axle trailers with a wheelbase of less than 1 metre), a minimum of 4% of the actual trailer weight is legally required for the drawbar load.



WARNING

- For safety reasons, do not exceed the 80 km/h (50 mph) limit. This is also valid in countries where higher speeds are permitted.
- Never exceed the maximum trailer weights or the drawbar load. If the permissible axle load or the permissible total weight is exceeded, the driving characteristics of the vehicle may change, leading to accidents, injuries and damage to the vehicle.

Wheels

Tyre pressure, snow chains, wheel bolts

Tyre pressures

The sticker with the tyre pressure values can be found on the inside of the fuel tank flap. The tyre pressure values given there are for *cold* tyres. The slightly raised pressures of warm tyres must not be reduced. ⇒

Snow chains

Snow chains may be fitted only to the front wheels, and only for the following tyres:

175/70R14	Chains with links not exceeding 15 mm (including the chain closure)
185/60R15	Chains with links not exceeding 9 mm (including the chain closure)
215/45R16	Chains with links not exceeding 7 mm (including the chain closure)
215/40R17	Chains with links not exceeding 7 mm (including the chain closure)

Wheel bolts

After the wheels have been changed, the **tightening torque** of the wheel bolts should be checked as soon as possible with a torque wrench ⇒ . The tightening torque for steel and alloy wheels is **120 Nm**.



WARNING

- Check the tyre pressure at least once per month. Checking the tyre pressure is very important. If the tyre pressure is too high or too low, there is an increased danger of accidents, particularly at high speeds.
- If the tightening torque of the wheel bolts is too low, they could loosen while the vehicle is in motion. Risk of accident! If the tightening torque is too high, the wheel bolts and threads can be damaged.



Note

We recommend that you ask your Technical Service for information about appropriate wheel, tyre and snow chain size.

Engine specifications

Checking fluid levels

From time to time, the levels of the different fluids in the vehicle must be checked. Never fill with incorrect fluids, otherwise serious damage to the engine may be caused.

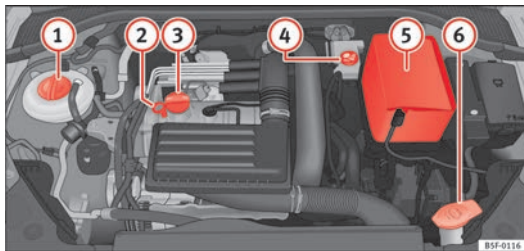

Fig. 152 Diagram for the location of the various elements

- 1 Coolant expansion tank
- 2 Engine oil dipstick
- 3 Engine oil filler cap
- 4 Brake fluid reservoir
- 5 Vehicle battery (underneath the cover)
- 6 Windscreen washer reservoir

The checking and refilling of service fluids are carried out on the components mentioned above. These operations are described in ⇒ page 209.

Overview

You will find further explanations, instructions and restrictions on the technical specifications as of ⇒ page 263. ■

Petrol engine 1.2 63 kW (85 PS)

Engine specifications

Power output in kW (PS)	rpm	63 (85)/ 4300-5300
Maximum torque	in Nm at rpm	160/ 1400-3500
No. of cylinders/capacity	in cm ³	4/ 1197
Fuel		Super 95 RON ^{a)}

^{a)} Research Octane Number = Anti-detonation rating of the petrol.

Performance

Maximum speed	in km/h (mph)	179 (V)
Acceleration from 0-80 km/h (0-60 mph)	in sec.	7,7
Acceleration from 0-100 km/h (0-60 mph)	in sec.	11,7

Weights

Gross vehicle weight	in kg	1720
Weight in running order (with driver)	in kg	1192
Gross front axle weight	in kg	910
Gross rear axle weight	in kg	860
Permitted roof load	in kg	75

Trailer weight

Trailer without brakes	in kg	590
Trailer with brakes, gradients up to 8%	in kg	1300
Trailer with brakes, gradients up to 12%	in kg	1100

Petrol engine 1.2 77 kW (105 PS)

Engine specifications

Power output in kW (PS)	rpm	77 (105)/ 4500-5500
Maximum torque	in Nm at rpm	175/ 1400-4000
No. of cylinders/capacity	in cm ³	4/ 1197
Fuel		Super 95 RON ^{a)}

a) Research Octane Number = Anti-detonation rating of the petrol.

Performance

		Manual	Start-Stop	Automatic
Maximum speed	in km/h (mph)	192 (V)	193 (V)	191 (VI)
Acceleration from 0-80 km/h (0-60 mph)	in sec.	6,7	6,6	6,8
Acceleration from 0-100 km/h (0-60 mph)	in sec.	10,1	10	10

Weights

		Manual	Start-Stop	Automatic
Gross vehicle weight	in kg	1720	1740	1760
Weight in running order (with driver)	in kg	1194	1205	1229
Gross front axle weight	in kg	910	920	950
Gross rear axle weight	in kg	860	870	860
Permitted roof load	in kg	75	75	75

Trailer weight

		Manual	Start-Stop	Automatic
Trailer without brakes	in kg	590	600	610
Trailer with brakes, gradients up to 8%	in kg	1500	1500	1500
Trailer with brakes, gradients up to 12%	in kg	1300	1300	1300

Petrol engine 1.4 90 kW (122 PS) Start-Stop

Engine specifications

Power output in kW (PS)	rpm	90 (122)/ 5000-6000
Maximum torque	in Nm at rpm	200/ 1400-4000
No. of cylinders/capacity	in cm ³	4/ 1395
Fuel		Super 95 RON ^{a)}

^{a)} Research Octane Number = Anti-detonation rating of the petrol.

Performance

Maximum speed	in km/h (mph)	202 (V)
Acceleration from 0-80 km/h (0-60 mph)	in sec.	6,2
Acceleration from 0-100 km/h (0-60 mph)	in sec.	9,3

Weights

Gross vehicle weight	in kg	1760
Weight in running order (with driver)	in kg	1224
Gross front axle weight	in kg	930
Gross rear axle weight	in kg	880
Permitted roof load	in kg	75

Trailer weight

Trailer without brakes	in kg	610
Trailer with brakes, gradients up to 8%	in kg	1700
Trailer with brakes, gradients up to 12%	in kg	1400

Petrol engine 1.4 103 kW (140 PS) Start-Stop

Engine specifications

Power output in kW (PS)	rpm	103 (140)/ 5000
Maximum torque	in Nm at rpm	250/ 1500-3500
No. of cylinders/capacity	in cm ³	4/ 1395
Fuel		Super 95 RON ^{a)} /Normal 91 RON ^{b)}

a) Research Octane Number = Anti-detonation rating of the petrol.

b) With a slight power loss

Performance

Maximum speed	in km/h (mph)	212 (V&VI)
Acceleration from 0-80 km/h (0-60 mph)	in sec.	5,8
Acceleration from 0-100 km/h (0-60 mph)	in sec.	8,2

Weights

Gross vehicle weight	in kg	1740
Weight in running order (with driver)	in kg	1228
Gross front axle weight	in kg	910
Gross rear axle weight	in kg	880
Permitted roof load	in kg	75

Trailer weight

Trailer without brakes	in kg	610
Trailer with brakes, gradients up to 8%	in kg	1800
Trailer with brakes, gradients up to 12%	in kg	1500

Engine oil filling capacity

Approximate engine oil capacity with oil filter change	4.0 litres
--	------------

Petrol engine 1.8 132 kW (180 PS) Start-Stop

Engine specifications

Power output in kW (PS)	rpm	132 / 5100-6200
Maximum torque	in Nm at rpm	250 / 1250-3900
No. of cylinders/capacity	in cm ³	4 / 1798
Fuel		Super 95 RON ^{a)}

a) Research Octane Number = Anti-detonation rating of the petrol.

Performance

		Manual	Automatic
Maximum speed	in km/h (mph)	225 (V&V)	225 (V)
Acceleration from 0-80 km/h (0-60 mph)	in sec.	5,5	5,5
Acceleration from 0-100 km/h (0-60 mph)	in sec.	7,5	7,5

Weights

		Manual	Automatic
Gross vehicle weight	in kg	1810	1820
Weight in running order (with driver)	in kg	1300	1315
Gross front axle weight	in kg	980	1000
Gross rear axle weight	in kg	880	870
Permitted roof load	in kg	75	75

Trailer weight

		Manual	Automatic
Trailer without brakes	in kg	650	650
Trailer with brakes, gradients up to 8%	in kg	1800	1800
Trailer with brakes, gradients up to 12%	in kg	1500	1500

Diesel engine 1.6 66 kW (90 PS)

Engine specifications

Power output in kW (PS)	rpm	66 (90) /2750-4800
Maximum torque	in Nm at rpm	230/1400-2750
No. of cylinders/capacity	in cm ³	4/1598
Fuel		Diesel according to standard EN 590, Min. 51 CN

Performance

Maximum speed	in km/h (mph)	179 (IV)
Acceleration from 0-80 km/h (0-60 mph)	in sec.	8,2
Acceleration from 0-100 km/h (0-60 mph)	in sec.	12,6

Weights

Gross vehicle weight	in kg	1820
Weight in running order (with driver)	in kg	1281
Gross front axle weight	in kg	990
Gross rear axle weight	in kg	850
Permitted roof load	in kg	75

Trailer weight

Trailer without brakes	in kg	640
Trailer with brakes, gradients up to 8%	in kg	1700
Trailer with brakes, gradients up to 12%	in kg	1400

Diesel engine 1.6 77 kW (105 PS)

Engine specifications

Power output in kW (PS)	rpm	77 (105) /3000-4000
Maximum torque	in Nm at rpm	250/1500-2750
No. of cylinders/capacity	in cm ³	4/1598
Fuel		Diesel according to standard EN 590, Min. 51 CN

Performance

		Manual	Start-Stop	Automatic
Maximum speed	in km/h (mph)	192 (V)	192 (V)	190 (V)
Acceleration from 0-80 km/h (0-60 mph)	in sec.	7,3	7,3	7,1
Acceleration from 0-100 km/h (0-60 mph)	in sec.	10,7	10,7	10,9

Weights

		Manual	Start-Stop	Automatic
Gross vehicle weight	in kg	1810	1820	1830
Weight in running order (with driver)	in kg	1274	1286	1303
Gross front axle weight	in kg	990	990	1020
Gross rear axle weight	in kg	870	850	860
Permitted roof load	in kg	75	75	75

Trailer weight

		Manual	Start-Stop	Automatic
Trailer without brakes	in kg	630	640	650
Trailer with brakes, gradients up to 8%	in kg	1800	1800	1800
Trailer with brakes, gradients up to 12%	in kg	1500	1500	1500

Diesel engine 2.0 110 kW (150 PS)

Engine specifications

Power output in kW (PS)	rpm	110 (150) /3500-4000
Maximum torque	in Nm at rpm	320/1750-3000
No. of cylinders/capacity	in cm ³	4/1968
Fuel		Diesel according to standard EN 590, Min. 51 CN

Performance

		Manual	Start-Stop	Automatic
Maximum speed	in km/h (mph)	211 (V)	211 (V)	210 (V)
Acceleration from 0-80 km/h (0-60 mph)	in sec.	6,2	6,2	6
Acceleration from 0-100 km/h (0-60 mph)	in sec.	8,7	8,7	8,7

Weights

		Manual	Start-Stop	Automatic
Gross vehicle weight	in kg	1810	1810	1830
Weight in running order (with driver)	in kg	1302	1305	1326
Gross front axle weight	in kg	990	1000	1010
Gross rear axle weight	in kg	870	880	860
Permitted roof load	in kg	75	75	75

Trailer weight

		Manual	Start-Stop	Automatic
Trailer without brakes	in kg	650	650	660
Trailer with brakes, gradients up to 8%	in kg	1800	1800	1800
Trailer with brakes, gradients up to 12%	in kg	1600	1600	1600

Dimensions and capacities

Dimensions		
Length, width	4263 mm/1816 mm	
Height at kerb weight	1459 mm	
Front and rear projection	853 mm/774 mm	
Wheelbase	2636 mm	
Turning circle	10.9 m	
Track width ^{a)}	Front	Rear
	1533 mm	1504 mm
	1549 mm	1520 mm
Capacities		
Fuel tank	50 litres	
Windscreen washer fluid container with headlight washer	b)	
Tyre pressure		
Summer-grade tyres:		
The correct tyre pressure can be seen on the sticker on the inside of the tank flap.		
Winter tyres:		
The pressure of these tyres is the same as the summer tyre pressure plus 0.2 bar.		

a) This data will change depending on the type of wheel rim.

b) Data not available as this edition goes to print



Index

- ## A
- ABS
 - see Anti-lock brake system 183
 - Accessories 129
 - Acoustic parking aid 178
 - Acoustic warnings
 - Headlights 108
 - Additional electrical appliances (efficiency programme) 78
 - Adjusting
 - the head restraints 128
 - Adjusting the head restraint
 - Front head restraint 127
 - Airbag 30
 - Airbag covers 37
 - Airbag system 30
 - Control lamp 33
 - Curtain airbags 42
 - Differences between front passenger front airbag systems 32
 - Front airbags 35
 - Knee airbag 38
 - side airbags 39
 - Air pressure (tyres) 223
 - Alarm system 93
 - Alcantara: cleaning 204
 - Ambient lighting 115
 - Anti-dazzle rear vision mirror 123
 - Anti-dazzle rear vision mirrors 123
 - Anti-freeze protection
 - Windscreen washer system 220
 - Anti-lock brake system 183
 - Anti-theft alarm 86, 93
 - see also Anti-theft alarm system 86
 - Anti-theft alarm system
 - Interior monitoring 95
 - Tow-away protection 95
 - Anti-theft security system 86, 97
 - Anti-theft wheel bolts 237
 - Antifreeze 215
 - Aspects to take into account before starting the vehicle 8
 - ASR
 - see Traction control system 183
 - Assistance systems 164
 - Cruise control 164
 - Parking aid 179
 - Assisted starting 241
 - Assist systems
 - Tyre monitoring indicator 177
 - Audible warning 20
 - Auto Lock (central locking) 86
 - Automatic car washes
 - see Washing 198
 - Automatic dipped beam control 109
 - Automatic gearbox 154
 - Backup programme 162
 - Downhill speed control 158
 - Driving tips 156
 - Kick-down feature 160
 - Launch Control Programme 160
 - Manual release of selector lever 163
 - Safety interlock for ignition key 144
 - Selector lever lock 155
 - Selector lever positions 154
 - Steering wheel with gearshift paddles ... 159
 - tiptronic 154, 159
- ## B
- Balanced (wheels) 223
 - Ball coupling 195
 - Battery 217
 - Assisted starting 241
 - Charge Level 187
 - Charging 219
 - Disconnecting/Connecting 217
 - Power Management 187
 - Replacement 219
 - Winter conditions 217
 - Before starting the vehicle 8
 - Biodiesel 207
 - Bioethanol
 - see Ethanol (fuel) 206

- Brakes 185
 - Brake fluid 217
 - Brake servo 185
 - New brake pads 185
- Braking
 - Brake assist system 183
 - Moving off on a hill 148
- C**
- Carbon components: Cleaning 200
- Care 198
- Care of vehicle 198
- Care (paint care) 200
- Catalytic converter 190
- CD-ROM reader (navigation) 130
- Central locking
 - Anti-theft alarm 93
 - Central locking switch 93
 - Electric windows 101
 - Programming 92
 - Remote control key 91
 - Selective unlocking system 91
 - Sliding/tilting sunroof 101
- Central locking system 86
 - Manual locking in an emergency 97
 - Rear lid 98
- Cetane number (Diesel fuel) 207
- Changing
 - Windscreen and rear window wiper blades 221
- Changing a bulb 252
 - Bulb sizes 252
- Changing gear
 - Engaging gears (manual gearbox) 152
 - Manual gearbox 152
- Changing main headlight
 - main beam 255
 - turn signal 255
- Changing main headlight bulbs
 - daylight bulb 254
 - Dipped beam 254
- Changing the battery
 - of the vehicle key 90
- Chassis number 264
- Child-proof lock
 - Electric windows 100
- Child safety 47
- Child seat
 - Categorisation in groups 49
 - Group 1 50
 - Group 2 50
 - Group 3 50
 - Groups 0 and 0+ 49
 - Safety notes 47
 - Securing 52
- Child seats 49
 - ISOFIX system 54
 - on the front passenger seat 31
 - Top Tether system 54, 55
- Cleaning 198
 - Alcantara 204
 - Carbon components 200
 - Display/Easy Connect control panel 202
 - Exhaust pipe 201
- Leather 203
- Plastic parts 200, 202
- Radio display 202
- Rims 201
- Seat belts 205
- Trim parts 202
- Trims 200
- Washing the vehicle 198
- Windows 201
- Windscreen and rear window wiper blades 221
- Cleaning/De-icing the windows 201
- Cleaning the rims 201
- Cleaning the upholstery
 - Natural leather 203
- Closing
 - Bonnet 210
 - Panoramic sliding sunroof 103
 - Panoramic sunroof 103
 - Windows 100
- Clutch (warning lamp) 162
- Coming Home 113
- Compartments 129
- Consumption (fuel) 264
- Control lamp
 - Airbag system 33
 - Cruise control 164
 - Tyre monitor indicator warning lamp 175
 - Tyre monitoring systems 175
 - Windscreen wiper fluid level 117
- Control lamps
 - Lights 106
- Control of function
 - Rain sensor 120

- Controls and displays (overview) 59
- Control Units 189
- Convenience closing
 Panoramic sliding sunroof 104
- Convenience opening
 Panoramic sliding sunroof 104
- Convenience opening/closing 101
- Cooling system
 Checking the coolant 216
 Coolant temperature gauge 67
 Topping up coolant 216
- Cornering lights 109
- Correct adjustment of front seat head restraints 14
- Correct adjustment of rear seat head restraints
 In-use and non-use positions 15
- Correct sitting position
 front passenger 12
 Incorrect sitting position 15
 passenger 13
- Cruise control 164
 Control lamp 164
 Operation 166
 Warning lamp 164
- Cruise control system 164
- Curtain airbags 42
 Description 42
 Operation 42
 Safety notes 43
- D**
- Danger of fitting a child seat on the front passenger seat 31
- Data recorder 189
- Daytime driving light 109
- DEF (instrument panel) 67
- Depth of tread 225
- Diagnostic connection 189
- Diesel
 Engine oil 211
 Particulate filter Diesel 190
 Preheating 144
- Digital clock 61
- Dipped beam headlight 108
- Direction of rotation (tyres) 239
- Disabling the airbag 44
- Display 61, 62
- Display/Easy Connect control panel: Cleaning 202
- Disposal
 Airbags 34
 Seat belt tensioners 29
- Door/rear lid warning 73
- Downhill speed control 158
- Drink holders 129
- Driver
 see Correct sitting position 11, 12, 13
- Driver information system
 CD/radio display 73
 Door/rear lid warning 73
 Engine oil temperature display 77
- Operation via the windscreen wiper lever . . . 73
- Outside temperature display 73
- Driving
 With a trailer 194, 195
- Driving abroad
 Headlights 112
- Driving safety 8
- Driving through water 190
- Dynamic headlight range control 114
- E**
- E10
 see Ethanol (fuel) 206
- Easy Connect 79
- Economic driving 191
- Efficiency programme
 Additional electrical appliances 78
 Saving tips 78
- Electrical accessories
 see Power socket 129
- Electric windows 100
 Convenience opening/closing 101
- Electro-mechanical steering 186
 Warning lamp 186
- Electronic differential lock 183
- Electronic Self-locking 183
- Electronic Stability Control (ESC) 183
- Emergencies 232
- Automatic gearbox Backup programme .. 162
- Replacing the battery 219
- Emergency braking warning 111

- Emergency locking and unlocking 96
- Engine
- Assisted starting 241
 - Preheating 144
 - Start-Stop system 149
 - Starting up 144
 - Starting up (driver messages with the mechanical contact) 145
 - Switching off (engine) 146
- Engine compartment
- Closing the bonnet 210
 - Opening the bonnet 210
 - Safety notes 209
- Engine coolant
- G 12 plus-plus 215
 - G 13 215
 - Specifications 215
- Engine oil 211
- Changing 214
 - Checking oil level 212
 - Consumption 212
 - Engine oil dipstick 212
 - Inspection service 211
 - Longlife inspection service 211
 - Oil properties 212
 - Replace 211
 - Service intervals 211
 - Specifications 211
 - Temperature display 77
 - Topping up 213
- Environment
- Ecological driving 191
 - Environmental friendliness 192
- Environmental tip
- Leaks 210
- Environmental tips
- Filling the tank 207, 208
- Environment warning 179
- ESC
- Electronic stability control 183
 - Mode Sport 184
 - Multi-collision brake 184
 - ESC Sport 184
- Ethanol (fuel) 206
- Exhaust tail pipe: Cleaning 201
- extending the rear lid locking time
- see rear lid 99
- Exterior anti-dazzle rear vision mirrors
- 123
- Exterior lighting
- Changing a bulb 252
- Exterior mirrors
- Adjust 122
 - heated 122
 - Heating 122
- F**
- Fastening rings 18, 133
- Fault in the gearbox (warning lamp) 162
- Fault memory 189
- Faults
- Panoramic sliding sunroof 103
 - Faults in the gearbox (warning lamps) 162
- Faulty bulbs
- Changing a bulb 252
- Filling the tank 207
- Fuel gauge 67
- Opening the fuel tank cap 207
- Floor mats 17
- Fog light 108
- Fold
- the seats 132
 - Fold the back seats 132
- Front airbags 35
- Description 35
 - Operation 36
 - Safety notes 37
- Front armrest 125
- Fuel 206
- Consumption 264
 - Diesel 207
 - Ethanol 206
 - Fuel gauge 67
- Fuel consumption 264
- Full-LED headlights 252
- Fuses
- Changing 249
 - Provision 250
- G**
- Gear-change indicator 68
- Gearbox DSG
- see Automatic gearbox 154
- Gear recommendation 68

- Gearshift paddles (automatic gearbox) 159
- General overview of the engine compartment 267
- Glass
- Cleaning/De-icing 201
- Glove compartment 130
- Multiple CD loader 130
- Glove compartment lighting 115
- H**
- Handbrake 147
- Warning lamp 147
- Hazard warning lights 110
- Headlight range control 114
- Headlights
- Changing a bulb 252
 - Dipped beam headlights 108
 - Driving abroad 112
 - Headlight control 108
 - Headlight washers 119
 - Side light 108
- Heated rear window 136, 138
- Hill hold assist 148
- see also* Hill hold assist 148
- Horn 59
- How to jump start description 242
- I**
- Identification plate 264
- Identifying letters of engine 264
- Ignition lock 144
- Increase capacity
- of luggage compartment 132
- Indicator
- Vehicle key 89
- Inertia mode 161
- Information on emissions 264
- Inspection service 211
- Installation of exhaust gas filtration systems
- Catalytic converter 190
 - Particulate filter Diesel 190
- Instrument cluster 61
- Instrument panel 61
- Display 61, 62
 - Instruments 61
 - Lamps 69
 - Service interval display 65
- Instrument panel lighting 114
- Interior anti-dazzle rear vision mirrors 123
- Interior monitoring 95
- Interior rear vision mirror
- see* Rear vision mirrors 123
- ISOFIX system 54
- J**
- Jack 232
- Mounting points 238
- Jump leads 241
- Jump starting 241
- K**
- Key
- Driver messages (mechanical contact) . . . 145
 - Unlocking/Locking 91
- Keys
- Assigning a key 88
 - Changing the battery (vehicle key) 90
 - Indicator 89
 - Locking/Unlocking 97
 - Remote control 88
 - Spare key 88
 - Vehicle key 88
- Kick-down
- Manual gearbox 146
- Kick-down feature
- Automatic gearbox 160
- Knee airbag
- See* "Airbag system" 38
- L**
- Lamps
- Audible warnings 69
 - Control lamps 69
 - Warning lamps 69
- Lane Assist 168
- Cleaning the camera area 199
- Lane Assist system
- see* Lane Assist 168
- Launch Control Programme (automatic gearbox) 160

- Leather Care
 - Natural leather 203
 - Leather: Care 203
 - Leaving Home 113
 - Lighting
 - Changing a bulb 252
 - Lights 106
 - Acoustic warnings 108
 - AUTO 109
 - Changing a bulb 252
 - Coming home 113
 - Control lamps 106
 - Controls lighting 114
 - Cornering lights 109
 - Daytime driving light 109
 - Fog light 108
 - Functions 109
 - Headlight range control 114
 - Instrument lighting 114
 - Interior lights 115
 - Leaving home 113
 - Main beam lever 107
 - Motorway lights 109
 - Parking light 109
 - Reading lights 115
 - Turn signal lever 107
 - Load compartment in the luggage compartment
 - see Loading the luggage compartment ... 17
 - Loading the luggage compartment 17
 - Locking/Unlocking
 - In the lock cylinder 97
 - With the central locking switch 93
 - Longlife inspection service 211
 - Luggage carrier 131
 - Luggage compartment 131
 - Cover 132
 - Fastening rings 133
 - Luggage compartment lighting 115
 - see also Loading the luggage compartment 17
 - Lumbar support 125
- M**
- Main beam assist 111
 - Main beam headlight 108
 - Main beam lever 107
 - Maintenance
 - Airbags 34
 - Manual gearbox 152
 - Kick-down 146
 - Manual locking of passenger door in an emergency 97
 - Manual operation
 - Selector lever 163
 - Manual operation in an emergency
 - Passenger door 97
 - Rear lid 99
 - Mobile phones 230
 - Modifications (technical) 230
 - Motorway lights 109
 - Mounting pin (tyre change) 232
 - Mounting points (jack) 238
 - Moving off
 - Hill hold assist 148
 - Multi-collision Brake 184
 - Multiple CD loader 130
- N**
- Navigation system
 - CD-ROM Reader 130
 - Note regarding the environment
 - Roof carrier 131
 - Number of colour 264
 - Number of seats 19
- O**
- Object holders 129
 - Octane rating (petrol) 206
 - Odometer 61
 - Oil change 214
 - Oil properties 212
 - One-touch opening and closing
 - Electric windows 101
 - Opening 86
 - Bonnet 210
 - Fuel tank flap 207
 - Panoramic sliding sunroof 103
 - Panoramic sunroof 103
 - Rear lid 98
 - Windows 100
 - Opening/Closing
 - In the lock cylinder 97
 - With remote control 91
 - With the central locking switch 93

- Outside temperature 64
 - Outside temperature display 73
 - Overview
 - Turn signal and main beam lever 107
 - Overview (controls and displays) 59
- P**
- Paint code 264
 - Paint damage 200
 - Panoramic sliding sunroof 103
 - Closing 103
 - Convenience closing 104
 - Convenience opening 104
 - Fault 103
 - Opening 103
 - Roll-back function 104
 - Parking 147
 - Parking aid
 - Adjusting the display/audible warnings 181
 - Environment warning 179
 - Fault 181
 - Plus parking aid 179
 - Rear parking aid 179
 - Sensors/Camera: cleaning 199
 - Towing bracket 182
 - Parking aid system
 - see Parking aid 179
 - Parking light 109
 - Parking (automatic gearbox) 156, 157
 - Particulate filter (Diesel) 190
 - Passenger
 - see Correct sitting position 11, 12, 13
 - Pedals 16
 - Physical principles of a frontal collision 21
 - Plastic parts: Cleaning 200, 202
 - Polishing 200
 - Power Management 187
 - Power socket 129
 - Preheating 144
 - Pressure (tyres) 223
- R**
- Racks 130
 - Radio display: cleaning 202
 - Radio transmitters 230
 - Rain sensor 120
 - Control of function 120
 - Rear lid
 - automatic locking 99
 - Central locking system 98
 - Manual release in an emergency 99
 - Rear lights
 - Changing a bulb 252
 - Rear vision mirror 122
 - Rear vision mirrors
 - Adjusting the exterior mirrors 122
 - see also Rear vision mirrors 123
 - Reflective vests 232
 - Remote control
 - See "Keys" 88
 - Remote control key
 - Unlocking/Locking 91
 - Remove the wheel cover 236
 - Removing the head restraint
 - 128
 - Repairs 230
 - Airbags 34
 - Replacement parts 230
 - Reservoir capacity
 - Windscreen washer water reservoir 122
 - Reset button (trip recorder) 67
 - Reset the trip recorder to zero 67
 - Retrofitting a towing bracket 196
 - Rev counter 61, 66
 - Reverse gear (automatic gearbox) 154
 - Rims
 - Cleaning 201
 - RME (fuel) 207
 - Roll-back function
 - Panoramic sliding sunroof 104
 - Windows 102
 - Roof carrier (roof load) 131
 - Running in
 - New brake pads 185
 - New engine 190
 - New tyres 223
- S**
- Safe driving 7
 - Safelock
 - see Anti-theft security system 86

- Safety 8
 - child safety 47
 - child seats 47
- Safety equipment 7
- Safety first 7
- Safety interlock for ignition key 144
- Safety notes
 - Airbags 34
 - Curtain airbags 43
 - Front airbags 37
 - Seat belt tensioners 29
 - Side airbags 41
 - Using child seats 47
 - Using seat belts 23
- Saving fuel
 - Conscientious driving 191
 - Inertia mode 161
- Saving tips (efficiency programme) 78
- Seat
 - adjustment 125
- Seat adjuster 10
- Seat belt control lamp 19
- Seat belt position
 - Pregnant women 27
 - Seat belts 26
- Seat belt protection 23
- Seat belt release 27
- Seat belts 19
 - Adjustment 25
 - Cleaning 205
 - control lamp 19
 - Incorrectly fastened 28
 - Not worn 22
 - Safety notes 23
 - Seat belt tensioners 28
 - SEAT Drive Mode 171
 - Selective unlocking system 91
 - Selector lever
 - Automatic gearbox 154
 - Function fault 155
 - Selector lever (automatic gearbox)
 - Manual release 163
 - Service interval display 65
 - Service intervals 211
 - Service notification: read 66
 - Setting
 - Headlight range 114
 - Side airbags 39
 - Description 39
 - Operation 40
 - Safety notes 41
 - side assist
 - Cleaning the sensors 199
 - Side light 108
 - Sitting position
 - driver 11
 - Sitting position for vehicle occupants 10
 - Sliding/tilting sunroof
 - Convenience opening/closing 101
 - Snow chains 229, 266
 - Spanner symbol 65
 - Special features
 - Windscreen wipers 118
 - Speedometer 73
 - Speed warning function 149
 - Start-Stop system 149
 - Driver messages 152
 - Stop/Start the engine 150
 - Switching on/off 152
 - The engine does not switch off 151
 - The engine starts by itself 151
 - Warning lamps 150
 - Starting up (engine) 144
 - Steering
 - Electro-mechanical steering 186
 - Engage the steering lock (ignition key) 144, 146
 - Steering wheel
 - Gearshift paddles (automatic gearbox) .. 159
 - Setting 143
 - Storage compartment 130
 - Storage compartments
 - Glove compartment lighting 115
 - Sun visor 116
 - Switch
 - Hazard warning lights 110
 - Switching ignition on/off 144
 - Switching off using inertia 191
 - Switching off (engine)
 - With the key 146
 - Symbols
 - See "Lamps" 69
 - System
 - Automatic dipped beam control 109
 - System Easy Connect 79

- Systems
- Cruise control 164
 - Tiredness detection 173
 - Tyre monitoring indicator 177
 - Tyre monitoring systems 175
- T**
- Technical data
- Reservoir capacity 122
- Technical modifications 230
- Technical specifications 263
- Temperature display
- Engine oil 77
 - Outside temperature 64, 73
- The danger of not using the seat belt 22
- Tightening torque of wheel bolts 266
- tiptronic (automatic gearbox) 154
- Tiptronic (automatic gearbox) 159
- Tiredness detection 173
- Tools 232
- Top Tether system 54, 55
- Tow-away protection 95
- Tow-starting the engine 244
- Tow-starting the vehicle 244
- Towing
- Retrofitting a towing bracket 196
 - Towing a trailer 194, 265
 - Towing bracket 195
 - Towline anchorage 232
 - Traction control system 183
- Trailer
- Parking aid 182
 - Trailer weights 265
 - Transporting children 47
 - Trim parts: cleaning 202
 - Trims: Cleaning 200
 - Trip recorder 61, 67
 - Turning off the lights 108
 - Turning on the headlights 108
 - Turn signal convenience function 107
 - Turn signal lever 107
- Tyre
- Tyre pressure 223
 - Useful life 223
 - Tyre Mobility System (Tyre repair kit) 233
 - Tyre monitoring indicator 177
 - Tyre monitoring system 175
 - Tyre monitoring systems
 - Control lamp 175
 - Tyre monitoring indicator 177
 - Tyre pressures 266
 - Tyre repair kit 232
- Tyres
- Accessories 223
 - Changing 235
 - Indications of wear 225
 - Repair kit 232, 233
 - With compulsory direction of rotation 239
- U**
- Unlocking/Locking
- With remote control 91
 - With the central locking switch 93
- Upholstery: Cleaning
- Alcantara 204
 - Fabrics 202
- V**
- Vehicle
- Identification number 264
 - Raising 238
 - Sticker 264
 - Vehicle identification data 264
- Vehicle battery
- Disconnect 66
- Vehicle care
- Changing wiper blades of the windscreen and rear window 221
 - Cleaning windscreen and rear window wiper blades 221
 - Service position 119
- Vehicle interior monitoring and anti-tow system
- Activation 94
- Vehicle key
- Synchronising 90
- Vehicle tools 232
- Ventilation slits 18

W

- Warning lamp
 - Cruise control 164
- Washing
 - Care of the vehicle exterior 198
- Wearing suitable shoes 16
- Wheel
 - changing 225
- Wheel bolts 227, 266
 - Anti-theft 237
 - Loosening 237
 - Removing the cap 236
- Wheel brace 232
- Wheel cover (wheel bolts): removing 236
- Wheels 223, 266
 - Changing 235, 239
- Why assume the correct sitting position? 30
- Why should head restraints be correctly adjusted? 14
- Why wear seat belts? 19, 21, 30
- Windows
 - Electric windows 100
- Windscreen washer 116
- Windscreen washer system 220
- Windscreen washer water
 - Checking 121
 - Topping up 121
- Windscreen wiper 116
 - Window wiper lever 118
- Windscreen wiper fluid
 - Control lamp 117
- Windscreen wipers
 - Functions 119
 - Headlight washer system 119
 - Heated windscreen washer jets 119
 - Lifting the wiper blades 119
 - Rain sensor 120
 - Replacing the wiper blades 119
 - Service position 119
 - Special features 118
- Windscreen wipers service position 119
- Winter conditions
 - Battery 217
 - Care of vehicle 198
 - De-icing the glass 201
 - Diesel 207
 - Snow chains 229
 - Tyres 227
 - Windscreen washer system 220
- Winter operation
 - Headlight washers 119
 - Heated windscreen washer jets 119
 - Salt on the roads 121
- Winter tyres 227

SEAT S.A. is permanently concerned about continuous development of its types and models. For this reason we ask you to understand, that at any given time, changes regarding shape, equipment and technique may take place on the car delivered. For this reason no right at all may derive based on the data, drawings and descriptions in this current handbook.

All texts, illustrations and standards in this handbook are based on the status of information at the time of printing. Except for error or omission, the information included in the current handbook is valid as of the date of closing print.

Re-printing, copying or translating, whether total or partial is not allowed unless SEAT allows it in written form.

SEAT reserves all rights in accordance with the "Copyright" Act.

All rights on changes are reserved.

 This paper has been manufactured using bleached non-chlorine cellulose.

© SEAT S.A. - Reprint: 15.06.12

Inglés 5F4012003B (06.12) (GT9)



5F4012003B

