

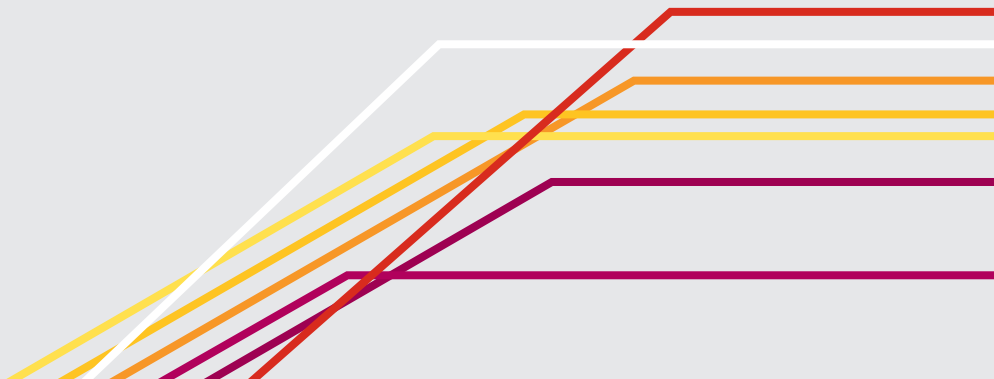

# EXEO ST

Owner's manual





## Foreword

This Instruction Manual and its corresponding supplements should be read carefully to familiarise yourself with your vehicle.

Besides the regular care and maintenance of the vehicle, its correct handling will help preserve its value.

**For safety reasons, note the information concerning accessories, modifications and part replacements.**

If selling the vehicle, give all of the onboard documentation to the new owner, as it should be kept with the vehicle.

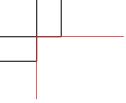

## Table of Contents

<b>Manual structure</b> .....	5	<b>Operating Instructions</b> .....	59	Head restraints .....	141
<b>Content</b> .....	6	Cockpit .....	59	Armrests .....	143
<b>Safety First</b> .....	7	Overview .....	59	Luggage compartment .....	144
Safe driving .....	7	Instruments .....	61	Roof rack / roof rails* .....	152
Brief introduction .....	7	Warning and indicator lamps .....	67	Drink holder .....	153
Proper sitting position for occupants .....	10	Driver information system .....	74	Ashtray*, cigarette lighter* and electric sockets* .....	154
Pedal area .....	16	Auto-check system .....	78	Compartments .....	159
Storing objects .....	16	Speed warning* ☹ .....	85	<b>Air conditioning</b> .....	162
Seat belts .....	19	Onboard computer .....	88	2C Climatronic .....	162
Brief introduction .....	19	Menu display .....	91	<b>Driving</b> .....	172
Why wear seat belts? .....	20	Tyre pressure monitoring* .....	92	Steering .....	172
Seat belts .....	24	<b>Steering wheel controls</b> .....	94	Safety .....	172
Seat belt tensioners .....	28	Multifunction steering wheel* .....	94	Ignition lock .....	173
<b>Airbag system</b> .....	29	<b>Unlocking and locking</b> .....	99	Starting and stopping the engine .....	174
Brief introduction .....	29	Remote control keys .....	99	Start-Stop function* .....	176
Front airbags .....	33	Central locking .....	101	Handbrake .....	179
Knee airbag* .....	36	Rear lid .....	106	Parking aid acoustic system .....	181
Side airbags* .....	39	Childproof lock .....	107	Cruise speed* (Cruise control system) .....	183
Curtain airbags .....	42	Remote control key .....	108	Manual gearbox .....	186
Deactivating airbags .....	45	Anti-theft alarm system* .....	110	Automatic gearbox* .....	187
<b>Child safety</b> .....	47	Electric windows .....	112	<b>Practical Tips</b> .....	195
Brief introduction .....	47	Sliding/tilting sunroof* .....	114	<b>Intelligent technology</b> .....	195
Child seats .....	49	<b>Lights and visibility</b> .....	117	Electronic Stability Control (ESC) .....	195
Securing child seats .....	52	Lights .....	117	Brakes .....	198
		Interior lights .....	125	Power steering .....	199
		Visibility .....	128	Servotronic* .....	200
		Rearscreen wipers .....	129	<b>Driving and the environment</b> .....	201
		Rearview mirrors .....	132	Running-in .....	201
		<b>Seats and storage compartments</b> .....	135	Exhaust gas purification system .....	202
		Manual adjustment of the front seats .....	135	Economical and environmentally friendly driving .....	203
		Electric adjustment of front seats* .....	137	Driving abroad .....	205
		Lumbar support* .....	138		
		Driver seat memory* .....	139		

Trailer towing .....	206	Luggage compartment lights .....	292
Trailer towing .....	206	Registration light .....	292
Removable towing bracket .....	209	Sun visor light .....	293
Vehicle maintenance and cleaning .....	216	Jump-starting .....	293
General notes .....	216	Towing and tow-starting .....	297
Care of the vehicle exterior .....	217		
Vehicle interior maintenance .....	222	<b>Technical Specifications .....</b>	<b>300</b>
Accessories, replacement of parts and modifications .....	228	Description of specifications .....	300
Accessories and spare parts .....	228	Important information .....	300
Technical modifications .....	228	Information on fuel consumption .....	302
Mobile phones and two-way radios .....	229	Towing a trailer .....	302
Athermic windscreen* .....	229	Wheels .....	303
Checking and refilling levels .....	230	Technical specifications .....	304
Refuelling .....	230	Engine specifications .....	304
Petrol .....	231	Dimensions and capacities .....	312
Diesel .....	232		
Bonnet .....	233	<b>Index .....</b>	<b>313</b>
Engine oil .....	235		
Cooling system .....	238		
Washer fluid and windscreen wiper blades .....	241		
Brake fluid .....	244		
Vehicle battery .....	245		
Wheels and tyres .....	249		
Wheels .....	249		
If and when .....	259		
Tools, tyre repair kit and spare wheel .....	259		
Changing a wheel .....	262		
Tyre repair* (Tyre-Mobility-System) .....	266		
Fuses .....	270		
Bulbs .....	272		
Changing bulbs. Halogen headlights .....	273		
Changing bulbs. Bi-Xenon AFS headlights .....	279		
Changing tail light bulbs (on side panel) .....	283		
Changing tail light bulbs (on rear lid) .....	288		
Side turn signals .....	291		

## Manual structure

### What you should know before reading this manual

This manual contains a description of the **equipment** supplied with the vehicle at the time of press. Some of the equipment hereunder described will not be available until a later date, or is only available in certain markets.

**As this is a general manual for the EXEO ST, some of the equipment and functions described in this manual are not included in all types or versions of the model. These may vary or be modified depending on technical and market requirements, which can in no way be interpreted as deceptive advertising.**

The **illustrations** are intended as a general guide and may vary from the equipment fitted in your vehicle in some details.

The **direction indications** (left, right, front, rear) appearing in this manual refer to the normal forward working direction of the vehicle except when otherwise indicated.

**The equipment marked with an asterisk\*\*** is fitted as standard only in certain versions, and is only supplied as optional extras for some versions, or are only offered in certain countries.

- Ⓢ All registered marks are indicated with Ⓢ. Although the copyright symbol does not appear, it is a copyrighted mark.
- ▶ The section is continued on the following page.
- Marks the **end of a section**.



### WARNING

Texts preceded by this symbol contain information on safety. They warn you about possible dangers of accident or injury.



### CAUTION

Texts with this symbol draw your attention to potential sources of damage to your vehicle.



### For the sake of the environment

Texts preceded by this symbol contain relevant information concerning environmental protection.



### Note

Texts preceded by this symbol contain additional information. ■

## Content

This manual is structured to provide the information you need in an organised way. The content of this Manual is divided into **sections** which belong to **chapters** (e.g. "Air conditioning"). The entire manual is divided into five large parts which are:

### 1. Safety First

Information on the vehicle equipment relating to passive safety such as seat belts, airbags, seats, etc.

### 2. Operating instructions

Information about the distribution of controls in the driver position of your vehicle, about the seat adjustment possibilities, about how to create a suitable climate in the passenger compartment, etc.

### 3. Practical Tips

Advice relating to the driving, caring and maintenance of your vehicle and certain problems you can solve yourself.

### 4. Technical specifications

Figures, values and the dimensions of your vehicle.

### 5. Alphabetic index

At the end of this manual there is a detailed alphabetical index, this will help you to rapidly find the information you require. ■

# Safety First

## Safe driving

### Brief introduction

#### Dear SEAT Driver

*Safety first!*

This chapter contains important information, tips, suggestions and warnings that you should read and consider for both your own safety and for your passengers' safety.



#### WARNING

- This manual contains important information about the operation of the vehicle, both for the driver and the passengers. The other sections of the owner's manual also contain further information that you should be aware of for your own safety and for the safety of your passengers.
- Ensure that the onboard documentation is kept in the vehicle at all times. This is especially important when lending or selling the vehicle to another person.

### Safety equipment

*The safety equipment listed here are part of the vehicle's passenger restraint system. They work together to help reduce the risk of injury in a wide variety of accident situations.*

Your safety and the safety of your passengers should not be left to chance. In the event of an accident, the safety features incorporated in your vehicle are capable of reducing the risk of injury. These are just a few of the safety features in your SEAT:

- Three-point seat belts optimised for all seats
- Belt force limiters for the seats
- Belt tension devices for the front seat belts
- Front airbags
- Side airbags in the front and rear seat backrests\*
- Head-protection airbags\*
- Knee airbag for left-hand drive only
- ISOFIX anchor points\* for ISOFIX child safety seats on the outer rear seats
- Height-adjustable head restraints
- Adjustable steering column

These individual safety features are harmonised to provide you and your passengers with the best possible protection in case of an accident. However, they can only be effective if you and your passengers sit in the correct position and adjust and use the safety equipment properly. ►

Therefore, this chapter explains why these safety features are so important, how they can protect you, what you need to remember when using them and how you and your passengers can gain the most benefit from them. There are also a number of important safety warnings that you and your passengers should always observe in order to minimise the risk of injury.

**Safety is everyone's responsibility!** ■

### Before setting off

*The driver is responsible for the safety of the passengers and the safe operation of the vehicle at all times.*

For your own safety and the safety of your passengers, always note the following points before setting off:

- Make sure that all lights and indicators are working properly.
- Check tyre pressure.
- Make sure that all windows are clean and give good visibility to the outside.
- Secure all luggage and other items carefully ⇒ page 16.
- Make sure that no objects can interfere with the pedals.
- Adjust the front seat, head restraint and mirrors correctly.
- Make sure that the head restraints for all passengers are adjusted to the correct position.
- Make sure that children are protected with suitable safety seats and properly worn seat belts ⇒ page 47.

- Sit in a correct position. Inform your passengers as to how they should sit ⇒ page 10.
- Fasten your seat belt correctly. Make sure that your passengers do the same ⇒ page 19. ■

### What affects safe driving?

*Safety on the road is directly related to how you drive, and can also be affected by the passengers in the vehicle.*

The driver is responsible for the safety of the vehicle and all its occupants. If your ability to drive is impaired in any way, you endanger yourself and other road users ⇒ ⚠. Therefore:

- Do not let yourself be distracted by passengers or by using a mobile phone, etc.
- Never drive when your driving ability is impaired (by medication, alcohol, drugs, etc.).
- Obey all traffic regulations and speed limits and always maintain a safe distance to the vehicle in front.
- Always adjust your speed to suit the road, traffic and weather conditions.
- Take frequent breaks on long trips. Do not drive for more than two hours without a stop.
- If possible, avoid driving when you are tired or stressed. ▶

**WARNING**

When driving safety is impaired during a trip, the risk of injury and accidents increases.

**WARNING**

When driving safety is impaired during a trip, the risk of injury and accidents increases.

### What affects driving safety?

*Driving safety is largely determined by your driving style and the personal behaviour of all occupants.*

As a driver, you are responsible for yourself and your passengers. When your concentration or driving safety is affected by any circumstance, you endanger yourself as well as others on the road ⇒ ⚠, for this reason:

- Always pay attention to traffic and do not get distracted by passengers or telephone calls.
- Never drive when your driving ability is impaired (e.g. by medication, alcohol, drugs).
- Observe traffic laws and speed limits.
- Always reduce your speed as appropriate for road, traffic and weather conditions.
- When travelling long distances, take breaks regularly - at least every two hours.
- If possible, avoid driving when you are tired or stressed.

## Proper sitting position for occupants

### Proper sitting position for driver

The proper sitting position for the driver is important for a safe and relaxed driving.

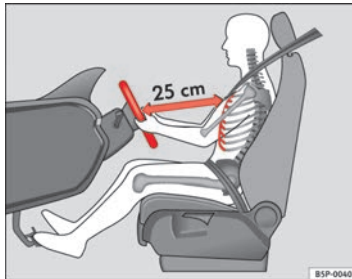

Fig. 1 The proper distance between driver and steering wheel

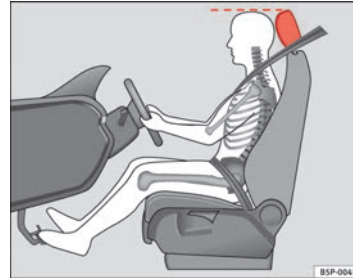

Fig. 2 Proper head restraint position for driver

For your own safety and to reduce the risk of injury in the event of an accident, we recommend the following adjustments for the driver:

- Adjust the steering wheel so that there is a distance of at least 25 cm between the steering wheel and the centre of your chest ⇒ Fig. 1.
- Move the driver seat forwards or backwards so that you are able to press the accelerator, brake and clutch pedals to the floor with your knees still slightly angled ⇒  $\triangle$ .
- Ensure that you can reach the highest point of the steering wheel.
- Adjust the head restraint so that its upper edge is at the same level as the top of your head, or as close as possible to the same level as the top of your head ⇒ Fig. 2.
- Move the backrest to an upright position so that your backrests completely against it. ▶

- Fasten your seat belt securely ⇒ page 19.
- Keep both feet in the footwell so that you have the vehicle under control at all times.

Adjustment of the driver seat ⇒ page 135.

### WARNING

- An incorrect sitting position of the driver can lead to severe injuries.
- Adjust the driver seat so that there is at least 25 cm distance between the centre of the chest and the centre of the steering wheel ⇒ Fig. 1. If you are sitting closer than 25 cm, the airbag system cannot protect you properly.
- If your physical constitution prevents you from maintaining the minimum distance of 25 cm, contact a specialised workshop. The workshop will help you decide if special specific modifications are necessary.
- When driving, always hold the steering wheel with both hands on the outside of the ring at the 9 o'clock and 3 o'clock positions. This reduces the risk of injury when the driver airbag is triggered.
- Never hold the steering wheel at the 12 o'clock position, or in any other manner (e.g. in the centre of the steering wheel). In such cases, if the airbag is triggered, you may sustain injuries to the arms, hands and head.
- To reduce the risk of injury to the driver during sudden braking manoeuvres or an accident, never drive with the backrest tilted far back! The airbag system and seat belts can only provide optimal protection when the backrest is in an upright position and the driver is wearing his or her seat belt properly. The further the backrests are tilted to the rear, the greater the risk of injury due to incorrect positioning of the belt web or to the incorrect sitting position!
- Adjust the head restraint properly to achieve optimal protection. ■

### Proper sitting position for front passenger

*The front passenger must sit at least 25 cm away from the dash panel so that the airbag can provide the greatest possible protection in the event that it is triggered.*

For your own safety and to reduce the risk of injury in the event of an accident, we recommend the following adjustments for the front passenger:

- Move the front passenger seat back as far as possible ⇒ .
- Move the backrest to an upright position so that your backrests completely against it.
- Adjust the head restraint so that its upper edge is at the same level as the top of your head, or as close as possible to the same level as the top of your head ⇒ page 13.
- Keep both feet in the footwell in front of the front passenger seat.
- Fasten your seat belt securely ⇒ page 19.

It is possible to deactivate the passenger airbag in **exceptional circumstances** ⇒ page 25.

Adjusting the front passenger seat ⇒ page 135. ▶

**WARNING**

- An incorrect sitting position of the front passenger can lead to severe injuries.
- Adjust the front passenger seat so that there is at least 25 cm between your chest and the dash panel. If you are sitting closer than 25 cm, the airbag system cannot protect you properly.
- If your physical constitution prevents you from maintaining the minimum distance of 25 cm, contact a specialised workshop. The workshop will help you decide if special specific modifications are necessary.
- Always keep your feet in the footwell when the vehicle is moving; never rest them on the dash panel, out the window or on the seat. An incorrect sitting position exposes you to an increased risk of injury in case of a sudden braking or an accident. If the airbag is triggered, you could sustain severe injuries due to an incorrect sitting position.
- To reduce the risk of injury to the front passenger in events such as sudden braking manoeuvres or an accident, never travel with the backrest tilted far back! The airbag system and seat belts can only provide optimal protection when the backrest is in an upright position and the front passenger is wearing his or her seat belt properly. The further the backrests are tilted to the rear, the greater the risk of injury due to incorrect positioning of the belt web or to the incorrect sitting position!
- Adjust the head restraint properly in order to achieve maximum protection.

**Correct sitting position for passengers in the rear seats**

*Passengers in the rear seats must sit up straight, keep their feet on the footwells, have the head restraints positioned for use and wear their seat belts properly.*

To reduce the risk of injury in the event of a sudden braking manoeuvre or an accident, passengers on the rear bench seat must consider the following:

- Adjust the head restraint to the correct position ⇒ page 14.
- Keep both feet in the footwell in front of the rear seat.
- Fasten your seat belt securely ⇒ page 19.
- Use an appropriate child restraint system when you take children in the vehicle ⇒ page 47.

**WARNING**

- If the passengers on the rear seat are not sitting properly, they could sustain severe injuries.
- Adjust the head restraint properly in order to achieve maximum protection.
- Seat belts can only provide optimal protection when backrests are in an upright position and the passengers are wearing their seat belts properly. If passengers on the rear seat are not sitting in an upright position, the risk of injury due to incorrect positioning of the seat belt increases.

### Correct adjustment of front seat head restraints

*Properly adjusted head restraints are an important part of passenger protection and can reduce the risk of injuries in most accident situations.*

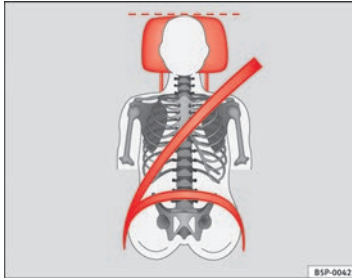

**Fig. 3** Properly adjusted head restraint viewed from the front

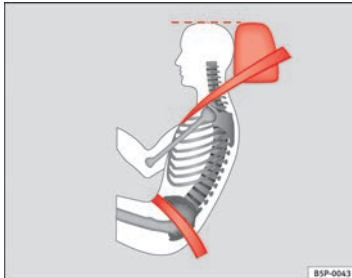

**Fig. 4** Properly adjusted head restraint viewed from the side

Adjust the head restraint properly in order to achieve maximum protection.

- Adjust the head restraint so that its upper edge is at the same level as the top of your head or as close as possible to the same level as the top of your head and, at the very least, at eye level  
⇒ Fig. 3 and ⇒ Fig. 4.

Adjusting the head restraints ⇒ page 135

#### **WARNING**

- Travelling with the head restraints removed or improperly adjusted increases the risk of severe injuries.
- Incorrectly adjusted head restraints could result in death in the event of a collision or accident.
- Incorrectly adjusted head restraints also increase the risk of injury during sudden or unexpected driving or braking manoeuvres.
- The head restraints must always be adjusted according to the passenger's height.

### Correct adjustment of rear seat head restraints

*Properly adjusted head restraints are an important part of the passenger protection and can reduce the risk of injuries in most accident situations*

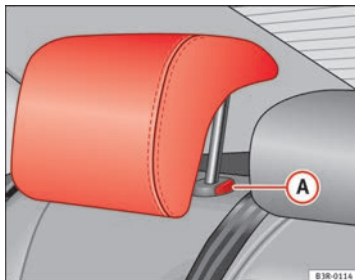

Fig. 5 Outer rear seats:  
Head restraints

#### Raising the head restraint

- Take hold of the sides of the head restraint with both hands.
- Pull the head restraint up as far as it will go.

#### Lowering the head restraint

- Press button **A** ⇒ Fig. 5 and lower the head restraint.

#### Removing the head restraint

- Pull the head restraint up as far as it will go.
- Press button **A** ⇒ Fig. 5 and pull out the head restraint.

#### Fitting the head restraint

- Insert the head restraint in its guides until it clicks into place. Press button **A** and lower the head restraint.



#### WARNING

- Under no circumstances should the rear passengers travel while the head restraints are in the non-use position.
- Do not swap the centre rear head restraint with either of the outer seat rear head restraints.
- Risk of injury in case of an accident!



#### CAUTION

Note the instructions on the adjustment of the head restraints ⇒ page 13. ■

### Examples of incorrect sitting positions

*An incorrect sitting position can lead to severe injuries to occupants.*

Seat belts can provide optimal protection only when the belt webs are properly positioned. Incorrect sitting positions substantially reduce the protective function of seat belts and increase the risk of injury due to incorrect seat belt position. As the driver, you are responsible for all vehicle occupants, especially children.

- Never allow anyone to assume an incorrect sitting position in the vehicle while travelling ⇒ **A**. ▶

The following list contains examples of sitting positions that could be dangerous for all occupants. The list is not complete, but we would like to make you aware of this issue.

**Therefore, whenever the vehicle is in motion:**

- Never stand in the vehicle.
- Never stand on the seats.
- Never kneel on the seats.
- Never tilt your backrest far to the rear.
- Never lean against the dash panel.
- Never lie on the rear bench.
- Never sit on the front edge of a seat.
- Never sit sideways.
- Never lean out of a window.
- Never put your feet out of a window.
- Never put your feet on the dash panel.
- Never put your feet on the surface of a seat.
- Do not allow anyone to travel in the footwell.
- Never travel without wearing the seat belt.
- Do not allow anyone to travel in the luggage compartment.

 **WARNING**

- Any incorrect sitting position increases the risk of severe injuries.
- Sitting in an incorrect position exposes the occupants to severe injuries if airbags are triggered, by striking a passenger who has assumed an incorrect sitting position.
- Before the vehicle moves, assume the proper sitting position and maintain it throughout the trip. Before every trip, instruct your passengers to sit properly and to stay in this position during the trip ⇒ page 10, Proper sitting position for occupants.

## Pedal area

### Pedals

*The operation of all pedals must never be impaired by objects or floor mats.*

- Ensure that you can always press the accelerator, brake and clutch pedals unimpaired to the floor.
- Ensure that the pedals can return unimpaired to their initial positions.

Use only floor mats which leave the pedal area free and can be securely fastened on the footwell.

If a brake circuit fails, the brake pedal must be pressed down thoroughly in order to stop the vehicle.

### Wearing suitable shoes

Always wear shoes which support your feet properly and give you a good feeling for the pedals.

#### WARNING

- Restricting pedal operation can lead to critical situations while driving.
- **Never place objects on the driver footwell. An object could move into the pedal area and impair pedal operation. In the event of a sudden driving or braking manoeuvre, you will not be able to operate the brake, clutch or accelerator pedal. Risk of accident!**

### Floor mats on the driver side

*Only floor mats may be used which can be securely fastened in the footwell and do not impair operation of the pedals.*

- Ensure that the floor mats are securely fastened during the trip and do not obstruct the pedals → .

Only use floor mats which leave the pedals clear and which are secured to prevent them from slipping. You can obtain suitable floor mats from a specialised dealership.

#### WARNING

- **If the pedals are obstructed, an accident may occur. Risk of serious injuries.**
- **Ensure that the floor mats are always securely attached.**
- **Never lay or fit floor mats or other floor coverings over the original floor mats. This would reduce the pedal area and could obstruct the pedals. Risk of accident.**

## Storing objects

### Loading the luggage compartment

*All luggage and other loose objects must be safely secured in the luggage compartment.*

Unsecured objects which shift back and forth could impair the driving safety or driving characteristics of the vehicle by shifting the centre of gravity. ►

- Distribute the load evenly in the luggage compartment.
- Place heavy objects as far forward as possible in the luggage compartment.
- Place the heavy objects first.
- Secure heavy objects to the fitted fastening rings ⇒ page 17.

### WARNING

- **Loose luggage and other objects in the luggage compartment could cause serious injuries.**
- **Always stow objects in the luggage compartment and secure them on the fastening rings.**
- **Use suitable straps to secure heavy objects.**
- **During sudden manoeuvres or accidents, loose objects can be thrown forward, injuring vehicle occupants or passers-by. This increased risk of injury will be further increased if a loose object is struck by an inflating airbag. If this happens, objects can be transformed into “missiles”. Risk of fatal injury.**
- **Please note that the centre of gravity may shift when transporting heavy objects; this may affect the vehicle's handling and lead to an accident. Therefore, it is essential to adjust your speed and driving style accordingly, to avoid accidents.**
- **Never exceed the allowed axle weights or allowed maximum weight. If the allowed axle load or the allowed total weight is exceeded, the driving characteristics of the vehicle may change, leading to accidents, injuries and damage to the vehicle.**
- **Never leave your vehicle unattended, especially when the rear lid is open. Children could climb into the luggage compartment, closing the door behind them; they will be trapped and run the risk of death.**

### WARNING (Continued)

- **Never allow children to play in or around the vehicle. Close and lock all the doors and rear lid when you leave the vehicle. Before you lock the vehicle, make sure that there are no adults or children in the vehicle.**
- **Never transport passengers in the luggage compartment. All passengers must have their seat belt fastened ⇒ page 19.**

### Note

- Air circulation in the vehicle helps reduce fogging of the windows. Used air escapes through ventilation slits in the side trim of the luggage compartment. Ensure that the ventilation slits are never covered.
- Straps for securing the load to the fastening rings are commercially available.

## Fastening rings

*There can be four fastening rings in the luggage compartment for fastening luggage and other objects.*

- Always use suitable and undamaged straps to secure luggage and other objects to the fastening rings ⇒  in Loading the luggage compartment on page 17.
- Pull up the fastening rings to attach the straps.

During a collision or an accident, even small and light objects can build up so much energy that they can cause very severe injuries. The amount of kinetic energy depends on the speed of the vehicle and the weight of the object. The most significant factor, however, is the speed of the vehicle.

Example: An object weighing 4.5 kg is lying unsecured in the vehicle. During a frontal collision at a speed of 50 km/h, this object generates a force corresponding to 20 times its weight. That means that the effective weight ▶

of the object increases to about 90 kg. You can imagine the severity of the injuries which might be sustained if this object strikes an occupant as it flies through the passenger compartment. This increased risk of injury will be further increased if a loose object is struck by an inflating airbag.

**WARNING**

- If pieces of luggage or other objects are secured to the fastening rings with inappropriate or damaged retaining cords, injuries could be sustained in the event of braking manoeuvres or accidents.
- To prevent pieces of luggage or other objects from flying forward, always use appropriate retaining cords which are secured to the fastening rings.
- Never secure a child seat on the fastening rings. ■

## Seat belts

### Brief introduction

#### Before driving: remember your seat belt!

*Wearing a seat belt properly can save your life!*

In this chapter you will learn the importance of wearing seat belts, how they work and how to properly fasten, adjust and wear them.

- Read and consider all the information as well as the warnings in this chapter.



#### WARNING

- If seat belts are worn incorrectly or not at all, the risk of severe injuries increases.
- Properly worn seat belts can reduce severe injuries in case of sudden braking manoeuvres or accidents. For safety reasons, you and your passengers must always wear the seat belts properly while the vehicle is moving.
- Pregnant women or people with physical disabilities must also use seat belts. Like all other passengers, these people can also sustain severe injuries if they are not wearing their seat belts properly.

#### Number of seats

Your vehicle has **five** seats, two in the front and three in the rear. Each seat is equipped with a three-point seat belt.

In some versions, your vehicle is approved **only** for four seats. Two front seats and two rear seats.



#### WARNING

- More people than available seats must never be transported in your vehicle.
- Every passenger in the vehicle must properly fasten and wear the seat belt belonging to his or her seat. Children must be protected with an appropriate child restraint system.

#### Seat belt warning lamp\* 🚨

*The warning lamp acts as a reminder to the driver to fasten the seat belt.*

Before starting the vehicle:

- Fasten your seat belt securely.
- Instruct your passengers to fasten their seat belts properly before driving off.
- Protect children by using a child seat according to the child's height and weight.

After switching on the ignition, the warning lamp 🚨 will remain lit until the driver and front passenger (if applicable) have fastened their seat belts. When the vehicle has reached a certain speed, you will also hear a warning signal and the warning light will flash.

## Why wear seat belts?

### Physical principles of frontal collisions

*In the event of a frontal collision, a large amount of kinetic energy must be absorbed.*

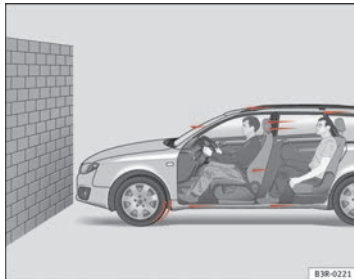

**Fig. 6** Vehicle about to hit a wall: the occupants are not wearing seat belts

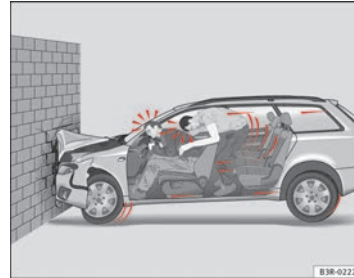

**Fig. 7** The vehicle hits the wall: the occupants are not wearing seat belts

It is easy to explain how the laws of physics work in the case of a head-on collision: When a vehicle starts moving  $\Rightarrow$  Fig. 6, a certain amount of energy known as kinetic energy is produced in the vehicle and its occupants.

The amount of kinetic energy depends on the speed of the vehicle and the weight of the vehicle and its passengers. The higher the speed and the greater the weight, the more energy there is to be released in an accident.

The most significant factor, however, is the speed of the vehicle. If the speed doubles from 25 km/h to 50 km/h, for example, the kinetic energy is multiplied by four.

Because the passengers in our example are not restrained by seat belts, in the case of a head-on collision all of their kinetic energy has to be absorbed at the point of impact  $\Rightarrow$  Fig. 7.

Even at speeds of 30 km/h to 50 km/h, the forces acting on bodies in a collision can easily exceed one tonne (1000 kg). At greater speed these forces are even higher.

Passengers not wearing seat belts are not “attached” to the vehicle. In a head-on collision, they will move forward at the same speed their vehicle  $\blacktriangleright$

was travelling just before the impact. This example applies not only to head-on collisions, but to all accidents and collisions.

### The danger of not using the seat belt

*The general belief that the passengers can protect themselves with their hands in a minor collision is false.*

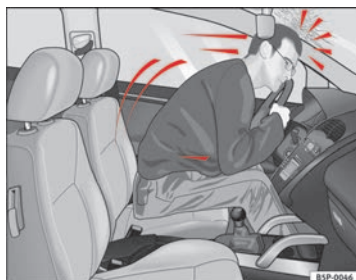

**Fig. 8** A driver not wearing a seat belt is thrown forward violently.



**Fig. 9** The unbelted rear passenger is thrown forward violently, hitting the driver wearing a seat belt.

Even at low speeds the forces acting on the body in a collision are so great that it is not possible to brace oneself with one's hands. In a frontal collision, unbelted passengers are thrown forward and will make violent contact with the steering wheel, dash panel, windscreen or whatever else is in the way → Fig. 8.

The airbag system is not a substitute for seat belts. When triggered, airbags provide only additional protection. All occupants (including the driver) must wear seat belts properly during the trip. This will reduce the risk of severe injuries in the event of an accident – regardless of whether an airbag is fitted for the seat or not.

Note that airbags can be triggered only once. To achieve the best possible protection, the seat belt must always be worn properly so that you will be protected in accidents in which no airbag is deployed.

It is also important for the rear passengers to wear seat belts properly, as they could otherwise be thrown forward violently in an accident. Rear passengers who do not use seat belts endanger not only themselves but also the front occupants → Fig. 9.

### Seat belt protection

*Passengers not wearing seat belts risk severe injuries in the event of an accident.*



**Fig. 10** A driver wearing the seat belt properly is secured by the belt in sharp braking

Properly worn seat belts hold the vehicle occupants in the correct sitting positions and substantially reduce the kinetic energy in the event of an accident. Seat belts also help to prevent uncontrolled movements that could lead to severe injuries. In addition, properly worn seat belts reduce the danger of being thrown from the vehicle.

Passengers wearing their seat belts correctly benefit greatly from the ability of the belts to absorb kinetic energy. The front part of your vehicle and other passive safety features (such as the airbag system) are also designed to absorb the kinetic energy released in a collision. Taken together, all these features reduce the releasing kinetic energy and consequently, the risk of injury.

Our examples describe frontal collisions. Of course, properly worn seat belts substantially reduce the risk of injury in all other types of accidents. This is why it is so important to fasten seat belts before every trip, even when "just driving around the corner".

Ensure that your passengers wear their seat belts as well. Accident statistics have shown that wearing seat belts is an effective means of substantially reducing the risk of injury and improving the chances of survival in a serious accident. Furthermore, properly worn seat belts improve the protection provided by airbags in the event of an accident. For this reason, wearing a seat belt is required by law in most countries.

Although your vehicle is equipped with airbags, the seat belts must be fastened and worn. The front airbags, for example, are only triggered in some frontal accidents. The front airbags will not be triggered during minor frontal collisions, minor side collisions, rear collisions, overturns or accidents in which the airbag trigger threshold value in the control unit is not exceeded.

Therefore, you should always wear your seat belt and ensure that your passengers have fastened their seat belts properly before you drive off! ■

### Safety instructions on using seat belts

*If seat belts are used correctly, they can reduce the risk of injury in an accident.*

- Always wear the seat belt as described in this section.
- Ensure that the seat belts can be fastened at all times and are not damaged. ▶

**WARNING**

- If the seat belts are worn incorrectly or not at all, the risk of severe injuries increases. The optimal protection from seat belts can be achieved only if you use them properly.
- Fasten your seat belt before every trip - even when driving in town. The other passengers must also wear the seat belts at all times, otherwise they run the risk of being injured.
- The seat belt cannot offer its full protection if the seat belt is not positioned correctly.
- Never allow two passengers (even children) to share the same seat belt.
- Keep both feet in the footwell in front of your seat as long as the vehicle is in motion.
- Never unbuckle a seat belt while the vehicle is in motion. Risk of fatal injury.
- The seat belt must never be twisted while it is being worn.
- The seat belt should never lie on hard or fragile objects (such as glasses or pens, etc.) because this can cause injuries.
- Do not allow the seat belt to be damaged or jammed, or to rub on any sharp edges.
- Never wear the seat belt under the arm or in any other incorrect position.
- Loose, bulky clothing (such as an overcoat over a jacket) impairs the proper fit and function of the belts, reducing their capacity to protect.
- The slot in the seat belt buckle must not be blocked with paper or other objects, as this can prevent the latch plate from engaging securely.
- Never use seat belt clips, retaining rings or similar instruments to alter the position of the belt webbing.

**WARNING (Continued)**

- Frayed or torn seat belts or damage to the connections, belt retractors or parts of the buckle could cause severe injuries in the event of an accident. Therefore, you must check the condition of all seat belts at regular intervals.
- Seat belts which have been worn in an accident and stretched must be replaced by a specialised workshop. Renewal may be necessary even if there is no apparent damage. The belt anchorage should also be checked.
- Do not attempt to repair a damaged seat belt yourself. The seat belts must not be removed or modified in any way.
- The belts must be kept clean, otherwise the retractors may not work properly ⇒ page 226.

## Seat belts

### Seat belt adjustment

*The seat belts for the front and rear occupants are locked in to position by a latch.*

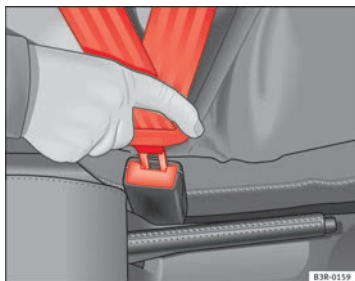

**Fig. 11** Belt buckle and latch plate of seat belt

The seat belt cannot offer its full protection if the seat belt is not positioned correctly.

- Adjust the seat and head restraint correctly.
- To fasten the belt, take hold of the latch plate and pull it slowly across your chest and lap.
- Insert the latch into the buckle for the appropriate seat and push it down until it is securely locked with a click ⇒ **Fig. 11**.
- Pull the belt to ensure that the latch plate is securely engaged in the buckle.

The seat belts are equipped with an automatic retractor on the shoulder strap. Full freedom of movement is permitted when the shoulder belt is pulled slowly. However, during sudden braking, during travel in steep areas or bends and during acceleration, the automatic retractor on the shoulder belt is locked.

The automatic belt retractors on the front seats are fitted with seat belt tensioners ⇒ page 28.



#### WARNING

- An incorrectly worn seat belt can cause severe injuries in the event of an accident.
- The seat belts offer best protection only when the backrests are in an upright position and the seat belts have been fastened properly.
- Never put the latch plate in the buckle of another seat. If you do this, the seat belt will not protect you properly and the risk of injury is increased.
- If an occupant is incorrectly belted in, the belt cannot protect him or her properly. An incorrectly positioned seat belt can cause extremely severe injuries.

## Seat belt position

Seat belts offer their maximum protection only when they are properly positioned.

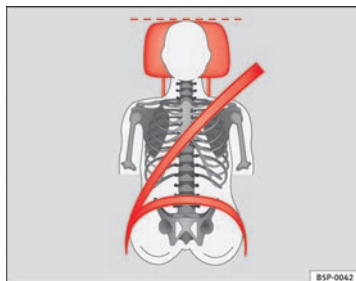

Fig. 12 Correct seat belt and head restraint positions, viewed from front

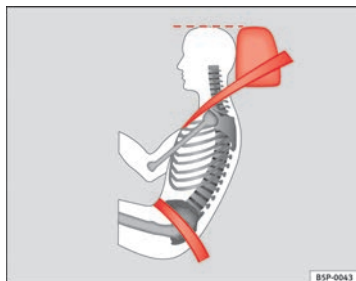

Fig. 13 Correct seat belt and head restraint positions, viewed from side

The following features are available to adjust the seat belt in the shoulder region:

- belt height adjustment for the front seats.
- front seat height adjustment\*.



### WARNING

- An incorrectly worn seat belt can cause severe injuries in the event of an accident.
- The shoulder part of the seat belt must lie on the centre of the shoulder, never across the neck. The seat belt must lie flat and snugly on the torso ⇒ Fig. 12.
- The lap part of the seat belt must lie across the pelvis, never across the stomach. The seat belt must lie flat and snugly on the pelvis ⇒ Fig. 13. Pull the belt tight if necessary to take up any slack.
- Read and observe the warnings ⇒ page 22.

### Pregnant women must also fasten their seat belts properly

*The best protection for the unborn child is for the mother to wear the seat belt properly at all times during the pregnancy.*



**Fig. 14** Positioning seat belts during pregnancy

The seat belt provides maximum protection only when the seat belt is properly positioned ⇒ page 25.

- Adjust the front seat and head restraint correctly ⇒ page 10.
- Holding the latch plate, pull the belt evenly across your chest and as low as possible over the pelvis ⇒ Fig. 14.
- Insert the latch plate into the buckle for the appropriate seat and push it down until it is securely locked with a click ⇒ ⚠.
- Pull the belt to ensure that the latch plate is securely engaged in the buckle.

### **⚠ WARNING**

- An incorrectly worn seat belt can cause severe injuries in the event of an accident.
- For pregnant women, the lap part of the seat belt must lie as low as possible over the pelvis, never across the stomach, and always lie flat so that no pressure is exerted on the abdomen.
- Read and observe the warnings ⇒ page 22.

### Seat belt release

*The seat belt must not be unfastened until the vehicle has come to a standstill.*

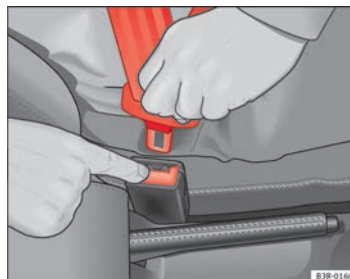

**Fig. 15** Removing latch plate from buckle

- Press the red button on the belt buckle ⇒ Fig. 15. The latch plate is released and springs out ⇒ ⚠.

- Guide the belt back by hand so that it rolls up easily and the trim is not damaged

### WARNING

Never unbuckle a seat belt while the vehicle is in motion. If you do, you increase the risk of sustaining severe or fatal injuries.

## Seat belt height adjustment

Seat belt height adjusters can be used to adjust the height of the shoulder area of the seat belt.

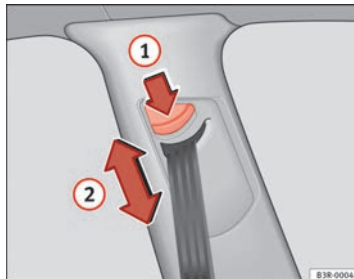

Fig. 16 Belt height adjuster

The belt height adjuster can be lowered by keeping the button pressed down at the same time.

- Press button ⇒ Fig. 16 ① to adjust the belt height.

- Take hold of the top guide fitting and slide it up or down so that the shoulder part of the seat belt is positioned roughly midway over the shoulder, although **it must never rest against the neck** ⇒ Fig. 16 ② ⇒ ⚠ in Seat belt position on page 25.
- After adjusting, pull the belt sharply to check that the catch on the guide fitting is engaged securely.

### Note

It is also possible to adjust the height of the front seats to obtain the best position for the front seat belts.

## Incorrectly fastened seat belts

*Incorrectly worn seat belts can cause severe or even mortal injuries.*

Seat belts can provide optimal protection only if the belt web is properly worn. The seat belts must be fastened exactly in the order described in this chapter. An incorrect sitting position impairs substantially the protection a seat belt offers and can lead to severe or fatal injuries. The risk of severe or fatal injuries is especially increased when a deploying airbag strikes an occupant who has assumed an incorrect sitting position. As the driver, you are responsible for all vehicle occupants, especially children. Therefore:

- Never allow anyone to wear the seat belt incorrectly while the vehicle is moving ⇒ ⚠.

**WARNING**

- An incorrectly worn seat belt increases the risk of severe injuries.
- Before every trip, instruct your passengers to adjust their seat belts properly and to wear them for the whole journey.
- Read and always observe information and warnings concerning the use of seat belts ⇒ page 22.

## Seat belt tensioners

### Function of the seat belt tensioner

*During a frontal collision, the seat belts on the front seats are retracted automatically.*

The seat belts for the front occupants are equipped with belt tensioners. Sensors will trigger the belt tensioners during severe head-on, lateral and rear collisions only if the seat belt is being worn. This retracts and tightens the seat belts, reducing the forward motion of the occupants.

The seat belt tensioner can be triggered only once.

The seat belt tensioners will not be triggered in the event of a light frontal, side or rear collision, if the vehicle overturns or in situations where no large forces act on the front, side or rear of the vehicle.

**Note**

- If the seat belt tensioners are triggered, a fine dust is produced. This is normal and it is not an indication of fire in the vehicle.
- The relevant safety requirements must be observed when the vehicle or components of the system are scrapped. Specialised workshops are familiar with these regulations, which are also available to you.

### Service and disposal of belt tensioners

The belt tensioners are components of the seat belts that are installed in the seats of your vehicle. If you work on the belt tensioners or remove and install parts of the system when performing other repair work, the seat belt may be damaged. The consequence may be that, in the event of an accident, the belt tensioners function incorrectly or not at all.

So that the effectiveness of the seat belt tensioner is not reduced and that removed parts do not cause any injuries or environmental pollution, regulations, which are known to the specialised workshops, must be observed.

**WARNING**

- Improper use or repairs not carried out by qualified mechanics increase the risk of severe or fatal injuries. The belt tensioners may fail to trigger or may trigger in the wrong circumstances.
- Never attempt to repair, adjust, remove or install parts of the belt tensioners or seat belts.
- The seat belt tensioner, seat belt and automatic retractor cannot be repaired.
- Any work on the belt tensioners and seat belts, including the removal and refitting of system parts in conjunction with other repair work, must be performed by a specialised workshop only.
- The belt tensioners will only provide protection for one accident and must be changed if they have been activated.

## Airbag system

### Brief introduction

#### Why wear a seat belt and assume the correct sitting position?

*For the inflating airbags to achieve the best protection, the seat belt must always be worn properly and the correct sitting position must be assumed.*

For your own safety and the safety of the passengers, please ensure the following before driving:

- Always wear the seat belt properly ⇒ page 19.
- Adjust the driver seat and the steering wheel correctly ⇒ page 10.
- Adjust the front passenger seat correctly ⇒ page 11.
- Adjust the head restraint correctly ⇒ page 13.
- Use the correct child restraint system to protect children in your vehicle ⇒ page 47.

The airbag is deployed at high speed in fractions of a second. If you have an incorrect seating position at the time the airbag is deployed, it could cause you critical injuries. Therefore, it is essential that all passengers in the vehicle assume a correct sitting position while travelling.

A sharp braking before an accident may cause a passenger not wearing a seat belt to be thrown forward into the area of the deploying airbag. In this

case, the inflating airbag may inflict critical or fatal injuries on the occupant. This also applies to children.

Always maintain the greatest possible distance between yourself and the front airbag. This way, the front airbags can completely deploy when triggered, providing their maximum protection.

The most important factors that will trigger an airbag are: the type of accident, the angle of collision and the speed of the vehicle.

Whether the airbags are triggered depends primarily on the vehicle deceleration rate resulting from the collision and detected by the control unit. If the vehicle deceleration occurring during the collision and measured by the control unit remains below the specified reference values, the front, side and/or curtain airbag will not be triggered. Take into account that the visible damage in a vehicle involved in an accident, no matter how serious, is not a determining factor for the airbags to have been triggered.



#### WARNING

- **Wearing the seat belt incorrectly or assuming an incorrect sitting position can lead to critical or fatal injuries.**
- **All occupants, including children, who are not properly belted can sustain critical or fatal injuries if the airbag is triggered. Children up to 12 years old should always travel on the rear seat. Never transport children in the vehicle if they are not restrained or the restraint system is not appropriate for their age, size or weight.**
- **If you are not wearing a seat belt, if you lean forward or to the side while travelling or assume an incorrect sitting position, there is a substantially increased risk of injury. This increased risk of injury will be further increased if you are struck by an inflating airbag.**

 **WARNING (Continued)**

- To reduce the risk of injury from an inflating airbag, always wear the seat belt properly ⇒ page 19.
- Always adjust the front seats properly.

### The danger of fitting a child seat on the front passenger seat

*Rear-facing child seats must never be used on the front passenger seat when the front passenger airbag is enabled.*

The front passenger airbag is a serious risk for a child if it is activated. The front passenger seat is life threatening to a child if he/she is transported in a rear-facing child seat. Children up to 12 years old should always travel on the rear seat.

If a rear-facing child seat is secured to the front passenger seat, an inflating airbag can strike it with such force that it can cause critical or fatal injuries.

Therefore we strongly recommend you to transport children on the rear seats. That is the safest place for children in the vehicle. Alternatively, the front passenger airbag can be disabled with a key-operated switch ⇒ page 45. When transporting children, use a child seat appropriate to the age and size of each child ⇒ page 47.

For those vehicles that do not include a key lock switch to disconnect the airbag, the vehicle must be taken to a Technical Service.

 **WARNING**

- If a child seat is secured to the front passenger seat, the risk to the child of sustaining critical or fatal injuries in the event of an accident increases.
- Never secure a rear-facing child seat to the front passenger seat if the front passenger airbag is enabled. The child can suffer critical or fatal injuries if the front passenger airbag is triggered.
- An inflating front passenger airbag can strike the rear-facing child seat and hurl it with great force against the door, the roof or the backrest.
- If, under special circumstances, it is necessary to transport a child in a rear-facing child seat on the front passenger seat, it is absolutely essential that you observe the following safety measures:
  - Deactivate the front passenger airbag ⇒ page 45, Deactivating airbags.
  - The child seat must be approved by the child seat manufacturer for use on a front passenger seat with front or side airbag.
  - Follow the installation instructions given by the child seat manufacturer and observe the safety instructions ⇒ page 47, Child safety.
  - Before properly installing the child seat, push the front passenger seat completely backwards so that the greatest possible distance to the front passenger airbag is ensured.
  - Ensure that no objects prevent the front passenger seat from being pushed completely back.
  - The backrest of the front passenger seat must be in an upright position.

## Warning lamp for airbag and seat belt tensioner

*This warning lamp monitors the airbag and seat belt tensioner system.*

The warning lamp monitors all airbags and seat belt tensioners in the vehicle, including control units and wiring connections.

### Monitoring of airbag and belt tensioner system

Both the airbag and belt tensioner systems operation is constantly monitored electronically. The warning lamp  will light every time the ignition is switched on until you attach your seatbelt.

**The system must be checked when the warning lamp  :**

- does not light up when the ignition is switched on,
- turns off and then lights up again after the ignition is switched on,
- lights up or flashes while the vehicle is moving.

In the event of a malfunction, the warning lamp remains on continuously. Have the system inspected immediately by a specialised workshop.

If any of the airbags are de-activated by the Technical Service, the indicator lights for several seconds more after the verification and will turn off if there is no fault.

### WARNING

- If there is a malfunction, the airbag and belt tensioner system cannot properly perform its protective function.
- If a malfunction occurred, have the system checked immediately by a specialised workshop. Otherwise, in the event of an accident, the airbag system and belt tensioners may not be triggered, or may not be triggered correctly.

## Repairs, maintenance and disposal of airbags

The parts of the airbag system are installed in various places in your vehicle. If work is carried out on the airbag system or parts have to be removed and fitted on the system when performing other repair work, parts of the airbag system may be damaged. In the event of an accident this could cause the airbag to inflate incorrectly or not inflate at all.

The relevant safety requirements must be observed when the vehicle or components of the airbag are **scrapped**. Specialised workshops and vehicle disposal centres are familiar with these requirements.

### WARNING

- If repairs are not carried out by a professional, or if the airbags are used incorrectly, the risk of severe or fatal injuries is increased. The airbags may fail to inflate, or could inflate in the wrong circumstances.
- Do not cover or stick anything on the steering wheel hub or the surface of the airbag unit on the passenger side of the dash panel, and do not obstruct or modify them in any way.
- It is important not to attach any objects such as cup holders or telephone mountings to the surfaces covering the airbag units.
- To clean the steering wheel or dash panel, you may use only a dry or a water-moistened cloth. Never clean the dash panel and the airbag module surface with cleaners containing solvents. Solvents cause the surface to become porous. If the airbag triggered, plastic parts could become detached and cause injuries.
- Never attempt to repair, adjust, remove or install parts of the airbag system.

 **WARNING (Continued)**

- Any work on the airbag system or removal and installation of the airbag components for other repairs (such as repairs to the steering wheel) should be performed only by a specialised workshop. Specialised workshops have the necessary tools, repair information and qualified personnel.
- We strongly recommend you to go to a specialised workshop for all work on the airbag system.
- Never attempt to alter the front bumper or the body.
- The airbags provide protection for just one accident; replace them once they have deployed.

**For the sake of the environment**

The airbags, which are a special type of waste, must be disposed of through an authorised service, because they contain pyrotechnic elements. ■

## Front airbags

### Description of front airbags

*The airbag system is not a substitute for the seat belts.*



**Fig. 17** Driver airbag in the steering wheel and knee airbag in the dash panel

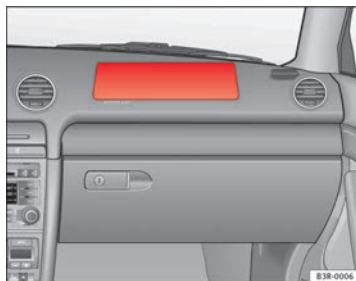

**Fig. 18** Front passenger airbag located in dash panel

The front airbag for the driver is located in the steering wheel ⇒ Fig. 17 and the airbag for the front passenger is located in the dash panel ⇒ Fig. 18. Airbags are identified by the word "AIRBAG". On the driver side, the knee airbag\* is found in the footwell lining, under the instrument panel.

In conjunction with the seat belts, the front airbag system gives the front occupants additional protection for the head and chest in the event of a severe frontal collision ⇒ page 36, Safety notes on the front airbag system.

In addition to their normal function of restraining the occupants, the seat belts also hold the driver and front passenger in a position where the airbags can provide maximum protection in a frontal collision.

The airbag system is not a substitute for seat belts, but it is an integral part of the vehicle's overall passive safety system. Please bear in mind that the airbag system can only work effectively when the occupants are wearing their seat belts correctly and have adjusted the head restraints properly. Therefore, it is most important to wear the seat belts at all times, not only because this is required by law in most countries, but also for your safety ⇒ page 19, Brief introduction.

#### The main parts of the front airbag system are:

- an electronic control and monitoring system (control unit)
- the two front airbags (airbag with gas generator) for the driver and front passenger,
- a knee airbag\* for the driver,
- a warning lamp  on the instrument panel ⇒ page 31

The airbag system operation is monitored electronically. The airbag warning lamp will light up for a few seconds every time the ignition is switched on (self-diagnosis).

#### There is a fault in the system if the warning lamp :

- does not light up when the ignition is switched on ⇒ page 31
- turns off and then lights up again after the ignition is switched on,
- lights up or flashes while the vehicle is moving. ▶

The front airbag system will not be triggered if:

- the ignition is switched off
- there is a minor frontal collision,
- there is a side collision,
- there is a rear-end collision
- the vehicle turns over

**WARNING**

- The seat belts and airbags can only provide maximum protection if the occupants are seated correctly → page 10, Proper sitting position for occupants.
- If a fault has occurred in the airbag system, have the system checked immediately by a specialised workshop. Otherwise, during a frontal collision the system may fail to trigger, or not trigger correctly.

### Operation of front airbags

*Inflated airbags reduce the risk of head or chest injury.*

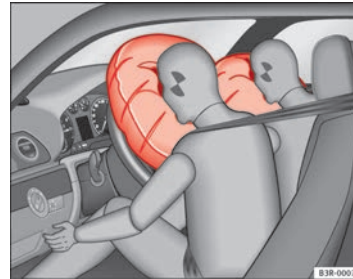

**Fig. 19** Inflated front airbags

The airbag system is designed so that the airbags for the driver and front passenger are triggered in a severe frontal collision.

In certain types of accident the front, curtain and side airbags may be triggered together.

When the system is triggered, the airbags fill with a propellant gas and deploy in front of the driver and front passenger → Fig. 19. The fully deployed airbags cushion the forward movement of the front occupants and help to reduce the risk of injury to the head and the upper part of the body.

The special design of the airbag allows the controlled escape of the propellant gas when an occupant puts pressure on the bag. Thus, the head and chest are surrounded and protected by the airbag. After the collision, the airbag deflates sufficiently to allow visibility.

The airbags deploy extremely rapidly, within thousandths of a second, to provide additional protection in the event of an accident. A fine dust may ▶

develop when the airbag deploys. This is normal and it is not an indication of fire in the vehicle. ■

### Airbag covers when the frontal airbags are triggered

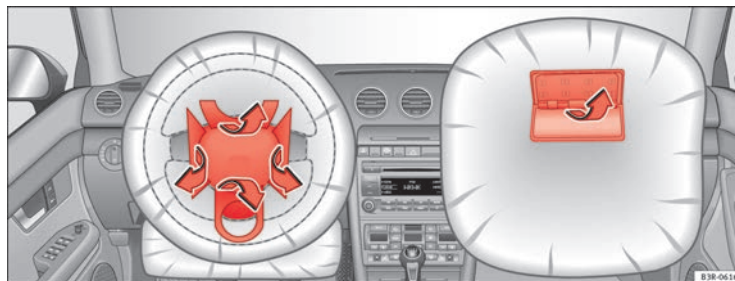

Fig. 20 Airbag covers reacting when the front airbags are triggered

The airbag covers fold out of the steering wheel or dash panel when the driver and front passenger airbags are triggered ⇒ Fig. 20. The airbag covers remain connected to the steering wheel or the dash panel. ■

### Safety notes on the front airbag system

*If you use airbags correctly, they can considerably reduce the risk of injury in many kinds of accident.*

#### WARNING

- It is important for the driver and front passenger to keep a distance of at least 25 cm from the steering wheel and dash panel. If the minimum distance is not observed then the airbags do not correctly protect the vehicle occupants; risk of fatal injuries! In addition, the front seats and head restraints must always be positioned correctly for the height of the occupant.
- If you are not wearing a seat belt, if you lean forward or to the side while travelling or assume an incorrect sitting position, there is a substantially increased risk of injury. This increased risk of injury will be further increased if you are struck by an inflating airbag.
- Never let a child travel on the front seat without an appropriate restraint system. If the airbag is triggered in an accident, children can sustain serious or fatal injuries from the airbag as it inflates ⇒ page 47, Child safety.
- The deployment space between the front passengers and the airbags must not in any case be occupied by other passenger, pets and objects.
- The airbags provide protection for just one accident; replace them once they have deployed.
- It is also important not to attach any objects such as cup holders or telephone mountings to the surfaces covering the airbag units.
- Do not attempt to modify components of the airbag system in any way.

### Knee airbag\*

#### Description of the knee airbag

*The airbag system provides additional protection to front seat passengers if they are properly secured.*

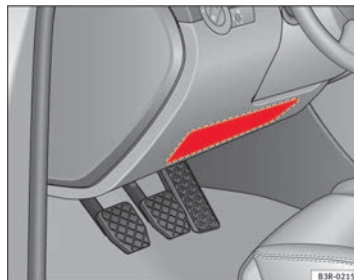

**Fig. 21** Driver knee airbag

The knee airbag for the driver is located in the dash panel underneath the steering wheel ⇒ Fig. 21.

The knee airbag offers additional protection to the driver's knees and upper and lower thigh areas as a supplement to the seat belts.

If the front airbags deploy, the knee airbag also deploys in severe frontal collisions ⇒ page 34

Besides their normal safety function, seat belts help keep the driver in position in case of a frontal collision so that the airbags can provide protection.

The airbag system is not a substitute for seat belts. It is, on the other hand, part of the overall occupant safety system of your vehicle. Always remember ►

that the airbag system can only help to protect you if you are wearing your seat belt and wearing it properly.

Remember too that airbags will deploy only once and only in certain kinds of accidents - your seat belts are always there to offer protection in those accidents in which airbags are not supposed to deploy or when they have already deployed, for example when your vehicle strikes or is struck by another after the first collision.

This is just one of the reasons why an airbag is not a substitute for the seat belt. The airbag system works most effectively when used with the seat belts. Therefore, always wear your seat belts correctly.

It is important to remember that while the airbag system is designed to reduce the possibility of serious injuries, other injuries, for example, swelling, bruising, and minor abrasions can also be associated with airbags.

#### The knee airbag system basically consists of:

- The electronic control module
- One inflatable airbag (airbag and gas generator) for the driver
- An airbag indicator light on the instrument panel

#### The knee airbag system will not be triggered:

- if the ignition is switched off
- in frontal collisions when the deceleration measured by the control unit is too low
- in side collisions
- in rear-end collisions
- in rollovers
- in the event of a system malfunction (hazard warning lights/turn signals illuminated) ⇒ page 67.

#### WARNING

- Seat belts and the airbag system can only provide protection when occupants are in the proper seating position.
- If the airbag indicator light comes on when the vehicle is being used, have the system inspected immediately by your Technical Service. The airbag may not work properly when the vehicle acceleration in a side collision is high enough to deploy the airbag. See also ⇒ page 67.

### How knee airbags work

*The risk of injury to the leg area is reduced by fully deployed knee airbags.*



**Fig. 22** Inflated airbags protect in a frontal collision.

The knee airbag system has been designed so that the airbag for the driver is deployed in certain but not all frontal collisions.

If the front airbag deploys, the knee airbag also deploys in severe frontal collisions.

When the system is deployed, the airbag starts to fill with a propellant gas, and inflates between the lower part of the dash panel and the driver

⇒ Fig. 22.

Although they are not a soft pillow, they can cushion the impact and in this way help to reduce the risk of injury to lower limbs.

All this takes place instantaneously, so fast that many people do not even realise that the airbags have deployed. The airbags also inflate with a great deal of force and it is important for occupant safety that nothing should be in their way when they deploy.

Fully inflated airbags in combination with properly worn seat belts slow down and limit the occupant's forward movement and help to reduce the risk of injury.

### Important safety notes on the knee airbag system

#### *Airbags are only additional safety*

Always wear seat belts correctly and drive in a proper seated position. There is a lot of information that you and your passengers should know and do so that the seat belts and airbags can provide additional protection.



#### WARNING

An inflating knee airbag can cause serious injuries. Wearing seat belts incorrectly and improper seating positions increase the risk of serious personal injury and death whenever a vehicle is being used.

- The airbag system cannot protect you properly if you are seated too close to any of the airbag locations. When adjusting the seat positions, it is important for the driver to keep the upper body and knees at the following minimum safety distances:
  - 25 cm between the chest and the steering wheel/dash panel.
  - 10 cm between the knees and the lower part of the dash panel.
- The risk of personal injury increases if you lean forward or to the side, or if the seat is improperly positioned and you are not wearing your seat belt. The risk increases even more should the airbag deploy.
- Always make sure that the knee airbag can inflate without interference. Objects between yourself and the airbag can increase the risk of injury in an accident by interfering with the way the airbag deploys or by being thrust into you as the airbag deploys.
  - No objects of any kind should be carried in the footwell area in front of the driver's seat. Bulky objects (shopping bags, for example) can hinder or prevent proper deployment of the airbag. Small objects can be thrown through the vehicle if the airbag deploys and injure you or your passengers.
- Make sure there are no cracks, deep scratches or other damage in the area of the dash panel where the knee airbag is located.
- If children are incorrectly seated, their risk of injury increases in the case of an accident ⇒ page 47.

## Side airbags\*

### Description of side airbags

*The airbag system is not a substitute for the seat belts.*

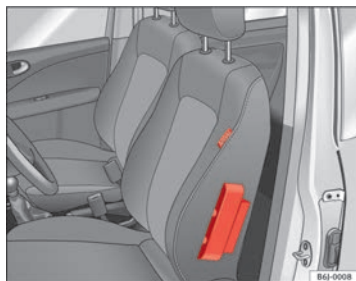

**Fig. 23 Side airbag in driver seat**

The front side airbags are located in the driver seat and front passenger seat backrests ⇒ Fig. 23. The rear side airbags\* are located in the rear wheel housing lining. The locations are identified by the text "AIRBAG" in the upper region of the backrests and in the rear wheel housing lining.

Together with the seat belts, the side airbag system gives the front seat occupants additional protection for the upper body in the event of a severe side collision ⇒ page 41, Safety notes on the operation of the side airbag system.

In a side collision, the side airbags reduce the risk of injury to passengers on the front seats to the areas of the body facing the impact. In addition to their normal function of protecting the occupants in a collision, the seat belts also hold the passengers in the front seats and the outer rear seats in a position where the side airbags can provide maximum protection.

The airbag system is not a substitute for seat belts, but it is an integral part of the vehicle's overall passive safety system. Please bear in mind that the airbag system can only work effectively when the occupants are wearing their seat belts. Therefore, it is most important to wear the seat belts at all times, not only because this is required by law in most countries, but also for your safety ⇒ page 19, Brief introduction.

#### The side airbag system will not be triggered if:

- the ignition is switched off
- there is a minor side collision
- there is a frontal collision
- there is a rear-end collision
- the vehicle turns over

#### The main parts of the airbag system are:

- an electronic control and monitoring system (control unit)
- The front side airbags in the backrests of the front seats and the rear side airbags in the lining of the rear wheel housing
- a warning lamp  on the instrument panel ⇒ page 31

The airbag system operation is monitored electronically. The airbag warning lamp will light up for approx. 4 seconds every time the ignition is switched on (self-diagnosis).



#### WARNING

- In a side collision, the side airbags will not work, if the sensors do not correctly measure the pressure increase on the interior of the doors, due to air escaping through the areas with holes or openings in the door panel.
- Never drive the vehicle if the interior panels have been removed.
- Never drive if the interior door panels have been removed or if the panels have not been correctly fitted.

**⚠ WARNING (Continued)**

- Never drive the vehicle if the loudspeakers in the door panels have been removed, unless the holes left by the loudspeakers have been correctly closed.
- Always check that the openings are closed or covered if loudspeakers or other equipment are fitted in the interior door panels.
- Any work carried out to the doors should be made in a specialised workshop.
- The seat belts and airbags can only provide maximum protection if the occupants are seated correctly ⇒ page 10, Proper sitting position for occupants.
- If a fault has occurred in the airbag system, have the system checked immediately by a specialised workshop. Otherwise, during a side collision, the system may fail to trigger, or not trigger correctly.

## Operation of side airbags

*Inflated airbags can reduce the risk of head or chest injury in many side impact collisions.*

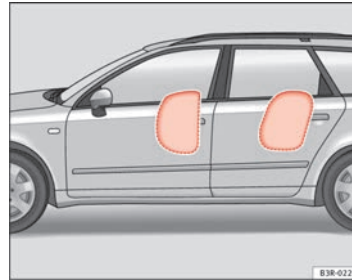

**Fig. 24 Inflated side airbag on left side of vehicle**

In some **side collisions**, the side airbag is triggered on the impact side of the vehicle ⇒ Fig. 24.

In certain types of accident the front, curtain and side airbags may be triggered together.

When the system is triggered, the airbag is filled with propellant gas.

The airbags deploy extremely rapidly, within thousandths of a second, to provide additional protection in the event of an accident. A fine dust may develop when the airbag deploys. This is normal and it is not an indication of fire in the vehicle.

The fully deployed airbags cushion the movement of the occupants of the front seats and the outer rear seats and help to reduce the risk of injury to the upper body. ▶

The special design of the airbag allows the controlled escape of the propellant gas when an occupant puts pressure on the bag. Thus, the head and chest are surrounded and protected by the airbag.

### Safety notes on the operation of the side airbag system

*If airbags are used correctly, they can considerably reduce the risk of injury in side impact collisions.*

#### WARNING

- If you do not wear a seat belt, if you lean forward, or are not seated correctly while the vehicle is in motion, you are at a greater risk of injury if the side airbag system is triggered in an accident.
- In order for the side airbags to provide their maximum protection, the prescribed sitting position must always be maintained with seat belts fastened while travelling.
- Occupants of the outer seats must never carry any objects or pets in the deployment space between them and the airbags, or allow children or other passengers to travel in this position. It is also important not to attach any accessories (such as cup holders) to the doors. This would impair the protection offered by the side airbags.
- The built-in coat hooks should be used only for lightweight clothing. Do not leave any heavy or sharp-edged objects in the pockets.
- Great forces, such as hard blows or kicks, must not be exerted upon the backrest bolster because the system may be damaged. In this case, the side airbags would not be triggered.
- Under no circumstances should protective covers be fitted over seats with side airbags unless the covers have been approved for use in your vehicle. Because the airbag is triggered from the side of the backrest, the

#### WARNING (Continued)

use of non-approved seat covers would obstruct the side airbag, seriously reducing the airbag's effectiveness ⇒ page 228, Accessories, replacement of parts and modifications.

- Any damage to the original seat upholstery or around the seams of the side airbag units must be repaired immediately by a specialised workshop.
- The airbags provide protection for just one accident; replace them once they have deployed.
- When children assume an incorrect sitting position, they expose themselves to an increased risk of injury in the event of an accident. This is particularly the case if the child is travelling on the front passenger seat and the airbag system is triggered in an accident; this could have critical consequences including serious injury or death ⇒ page 47, Child safety.
- Any work on the side airbag system or removal and installation of the airbag components for other repairs (such as removal of the front seat) should only be performed by a specialised workshop. Otherwise, faults may occur during the airbag system operation.
- Do not attempt to modify components of the airbag system in any way.
- The side and head airbags are managed through sensors located in the interior of the front doors. To ensure the correct functioning of the side and head airbags neither the doors nor the door panels should be modified in any way (e.g. fitting loudspeakers). If the front door is damaged, the airbag system may not work correctly. All work carried out on the front door must be made in a specialised workshop.

## Curtain airbags

### Description of curtain airbags

*The airbag system is not a substitute for the seat belts.*

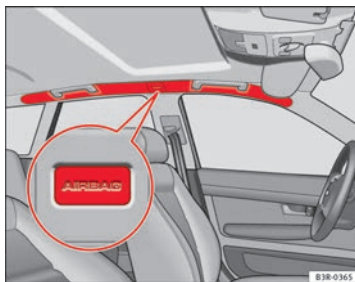

**Fig. 25** Location of head airbags on the left side of the vehicle

The curtain airbags are located on both sides in the interior above the doors ⇒ Fig. 25 and are identified with the text “AIRBAG”.

In conjunction with the seat belts, the curtain airbag system gives the occupants additional protection for the head and upper body in the event of a severe side collision ⇒ page 43, Safety notes on the operation of the curtain airbag system.

The airbag system is not a substitute for seat belts, but it is an integral part of the vehicle's overall passive safety system. Please bear in mind that the airbag system can only work effectively when the occupants are wearing their seat belts correctly and have adjusted the head restraints properly. Therefore, it is most important to wear the seat belts at all times, not only because this is required by law in most countries, but also for your safety ⇒ page 19, Brief introduction.

**The main parts of the curtain airbag system are:**

- an electronic control and monitoring system (control unit)
- the curtain airbags (airbags with gas generator) for the driver, front passenger and passengers on the rear seats,
- a warning lamp  on the instrument panel ⇒ page 31

The airbag system operation is monitored electronically.

**The curtain airbag system will not be triggered if:**

- the ignition is switched off
- there is a frontal collision
- there is a rear-end collision
- the vehicle turns over
- there is a minor side collision



#### WARNING

**If a fault has occurred in the airbag system, have the system checked immediately by a specialised workshop. Otherwise there is a danger that during a collision, the system may fail to trigger, or not trigger correctly.**

## Operation of curtain airbags

*Fully inflated airbags reduce the risk of head or chest injury in a side collision.*



**Fig. 26** Deployed curtain airbags

During some **side collisions** the curtain airbag is triggered on the impact side of the vehicle ⇒ Fig. 26.

In certain types of accident the front, side and curtain airbags may be triggered together.

When the system is triggered, the airbag is filled with propellant gas. In the process, the curtain airbag covers the side windows and door pillars.

The airbags deploy extremely rapidly, within thousandths of a second, to provide additional protection in the event of an accident. A fine dust may develop when the airbag deploys. This is normal and it is not an indication of fire in the vehicle.

The fully deployed airbags cushion the movement of the front occupants and help to reduce the risk of injury to the upper body.

The special design of the airbag allows the controlled escape of the propellant gas when an occupant puts pressure on the bag. Thus, the head and chest are surrounded and protected by the airbag.

## Safety notes on the operation of the curtain airbag system

*If you use airbags correctly, they can considerably reduce the risk of injury in many kinds of accident.*

### WARNING

- In order for the side airbags to provide their maximum protection, the prescribed sitting position must always be maintained with seat belts fastened while travelling.
- For safety reasons, the curtain airbag must be disconnected in those vehicles fitted with a passenger compartment separation screen. See a Technical Service to make this adjustment.
- There must be no other persons, animals or objects between the occupants of the outer seats and the deployment space of the curtain airbags so that the curtain airbag can deploy without restriction and provide the greatest possible protection. Therefore, sun blinds which have not been expressly approved for use in your vehicle may not be attached to the side windows ⇒ page 228, Accessories, replacement of parts and modifications.
- The built-in coat hooks should be used only for lightweight clothing. Do not leave any heavy or sharp-edged objects in the pockets. Please, do not hang the clothes on coat hangers.
- The airbags provide protection for just one accident; replace them once they have deployed.

 **WARNING (Continued)**

- Any work on the curtain airbag system or removal and installation of the airbag components for other repairs (such as removal of the roof lining) should only be performed by a specialised workshop. Otherwise, faults may occur during the airbag system operation.
- Do not attempt to modify components of the airbag system in any way.
- The side and head airbags are managed through sensors located in the interior of the front doors. To ensure the correct functioning of the side and head airbags neither the doors nor the door panels should be modified in any way (e.g. fitting loudspeakers). If the front door is damaged, the airbag system may not work correctly. All work carried out on the front door must be made in a specialised workshop.

## Deactivating airbags

### Front passenger airbag deactivation

If you fit a rear-facing child seat to the front passenger seat, the front passenger airbag must be de-activated.

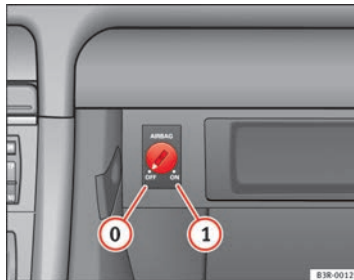



Fig. 27 In the glove compartment: switch for activating and deactivating the front passenger airbag



Fig. 28 Warning lamp for deactivated passenger airbag in centre console

When the passenger airbag is **deactivated**, only the front airbag is deactivated. All the other airbags in the vehicle remain activated.

### Deactivating the front passenger airbag

- Switch the ignition off.
- Turn the ignition key in the key-operated switch in the glove compartment to position ① **OFF** ⇒ Fig. 27.
- Check that the warning lamp “OFF” on the instrument panel ⇒ Fig. 28 remains lit when the ignition is switched on ⇒ .

### Activating the front passenger airbag

- Switch the ignition off.
- Turn the ignition key in the key-operated switch in the glove compartment to position ① **ON** ⇒ Fig. 27.
- Check that the warning lamp on the instrument panel ⇒ Fig. 28 *does not* light up when the ignition is switched on ⇒  ▶

**WARNING**

- The driver is responsible for the proper position of the key-operated switch.
- You should only deactivate the front passenger airbag when, in exceptional cases, you have to use a rear-facing child seat on the front passenger seat ⇒ page 47, Child safety.
- Never install a child seat facing backwards on the front passenger seat unless the front passenger airbag has been disabled. Otherwise, there is a risk of death. If under exceptional circumstances it is necessary to transport a child in a rear-facing child seat on the front passenger seat, you must always disable the front passenger airbag.
- As soon as the child seat is no longer needed on the front passenger seat, enable the front passenger airbag again.
- Only deactivate the passenger airbag when the ignition is off, otherwise a fault may occur in the airbag system, which could cause the airbag to not deploy properly or not deploy at all.
- When the passenger airbag is deactivated, if the warning lamp AIR-BAG OFF is not continuously lit up, there may be a fault in the airbag system:
  - Have the airbag system inspected immediately by a specialised workshop.
  - Do not use a child seat on the front passenger seat! The front passenger airbag could be triggered despite the fact that there is a fault in the system and, as a result, a child could sustain serious or fatal injuries.
  - It is unpredictable whether the front passenger airbag will deploy in the event of an accident. Warn all your passengers of this.
- When using the ignition key to activate/deactivate the front passenger airbag, only the front passenger airbag will be activated/deactivated. The side airbag and head airbag on the passenger side will remain active.

## Child safety

### Brief introduction

#### Introduction

*Statistics show that children are generally safer on the rear seat than on the front passenger seat.*

For safety reasons we recommend that children under 12 years of age travel on the rear seats. Depending on their age, height and weight, children travelling on the rear seat must use a child seat or a seat belt. It is advisable that children always travel in the rear seats, the rear central position being the safest seat, since the risk of injuries in a side collision is diminished.

The physical laws involved and the forces acting in a collision apply also to children. → page 20, Why wear seat belts?. But unlike adults, children do not have muscle and bone structures fully developed. This means that children are subject to a greater risk of injury.

To reduce this risk, children must always use special child restraint systems when travelling in the vehicle.

We recommend the use of child safety products from the SEAT Genuine Accessories Programme, which includes systems for all ages made by Peke<sup>1)</sup>.

These systems have been especially designed and approved, complying with the ECE-R44. regulation.

Follow the manufacturer's instructions and observe any statutory requirements when installing and using child seats. Always read and note → page 47, Safety notes on using child seats.

<sup>1)</sup> Not for all countries

We recommend you to include the manufacturer's Child Seat instruction manual together with the on-board documentation. ■

#### Safety notes on using child seats

*Proper use of child seats substantially reduces the risk of injury in an accident!*

As the driver, you are responsible for any children you transport in your vehicle.

- Protect your children by properly using the appropriate child seats → page 49.
- Always ensure that the seat belt is properly positioned according to the instructions provided by the manufacturer of the child seat.
- When travelling, do not allow children to distract you from traffic.
- Take breaks regularly during long trips. Take a break at least every two hours. ▶

**WARNING**

- Never install a child seat facing backwards on the front passenger seat unless the front passenger airbag has been disabled. This could lead to a risk of potentially fatal injuries to the child! However, if it is necessary, in exceptional cases, to transport a child in the front passenger seat, the front passenger airbag must always be disabled ⇒ page 45, Deactivating airbags. If the passenger seat has a height adjustment option, move it to the highest position.
- For those vehicles that do not include a key lock switch to disconnect the airbag, the vehicle must be taken to a Technical Service.
- All passengers, especially children, must assume the proper sitting position and be properly belted in while travelling.
- Never hold children or babies on your lap, this can result in potentially fatal injuries to the child!
- Never allow a child to be transported in a vehicle without being properly secured, or to stand up or kneel on a seat while travelling. In an accident, the child could be flung through the vehicle, causing possibly fatal injuries to themselves and to the other passengers.
- If children assume an improper sitting position when the vehicle is moving, they expose themselves to greater risk of injury in the event of a sudden braking manoeuvre or in an accident. This is particularly important if the child is travelling on the front passenger seat and the airbag system is triggered in an accident; as this could cause serious injury or even death.
- A suitable child seat can protect your child!
- Never leave an unsupervised child alone on a child seat or in the vehicle.
- Depending on weather conditions, it may become extremely hot or cold inside the vehicle. This can be fatal.

**WARNING (Continued)**

- Children who are less than 1.5 metres tall must not wear a normal seat belt without a child seat, as this could cause injuries to the abdominal and neck areas during a sudden braking manoeuvre or in an accident.
- Do not allow the seat belt to become twisted or jammed, or to rub on any sharp edges.
- Incorrectly worn seat belts can cause injuries even in a minor collision or in sudden braking manoeuvres.
- The seat belt provides maximum protection only when the seat belt is properly positioned ⇒ page 24, Seat belts.
- Only one child may occupy a child seat ⇒ page 49, Child seats.

## Child seats

### Categorisation of child seats into groups

*Use only child seats that are officially approved and suitable for the child.*

Child seats are subject to the regulation ECE-R 44. ECE-R stands for: Economic Commission for Europe Regulation

The child seats are grouped into 5 categories:

**Group 0:** up to 10 kg

**Group 0+:** up to 13 kg

**Group 1:** from 9 to 18 kg

**Group 2:** from 15 to 25 kg

**Group 3:** from 22 to 36 kg

Child seats that have been tested and approved under the ECE R44 standard bear the test mark on the seat (the letter E in a circle with the test number below it).

### Group 0 and 0+ child seats

*A suitable child seat and a correctly adjusted seat belt can help you to protect your child.*

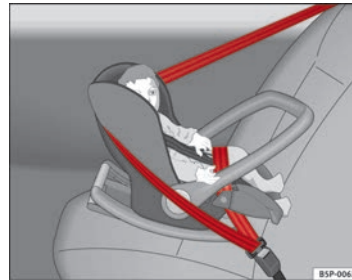

**Fig. 29** A group 0 rear-facing child seat fitted on the rear seat.

**Group 0:** For babies from about 9 months old and 10 kg in weight, the most suitable seats are those appearing in the illustration ⇒ Fig. 29.

**Group 0+:** For babies from about 18 months old and 13 kg in weight the most suitable seats are those appearing in the illustration.

Follow the manufacturer's instructions and observe any statutory requirements when installing and using child seats.

We recommend you to include the manufacturer's Child Seat instruction manual together with the on-board documentation.

#### **WARNING**

**Read and always observe information and warnings concerning the use of child seats ⇒  in Safety notes on using child seats on page 48.**

### Group 1 child seats

*A suitable child seat and a correctly adjusted seat belt can help you to protect your child.*



**Fig. 30** A category 1 forward-facing child seat fitted on the rear seat.

Child seats using the ISOFIX system or seats in which the child faces the rear of the vehicle are most appropriate for babies and small children weighing between 9 and 18 kg.

Follow the manufacturer's instructions and observe any statutory requirements when installing and using child seats.

We recommend you to include the manufacturer's Child Seat instruction manual together with the on-board documentation.

#### **WARNING**

**Read and always observe information and warnings concerning the use of child seats ⇒  in Safety notes on using child seats on page 48.**

### Group 2 and 3 child seats

*A suitable child seat and a correctly adjusted seat belt can help you to protect your child.*



**Fig. 31** Forward-facing child seat installed on rear seat.

Follow the manufacturer's instructions and observe any statutory requirements when installing and using child seats.

We recommend you to include the manufacturer's Child Seat instruction manual together with the on-board documentation.

#### **Group 2 child seats**

Children *under* 7 years of age weighing between 15 and 25 kg are best protected by group 2 child seats together with properly adjusted seat belts.

#### **Group 3 child seats**

Children *over* 7 years of age weighing between 22 and 36 kg but less than 1.5 metres tall are best protected by seat cushions with head restraints together with properly worn seat belts ⇒ **Fig. 31.**

**WARNING**

- The shoulder part of the seat belt must lie approximately on the centre of the shoulder, never across the neck or the arm. The seat belt must lie close to the upper part of the body. The lap belt part must lie across the pelvis, not across the stomach, and always fit closely. Pull the belt tight if necessary to take up any slack ⇒ page 24, Seat belts.
- Read and always observe information and warnings concerning the use of child seats ⇒ ⚠ in Safety notes on using child seats on page 48. ■

## Securing child seats

### Ways to secure a child seat

*A child seat can be secured differently on the rear seat and on the front passenger seat.*

You can secure a child seat to the rear seat or front passenger seat in the following ways:

- Child seats in groups **0 to 3** can be secured with a seat belt.
- Seats for children aged **0, 0+ and 1** with the "ISOFIX" system can be secured without fastening seat belts, using the "ISOFIX" and/or Top Tether securing rings ⇒ page 53.

Mass group	Seating position		
	Front passenger seat	Rear side seat	Rear central seat
Group 0 to 10 kg	U*	U	U
Group 0+ to 13 kg	U*	U	U
Group I 9 to 18 kg	U*	U	U
Group II 15 to 25 kg	U*	U	U
Group III 22 to 36 kg	U*	U	U

U: Suitable for universal restraint systems for use in this mass group.

\*: Move the front passenger seat as far back as possible, as high as possible and always disable the airbag.



#### WARNING

- When travelling, children must be secured in the vehicle with a restraint system suitable for age, weight and size.
- Never install a child seat facing backwards on the front passenger seat unless the front passenger airbag has been disabled. This could cause fatal injuries to the child! However, if, in exceptional cases, it is necessary to transport a child in the front passenger seat, the front passenger airbag ⇒ page 45, Deactivating airbags must always be disabled and the seat adjusted to its highest position, where possible.
- Read and always observe information and warnings concerning the use of child seats ⇒ ⚠ in Safety notes on using child seats on page 48.

### Child seat mounting using the “ISOFIX” and/or Top Tether system

The Child restraint systems may be fitted to the rear seat quickly and safely with the “ISOFIX” and/or Top Tether system (fitted to the rear backrest).

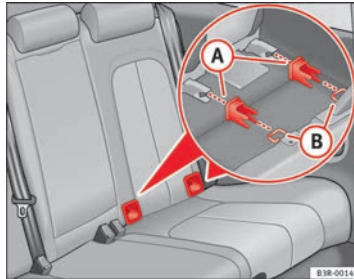

**Fig. 32** Position of the ISOFIX anchors on the side rear seat



**Fig. 33** The ISOFIX child seat anchors slide along the fitted plastic guides until secured in the vehicle's ISOFIX anchorages

Following the instructions given by the child seat manufacturer when installing and removing the seat.

- Fit the plastic guides on the vehicle's ISOFIX anchorages between the backrest and the seat ⇒ Fig. 32.
- Slide the child seat anchorages along the plastic guides until secured in the vehicle's ISOFIX rings (when correctly closed, you will hear a “click”). The seat should also have a visual indicator to confirm it is correctly secured ⇒ Fig. 33.
- Check that the ISOFIX system is correctly secured by pulling on the child seat.

Detailed fitting instructions are supplied with the child safety seat.

Child seats with “ISOFIX” mountings are available from Technical Services and specialist retailers. ▶

Mass group	Size class	Electrical equipment	Mounting direction	Vehicle Isofix positions
				Rear side seats
Baby carrier	F	ISO/L1	Backward-facing	X
	G	ISO/L2	Backward-facing	X
Group 0 to 10 kg	E	ISO/R1	Backward-facing	IU
	E	ISO/R1	Backward-facing	IU
Group 0+ to 13 kg	D	ISO/R2	Backward-facing	IU
	C	ISO/R3	Backward-facing	X
	D	ISO/R2	Backward-facing	IU
Group I 9 to 18 kg	C	ISO/R3	Backward-facing	X
	B	ISO/F2	Forward-facing	IU
	B1	ISO/F2X	Forward-facing	IU
	A	ISO/F3	Forward-facing	IU
Group II 15 to 25 kg	---	---	Forward-facing	---
Group III 22 to 36 kg	---	---	Forward-facing	---

IU: Suitable for ISOFIX universal child restraint systems approved for use in this mass group

X: ISOFIX position not suitable for ISOFIX child restraint systems for this mass group or size class



#### WARNING

The retainers employed for this child safety seat are specially designed for the "ISOFIX" system. Never secure other child seats, seat belts or other items into the retainers. If you do, you increase the risk of sustaining severe or fatal injuries.

### Top Tether retainer straps

*Some child restraint seats have a third Top Tether anchoring point, apart from both ISOFIX anchoring points, which allow better child retention.*

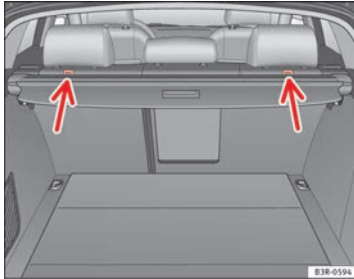

**Fig. 34** Position of the Top Tether rings on the rear tray

The Top Tether system has an upper strap for attachment to the vehicle's upper anchoring point, which is found on the rear luggage compartment cover.

The retainer strap is used to reduce forwards movements of the safety seat in a crash, helping reduce the risk of injuries to the head from hitting the inside of the vehicle.

It is foreseen that an EU Directive will introduce requirements related to the retention of child restraint systems by means of ISOFIX and Top Tether anchorages (probably compulsory for new types from 2010), which will entail improved retention of the child restraint seat and less head movement in case of frontal collisions.

### Use of retainer straps on rear-facing seats

At present there are very few rear-facing child safety seats fitted with a retainer strap. Please carefully read and follow the safety seat manufacturer's instructions for information on how to install the retainer strap properly.

#### **⚠ WARNING**

**An undue installation of the safety seat will increase the risk of injury in the event of a crash.**

- Never tie the retainer strap to a hook in the luggage compartment.
- Never secure or tie luggage or other items to the lower anchorages (ISOFIX) or the upper ones (Top Tether).

### Fitting the Top Tether child restraint to the anchoring point

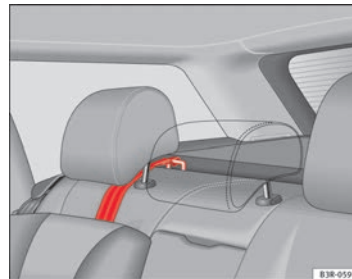

**Fig. 35** Retainer strap: correct adjustment and fitting

**Securing the Top Tether child restraint to the anchoring point situated on the rear shelf**

- Pull out the fastening belt of the child restraint seat according to the manufacturer's instructions.
- Lead the Top Tether fastening belt under the rear seat head restraint ⇒ Fig. 35 (lift the head restraint where necessary).
- Slide the belt so that the Top Tether belt of the child restraint seat is correctly secured to the rear shelf anchorage.
- Firmly tighten the Top Tether belt following the child restraint seat manufacturer's instructions.

**Releasing the retaining strap**

- Release the retainer strap in line with the instructions given by the child safety seat manufacturer.
- Push the lock and release it from the anchoring support.

**WARNING**

Read and bear in mind all the WARNINGS ⇒ page 55.



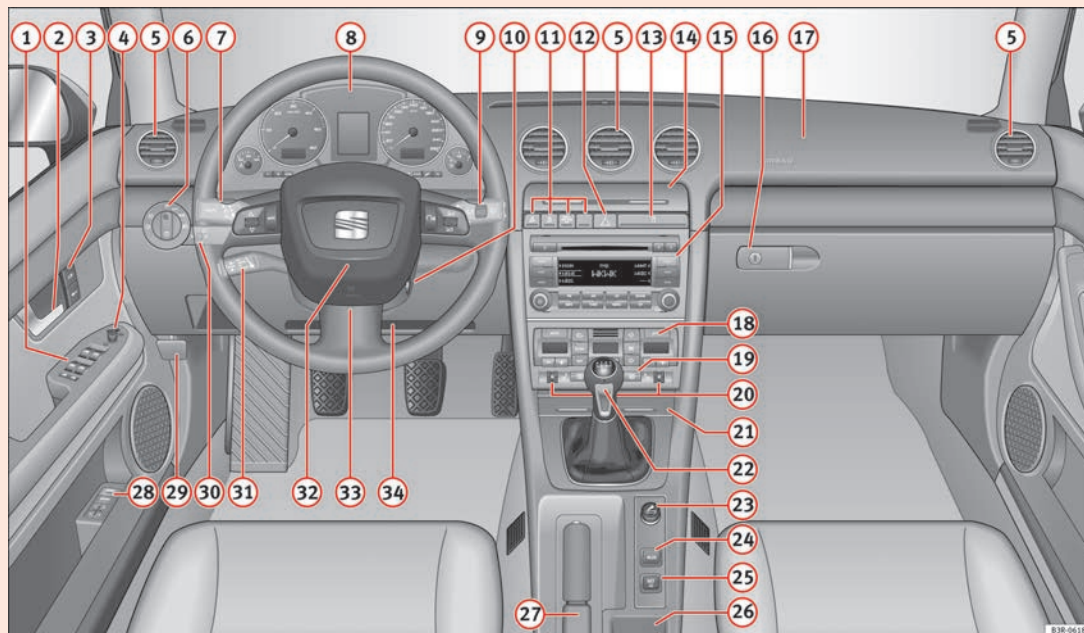

Fig. 36 Some of the equipment listed in this section is only fitted on certain models or are optional extras.

# Operating Instructions

## Cockpit

### Overview

#### Dash panel overview

① Electric windows .....	112	⑬ Drink holder .....	153
② Door handle .....		⑭ Storage compartment .....	
③ Central locking switch .....	103	⑮ Depending on equipment fitted: Sound system or navigation system .....	
④ Electric control for exterior mirrors .....	133	⑯ Lockable glove compartment .....	159
⑤ Air outlets with thumbwheel .....	169	⑰ Front passenger airbag .....	33
⑥ Light switch .....	117	⑱ Air conditioner .....	164
⑦ Lever for turn signals and main beam headlights .....	124	⑲ Switch for heated rear window .....	128
⑧ Instrument panel .....	61	⑳ Thumbwheel for seat heating .....	171
⑨ Levers and switches for:		㉑ Ashtray .....	154
– Windscreen wipers and washer .....	129	㉒ Manual gear lever .....	
– Onboard computer .....	88	㉓ Cigarette lighter / Power socket .....	154
– Menu display .....	91	㉔ Auxiliary socket .....	
⑩ Ignition lock .....	173	㉕ Tyre pressure monitoring .....	69
⑪ Depending on equipment fitted:		㉖ Storage compartment .....	179
– Electronic Stability Control (ESC) .....	71	㉗ Handbrake .....	139
– Start-Stop switch .....	176	㉘ Seat memory* .....	233
– Warning lamp indicating that front passenger airbag has been disabled .....	45	㉙ Bonnet lock release .....	121
– Switch for acoustic parking aid .....	181	㉚ Headlight range control .....	
⑫ Hazard warning lights .....	123	– coming home and leaving home: delayed lights off and anticipated lights on function .....	119
		㉛ Lever for cruise control .....	183 ▶

32	Steering wheel with:	
	– Horn	
	– Driver airbag .....	33
	– Controls for radio and telephone*	
33	Adjustable steering column .....	172
34	On-board documentation compartment / knee airbag* .....	33

**Note**

- Separate Instruction Manual is enclosed if the vehicle is equipped with a factory-fitted radio or navigation system.
- The arrangement of switches and controls on right-hand drive models\* may be slightly different from the layout shown in ⇒ Fig. 36. However, the symbols used to identify the controls are the same. ■

## Instruments

### Instrument panel overview

The instrument panel is the driver's information centre.

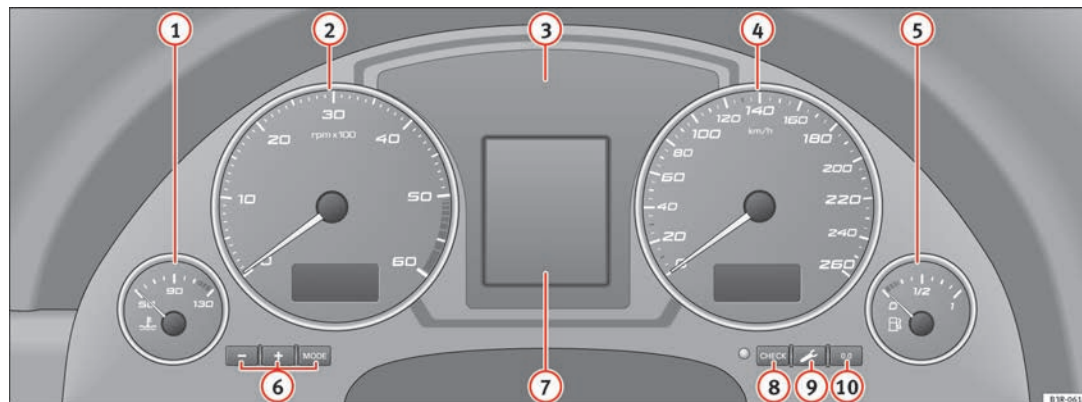

Fig. 37 Overview of instrument panel

① Coolant temperature gauge .....	62	⑥ Adjuster buttons for	
② Rev counter incorporating digital clock and date .....	63, 63	– Digital clock and date .....	63
③ Warning and indicator lamps .....	67	– Instrument lighting .....	64
④ Speedometer (incorporating odometer display) .....	65	⑦ Digital display with	
⑤ Fuel gauge .....	65	– Service interval display .....	77
		– Driver information system .....	74 ▶

- 8 CHECK button ..... 66
- 9 Call-up button for service indicator ..... 77
- 10 Reset button for trip recorder ..... 65 ■

## Coolant temperature gauge



Fig. 38 Engine coolant temperature gauge

The coolant temperature gauge ⇒ Fig. 38 only works when the ignition is switched on. In order to avoid engine damage, please read the following notes for the different temperature ranges.

### Cold temperature (A)

If the needle is still on the left of the dial, this indicates that the engine has not yet reached operating temperature. Avoid high revs and heavy acceleration and do not make the engine work hard.

### Normal temperature (B)

In normal operations, the needle will settle somewhere in the centre of the dial once the engine has reached running temperature. The temperature may also rise when the engine is working hard, especially at high outside

temperatures. This is no cause for concern, provided the warning lamp  does not light up in the instrument panel.

### Warning temperature (C)

If the symbol  flashes in the display, this means that either the coolant temperature is too high or the coolant level is too low ⇒ page 81.

### ! WARNING

- Before opening the bonnet and checking the coolant level, observe the warning information ⇒ page 234.
- Never open the bonnet when steam or coolant is being released from it. This could lead to burns. Wait until you can no longer see or hear escaping steam or coolant.

### ! CAUTION

Accessories in front of the air inlet reduce the cooling effect of the coolant. At high outside temperatures and high engine loads, there is a risk of the engine overheating. ■

## Rev counter

The rev counter indicates the number of engine revolutions per minute.



Fig. 39 Detailed view of the instrument panel: Rev counter

You should select a lower gear if the engine speed drops below 1500 rpm. The start of the red zone on the dial indicates the maximum engine speed which may be used when the engine is warm and after it has been run in properly. Before reaching this zone, a higher gear must be selected or your foot must be removed from the accelerator.

### ! CAUTION

To prevent possible engine malfunctions, the rev counter needle should not reach the red zone. The start of the red zone on the dial is different for some engine versions.



### For the sake of the environment

Changing up into higher gears sooner following the recommended gear indications ⇒ Fig. 50 will help you to reduce fuel consumption, emissions and also engine noise. ■

## Digital clock and date

Your vehicle is equipped with a quartz clock.



Fig. 40 Detailed view of the instrument panel: Digital clock

The **time** and **date** are set using the  $\square$  and  $\square$  buttons.

### Setting the hour









- Press the **MODE** button. The hour display will start to flash.
- Use the  $\square$  and  $\square$  buttons to set the hour.

### Setting the minutes



- Keep pressing the **MODE** button until the minutes display flashes.
- Use the  $\square$  and  $\square$  buttons to set the minutes.

### Setting the date



- Keep pressing the **MODE** button until the date display (day) flashes. ▶

- Use the  and  buttons to set the day.
- Keep pressing the  button until the month display flashes.
- Use the  and  buttons to set the month.
- Keep pressing the  button until the year display flashes.
- Use the  and  buttons to set the year.

#### Deactivating the date display

- Keep pressing the  button until the complete date display flashes.
- Use the  button to disable the date display.

#### Activating the date display

- Keep pressing the  button until the complete date display flashes.
- Use the  button to enable the date display.

When the display stops flashing, this means the setting you are performing is completed and the time and date have been successfully stored.

When the ignition is switched off, the odometer and the digital clock with date display can be switched on for a few seconds by pressing the CHECK button ⇒ Fig. 37 .

### Instrument lighting

*The brightness of the instrument lighting can be adjusted as required.*



**Fig. 41 Instrument panel lighting**

- Press the "+" button to increase the brightness of the instrument lighting.
- Press the "-" button to reduce the brightness of the instrument lighting.

■ The instrument lighting (dials and needles), the centre console illumination and the illumination of the displays are regulated by a photodiode incorporated in the instrument panel, depending on the outside light. ■

## Speedometer with odometer

The speedometer indicates the speed of the vehicle and the distance travelled.



Fig. 42 Detailed view of the instrument panel: Odometer

The distance is normally stated in kilometres (km). On some models, however, the odometer will show "miles".

### Lower odometer

The lower odometer records the vehicle's total mileage.

### Upper odometer (trip recorder)

The upper odometer shows the distance that has been travelled since the trip recorder was last reset. It is used to measure short trips. The last digit of the trip recorder indicates distances of 100 metres or tenths of a mile. The upper odometer can be reset to zero by pressing the reset button ⇒ Fig. 42.

### Fault display

If there is a fault in the instrument panel, the letters **DEF** will appear permanently in the trip recorder display. Please have the fault repaired as soon as possible.

### Electronic immobiliser

The vehicle key data is consulted when the ignition is switched on.

If an uncodded key is used, the message **SAFE** will appear in the trip recorder display. The vehicle can no longer be started if that happens. ■

### Fuel reserve

The display only works when the ignition is switched on.

When the needle reaches the reserve zone, the symbol  lights up in the instrument panel display ⇒ page 83. At this point there are still about 8 to 10 litres of fuel left in the tank. This is your reminder **to fill up soon**.

You can consult the tank capacity of your vehicle in the ⇒ page 312, Dimensions and capacities section.



### CAUTION

Never run the tank completely dry. If there is an irregular fuel supply, misfiring can occur. This means that fuel could reach the exhaust system without burning. This may lead to the catalytic converter reheating and being damaged. ■

## CHECK button



Fig. 43 Detailed view of the instrument panel: CHECK button

The **CHECK** button has the following functions:

### Activating the digital clock and the odometer

When the ignition is switched off, the odometer and the digital clock with date display can be enabled for a few seconds by pressing the **CHECK** button → Fig. 43.

### Starting check procedure (auto-check control)

The auto-check control → page 78 checks important components and vehicle systems. These background checks are run constantly, as long as the ignition is switched on.

You can start the “check procedure” manually by pressing the **CHECK** button with the ignition switched on. This function check can be started with the engine either stationary or running, but not at road speeds above 5 km/h.

### Calling up driver messages

If a Priority 1 symbol flashes in the display → page 78, or if the bulb monitor detects a failure of one of the lights → page 85, the relevant driver in-

formation can be called up again by briefly pressing the **CHECK** button. For example:

#### Switch off engine, check oil level

The message will disappear from the display after about 5 seconds.

#### Setting the speed warning

You can press the **CHECK** button to set speed limit warning 1 → page 86, Setting speed limit warning 1 **while the vehicle is moving**. Speed limit warning 2\* → page 87, Setting speed limit warning 2 can only be set **when the ignition is switched off**. ■

## Warning and indicator lamps

### General description

The warning and indicator lamps indicate a number of different functions and possible faults.



Fig. 44 Instrument panel with warning and indicator lamps

	Exhaust emission control system	⇒ page 68
	Airbag system	⇒ page 68
	Tyre pressure too low	⇒ page 69
	Cruise speed (Cruise control)	⇒ page 69

	Trailer turn signals	⇒ page 69
	Anti-lock brake system (ABS)	⇒ page 70
	Seat belt warning	⇒ page 70
	<b>If it stays lit:</b> ASR switched off	⇒ page 71 ⇒ page 71 ⇒ page 172
	Left turn signals	⇒ page 71
	<b>If flashing:</b> the Electronic Stability Control (ESC) is working or the ASR is working <b>If the following remain lit:</b> ESC or ASR faulty	⇒ page 71 ⇒ page 71 ⇒ page 172
	Alternator	⇒ page 72
	Main beam headlights	⇒ page 72
	Handbrake on	⇒ page 72 ⇒ page 79
	Engine management (alternative to )	⇒ page 72
	Glow plug system (alternative to <b>EPC</b> )	⇒ page 72
	Fault in brake system	⇒ page 73
	Right turn signals	⇒ page 71

**Note**

A number of functions are monitored by the auto-check control ⇒ page 78. If a malfunction should occur, this will be shown by the display in the instrument panel either with a red symbol (priority 1 - danger) or a yellow symbol (priority 2 - warning). ■

**WARNING**

**If a malfunction should occur, have the system checked immediately by a specialised workshop. Otherwise there is a risk that the airbag system and/or belt tensioners may not be triggered in an accident.** ■

### Exhaust emission control system

---

If the warning lamp **lights up continuously** you should take your vehicle to a specialised workshop as soon as possible in order to have the fault repaired.

If the warning lamp **flashes** drive on at reduced speed and seek professional help in order to avoid damage to the catalytic converter.

For further information on the catalytic converter, see ⇒ page 202. ■

### Airbag system

---

*This warning lamp monitors the airbag and belt tension device system.*

The warning lamp  should light up for a few seconds when the ignition is switched on.

If the warning lamp does not go out, or if it lights up, flashes or flickers when the vehicle is moving, this indicates a malfunction in the system.

### Tyre pressure warning lamp\* (L)

The tyre pressure should be corrected as soon as possible if it is too low.

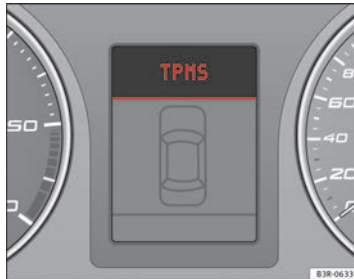

Fig. 45 Display: system fault

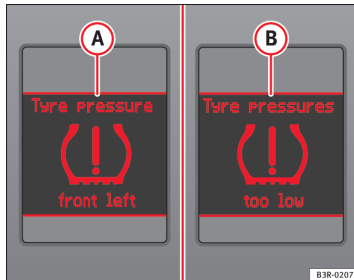

Fig. 46 Display: warning message

The yellow warning (L) lamp remains on if the system is faulty or if the pressure is too low in at least one tyre. In the event of a system fault, the letters TPMS are displayed in the centre of the instrument panel ⇒ Fig. 45. If the tyre pressure drops rapidly, message (A) ⇒ Fig. 46 will be shown on the central display of the instrument panel. If the pressure loss is more gradual, message (B) ⇒ Fig. 46 will be shown on the central display of the instrument panel. This message does not show the tyre affected. Should any of these warnings be displayed:

- Stop the vehicle.
- Check the tyres. Although the warning corresponds to just one tyre, you should also check the others.
- Correct the tyre pressure ⇒ page 250.

For more detailed information on the tyre pressure monitoring system, please refer to ⇒ page 249.

### Cruise speed (Cruise control)\* Ⓜ

The indicator lamp Ⓜ on the instrument panel lights up when the cruise control system is operating.

### Trailer turn signals\* Ⓜ

This turn signal lamp flashes when the turn signals are operating while towing a caravan or trailer.

The turn signal lamp Ⓜ flashes when the turn signals are operated if a trailer is correctly coupled to the vehicle.

Where a turn signal bulb does not work, either on the trailer or on the towing vehicle, the turn signal bulb will not flash.

### Anti-lock brake system (ABS)

*The warning lamp monitors the ABS and the integrated electronic differential lock (EDL).*

The warning lamp  lights up for a few seconds when the ignition is switched on and while the engine is being started. The lamp goes out again after the system has run through an automatic test sequence.



#### There is a fault in the ABS if:

- The warning lamp does not light up when the ignition is switched on
- The warning lamp does not go out again after a few seconds
- The warning lamp lights up when the vehicle is moving

The vehicle can still brake in the normal way (except that the ABS control function is out of action). Please take the vehicle to a specialised workshop as soon as possible. For further information on the ABS, see ⇒ page 196.

If a malfunction should occur in the ABS, the ESC warning lamp will also light up.

#### Entire brake system fault

If the ABS warning lamp  lights up together with the brake warning lamp  ⇒ page 73 (with the handbrake released), this indicates not only a fault in the ABS function, but probably also a malfunction in the main brake system ⇒ .



The symbol  will light up on the instrument panel if there is a **fault in the brake system**. Please refer to ⇒ page 80.

### Electronic differential lock (EDL) fault

The EDL works in conjunction with the ABS. The ABS indicator lamp will light up  to indicate an EDL fault. Please take the vehicle to a specialised workshop as soon as possible. For further information on the EDL, see ⇒ page 197.



#### WARNING

- Before opening the bonnet and checking the brake fluid level, observe the warning information in ⇒ page 234, Work in the engine compartment.
- If the brake warning lamp  should light up together with the ABS warning lamp , stop the vehicle immediately and check the brake fluid level in the reservoir. If the fluid level has dropped below the "MIN" mark you must not drive on, as there is a risk of accident. Obtain technical assistance.
- If the brake fluid level is correct, the fault in the brake system may have been caused by a fault in the ABS control function. As a result, the rear wheels can lock relatively easily when braking. Under certain circumstances, the rear of the vehicle could suddenly sway from side to side, with the subsequent danger of skidding. Drive carefully to the nearest specialised workshop and have the fault repaired.



### Seat belt warning lamp\*

*The warning lamp acts as a reminder to the driver to fasten the seat belt.*

After switching on the ignition, the warning lamp  will remain lit until the driver and front passenger (if applicable) have fastened their seat belts. When the vehicle has reached a certain speed, you will also hear a warning signal and the warning light will flash.

For further information on the seat belts, see ⇒ page 24.



## Turn signals and hazard warning lights

Depending on which turn signal is operated, either the left  or right  turn signal lamp flashes. Both turn signal lamps will flash when the hazard warning lights are switched on.

If a turn signal fails, the indicator lamp will start flashing twice as fast as normal.

This does not apply when towing a trailer. Where a turn signal bulb does not work, either on the trailer or on the towing vehicle, the turn signal bulb will not flash. For further information on the turn signals, see  $\Rightarrow$  page 124. ■

## Electronic Stability Control (ESC)\* /

*There are two control lamps for the electronic stability control. The  lamp provides information concerning the function and the  provides information on the disconnection status*

Both lamps come on together when the ignition is switched on and should go out after approx. 2 seconds, which is how long the function check lasts.

This programme includes the ABS, EDL and ASR. This also includes the brake assistance system (BAS), automatic cleaning of the brake discs and the trailer stability programme (TSP).

**The warning lamp  has the following functions:**

- It flashes whilst driving when the ASR/ESC is activated.
- It will light up continuously if there is a fault in the ESC.
- As the ESC operates in conjunction with the ABS, it will also light up if a fault should occur in the ABS.



If the ESC warning lamp  lights up and stays on after the engine is started, this may mean that the control system has temporarily switched off the ESC. In this case the ESC can be reactivated by switching the ignition off and then on again. If the warning lamp goes out, this means the system is fully functional.

**The  lamp provides information about the disconnection status of the system:**

- It stays lit when the ASR is disconnected when pressing the  switch. ■

## Traction control system (ASR)\* /

*The traction control system prevents the driven wheels from spinning when the vehicle is accelerating*

There are two warning lamps for the traction control system:  and . Both lamps come on together when the ignition is switched on and should go out after approx. 2 seconds, which is how long the function check lasts.

**The  lamp has the following function:**

- It flashes when the ASR is working if the vehicle is moving.

If the system is deactivated or if it has any fault, the warning lamp will remain lit. The warning lamp will also light up if a fault should occur in the ABS because the ASR operates in conjunction with the ABS. For further information, see  $\Rightarrow$  page 195

**The  lamp provides information about the disconnection status of the system:**

- It stays lit when the ASR is disconnected when pressing the ASR OFF switch.

By pressing it again, the ASR function is reactivated and the warning lamp switched off. ■

### Alternator

*The warning lamp signals a fault in the alternator or in the vehicle's electrical system.*

The warning lamp  lights up when the ignition is switched on. It should switch off after the engine has started.

If the warning lamp  lights up when you are driving, you can normally continue as far as the nearest specialised workshop. However, given that the battery will be running down, any electrical consumption not absolutely vital should be switched off.

#### CAUTION

If the coolant warning lamp  in the instrument panel lights up as well as the alternator warning lamp while driving  $\Rightarrow$  page 81, stop the vehicle immediately and switch off the engine. In this case the coolant pump is no longer working, and there is a risk of engine damage.

### Main beam headlights

The indicator lamp  lights up when the main beams are on or when the headlight flasher is operated.

For further information on the main beam headlights, see  $\Rightarrow$  page 124.

### Handbrake

*This lamp lights up when the handbrake is applied.*

If you drive faster than 5 km/h with the handbrake on, the following message will appear on the instrument panel display<sup>1)</sup>: **HANDBRAKE ON**. You will also hear an acoustic warning signal  $\Rightarrow$  page 79.

### Engine management EPC

*This warning lamp monitors the engine management system for petrol engines.*

The warning lamp **EPC** (Electronic Power Control) lights up while the function is being checked.



#### Note

If the warning lamp lights up while the vehicle is moving, this indicates a fault in the engine management system. The vehicle must be taken immediately to a specialised workshop to have the engine serviced.

### Glow plug system

*The control lamp lights up while the glow plugs are preheating the diesel engine.*

The indicator lamp  lights up while the glow plugs are preheating. When the indicator lamp goes out the engine should be started straight away.

<sup>1)</sup> Depending on the version of the model.

When the engine is warm, or at outside temperatures above +8°C, the warning lamp will only light up very briefly.



#### Note

- If the glow plug indicator lamp should start flashing while the vehicle is moving, this indicates a fault in the engine management system. The engine should be serviced without delay.
- If the indicator lamp fails to light up when the ignition is switched on, this can mean that the glow plug system is defective. The engine should be serviced.

## Brake system ⓘ

*The warning lamp flashes when the handbrake is applied, or if the brake fluid level is too low or if there is a fault in the ABS system.*

If the warning lamp ⓘ flashes (and the handbrake is not applied), stop the vehicle and check the brake fluid level ⇒ ⚠ ⇒ page 244.

If a failure should occur in the ABS, the ABS warning lamp ⓘ will light up together with the brake warning lamp ⓘ ⇒ ⚠.

### Handbrake on

The warning lamp ⓘ also lights up when the handbrake is applied. In addition to this, the handbrake warning ⇒ page 79 switches on after driving for 3 seconds at a speed above 5 km/h.



### WARNING

- Before opening the bonnet and checking the brake fluid level, observe the warning information in ⇒ page 234, Work in the engine compartment.
- If the brake warning lamp does not go out, or if it lights up when driving, the brake fluid level in the reservoir is too low and this may cause an increased accident risk. Stop the vehicle and do not drive on. Obtain technical assistance.
- If the brake warning lamp lights up together with the ABS warning lamp, this can mean that there is a fault in the ABS control function. As a result, the rear wheels can lock relatively easily when braking. Under certain circumstances, the rear of the vehicle could suddenly sway from side to side, with the subsequent danger of skidding. Drive carefully to the nearest specialised workshop and have the fault repaired.

## Driver information system

### General notes

*The driver information system in the instrument panel shows the status of various on-board systems at a glance.*

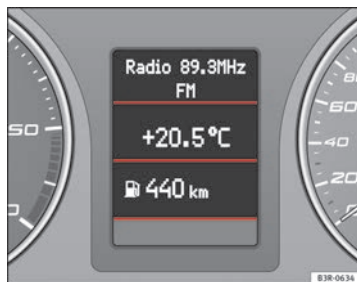

**Fig. 47** Cockpit: Digital instrument panel display

The display for the driver information system is in the centre of the instrument panel.

The system runs a check on certain components and functions when the ignition is switched on and while the vehicle is moving. The DIS system gives an audible warning if a fault should occur or if servicing is required, and a red or yellow warning symbol (in some cases with a corresponding driver message) appears in the instrument panel display.

The driver is informed on the audio system.

The driver information system includes the following functions:

CD player, radio and telephone display*	⇒ page 75
Outside temperature display	⇒ page 75
Gear indicator*	⇒ page 76
Selector lever positions for the 7-speed automatic gearbox*	⇒ page 192
Selector lever positions with multitronic®*	⇒ page 189
Distance to empty	⇒ page 76
Door and rear lid warning	⇒ page 77
Service indicator	⇒ page 77
auto-check control	⇒ page 78
Driving tips	⇒ page 79
Handbrake warning	⇒ page 79
Bulb monitor*	⇒ page 85
Onboard computer*	⇒ page 88
Tyre pressure monitoring*	⇒ page 92
Navigation information*	Separate Instruction Manual



### Note

- If a fault should occur, the display will show a red or yellow warning symbol. A red warning symbol indicates a **serious malfunction** ⇒ page 80. A yellow warning symbol indicates a less serious **malfunction** ⇒ page 82. ■

### CD, radio and telephone\* display

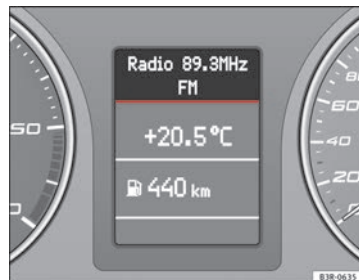

Fig. 48 Display: additional radio information

If the radio is switched on and no Priority 2 faults are indicated by the auto-check control, depending on the type of radio fitted, the display will show the name or frequency of the selected radio station and complementary information, once the "OK" symbol has gone out.

When in CD mode\*, the display will show the current track.

If you have a compatible telephone\*, the phone book or telephone dialled can also be seen on this display.

These displays appear *in addition* to the display on the radio itself.

### Outside temperature display

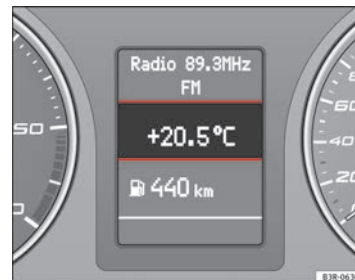

Fig. 49 Display: Outside temperature display

The outside temperature is shown in the display when the ignition is switched on ⇒ Fig. 49. In vehicles with an automatic gearbox, the display does not appear until the driver has engaged a gear.

At temperatures below +5°C a snowflake symbol appears next to the temperature display. This is to warn the driver to take extra care when there is a risk of **ice** on the road. When the vehicle is stationary or travelling at very low speeds, the temperature displayed may be slightly higher than the actual ambient temperature as a result of heat coming from the engine.

If the vehicle has an air conditioner and the digital display is changed over to °F (degrees Fahrenheit), the outside temperature indicator automatically changes over to °F ⇒ page 168.



#### WARNING

**Do not rely on the outside temperature display as an ice warning. Please bear in mind that there may be ice on the roads even at outside temperatures of +5°C beware of ice patches.**

**Note**

When the display shows route guidance instructions from the navigation system, the outside temperature appears in the second line of the radio display.

### Gear display\*

*This display helps to save fuel.*

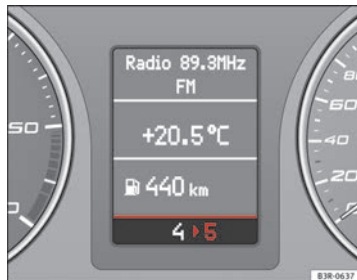

Fig. 50 Gear display

Use the gear display to save fuel. The indication => Fig. 50 on the instrument panel display recommends that you select the gear indicated by the arrow. It may also skip a gear, and recommend changing up from 4th gear to 6th gear, for example.

**Note**

- The display may not recommend any gear-change while you are accelerating.
- The gear change indication should not be taken into account the acceleration is required (for example when overtaking).
- If desired, you can have the gear-change display deactivated by a Technical Service.

### Distance to empty

*The distance to empty display can help you to plan your trip.*

The estimated distance to empty is displayed in km. It shows how far the vehicle can be driven with the amount of fuel left in the tank, assuming the same style of driving. The distance to empty is displayed in increments of 10 km.

The distance to empty is calculated on the basis of the fuel consumption over the last 30 kilometres. The distance to empty will increase if you drive in a more economical manner.

## Door and rear lid warning



Fig. 51 Display: Door and rear lid warning

The door and rear lid warning symbol lights up if *one or more* of the doors, or the bonnet or rear lid are not properly closed when the ignition is on. The symbol also indicates *which* of these is not properly closed. The display in the illustration ⇒ Fig. 51 shows that the driver door is open.

The corresponding part of the pictogram will flash if either the bonnet or rear lid are open. The warning symbol goes out when the bonnet, rear lid and all the doors are closed.

In vehicles with a driver information system and an onboard computer\* the door catches/rear lid warning symbol can be switched off by briefly pressing one of the control switches for the onboard computer ⇒ page 89. However, the warning symbol will appear again if any of the doors or the bonnet or rear lid is opened or closed.

## Service indicator

*This display reminds the driver when the next routine service is due.*

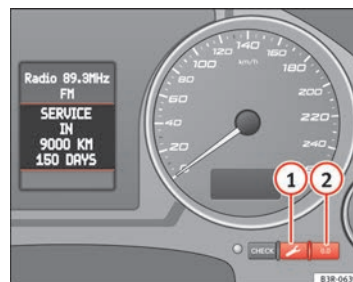

Fig. 52 Detailed view of the instrument panel: Service indicator

### Displaying distance to next service

When you press the service button **1** briefly with the ignition switched on, the display will show how far the vehicle can be driven before the next service is due. This check can be carried out with the engine stopped or running up to 5 km/h. Before the first 500 km and after the ignition cycle, the kilometres and days before the service inspection are not displayed.

If the service button **1** is pressed before the first 500 km the following indication appears on screen:

**Service in ---- km --- days**

This is only valid for vehicles with "LongLife Service Intervals"\*. ▶

### Service reminder

The instrument panel controls the distance travelled every day. It calculates the average of these distances travelled and activates the service reminder sufficiently in advance.

The display reverts back to the standard display after about 5 seconds. The remaining distance to the next service is updated every time the ignition is switched on, until the service becomes due.

### Service due

When a service is due, **SERVICE!** will appear in the display immediately after you switch on the ignition. The display reverts back to the standard display after about 5 seconds.

### Resetting the display

The display is reset by the specialised workshop after the service has been carried out. The service interval will be set to a LongLife Service (flexible service interval) or Inspection Service (fixed service interval), depending on which engine oil is used. It is only possible to reset the display via the instrument panel when an oil change is performed; in this case the display can only be reset to a fixed service interval of 15 000 km. Proceed as follows:

- Switch the ignition off.
- Press the service button ⇒ Fig. 52 ① and hold while switching on the ignition. The display will show one of these messages: **Service in ----- km or Service!**
- Now press and hold the reset button ② until the display shows **Service in ----- km --- days or Service!**

The display switches out of the reset mode if you do not press the reset button within 5 seconds.



### CAUTION

The system cannot calculate the figures for the service interval display if the battery is disconnected from the vehicle, so no service reminder can be displayed during this time. Please remember that it is essential to service the vehicle within the established time limits to prevent its deterioration and to extend its useful life (particularly that of the engine). The period between two services must never be longer than the time specified in the Maintenance Programme, even if you only cover a low mileage during this time.



### Note

- Do not reset the service indicator between services, otherwise the display will be incorrect.
- The information in the service indicator remains intact if the battery is disconnected.
- The distance to the next service cannot be called up if the system has detected a Priority 1 fault (red symbol).

## Auto-check system

### Introduction

The auto-check system checks important components and vehicle systems. These background checks are run constantly, as long as the ignition is switched on.

A message is displayed on the instrument panel if a fault should occur or if any maintenance or repairs are urgently required. This is accompanied by an audible warning signal. Depending on the priority of the fault, a red or yellow warning symbol lights up on the display.

The red symbol indicates **danger**, whereas the yellow one represents a **warning**. Additional messages for the driver may be shown with the red or yellow symbols.

## Driver messages

*Additional messages for the driver are displayed together with the warning symbols on the instrument panel.*



Fig. 53 Instrument panel: CHECK button

### Driver messages and red symbols

If a red warning symbol appears on the display, you can press the **CHECK** button ⇒ Fig. 53 to call up an additional driver message.

For example: in the event of an oil pressure malfunction, the oil pressure symbol  will appear in the display. If you now press the **CHECK** button, the following message will appear in the display:

**Switch off engine, check oil level**

The message will disappear from the display after about 5 seconds. If required, the message can be called up again by briefly pressing the **CHECK** button.

### Driver messages and yellow symbols

If a yellow warning symbol appears in the display, it will automatically be accompanied by the corresponding driver message.

For example, the symbol  is displayed to indicate that the windshield washer fluid level is low. In addition, the following message will appear:

#### Top up washer fluid

The message will disappear after a few seconds. If required, the message can be called up again by briefly pressing the **CHECK** button.



#### Note

- The messages **handbrake on** and **when stationary apply footbrake to select gear** cannot be called up a second time. They will remain in the display until the handbrake is released or until a gear is selected.

## Handbrake warning

- Release the handbrake.

If you drive by mistake with the handbrake still applied, you will hear a warning buzzer and the display will show the message:

#### Handbrake on

The handbrake warning switches on after driving for 3 seconds at speeds above 5 km/h.

## Red symbols

*A red symbol warns of a danger.*



Fig. 54 Display: Coolant level warning

- Stop the vehicle.
- Switch the engine off.
- Check the fault. Obtain professional assistance if necessary.

	Brake fluid required or brake system fault	⇒ page 80
	Coolant level too low / coolant temperature too high	⇒ page 81
	Engine oil pressure too low	⇒ page 81

The red symbols are used to indicate a Priority 1 fault (serious malfunction).

A red symbol is accompanied by *three* warning chimes. The symbols will keep flashing until the faults are corrected. If *several* Priority 1 faults are de-

tected at the same time, the symbols are displayed one after the other for about 2 seconds. ■

## Fault in the brake system

*A fault in the brake system should be repaired as soon as possible.*

If the symbol flashes in the display, there is a fault in the brake system. One of the following messages will appear in the display together with the symbol:

**Stop vehicle, check brake fluid and hydraulic fluid levels**

**Warning! Fault in brake system (ABS) Take vehicle to workshop**

- Stop the vehicle.
- Check the brake fluid level ⇒ page 244.

If the ABS fails, the ABS warning lamp will light up together with the brake system fault symbol ⇒

**WARNING**

- Before opening the bonnet and checking the brake fluid level, observe the warning information in ⇒ page 234, Work in the engine compartment.
- If the brake fluid level in the reservoir is too low, this could result in an accident. Do not drive on! Obtain technical assistance.
- If the brake warning lamp lights up together with the ABS warning lamp, this can mean that there is a fault in the ABS control function. As a result, the rear wheels can lock relatively easily when braking. Under certain circumstances, the rear of the vehicle could suddenly sway from side to side, with the subsequent danger of skidding. Drive carefully to the nearest specialised workshop and have the fault repaired. ■

**Fault in the cooling system** 

*Faults in the cooling system must be repaired immediately.*

If the symbol flashes in the display, this means that either the coolant *temperature* is too high or the coolant *level* is too low. The following message will appear in the display together with the symbol:

**Switch off engine and check coolant level**

- Stop the vehicle.
- Switch the engine off.
- Check the coolant level ⇒ page 239.
- Add more coolant if necessary ⇒ page 240.
- Wait for the symbol to go out before driving on.

- Obtain professional assistance if necessary.

If the coolant level is correct, the overheating may be caused by a malfunction of the radiator fan.

If the alternator warning lamp lights up as well ⇒ page 72, it is possible that the drive belt has broken.

**CAUTION**

Do not drive on if the symbol has come on to indicate a fault in the cooling system, otherwise there is a risk of engine damage. ■

**Engine oil pressure too low** 

*If the engine oil pressure is too low the fault must be repaired immediately.*

If the symbol flashes in the display, the oil pressure is too low. The following message will appear in the display together with the symbol:

**Switch off engine, check oil level**

- Stop the vehicle.
- Switch the engine off.
- Check the engine oil level ⇒ page 237.
- Obtain professional assistance if necessary.

**Engine oil level too low**

If the engine oil level is too low, add more oil ⇒ page 238. ►

### Engine oil level correct

If the  symbol flashes and the engine oil level is correct, obtain professional assistance. Do not drive on! Do not continue to run the engine, **even at idle speed.**



#### Note

The oil pressure warning lamp  is not an indicator for the oil level. The oil level should therefore be checked regularly, preferably every time you fill the tank. ■

### Yellow symbols

A yellow symbol indicates a warning.

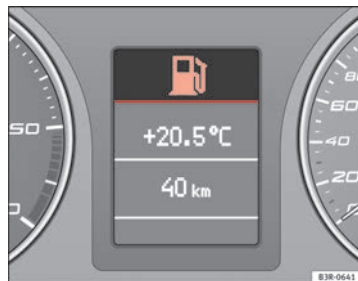



















Fig. 55 Display: Fuel level low

	Brake light failure warning light	⇒ page 83
	Fuel level low	⇒ page 83

	Engine speed governing	⇒ page 83
	Check engine oil level	⇒ page 83
	Engine oil sensor faulty*	⇒ page 83
	Diesel particulate filter* obstructed	⇒ page 83
	Photosensor/rain sensor faulty	⇒ page 84
	Brake pad worn	⇒ page 84
	Speed warning 1	⇒ page 84
	Dynamic headlight range control* faulty	⇒ page 84
	Adaptive headlights* faulty	⇒ page 84
	Washer fluid level low*	⇒ page 84
	Speed warning 2*	⇒ page 84
	Battery voltage too high or too low*	⇒ page 84
	Bulb monitor*	⇒ page 85
	Tyre pressure monitoring system* Loss of pressure	⇒ page 92
<b>TPMS</b>	Tyre pressure monitoring system* System not available	⇒ page 69
	Start-Stop system fault*	⇒ page 178 ▶

Yellow symbols are used to indicate a Priority 2 fault (warning).

Yellow symbols are accompanied by *one* warning buzzer. The function indicated should be checked as soon as possible. If several Priority 2 faults are detected at the same time, the symbols are displayed one after the other for about 2 seconds at a time.

### Brake light failure

This warning light will appear on the upper part of the display if any of the brake lights has failed. A text message in the central part of the display indicates which brake light has failed (left or right).

### Fuel level low

When this symbol  comes on for the first time, there are about 8 to 10 litres of fuel left in the tank. You should fill up as soon as possible ⇒ page 230.

### Engine speed governing

#### Max. engine speed XXXX rpm

There is a fault in the engine management. In addition, the warning lamp **EPC** on the instrument panel will light up. The engine speed will be governed to the speed displayed in the driver information system. Please ensure that the engine speed does not exceed the speed shown (for example, when changing down a gear).

Take the vehicle to a specialised workshop immediately to have the fault repaired.

### Checking the engine oil level





If the  symbol lights up, please check the engine oil level as soon as possible ⇒ page 237. Top up the oil at the next opportunity ⇒ page 238.

### Engine oil sensor defective\*

If the  symbol lights up, take the vehicle to a specialised workshop and have the oil level sensor checked. Until then it is advisable to check the oil level every time you fill up with fuel ⇒ page 237.

### Diesel particulate filter obstructed

If the symbol  lights up, you can contribute towards automatic filter cleaning by driving in the right manner. To do this, drive about 15 minutes in 4th or 5th gear (automatic gearbox: S gear range) at a speed of 60 km/h, with the engine running at approximately 2000 rpm. The increase in temperature will burn off any soot in the filter. When cleaning is successful, the symbol switches off.

If the symbol  does not turn off, or the three lamps turn on (particulate filter , emission control system fault  and heaters ), take the vehicle to a specialised workshop to repair the fault.

For further information on the diesel particulate filter, see ⇒ page 203.

#### **WARNING**

**It is essential that you adjust your speed to suit the weather, road, terrain and traffic conditions. The recommended driving speed must never lead to the driver disregarding the traffic regulations.**

### Photosensor/rain sensor faulty

#### Automatic headlights / automatic wipers faulty

If the  symbol lights up, this means that the photosensor/rain sensor is not working. For safety reasons, the dipped beam headlights will then be switched on permanently when the light switch is set to the **AUTO** position. However, you can still switch the lights on and off in the normal way with the light switch. If the rain sensor is faulty, the functions operated via the windscreen wiper lever will still be available. You should have the photosensor/rain sensor checked by a specialised workshop as soon as possible.

### Worn brake pads

If the  symbol lights up, have the front brake pads (and, for safety reasons, the rear pads as well) inspected by a specialised workshop.

### Speed warning 1

If the  symbol lights up, this means you are exceeding the speed that has been pre-set with the speed warning function. You should reduce your speed accordingly ⇒ page 85.

### Headlight range control faulty

This symbol  indicates a malfunction in the dynamic headlight range control. Take the vehicle to a specialised workshop to have the dynamic headlight range control function repaired.

### Adaptive headlights\* faulty

#### Adaptive headlights faulty

This symbol  indicates that the adaptive headlight system is faulty. Take the vehicle to a specialised workshop to have the headlights or the adaptive headlight control unit repaired.

### Washer fluid level low

If the  symbol lights up, top up the fluid for the windscreen washer and headlight washer system\* ⇒ page 241.

### Speed warning 2

If the  symbol lights up, this means you are exceeding the speed that has been pre-set. You should reduce your speed accordingly ⇒ page 85.

### Battery voltage too high or too low

If the  symbol lights up, take the vehicle to a specialised workshop and have the following items checked:

- Poly V-belt
- Battery condition

It is also advisable to check whether the alternator warning lamp has come on ⇒ page 72.

## Bulb monitor

*The bulb monitor checks whether the lights on the vehicle are working.*

If a defective bulb is detected, or if one of the lights has failed for any reason, the bulb monitor symbol  will appear in the display together with an additional message (which goes out after 5 seconds). For instance, if the rear left turn signal is not working, the display in the instrument panel will show the following message:

### Left rear turn signal

The message disappears after 5 seconds. Press the CHECK button briefly if you wish to call up the message again.

If the display indicates that one of the lights is not working, this can have a number of causes:

- Bulb failure ⇒ page 272.
- A blown fuse ⇒ page 270, Changing fuses.
- Faulty electrical wiring.

It is not necessary to have lamps replaced in a specialised workshop, however the use of Xenon lamps is recommended.

### LED lamps

If any of the LED (Light Emitting Diode) functions fail, the complete lamp should be replaced.

The failure of the lamp is only shown when the LED function goes out completely. Sometimes, a LED will stop working, without displaying the warning as the function continues to operate.

## WARNING

- Bulbs are highly sensitive to pressure. The glass can break when you touch the bulb, causing injury.
- The high voltage element of gas discharge bulbs\* (xenon light) must be handled correctly. Otherwise, there is a risk of death.

## Speed warning\*

### Introduction

*The speed warning function can help prevent you exceeding a particular pre-set maximum speed.*

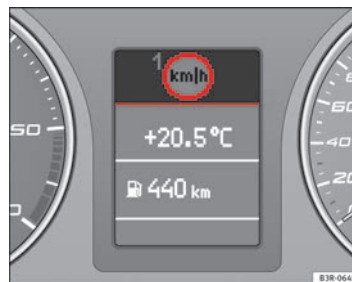



Fig. 56 Display: Speed warning function

The speed warning function will warn the driver if a pre-set maximum speed is exceeded. The system gives a warning buzzer signal if the set speed is 

exceeded by about 10 km/h. A warning symbol will also appear in the display ⇒ Fig. 56.

The speed warning function has **two different warning speeds**, which operate independently and serve slightly different purposes:

#### Speed limit warning 1 ⊖

With speed limit warning 1, the maximum speed can be changed while driving. The speed limit that has been set remains stored until the ignition is switched off, or until it is changed or cleared.

The warning symbol ⊖ for speed limit warning 1 ⇒ Fig. 56 will appear in the display if you exceed the pre-set speed. It goes out again if the speed is reduced below the set speed limit.

The symbol also goes out if the speed is *increased* to more than about 40 km/h above the set speed for at least 10 seconds. However, this does not cancel the speed limit that was originally set.

Setting speed limit warning 1 ⇒ page 86.

#### Speed limit warning 2 ⊖

With speed limit warning 2, the speed limit can only be changed or cleared when the ignition is switched off. You are recommended to store this speed limit warning if you *always* wish to be reminded of a particular speed limit. This could be when driving in countries with general speed limits, or if a particular speed should not be exceeded when winter tyres are fitted etc.

The speed limit warning symbol ⊖ for speed warning 2 will appear in the display if you exceed the pre-set speed. Unlike speed limit warning 1, the warning symbol only goes out once the road speed has dropped below the set value again.

Setting speed limit warning 2 ⇒ page 87.



#### Note

Please bear in mind that, even with the speed warning function, it is still important to keep an eye on the vehicle's speed with the speedometer and to observe the legal speed limits. ■

## Setting speed limit warning 1

Use the CHECK button to set speed limit warning 1.



Fig. 57 Detailed view of the instrument panel: CHECK button

#### Setting the speed limit

- Drive at the desired maximum speed.
- Press the CHECK button and hold it down until the symbol ⇒ Fig. 56 appears.

#### Clearing the speed limit

- Drive the vehicle at a minimum of 5 km/h. ▶

- Press the CHECK button for at least two seconds.

The speed warning symbol  $\ominus$  lights up briefly in the display when the button is released to confirm that the selected speed has been stored. The speed limit that has been selected remains stored until another speed is selected with a brief push of the button, or until the memory is cleared with a long push of the button. ■

### Setting speed limit warning 2

*Speed limit warning 2 is set using the switches on the windscreen wiper lever.*

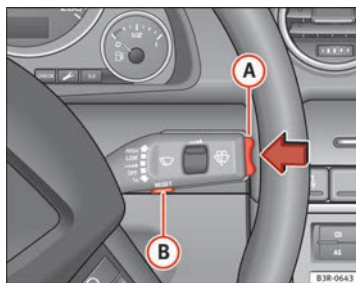

**Fig. 58** Windscreen wiper lever: Function selector switch

#### Setting the speed limit

- Switch the ignition off.
- Briefly press the CHECK button in the instrument panel ⇒ Fig. 57. The odometer and the digital clock will light up.

- Press the CHECK button for at least two seconds. The display will show the speed limit which is currently set or, if no speed limit has been set, the crossed out warning symbol for speed limit 2.
- To change the speed limit, press the top or bottom of the function selector switch on the windscreen wiper lever (A) ⇒ Fig. 58. The speed limit displayed will then increase or decrease by 10 km/h at a time.

#### Clearing the speed limit

- Switch the ignition off.
- Briefly press the CHECK button in the instrument panel ⇒ Fig. 57. The odometer and the digital clock will light up.
- Press the CHECK button for at least two seconds. The display will show the speed limit which is currently set.
- Now press and hold the Reset button on the windscreen wiper lever (B) ⇒ Fig. 58 until the crossed out warning symbol for speed limit 2 appears on the display.

The display lighting for the odometer and digital clock goes off again a few seconds after the button is released. ■

## Onboard computer

### Introduction

The onboard computer provides you with useful information during a journey, including average and current fuel consumption, average speed, distance to empty, driving time and distance covered.

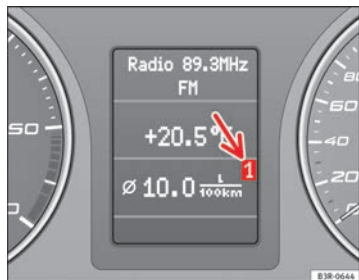

Fig. 59 Onboard computer: memory 1

Press RESET button **(B)** ⇒ Fig. 60 to switch back and forward between onboard computer functions 1 and 2.

The numbers in the display ⇒ Fig. 59 indicate which of the two memories is currently in use. A **1** means that the display is showing the information in the single journey memory (onboard computer 1). A **2** means that the display is showing the information in the total journey memory (onboard computer 2).

### Single-journey memory (onboard computer 1)

The single-journey memory processes the information on a journey from the time the ignition is switched on until it is switched off. If the journey is resumed **within two hours** after the ignition is switched off, the new figures are automatically included in the calculation. If the journey is interrupted for **more than two hours** the stored information is automatically erased when you resume your journey.

### Total-journey memory (onboard computer 2)

Unlike the single-journey memory, the total-journey memory is not erased automatically. Hence, you can determine the period for which you wish the onboard computer to supply figures.

### Distance to empty

The estimated distance to empty is displayed in km. The distance to empty is displayed in increments of 10 km.

### Average fuel consumption

This mode shows the average fuel consumption since the memory was last cancelled in litres/100 km.

### Instantaneous fuel consumption

The display shows the instantaneous fuel consumption in litres/100 km. When the vehicle is stationary, the computer will display the last value in the memory.

### Average speed

This mode shows the average speed driven since the memory was last cancelled (in km/h).

### Driving time

This display shows the period of time which has elapsed since the memory was last cancelled. The longest possible period it can cover is 999 hours and 59 minutes. ▶

### Driving time warning

After 2 hours of continuous driving, the display automatically switches over to the driving time display of **2:00**. At the same time the driving time display starts flashing. This is to remind the driver to take a break.

The driving time warning can be switched off by briefly pressing the function selector switch or the **Reset** button ⇒ Fig. 60.

If you continue driving or take a break for less than 10 minutes, the driving time warning will switch on once again when the total driving time is **4:00** hours, **6:00** hours, etc. However, if you take a break for more than 10 minutes, the driving time warning clock will be erased.

### Distance covered

This display shows the distance you have covered since the memory was last cancelled. The longest possible distance which can be recorded is 9999.9 km.



#### Note

- The displays for fuel consumption (average and instantaneous), distance to empty and speed are shown in metric units.
- The information in the memory is lost if the battery is disconnected.

### Operation

*The onboard computer is controlled by means of two switches on the windscreen wiper lever.*

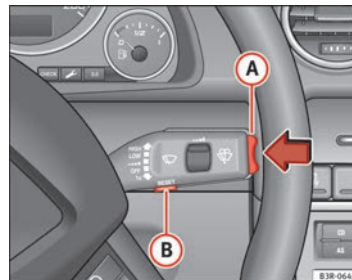

**Fig. 60** Windscreen wiper lever: Onboard computer controls

#### Activating the onboard computer

- Press the reset button **(B)** repeatedly until the onboard computer (memory 1 or 2) ⇒ Fig. 59 is displayed.

#### Selecting the function

- Press the top or bottom of the function selector switch **(A)** ⇒ Fig. 60. This displays the functions of the onboard computer in sequence.

#### Resetting to zero

- Press and hold the Reset button **(B)** for at least two seconds.

The following values can be reset to zero using the Reset button: ▶

- Journey duration
- Distance covered
- Average fuel consumption
- Average speed

The onboard computer can only be operated when the ignition is switched on. When the ignition is switched on, the display shows the function that was last selected.

As well as the figures from the onboard computer (1 or 2), the display can also show information from the navigation system\*. Press the Reset button **B** briefly to switch back and forward between these displays.

**Note**

- If you keep the Reset button pressed for longer than two seconds, it will reset the currently displayed figure to zero (for instance average fuel consumption).
- Faults detected by the auto-check control will be displayed even if the display is off.
- The information in the memory is lost if the battery is disconnected. ■

## Menu display

### Introduction



Fig. 61 Windscreen wiper lever: Menu selection button



Fig. 62 Display: Main menu

Some of your vehicle's functions can be adjusted, activated and controlled by **menus**. With the aid of the menus you can then also select the information you wish to see displayed on the DIS display. This is **only** possible when the ignition is on. The menu is enabled using the **Reset** button on the windscreen wiper lever ⇒ Fig. 61.

The **main menu** lists the different display types (or basic commands):

#### Programming

#### Check

#### Menu off

#### Help

The main menu options have the following submenus:

<b>Programming</b>	Clock	⇒ page 92
	Computer	⇒ page 92
	Speed warning	⇒ page 85
	Radio info (on/off)	
	Units (measuring distance, fuel consumption, temperature)	⇒ page 92
	Language: you can select one of 6 languages.	⇒ page 92
<b>Check</b>	Service	⇒ page 77
<b>Menu off</b>	When the menu is switched off, the display shows the same information as in vehicles without the menu function.	
<b>Help</b>	The help function may be used to understand the meaning of symbols that can appear on different menus.	

## Controlling the menu

The menu display is called up via the **Reset** button and the rocker switch on the windscreen wiper lever. Use these controls to make checks and adjust the settings.

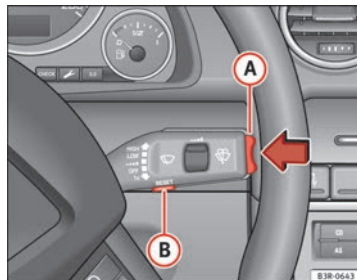

Fig. 63 Windscreen wiper lever: Reset button and rocker switch

Functions of the **Reset** **B** ⇒ Fig. 63 and the **rocker switch** **A**:

### Activating the menu

- Press the **Reset** button until the menu display ⇒ Fig. 62 appears.

### Selecting and setting

- Press the rocker switch to select one of the menus. Press "up" or "down" on the switch to select the options accordingly.

### Entering and confirming

- Press the **Reset** button.

Use the rocker switch to select the menus and adjust various values. The selected values are highlighted on a red background.

By pressing the **Reset** button, you can confirm the option you have selected or the value you have set. Selected functions are marked with a tick.

The following symbols are used:

Cursor	Function selected	Red background (active function)
✓	Tick	Selected
☐	Box	Not selected
▲	Triangle pointing upwards	Previous page
▼	Triangle pointing downwards	Next page

## Tyre pressure monitoring\*

### Introduction

*The tyre pressure monitoring system constantly checks the pressure of the tyres.*

The system warns the driver in the event of a loss of pressure by means of symbols and messages in the instrument panel display. The system works with the help of the ABS sensors in the wheels.

Please bear in mind that the tyre inflation pressure is also influenced by the temperature of the tyre. Tyre pressure increases about 0.1 bar for each 10°C in tyre temperature increase. The tyre heats up while the vehicle is being ►

driven and the tyre pressure will rise accordingly. Therefore, you should only adjust the tyre pressures when they are *cold* (i.e. approximately at ambient temperature).

To ensure that the tyre pressure monitoring system works reliably, you should check and, if necessary, adjust the tyre pressures at regular intervals and store the correct pressures (reference values) in the system.

A tyre pressure information label is attached to the inside of the fuel tank flap.



#### WARNING

- **Never adjust tyre pressure when the tyres are hot. This may damage or even burst the tyres. Risk of accident!**
- **An insufficiently inflated tyre flexes a lot more at high speeds and causes significant heating of the tyre. Under these conditions, the tyre bead may be released or the tyre may burst. Risk of accident!**



#### For the sake of the environment

Under-inflated tyres lead to increased fuel consumption and tyre wear.



#### Note

- Responsibility for ensuring that the tyres are correctly inflated remains with the driver; the system can only provide assistance.
- Pressure can only be adjusted when the tyres are at ambient temperature. ■

### Tyre pressure monitoring display (L)

*The tyre pressure should be corrected as soon as possible if it is too low.*

If the (L) symbol appears, the tyre pressure on at least one of the wheels is too low.

- Stop the vehicle.
- Check the tyre(s).
- Correct the tyre pressure ⇒ page 250.

For more detailed information on the tyre pressure monitoring system, please refer to ⇒ page 249. ■

## Steering wheel controls

### Multifunction steering wheel\*

#### Introduction

You can use the multifunction steering wheel to quickly and easily operate selected functions of the radio, CD, and telephone\*.

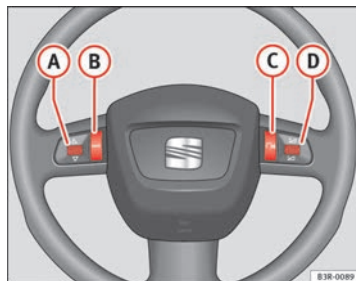

Fig. 64 Controls on the multifunction steering wheel

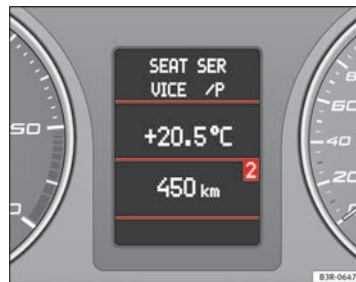

Fig. 65 Driver information system

The functions are operated by pressing or scrolling the controls **A** to **D** on the multifunction steering wheel ⇒ Fig. 64:

- Press the **[MODE]** button **B** repeatedly to switch between modes, which are then displayed in the driver information system ⇒ Fig. 65.
- Scroll and press the left thumbwheel **A** to select a function from one of the menus.
- The speech control system\* for the on-board phone system is enabled by pressing the talk button **C**. Pressing the talk button again disables speed control\*.
- Scroll the right thumbwheel **D** up/down to increase/decrease the volume.

### Steering wheel audio version controls

	A			B (Mode)	C (PTT)	D		
	+	-	Press			+	-	Press
<b>Radio mode</b>	Station search. Increase frequency	Station search. Decrease frequency	Press once: starts the search. Press twice: cancels the search	Long press: block the steering wheel controls	No function specified	Volume up	Volume down	MUTE
<b>CD/ iPod-USB Mode</b>	CD mode: next track. iPod/USB Mode: next track	CD mode: previous track. iPod/USB Mode: previous track	CD mode: fast forward. iPod/USB Mode: fast forward	Short press: activates the steering wheel controls (if they are blocked / without specific function (if they are not blocked))		Volume up	Volume down	MUTE
<b>MP3 mode</b>	Next track	Previous track	Fast forward			Volume up	Volume down	MUTE

## Steering wheel Audio + Telephone version controls

	Ⓐ			Ⓑ (Mode)	Ⓒ (PTT)	Ⓓ		
	+	-	Press			+	-	Press
<b>Radio mode</b>	Station search. Increase frequency	Station search. Decrease frequency	Press once: starts the search. Press twice: cancels the search	Change to phone	Enable voice recognition	Volume up	Volume down	MUTE
<b>CD/ iPod-USB Mode</b>	CD mode: next track. iPod/USB Mode: next track	CD mode: previous track. iPod/USB Mode: previous track	CD mode: fast forward. iPod/USB Mode: fast forward			Volume up	Volume down	MUTE
<b>MP3 mode</b>	Next track	Previous track	Fast forward			Volume up	Volume down	MUTE
<b>Phone mode</b>	Next name in phone book	Previous name in phone book	Accept	Change to radio / CD / iPod-USB / MP3	Volume up	Volume down	No function specified	
<b>Incoming call mode</b>	No function specified	No function specified	One press: accept call. Held down: reject call	No function specified	No function specified	Volume up	Volume down	No function specified
<b>Active call mode</b>	No function specified	No function specified	End call	No function specified	No function specified	Volume up	Volume down	No function specified
<b>Voice activation mode</b>	No function specified	No function specified	No function specified	No function specified	Cancel	Volume up	Volume down	No function specified

## Steering wheel controls, Navigation System\* version

	A			B (Mode)	C (PTT)	D		
	+	-	Press			+	-	Press
<b>Radio mode</b>	Station search. Increase frequency	Station search. Decrease frequency	Press once: starts the search. Press twice: cancels the search	No function specified	No function specified	Volume up	Volume down	Repetition of the last navigation order (only if active)
<b>CD/ iPod-USB Mode</b>	CD mode: next track. iPod/USB Mode: next track	CD mode: previous track. iPod/USB Mode: previous track	CD mode: fast forward. iPod/USB Mode: fast forward			Volume up	Volume down	Repetition of the last navigation order (only if active)
<b>MP3 mode</b>	Next track	Previous track	Fast forward			Volume up	Volume down	Repetition of the last navigation order (only if active)

## Steering wheel controls, Navigation System + Telephone\* version

	A			B (Mode)	C (PTT)	D		
	+	-	Press			+	-	Press
<b>Radio mode</b>	Station search. Increase frequency	Station search. Decrease frequency	Press once: starts the search. Press twice: cancels the search	Change to phone	Enable voice recognition	Volume up	Volume down	Repetition of the last navigation order (only if active)
<b>CD/ iPod-USB Mode</b>	CD mode: next track. iPod/USB Mode: next track	CD mode: previous track. iPod/USB Mode: previous track	CD mode: fast forward. iPod/USB Mode: fast forward			Volume up	Volume down	Repetition of the last navigation order (only if active)
<b>MP3 mode</b>	Next track	Previous track	Fast forward			Volume up	Volume down	Repetition of the last navigation order (only if active)
<b>Phone mode</b>	Next name in phone book	Previous name in phone book	Accept	Change to radio / CD / iPod-USB / MP3	Volume up	Volume down	Repetition of the last navigation order (only if active)	
<b>Incoming call mode</b>	No function specified	No function specified	One press: accept call. Held down: reject call	No function specified	No function specified	Volume up	Volume down	Repetition of the last navigation order (only if active)
<b>Active call mode</b>	No function specified	No function specified	End call	No function specified	No function specified	Volume up	Volume down	Repetition of the last navigation order (only if active)
<b>Voice activation mode</b>	No function specified	No function specified	No function specified	No function specified	Cancel	Volume up	Volume down	No function specified

## Unlocking and locking

### Remote control keys

#### Set of keys

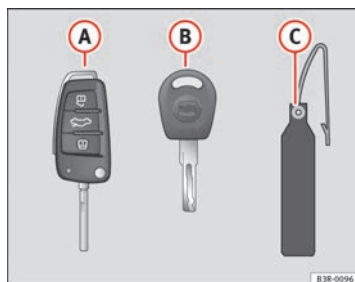

Fig. 66 Set of keys supplied with the vehicle



Fig. 67 Remote control key: Release button

The set of keys belonging to your vehicle consists of the following items:

- Ⓐ one remote control key.
- Ⓑ one key without remote control.
- Ⓒ a plastic key tab\*.

#### Remote control key

The remote control key will lock and unlock the vehicle and start the engine. Press the release button ⇒ Fig. 67 (arrow) to make the key spring out of the handle and to fold it back in.

#### Replacing a key

If you lose a key, please contact the Technical Service. Have the remote control coding for *that* key disabled. You should therefore bring the plastic key tab\* and all available keys with you. It is also important to notify your insurance company if a key or the plastic key tab has been lost. ▶

### 2 remote control keys

In certain European markets, vehicles with alarm are equipped with 2 remote control keys.

#### WARNING

- Always take the key with you when leaving the vehicle, even if you only intend to be gone for a short time. This is particularly important if there are children in the vehicle, as they might otherwise be able to start the engine or use power-operated equipment (e.g. the electric windows), which could cause injuries.
- Wait for the vehicle to come to a standstill before removing the ignition key from the lock! Otherwise, the steering lock could engage suddenly, causing an accident.

### Indicator light on the remote control key

The condition of the battery in the remote control key is monitored by the indicator light.



Fig. 68 LED on the remote control key

### Condition of the key battery

The indicator light ⇒ Fig. 68 (arrow) flashes when one of the buttons is pressed. If the indicator light does not light up or flash, this means that the battery is exhausted and must be replaced.

Replacing the batteries ⇒ page 100.

### Replacing the key battery

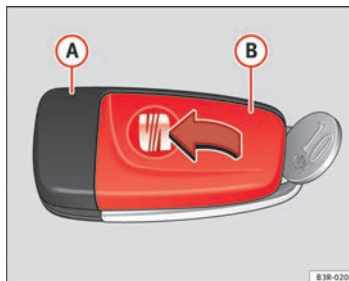

Fig. 69 Master key: Opening the cover

We recommend you have the batteries changed in a specialised workshop. If you decide to change the battery used in a yourself, follow the steps below:

- **Carefully** prise apart the key ⇒ Fig. 69 (A) and the cover (B) using a coin.
- Remove the cover in the direction of the arrow.
- Remove the used battery from the cover.

- Insert the new battery. Make sure that the “+” symbol on the battery is facing downwards. The correct polarity is indicated on the cover.
- After inserting the battery, align the cover and key and press the two parts together.



### For the sake of the environment

Used batteries must be disposed of at an appropriate waste facility or through an authorised service, given that their components can affect the environment.



### Note

- The system must be re-synchronised after each battery replacement to be able to lock and unlock the vehicle using the remote control ⇒ page 109.
- The new battery must be of the same type as the original.

## Electronic immobiliser

*The electronic immobiliser is designed to prevent unauthorised persons from starting up the vehicle.*

There is an electronic chip inside the key which automatically deactivates the immobiliser when the key is inserted into the ignition lock. The electronic immobiliser is enabled automatically when the ignition key is removed from the ignition lock after coming to a stop.

If an un-coded key is used, the message **SAFE** will appear in the trip recorder display.



### Note

- The engine can only be started using an original SEAT key with the correct code.
- It may not be possible to start the engine with the key if there is another ignition key from a different make of vehicle on the same key tab.

## Central locking

### Description

*The central locking system enables you to lock and unlock all the doors, the rear lid and the tank flap together.*

The central locking system on your vehicle locks and unlocks *all* the doors and the tank flap simultaneously. The rear lid is unlocked when the vehicle is opened. However, the handle must be used to open it. The vehicle can be locked and unlocked using the remote control ⇒ page 108 **or** by turning the key in the lock in the driver door.

The windows can also be centrally opened or closed using the central locking system ⇒ page 114. The sunroof\* can be closed but not opened using the central locking system.

The central locking system is combined with an **anti-theft security system**. If the vehicle is locked with the key from the outside, the interior opening levers stop working, which prevents unauthorised persons from entering the vehicle.

Should the central locking system fail to work, you can activate all the locks individually.

**Automatic locking function (Auto Lock)\***

The **Auto Lock\*** function automatically locks all doors and the rear lid when the vehicle exceeds a speed of about 15 km/h.

The vehicle is unlocked again automatically when the ignition key is removed. Alternatively, the driver can also unlock the vehicle using the central locking switch  or by opening one of the doors.

 **WARNING**

**Do not leave anyone (especially children) in the vehicle if it is locked from the outside and the anti-theft security system is enabled, as the doors and windows cannot then be opened from the inside. Locked doors could delay assistance in an emergency, potentially putting lives at risk.**

**Note**

- Should the central locking system fail to work, you can still lock and unlock the driver door and the rear lid using the key. Locking the doors manually if central locking fails to work ⇒ page 105.
- The anti-theft mechanism and the anti-theft alarm\* cannot be enabled if the central locking is not working.
- **Never leave any valuable items in the vehicle unattended. Even a locked vehicle is not a safe.**

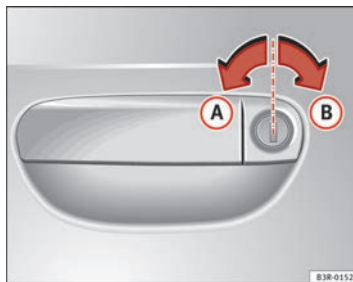
**Unlocking the vehicle with the key**

**Fig. 70** Turning the key to enable the open and close functions

- To unlock the vehicle, turn the key in the driver door to position **A** ⇒ Fig. 70.
- Pull the handle to open the door.
  - This will unlock all the doors, the rear lid and the tank flap simultaneously.
  - The anti-theft security system will be disabled.

**Locking with the key**

- To lock the vehicle, turn the key in the driver door to position **B** ⇒ Fig. 70 ⇒ . ▶

- This will lock all the doors and the rear lid.
- The interior lights are switched off, provided the light switch is in the courtesy light position.
- The windows and the sunroof\* will close as the key is *held* in the locking position.
- The anti-theft security system will be enabled immediately.

#### Locking the vehicle without activating the anti-theft security system

With the anti-theft security system enabled, it is more difficult to break into the vehicle. If the anti-theft security system has been enabled, the inside door handles and the central locking switch will not work ⇒ ⚠.

If you are leaving passengers in the vehicle while it is parked, it is possible to lock the vehicle without activating the anti-theft security system.

To do so, turn the key in the driver door **twice** in quick succession to position **B** ⇒ Fig. 70.

**⚠ WARNING**

Do not leave anyone (especially children) in the vehicle if it is locked from the outside and the anti-theft security system is enabled, as the doors and windows cannot then be opened from the inside. Locked doors could delay assistance in an emergency, potentially putting lives at risk.

#### ⚠ CAUTION

If the driver door is locked using the key while open, the vehicle will be automatically immobilised and the alarm triggered.

#### **i** Note

- Please note that when the vehicle is locked without activating the anti-theft mechanism, the anti-theft alarm\* remains operative. You should therefore switch off the interior monitoring\* before locking the vehicle, as otherwise the alarm\* could be triggered unintentionally.
- The driver door cannot be locked using the central locking system when it is still open. The door must be locked separately after it has been closed. This helps to prevent you from being locked out of the vehicle. ■

### Central locking switch

*The central locking system can be enabled from inside the vehicle using the central locking switch on the driver door.*



Fig. 71 Detail of the driver door: Central locking switch

#### Locking the vehicle

- Press button  ⇒ Fig. 71 ⇒ ⚠.

### Unlocking the vehicle

- Press button .

Please note the following when using the central locking switch to lock your vehicle:

- The doors and the rear lid cannot be opened from the *outside* (for security reasons, e.g. when stopped at traffic lights).
- You can open the doors individually from the inside by pulling the inside door handle.
- When the driver door is open, it cannot be locked by pressing the central locking switch and then closing the door. This helps to prevent you from being locked out of the vehicle. The door has to be locked separately after it has been closed.
- In the event of an accident in which the airbags inflate, doors locked from the inside will be automatically unlocked to facilitate access and assistance.



#### WARNING

The central locking switch is still operative when the ignition is switched off. This switch can be used to automatically lock all the doors and the rear lid. However, since this makes it difficult to enter the vehicle from the outside, you should never leave children unattended in the vehicle. Locked doors could delay assistance in an emergency, potentially putting lives at risk.



#### Note

The central locking switch inside the vehicle will not be operative if the anti-theft mechanism has been enabled.

### Security central locking\*

*The security central locking feature allows you to only unlock the driver door and the tank flap. All other doors and the rear lid remain locked.*

#### Unlocking the driver door and tank flap

- Turn the key *once* to the unlock position, or press the unlock button on the remote control *once*.

#### Unlocking all the doors, the rear lid and the tank flap simultaneously.

- Turn the key *twice* within five seconds, or press the unlock button on the remote control *twice* within five seconds.

The security system and the anti-theft alarm\* are immediately disabled if you unlock only the driver door, without unlocking the other doors  
⇒ page 110.

### Locking the doors manually if the central locking fails to work

*Should the central locking system fail to work at any time (for instance if there is no electrical power supply), each door will have to be locked separately.*

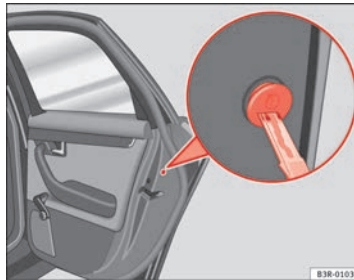

**Fig. 72** Manual locking device



**Fig. 73** Activating manual locking

A manual locking device is provided on the front passenger door and the rear doors (only visible when the door is open).

- Open the door.
- Use the key ⇒ Fig. 72 to turn the cap slightly and then fold it downwards.
- Insert the key into the slot inside ⇒ Fig. 73 and turn it as far as the stop, i.e. about 90 degrees to the right (doors on right side) or to the left (door on the left side).

Once the door has been closed it can no longer be opened from the outside. The door can be opened from the inside by pulling the door handle. If the childproof lock is engaged on one of the rear doors, the door can be opened by pulling the inside door handle once and then opening the door from the outside. ■

## Rear lid

### Rear lid: opening and closing

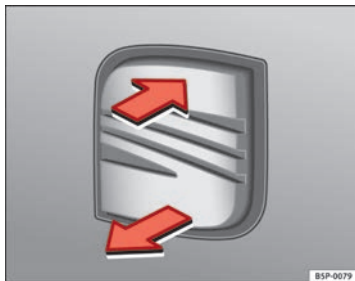

Fig. 74 Luggage compartment: opening from the outside

#### Opening the rear lid

- Pull on the release lever ⇒ Fig. 74 and lift the rear lid at the same time.
- Then lift up the rear lid. If your vehicle is equipped accordingly, the rear lid will open automatically\*.

#### Closing the rear lid

- Pull down the rear lid and let it drop into the latch ⇒ ⚠.

Use the recessed handle in the interior trim to make it easier to pull down the rear lid.



#### WARNING

- After closing the rear lid, always check that the catch has engaged properly. If not, the rear lid could open while driving, even if it has been locked. Risk of accident!
- The rear lid must always be completely closed when the vehicle is moving, otherwise toxic exhaust fumes may be drawn into the vehicle. Danger of poisoning!



#### Note

- The door/rear lid warning symbol lights up on the instrument panel display if the rear lid is not properly closed when the ignition is switched on ⇒ page 77.

### Unlocking the rear lid manually

The rear lid can be released manually if it will not open in the normal way.

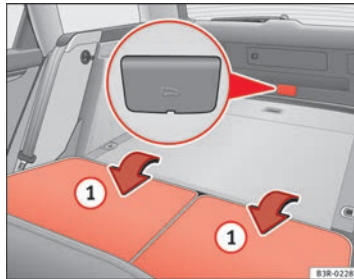

Fig. 75 Detail of the rear seats and luggage compartment: access to the emergency release mechanism

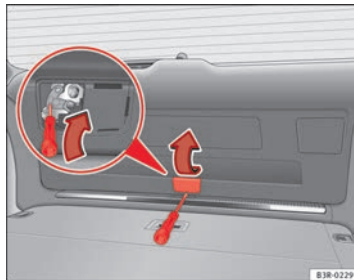

Fig. 76 Detail of the rear lid: emergency unlocking mechanism

- Fold down both rear backrests ① ⇒ Fig. 75.

- Lean into the luggage compartment.
- Lift the cover ⇒ Fig. 76 (arrow).
- Insert the screwdriver into the opening ⇒ Fig. 76 (arrow) and push it in the direction of the arrow in order to release the rear lid.

### Childproof lock

#### Childproof locks on rear doors

The childproof lock prevents the rear doors from being opened from the inside.

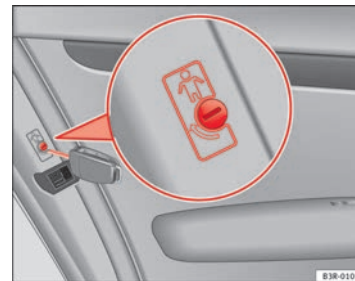

Fig. 77 Childproof lock on the rear doors

The rear doors are equipped with childproof locks. These can be operated using the ignition key. The childproof locks are only visible with the doors open.

### Activating the childproof lock

- Turn the key in the direction of the arrow ⇒ Fig. 77.

### Deactivating the childproof lock

- Turn the key in the opposite direction of the arrow.

When the childproof lock is enabled, the inside door handle will not work and the door can only be opened from the outside.

## Remote control key

### Description

*The remote control key will lock and unlock the vehicle without having to insert the key in the lock.*

The following functions are available:

- Locking and unlocking the vehicle
- Unlocking the rear lid

All the turn signals will flash as confirmation when the vehicle is locked or unlocked. Furthermore, the interior lights will automatically light up when the vehicle is unlocked and go out when the vehicle is locked, provided that the switches are in the courtesy light position.

The remote control transmitter and the battery are integrated into the handle of the key. The receiver is in the interior of the vehicle. The maximum range depends on different circumstances. The range is reduced when the battery starts to lose power.

The remote control incorporates a foldaway key that can be used to manually lock or unlock the vehicle, as well as to start the engine.

If the receiver has been repaired or replaced, or if a replacement key is used, the system will need re-programming by a specialised workshop. Only then will you be able use the remote control again.

The remote control meets all relevant authorisation requirements and has been approved by the Federal Approvals Office for Telecommunications of the Federal Republic of Germany. All components are marked in accordance with the current legal requirements. This certification forms the basis for official approval for use in other countries.



### Note

- The remote control is automatically disabled when the ignition is switched on.
- The function of the remote control may be impaired by interference from other nearby radio signals (e.g. from a mobile phone or TV transmitter) if these are in the same frequency range.

### Locking and unlocking the vehicle

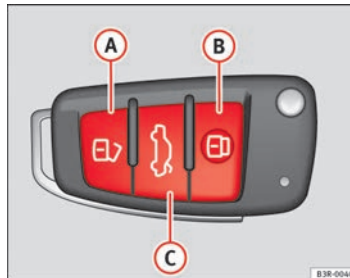

Fig. 78 Remote control key: Control buttons ▶

**Unlocking the vehicle** 

- Press button **A** ⇒ Fig. 78 for about 1 second.

**Locking the vehicle** 

- Press button **B** for about 1 second.

**Opening the rear lid** 

- Press button **C** and hold for at least one second.

The turn signals will flash twice as confirmation when you unlock the vehicle. The vehicle will be locked again automatically if you do not open one of the doors or the rear lid within 60 seconds after unlocking the vehicle with button **A**. This function prevents the vehicle from remaining unlocked if the unlocking button is pressed by mistake.

In vehicles with the **security central locking\*** feature, you can unlock just the driver door and the tank flap by pressing button **A** once or the whole vehicle by pressing the button twice.

The turn signals flash once when the vehicle is locked to confirm that the doors and rear lid are properly locked.

Moreover, apart from unlocking the vehicle, the seat\* and mirror\* memory programmed in the key is activated. The driver seat and exterior mirrors will be automatically adjusted to the positions stored in the memory.

The interior lights will automatically light up when the vehicle is unlocked and go out when the vehicle is locked, provided that the switch is in the courtesy light position.

 **WARNING**

**Do not leave anyone (especially children) in the vehicle if it is locked from the outside and the anti-theft security system is enabled, as the doors and windows cannot then be opened from the inside. Locked doors could delay assistance in an emergency, potentially putting lives at risk.**

 **Note**

- The remote control should only be used when the doors and the rear lid are closed.
- The remote control should not be used when the vehicle is out of sight.
- The anti-theft alarm\* can be accidentally triggered and the vehicle locked if you press the locking button **B** on the remote control inside the vehicle before inserting the key in the ignition. If this should happen by mistake, press the unlock button **A**.

**Re-synchronising**

*Should the remote control fail to lock or unlock the vehicle, the system must be re-synchronised.*

- If the vehicle is locked, use the key to unlock the driver door.
- Press the unlock button **A** on the remote control.
- Insert the key into the ignition and switch on the ignition.
- Switch off the ignition and remove the key.
- Press the unlock **A** or the lock button **B**.

## Anti-theft alarm system\*

### Description

*The system triggers an alarm if anyone attempts to break in to the vehicle.*

The anti-theft alarm helps to prevent the vehicle being broken into or stolen. If the system senses interference with the vehicle, it triggers an audible and visible alarm.

#### How is the system enabled?

The anti-theft alarm system is enabled automatically when the vehicle is locked with the remote control or by turning the key in the driver door (if the door is closed). The anti-theft alarm is enabled about 30 seconds after the vehicle is locked.

#### How is the system disabled?

The anti-theft alarm is only disabled when the vehicle is unlocked using the remote control. The vehicle will lock again automatically if none of the doors is opened within 60 seconds after pressing the remote control button.

If the vehicle is unlocked by turning the key in the driver door, all the other doors, the rear lid and the tank flap will remain locked.

If the vehicle has been unlocked with the key in the driver door, the key must be inserted in the ignition lock and the ignition switched on within 15 seconds of opening the door in order to disable the alarm. **The alarm will be triggered** if the ignition is **not** switched on within 15 seconds.

#### Opening and closing function in cars with alarm

When using the key only without remote control to lock and unlock:

- in unlocking all the doors, they unlock simultaneously.

When using the key only without remote control to lock and unlock:

- in unlocking all the doors, they unlock simultaneously.

When combining locking using the remote control key and unlocking using the key but without the remote control:

- when unlocking, only the driver door will unlock.

#### When does the system trigger the alarm?

The following parts of the vehicle are monitored when the vehicle is locked:

- Engine compartment (bonnet)
- Luggage compartment
- Doors
- Tilt angle (tow-away protection)
- Ignition
- Radio (only with a factory-fitted SEAT radio)
- Interior ⇒ page 111

If any of these areas are entered, the alarm will be triggered.

#### How is the alarm disabled?

The alarm can be switched off by unlocking the vehicle using the remote control, or by switching on the ignition with the key, thus “disabling” the alarm system. The alarm will also switch off when it comes to the end of its cycle.

#### Turn signals

The turn signals flash briefly when the vehicle is locked to confirm that the doors, the engine bonnet and the rear lid are properly closed and locked.

If the turn signals do not flash, check the doors, the bonnet and the rear lid to make sure they are properly closed. The turn signals will also flash briefly if one of the doors or the rear lid or engine bonnet is closed after the alarm system has been enabled. ▶

**LED**

When the vehicle is locked, the LED on the top of the driver door trim will flash rapidly for about 30 seconds and then continue flashing slowly. This is to indicate that the anti-theft alarm system (including the **interior monitoring** and **tow-away protection**) is operative. If the LED lights up continuously for about 30 seconds when the vehicle is locked instead of flashing, this means the alarm system is not working properly.

**Note**

- To make sure that the alarm is fully operative when leaving the vehicle, briefly check that all the doors and windows and the sunroof\* are closed.
- The alarm is triggered immediately if one of the battery cables is disconnected while the alarm system is enabled. ■

**Interior monitoring\* **

*The interior monitoring triggers an alarm if it detects movement inside the vehicle.*

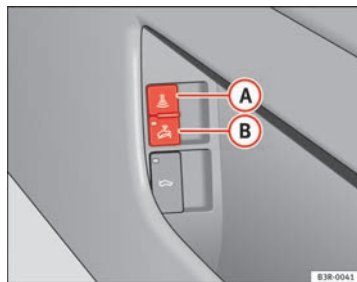

**Fig. 79 Interior monitoring switch**

You should disable the interior monitoring if there is a possibility that the alarm could be triggered, e.g. by a pet or by an object moving inside the vehicle ⇒ . The tow-away protection feature, which is integrated into the alarm system, should be disabled if the vehicle is being towed or transported (e.g. by rail or ship).

**Deactivating the interior monitoring**

- Open the door and pull out the switch **A** (with the symbol ) to one side of the storage compartment, in the driver door ⇒ Fig. 79.
- Then lock the vehicle.

**Deactivating the tow-away protection**

- Open the door and pull out switch **B** (with the symbol ) to one side of the storage compartment, in the driver door ⇒ Fig. 79.
- Then lock the vehicle.

The LED on switch **A** will light up when the **interior monitoring** is disabled. The LED on the top of the driver door trim will also light up for about 3 seconds. When the vehicle is locked, the LED on the top of the driver door trim will flash rapidly for about 3 seconds. About 30 seconds later it starts flashing slowly. The interior monitoring is automatically enabled again the next time the vehicle is locked.

The LED on switch **B** will light up when the **tow-away protection** function is disabled. The LED on the top of the driver door trim will also light up for about 3 seconds. When the vehicle is locked, the LED on the top of the driver door trim will flash rapidly for about 3 seconds. The tow-away protection is automatically enabled again the next time the vehicle is locked. ►

**! WARNING**

Do not leave anyone (especially children) in the vehicle if it is locked from the outside and the anti-theft security system is enabled, as the doors and windows cannot then be opened from the inside. Locked doors could delay assistance in an emergency, potentially putting lives at risk.

## Electric windows

### Controls

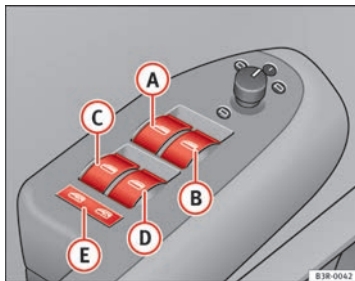

Fig. 80 Detail of the driver door: Controls

#### Switches for front electric windows

- A** Switch ⇒ Fig. 80 for the driver door window
- B** Switch for the front passenger door window.

#### Switches for rear electric windows

- C** Switch for the rear left door window
- D** Switch for the rear right door window
- E** Safety switch

**! WARNING**

- Always take the key with you when leaving the vehicle, even if you only intend to be gone for a short time. This is particularly important if there are children in the vehicle, as they might otherwise be able to start the engine or use power-operated equipment (e.g. the electric windows), which could cause injuries. The electric window switches are only disabled when the driver door or the front passenger door is opened.
- Never close the windows in a careless or uncontrolled manner, as there is a risk of causing injuries.
- When locking the vehicle from the outside, make sure that nobody is inside the vehicle, as the windows cannot be opened from the inside in an emergency.

### Switches on the driver door

The driver can operate all the electric windows in the vehicle.

The electric windows are controlled by **two-stage switches**:

#### Opening the windows

- Press the switch as far as the **first stop** and hold it until the window has moved to the desired position.
- Press the switch briefly **to the second stop** and the window will automatically open all the way. ▶

### Closing the windows

- Pull the switch as far as the **first stop** and hold it until the window has moved to the desired position.
- Pull the switch briefly **to the second stop** and the window will automatically close all the way.

### Safety switch

The safety switch ⇒ Fig. 80 (E) can deactivate the rear door switches. The windows can only be operated from the rear when the safety switch is pressed in.

The symbol  lights up on the safety switch when the electric windows in the rear doors are disabled (switch not pressed in).



### Note

The windows will work for about ten minutes after the ignition has been switched off. The electric window switches are only disabled when the driver door or the front passenger door is opened.

### Switches on the front passenger's door and rear doors

*Each of these doors has a switch for its own window.*

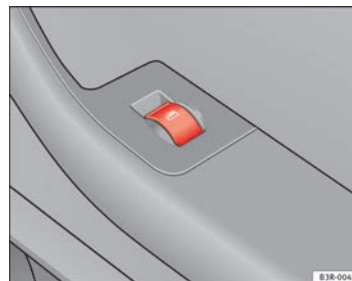

Fig. 81 Switch on front passenger door

The electric windows are controlled by **two-stage switches**:

### Opening the windows

- Press the switch as far as the **first stop** and hold it until the window has moved to the desired position.
- Press the switch briefly **to the second stop** and the window will automatically open all the way.

### Closing the windows

- Pull the switch as far as the **first stop** and hold it until the window has moved to the desired position.
- Pull the switch briefly **to the second stop** and the window will automatically close all the way.

**Note**

The windows will work for about ten minutes after the ignition has been switched off. The electric window switches are only disabled when one of the front doors is opened.

### Opening and closing the windows using the central locking function

*The windows can be opened or closed simultaneously when the vehicle is unlocked or locked.*

#### Opening the windows using the remote control

- Press and hold the unlock button  on the remote control until the windows reach the desired position.

#### Opening the windows using the ignition key

- Unlock the driver door with the key and hold the key in the unlock position until all the windows are open.

#### Closing the windows using the remote control

- Press and hold the lock button  until all windows are closed ⇒ .

#### Closing the windows using the ignition key

- Lock the driver door with the key and hold the key in the lock position until all the windows are closed ⇒ .

The windows will stop moving when you release the remote control button or turn the key back to its initial position in the door lock.

**WARNING**

- Be careful when closing the windows to ensure nobody is hurt.
- For safety reasons, you should only use the remote control open and close functions within about 2 metres of the vehicle. To avoid injuries, always keep an eye on the windows when pressing the button to close them. The windows stop moving as soon as the button is released.

### Possible malfunctions

#### Automatic open and close function not working

The automatic open and close function will not work if the battery has been temporarily disconnected. The function can be restored as follows:

- Close the window as far as it will go by lifting and holding the window switch.
- Release the switch and then lift it again for one second. This will re-enable the automatic function.

### Sliding/tilting sunroof\*

#### Description

The sliding/tilting sunroof is operated using the rotary knob ⇒ Fig. 82. The rotary knob for sliding the roof open can be adjusted to several different settings (with click stops). This knob only works when the ignition is switched on. The rotary knob must be in the  position if you want to tilt the roof up at the rear. ▶

The sunroof will work for about ten minutes after the ignition has been switched off. However, it is immediately disabled when one of the front doors is opened.

### Opening/Tilting

*The sunroof will create less wind noise if it is opened in the convenience position.*



Fig. 82 Detail of headliner: Sliding/tilting sunroof control

#### Convenience position

- Turn the control until it engages at position ① ⇒ Fig. 82. The sunroof will now only open as far as the convenience position which means there is less wind noise.

#### Opening completely

- Turn the switch to position ② and hold it until the sunroof reaches the desired position. This position can cause more wind noise.

#### Tilting open

- Turn the control to position ①.
- With the control in position ①, press the control *briefly* to make the roof tilt open *all the way*.
- To open the roof as far as an *intermediate* setting, *press and hold* the control until the roof has moved to the desired position.

When you release the switch it will automatically spring back from position ② to position ①.

The sliding sun blind in the headliner automatically opens when the sunroof is slid open. If required, it can be closed by hand when the sunroof is closed.

It is advisable to close the sun blind when the vehicle is left standing in the sun. It is important to remember to close the sunroof when parking the vehicle or if it suddenly starts raining, especially when the sun blind is closed.

For further information on the automatic close function, see ⇒ page 116.

### Closing

#### Closing

- Turn the control to position ① ⇒ Fig. 82 to close the sunroof ⇒ △.

#### Closing the sunroof from the tilt position

- Pull the specially formed rear end of the control *and hold it* until the sunroof has moved down to the desired position. ▶

- Pull the switch *briefly* to lower the sunroof automatically to the fully closed position. If required, the sunroof can be stopped in any position by *briefly* pulling the control again ⇒ ⚠.

 **WARNING**

Take care when closing the sunroof. There is a risk of suffering injury. For this reason, always take out the ignition key when leaving the vehicle. ■

### Automatic close function

*The sunroof can also be closed from outside the vehicle.*

- Turn the key in the lock on the driver door and hold it in the lock position or press the lock button on the remote control until the sunroof has closed all the way ⇒ ⚠.

 **WARNING**

Take care when closing the sunroof. There is a risk of suffering injury. ■

### Solar sunroof\*

The solar cells in the sunroof power the air conditioner fan.

The solar sunroof is operated in the same way as the normal sliding/tilting sunroof.

The interior trim is fixed to the solar sunroof and cannot be opened and closed separately. ■

### Emergency electrical activation

*In an emergency it is possible to close the sunroof electronically.*

The sliding sunroof mechanism is equipped with a *safety cut-out*. If the roof should fail to close normally, it can be closed with the emergency function.

- Turn the control to position ① ⇒ Fig. 82.
- Pull on the control switch until the roof closes.

 **WARNING**

Take care when closing the sunroof. There is a risk of suffering injury. For this reason, always take out the ignition key when leaving the vehicle. ■

## Lights and visibility

### Lights

#### Lights: switching on and off ☀



Fig. 83 Detailed view of the dash panel: Light switch

#### Switching on the side lights

- Turn the light switch ⇒ Fig. 83 to position ☀.

#### Switching on dipped or main beam headlights (driving lights)

##### Dipped beam headlights

- Turn the lights switch to position ☀.

##### Main beam headlights

- Turn the lights switch to position ☀.

- Press the main beam lever forward ⇒ page 124.

#### Switching off the lights

- Turn the light switch to position O.

**Daytime running lights:** In vehicles for countries where daytime running lights are obligatory and in all vehicles with AFS headlights, daytime running lights are turned on or off with the ignition. Daytime running lights have main beam flashers, as usual, but not the dipped beam headlight function

The dipped beam headlights will only work with the ignition on. The headlights are automatically switched to side lights after the ignition has been switched off.

If the side lights or the dipped beam headlights are turned on, the ☀ symbol will come on together with the lights switch.



#### Note

- If the lights are left on after the key has been taken out of the ignition lock, a buzzer sounds when the driver door is opened.
- Observe all relevant legal requirements when using the signalling and lighting systems described here.
- Depending on weather conditions (cold or wet), the front lights, the fog lights, the tail lights and the turn signals may be temporarily misted. This has no influence on the useful life of the lighting system. By switching on the lights, the area through which the beam of light is projected will quickly be demisted. However, the edges may continue to be misted. ■

### Automatic headlight switch\* (sensor-controlled)

If you set the light switch to “AUTO”, the dipped headlights will switch on and off automatically according to the ambient light level.



Fig. 84 Detailed view of the dash panel: Light switch

#### Turning on dipped beam headlights

- Turn the light switch → Fig. 84 to the **AUTO** position.

#### Turning off dipped beam headlights

- Turn the light switch to position **O**.

The symbol on the switch lights up when the switch is in the **AUTO** position.

The dipped beams, side lights, tail lights and number plate lights come on together when the headlights are switched on automatically.

When you are using the automatic headlights switch, you can also operate the main beam headlights, however, please note the following: If you enable the main beam headlights while using the automatic headlights function **during the day** (e.g. when driving through a tunnel), but do not disable

them again, only the dipped beam headlights will come on the next time the lights are automatically switched on. To be able to use the main beam headlights again, you must first pull the main beam lever back to the “off” position and then push it forward again to “on”.

The side lights, headlights, fog lights and rear fog light can still be switched on manually in the normal way by using lights switch → page 117.

The interior mirror is fitted with sensors that measure the ambient light. The dipped beam headlights will be switched on automatically if the available light drops below the factory preset value (for instance when driving through a tunnel, etc.). The headlights switch off again automatically when the light level increases ⇒ ⚠.

#### ⚠ WARNING

- The automatic dipped beam headlights are only intended to assist the driver. Automatic dipped beam headlights do not relieve the driver of his or her responsibility to control them and turn off or turn on the lights manually according to weather or lighting conditions. The light sensors are, for example, unable to detect rain and fog - you should therefore always switch on the dipped beam headlights  manually in these conditions and when driving after dark.
- Observe all relevant legal requirements when using the signalling and lighting systems described here.



#### Note





- If automatic headlight switching is activated, when the ignition is turned off the dipped beam headlights are turned off, and when the key is removed from the ignition the side lights are turned off.
- If you have to attach any type of sticker on the windscreen, do not do so in front of the sensors. Doing so could prevent the automatic dipped beam headlight or anti-dazzle function from working correctly or even from working at all. ▶

- The warning symbol  will appear on the instrument panel if a malfunction occurs ⇒ page 84.
- Observe all relevant legal requirements when using the signalling and lighting systems described here.

### Front fog lights

*The light switch can also be used to turn on the front fog lights.*







#### Switching on the front fog lights



- Do  ⇒ Fig. 83 **not** turn the light switch to the symbol .
- First turn the light switch to the position  or .
- Then pull the light switch out to the *first* stop .

The front fog light symbol  next to the switch will light up when the front fog lights are on.

### Rear fog light

*The light switch can also be used to turn on the rear fog light.*

- Do  ⇒ Fig. 83 **not** turn the light switch to the symbol .
- First turn the light switch  ⇒ Fig. 83 to the position  or .
- Then pull out the light switch to the second stop  to switch on the rear fog light.

The symbols  and  next to the switch will light up when the rear fog light is switched on.

If you are towing a trailer or caravan equipped with a rear fog light on a vehicle with a factory-fitted **towing bracket\***, only the rear fog light on the trailer or caravan will light up.

#### CAUTION

To avoid dazzling the traffic behind you, the rear fog light should only be used in accordance with legal regulations.

### Coming home / leaving home function\*

*The coming home and leaving home functions are used to light up the surroundings in the dark. The front fog lights, the rear side lights and the number plate light switch on.*

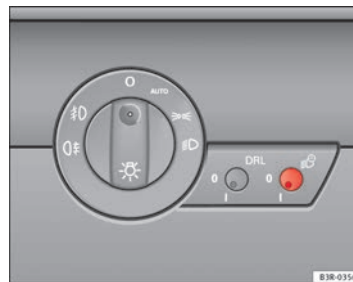

Fig. 85 Detailed view of the dash panel: Coming home and leaving home functions

### Activating the function

- Briefly press the knob ⇒ Fig. 85 to release it from its set position.
- Turn the knob to position 1.
- Press the knob in again to prevent the setting from being changed unintentionally.

### Deactivating the function

- Briefly press the knob ⇒ Fig. 85 to release it from its set position.
- Turn the knob to position 0.
- Press the knob in again to prevent the setting from being changed unintentionally.

The coming home and leaving home functions are controlled by light sensors in the interior mirror housing. The system will function when the following requirements are met:

- The knob is set to position 1.
- The headlights and the ignition are switched off.
- Dark conditions; the sensors register little or no light.

### Coming home

When the system is enabled and it is **dark**, the corresponding exterior lights switch on as soon as the driver door is opened.

The exterior lights will stay on for up to a maximum of 2 minutes as long as one of the doors or the rear lid is open.

The exterior lights stay on for about 30 seconds to light up the area around the vehicle after all the doors and the rear lid have been closed.

This time interval is factory-set, but you can have it changed by a specialised workshop to suit your own requirements (max. setting is 60 seconds).

### Leaving home

The exterior lights are switched on when the vehicle is unlocked with the  button on the remote control key.

The exterior lights go out when the driver door is opened or after 60 seconds when the vehicle locks itself again automatically ⇒ page 108.



### WARNING

**Before leaving the vehicle, remove the key from the ignition, as the lights will not go out if the coming home function is activated. This will lead to battery discharge and vehicle breakdown.**



### Note



- If you always wish to use the coming home and leaving home functions, you can leave them permanently switched on. As the system is controlled via a photosensor, it will only work in dark conditions.
- Permanent use of the coming home and leaving home functions, particularly on short journeys, will increase the load on the battery. To make sure the battery is always sufficiently charged, occasionally drive longer distances.
- If the fog lights have been switched on by the coming home and leaving home functions, they will always be switched off when you switch on the ignition.
- Observe all relevant legal requirements when using the signalling and lighting systems described here. ■

### Instrument lighting

The brightness of the instrument lighting, displays and centre console lighting can be varied as required.





Fig. 86 Instrument panel lighting

- Press the  button to increase the brightness.
- Press the  button to reduce the brightness.

#### With the ignition switched on

The lighting of the digital displays will adjust automatically, depending on the ambient light.

#### With the vehicle's lights switched on

When the vehicle's lights are switched on, the brightness of the instrument lighting, displays and centre console lighting can be varied by pressing the  and  buttons.

### Headlight range control

When the dipped beam headlights are switched on, the range of the headlights can be adjusted to suit the load of the vehicle.

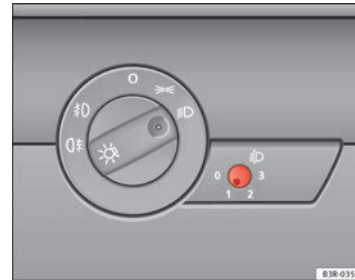



















Fig. 87 Headlight range control

- Briefly press the knob                  to release it from its set position.
- Turn the knob to the required setting.
- Press the knob in again to prevent the setting from being changed unintentionally.

#### Settings

The settings roughly correspond to the following load conditions:

- ① Two front occupants, luggage compartment empty
- ② All seats occupied, luggage compartment empty

- ② All seats occupied, luggage compartment loaded
- ③ Driver only, luggage compartment loaded

### ! CAUTION

Always adjust the headlights to avoid dazzling oncoming traffic. Make sure you lower the headlights when the vehicle is more heavily laden. ■

### Dynamic headlight range control

On vehicles with xenon lamps, the headlights automatically adapt to suit the load being carried when the ignition is switched on and when the vehicle is moving, depending on the load of the vehicle and the type of driving (e.g. when accelerating and braking). ■

### Daytime running lights\*

*The daytime running lights turn on automatically when the ignition is switched on.*

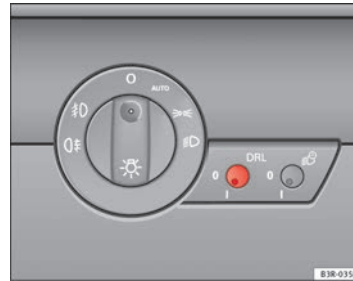

Fig. 88 Daytime running lights switch

#### Activating the function

- Briefly press the knob => Fig. 88 to release it from its set position.
- Turn the knob to position **1**.
- Press the knob in again to prevent the setting from being changed unintentionally.

#### Deactivating the function

- Briefly press the knob => Fig. 88 to release it from its set position.
- Turn the knob to position **0**. ▶

- Press the knob in again to prevent the setting from being changed unintentionally.

This button activates or deactivates the daytime running lights function. With the function activated, when the ignition is switched on the daytime running lights are turned on automatically.



#### Note

Please observe any relevant legal requirements which may apply in your country.

### Adaptive headlights\* (for driving around bends)

When driving around bends, the headlights will light the most important areas of the road.

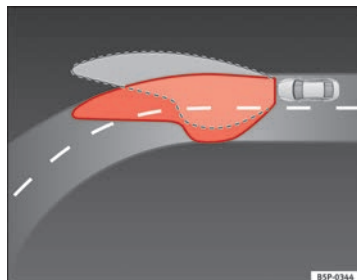

Fig. 89 Adaptive headlights when driving

The dynamic cornering light gives better illumination of the curve area and the side of the road when driving around a bend ⇒ Fig. 89. The dynamic cor-

nering light is controlled automatically depending on the speed and the steering wheel angle.

The dipped beam headlights are regulated automatically when you drive around a bend, depending on how far you turn the steering wheel. The two main headlights move at different angles to avoid that the front of the vehicle is left completely in the dark.



#### Note

The system operates from a speed of about 10 km/h.

### Hazard warning lights

The hazard warning lights are used to draw the attention of other road users to your vehicle in emergencies.



Fig. 90 Centre console: Switch for hazard warning lights

- Press the switch  ⇒ Fig. 90 to switch the hazard warning lights on or off.

All four turn signals flash simultaneously when the hazard warning lights are switched on. The turn signal indicators  $\leftarrow \rightarrow$  and the hazard warning light indicator  $\triangle$  flash at the same time. The hazard warning lights also work when the ignition is switched off.

In an accident in which the airbags are triggered, the hazard warning lights are switched on automatically.



### Note

You should switch on the hazard warning lights to warn other road users, e.g.

- When reaching the tail end of a traffic jam
- If your vehicle breaks down or there is an emergency
- If your vehicle is being towed away or if you are towing another vehicle ■

### Turn signal $\leftarrow \rightarrow$ and main beam headlight lever $\equiv$

*The turn signal and main beam headlight lever also operates the parking lights and the headlight flasher.*

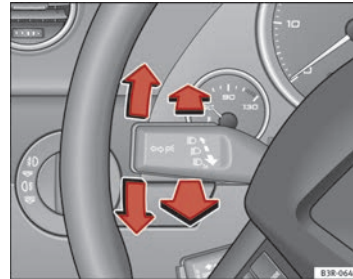

Fig. 91 Turn signal and main beam headlight lever

The turn signal and main beam headlight lever has the following functions:

#### Turn signals $\leftarrow \rightarrow$

- Move the lever all the way up to indicate right or all the way down to indicate left  $\Rightarrow$  Fig. 91.
- Move the lever up or down just as far as the point of resistance and hold it there: the turn signals flash for as long as you hold the lever (for instance when changing a lane).
- Move the lever briefly up or down as far as the point of resistance and release it to signal *briefly* (the turn signals flash three times). ▶

**Main beam headlights** 

- Press the lever forward to switch on the main beams.
- Pull the lever back towards you to switch the main beam headlights off again.





**Headlight flasher** 

- Pull the lever towards the steering wheel to operate the flasher.

**Parking light** 

- Switch the ignition off.
- Move the lever up or down to turn on the right or left-hand parking lights respectively.

**Notes on these functions**

- The *turn signals* only work when the ignition is switched on. The turn signal lamp  or  flashes in the instrument panel when the turns signals  $\Rightarrow$  page 67 are working.
- The turn signals are cancelled automatically when the steering wheel is returned to the straight-ahead position.
- The *main beam headlights* can only be switched on if the dipped beam headlights are already on. The main beam headlight indicator lamp  then comes on in the instrument panel.
- The *headlight flasher* comes on for as long as you pull the lever, even if no other lights are switched on. The main beam headlight indicator lamp  then comes on in the instrument panel.
- When the *parking lights* are switched on, the headlight and the tail light on one side of the vehicle light up with reduced intensity. The parking lights will only work with the ignition off.

**CAUTION**

Never use the main beam headlights or the headlight flasher if this would dazzle oncoming traffic. ■

## Interior lights

### Front interior lights and glove compartment light

*The front interior light also incorporates the reading lights for the driver and passenger.*

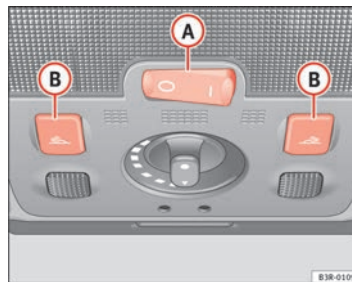



Fig. 92 Detail of headlight: front interior lights

The rocker switch   $\Rightarrow$  Fig. 92 for the front interior light has the following functions:

**Door light position**

- Move switch  to the centre position. ▶

**Interior light switched on**

- Move switch **(A)** to position I.

**Interior light switched off**

- Move switch **(A)** to position O.

**Front reading lights** 

- Press one of the switches **(B)** to turn the left and right reading lights on and off.

**Glove compartment light**

- Open the glove compartment on the front passenger side. The glove compartment light will come on automatically if the side lights or headlights are switched on, and will go out again when the glove compartment is closed.

**Footwell\* and door lighting**

- This is switched on when the doors are opened and off when they are closed.

If the switch is in the courtesy light position, the interior light comes on automatically when the vehicle is unlocked or the doors are opened. The light also comes on when the key is pulled out of the ignition. The light turns off about 30 seconds after closing the doors. The interior light is switched off immediately when the vehicle is locked or when the ignition is switched on.

If a door is left open, the light is switched off after about 10 minutes to prevent the battery from running flat.

The brightness of the lights is automatically adjusted by a dimmer when they are switched on. ■

**Ambient lighting\***

*The ambient lighting illuminates a number of important controls.*



**Fig. 93** Detail of headliner: ambient lighting

The lights in the door handles come on automatically when the ignition is switched on.

The lighting above the windscreen\* also comes on when the side lights or headlights are switched on. The centre console is illuminated from above.

The background lighting cannot be switched off manually. ■

## Rear reading lights

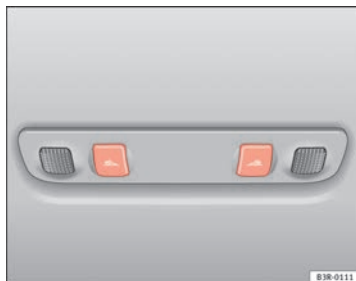



Fig. 94 Detail of headliner: rear reading lights

The reading lights are switched on and off with the switches .

## Luggage compartment light



Fig. 95 Detailed view of the top of the luggage compartment: luggage compartment lighting

- The light is in the upper part of the luggage compartment.

The light  $\Rightarrow$  Fig. 95 switches on automatically when the rear lid is opened. The luggage compartment light is switched off automatically if the rear lid is left open for more than 10 minutes. ■

## Visibility

### Heated rear window

*The rear window heating clears the rear window of condensation.*



Fig. 96 Switch for heated rear window

- Press button  to switch the rear window heating on or off  
⇒ Fig. 96.

The heated rear window only works when the ignition is switched on. An indicator lamp on the button lights up when the rear window heater is switched on.

The heated rear window switches off automatically after about 10 minutes if the outside temperature is above 0°C.

Depending on the outside temperature, the exterior mirrors are also heated while the heated rear window is turned on.

The exterior mirror heating is not activated at temperatures above approximately 20°C.



### For the sake of the environment

Switch off the heated rear window as soon as the rear window has demisted. By saving electrical power you can also save fuel. ■

### Sun visors

*The sun visors can improve visibility and contribute to safety.*

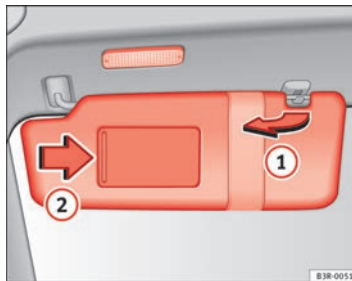

Fig. 97 Sun visor

The sun visors ① for the driver and the front passenger can be pulled out of their mountings in the centre of the vehicle and turned towards the doors ⇒ Fig. 97.

The vanity mirrors in the sun visor have covers. On opening the cover ②, the mirror light\* located in the headliner is automatically switched on. The ►

light switches itself off when the cover is closed and when the sun visor is pushed back up.

### Sun blind\*

The rear side windows are fitted with sun blinds.

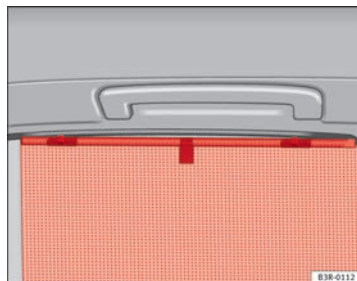

Fig. 98 Sun blind extended to cover rear side window

#### Sun blind (rear side windows)

- Pull out the blind and hook it into the hooks at the top of the door frame ⇒ Fig. 98.

## Windscreen wipers

### Windscreen wipers

The windscreen wiper lever controls the windscreen wipers and the automatic wash and wipe.

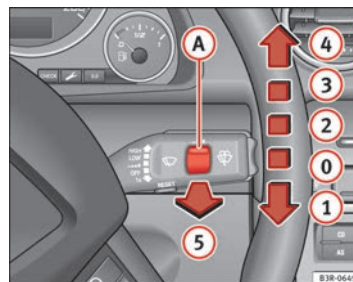

Fig. 99 Windscreen wiper lever

The windscreen wiper lever ⇒ Fig. 99 has the following settings:

#### Short wipe

- Move the lever down to position ① to give the windscreen a short wipe.

#### Intermittent wipe / Rain sensor\* (activate)

- Move the lever up to position ②.
- Move the switch A up or down to set the wiper intervals. ▶

- In vehicles equipped with a rain sensor\*, you can move the switch **(A)** up and down to set the sensitivity of the rain sensor.

#### Slow wipe

- Move the lever up to position **(3)**.

#### Continuous wipe

- Move the lever up to position **(4)**.

#### Automatic wash and wipe

- Pull the lever towards the steering wheel, **(5)**, to activate the windscreen washer.
- Release the lever. The washer will stop and the wipers will keep running for approximately 4 seconds.

#### Deactivating the windscreen wiper

- Pull the lever to basic position **(0)**.

#### General notes

The washers and wipers will work only when the ignition is switched on.

If you stop briefly, e.g. at traffic lights, the wiper speed will automatically be reduced. The rain sensor\* will automatically be set to the intermittent wipe function.

The windscreen washer jets are heated when the ignition is switched on.

The wiper intervals in the intermittent wipe setting are also varied automatically according to the road speed (in addition to the manual delay setting).

When the lights are switched on you should only pull the lever briefly to wash the windscreen, otherwise the headlight washers\* will also be enabled. This will use an unnecessary amount of fluid from the reservoir.

#### Rain sensor

The rain sensor\* will only function in the intermittent wipe position. The intermittent wipe function is enabled automatically when it starts to rain.

If the windscreen wiper lever was in the intermittent wipe position when the ignition was off, the rain sensor will not activate until you reach a speed of 6 km/h.

Use switch **(A)** to set the sensitivity of the rain sensor\*.

If you have selected a high sensitivity level for the rain sensor the windscreen wipers will react sooner to any moisture on the windscreen.

The wiper intervals in the intermittent wipe setting are also varied automatically according to the road speed (in addition to the sensitivity setting).



#### WARNING

- For correct visibility and safe driving, the wiper must be in perfect condition ⇒ page 220. Failure to do so could result in an accident.
- The rain sensor\* is only intended to assist the driver. The driver is still obliged to manually operate the windscreen wipers as required depending on visibility.
- Do not use water-repellent coatings on the windscreen. In bad visibility conditions such as light rain, low sun or when driving at night, these coatings can cause increased dazzle, which is a serious safety hazard. Such coatings can also cause the wiper blades to make noise.



#### CAUTION

- In the event of frost, check that the wiper blade has not frozen before activating the windscreen wipers. Should the windscreen wiper system be enabled when the blade is frozen, this could damage it or even the windscreen wiper system motor.
- Make sure you switch off the windscreen wiper system (lever in position 0) before you use an automatic car wash. This will avoid inadvertent triggering of the wipers and possible damage to the wiper system. ▶

**Note**

- Check that the washer fluid reservoir is full before starting a long journey. Fill the reservoir ⇒ page 241.
- Worn or dirty wiper blades can cause smearing on the glass which can also impair the effectiveness of the rain sensor\*. Check the condition of windscreen wiper blades at regular intervals.

**Rear window wiper**

The windscreen wiper lever also operates the rear window wiper and the automatic wash and wipe.



**Fig. 100 Windscreen wiper lever**

The rear window wiper and the automatic wash/wipe system are switched on as follows:

**Intermittent wipe**

- Push the windscreen wiper lever forwards until it clicks into the first position ⇒ Fig. 100 ①. The rear window wiper will wipe the window approximately every 4 seconds.

**Automatic wash/wipe**

- Push the lever forwards to position ②. The rear window wiper will work for the time you hold the lever in this position.
- Release the lever. The rear window wiper will keep working for approximately 4 seconds.

**Deactivating the interval wipe function**

- Pull the lever backwards until it returns to its original position.

The rear window wiper will start working automatically if reverse gear is engaged while the windscreen wipers are switched on.

**WARNING**

For correct visibility and safe driving, the wiper must be in perfect condition ⇒ page 220. Failure to do so could result in an accident.

**CAUTION**

In icy conditions, always check that the wiper blades are not frozen to the glass before using the windscreen wipers/rear window wiper. The windscreen wiper blades and even the windscreen wiper motor could be damaged if you start the windscreen wipers/rear window wiper with the blades frozen to the glass.

## Headlight washer system



Fig. 101 Headlight with extended washer jet

With the lights switched on, operate the automatic wash and wipe ⇒ Fig. 99 ⑤, and keep the lever pulled towards you for at least 1 second.

The headlight washer jets come out of the bumper automatically (under water pressure) ⇒ Fig. 101.

Clean off dirt (insects, etc.) from the lenses at regular intervals, for instance when filling the tank.

To ensure that the system works properly in winter, keep the nozzle holders free of snow and remove any ice with a de-icer spray. ■

## Rear view mirrors

### Interior mirror with manual anti-dazzle setting

#### Normal setting

- Point the lever at the bottom of the mirror forwards.

#### Anti-dazzle setting for the interior mirror

- Point the lever at the bottom of the mirror to the rear. ■

### Interior mirror with automatic anti-dazzle adjustment\*

*The automatic anti-dazzle function can be switched on and off as desired.*

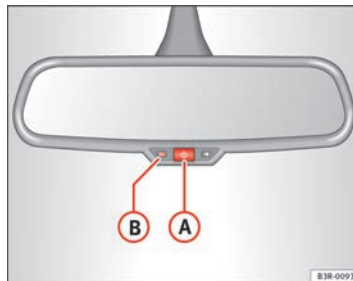

Fig. 102 Interior mirror with anti-dazzle setting: Indicator lamp and on/off switch ▶

### Switching off the anti-dazzle function

- Press button **A** ⇒ Fig. 102. Indicator lamp **B** goes off.

### Switching on the anti-dazzle function

- Press button **A** ⇒ Fig. 102. Indicator lamp **B** turns on.

### Anti-dazzle function

The anti-dazzle function is activated every time the ignition is switched on. The green indicator lamp lights up in the mirror housing.

When the anti-dazzle function is enabled, the interior mirror will darken *automatically* according to the amount of light it receives. The anti-dazzle function is **disabled** if:

- the interior lighting is switched on
- reverse gear is engaged

### Sensors for automatic headlights\*

When the light switch is set to the **AUTO** position, the dipped beam headlights are switched on and off automatically according to the ambient light level with the aid of the sensors located in the interior mirror ⇒ page 118.

#### WARNING

Electrolyte fluid can leak from a broken mirror. This fluid can cause irritation to the skin, eyes and respiratory organs. Wash thoroughly with clean water should you come into contact with this fluid. Seek medical assistance if needed!

#### CAUTION

Electrolyte fluid leaking from a broken mirror can cause damage to plastic surfaces. Use a sponge or similar to remove the fluid as soon as possible.

#### Note

- The interior mirror automatic anti-dazzle function\* will only work properly if the sun blind\* for the rear window is retracted and if there are no other objects preventing light from reaching the mirror.
- If you have to stick any type of sticker on the windscreen, do not do so in front of the sensors. Doing so could prevent the automatic headlight or anti-dazzle function from working correctly or even from working at all. ■

### Exterior mirrors

The exterior mirrors are adjusted electrically.

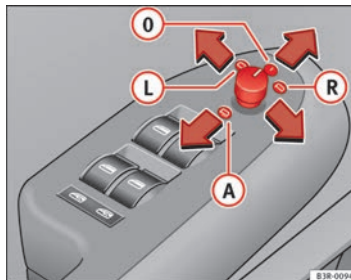

Fig. 103 Detailed view of the armrest: Adjuster knob

### Adjusting the exterior mirrors

- Turn the adjuster knob to position ⇒ Fig. 103 **L** (left exterior mirror) or position **R** (right exterior mirror).
- Move the knob as required to adjust the exterior mirror for a good view behind you. ▶

### Retracting both exterior mirrors

- Turn the knob to position **(A)**.

It is advisable to fold the exterior mirrors, for example when parking or when driving through narrow spaces.

### Heated mirrors

The mirrors are heated (depending on the outside temperature) when the heated rear window → page 128 is switched on.

The exterior mirror heating is not activated at temperatures above approximately 20°C.

### Memory for exterior mirrors\*

In vehicles with memory function for the driver seat, the setting of the exterior mirrors is automatically stored together with the seat position → page 139.

### Tilting function for exterior mirror on the passenger side\* (only if equipped with memory for exterior mirrors)

When reverse gear is engaged, the mirror surface tilts slightly downwards, provided the mirror control is switched to the exterior mirror on the passenger side (knob in position **(R)** ⇒ Fig. 103). This provides a better view of the kerb when parking.

The mirror returns to its original position as soon as reverse gear is disengaged and the vehicle is driven forwards at a speed above 15 km/h, or when the mirror control is turned to position **(L)** or to the neutral position **(0)**.



### CAUTION

- Rear view convex or aspheric\* mirrors increase the field of vision, although objects appear smaller and further away in the mirrors. Therefore, you should not rely on these mirrors for judging the distance of vehicles behind.
- If one of the mirror housings is knocked out of position (e.g. when parking), the mirrors must first be fully retracted with the electric control. Do not readjust the mirror housing by hand, as this will interfere with the mirror adjuster function.



### Note

If the electrical adjustment ever fails to operate, the mirrors can be adjusted by hand by lightly pressing the edge of the mirror glass. ■

## Seats and storage compartments

### Manual adjustment of the front seats

#### Seat adjuster controls

*There are several seat adjustment functions for your convenience*

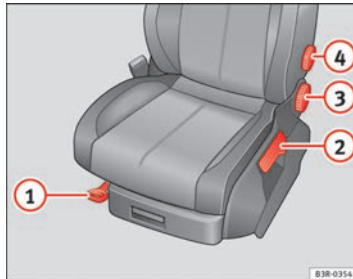

Fig. 104 Adjuster controls on driver seat

Some of the equipment listed is only fitted on certain models or is an optional extra.

#### Controls

- ① Moving the seat backwards or forwards
- ② Raising/lowering the seat
- ③ Adjusting the backrest angle
- ④ Adjusting the lumbar support

#### Moving the seats forwards and backwards

- Lift the lever ① ⇒ Fig. 104 and move the seat to the desired position.
- Then release the lever ① and move the seat further until the catch engages.

#### **⚠ WARNING**

The driver seat must only be moved forwards and backwards when the vehicle is at a standstill. Failure to do so could result in an accident.

#### Adjusting the seat height\*

##### Raising the seat

- Pull the lever ② ⇒ Fig. 104 up repeatedly until the seat is in the desired position.

##### Lowering the seat

- Press the lever ② down repeatedly until the seat is in the desired position. ▶

**WARNING**

- The height of the driver seat must not be adjusted while driving. Failure to do so could result in an accident.
- Be careful when adjusting the seat height. Injuries can be caused if the seat height is adjusted without due care and attention.

### Adjusting the backrest angle

---

- Lean forwards to take your weight off the backrest.
- Turn the adjuster wheel ③ ⇒ Fig. 104 to set the angle of the backrest as required.

**WARNING**

The front backrests must not be reclined for driving. Otherwise, seat belts and the airbag system might not protect as they should, with the subsequent danger of injury.

### Adjusting lumbar support\*

---

- Do not exert any pressure on the backrest and turn adjuster wheel ④ ⇒ Fig. 104 to adjust lumbar support.

As you make the adjustments, the curvature of the cushioned area of the lumbar region becomes more or less acute. In this way, it adapts to the natural curvature of the spine.

## Electric adjustment of front seats\*

### Adjusting the seat

The arrangement of the switches corresponds with the design of the seats.

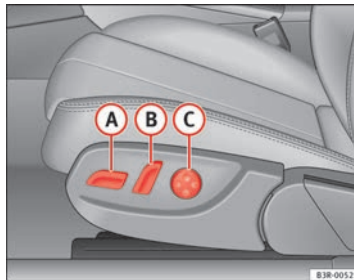

Fig. 105 Front seat: Adjuster controls

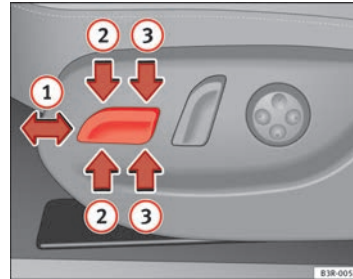

Fig. 106 Front seat: Seat adjustment switches

The adjustment switches for the seat and backrest correspond with the layout, design and operation of the seat. The seats can be adjusted merely by pressing the corresponding switch in the required direction.

### Moving the seat forwards / backwards

- Press switch **A** ⇒ Fig. 105 forwards or backwards **1** ⇒ Fig. 106 ⇒ **Δ**.

### Raising/lowering the seat

- Press switch **A** up or down ⇒ **Δ**.

### Raising/lowering the front part of the seat

- Press the front of switch **A** up or down **2** ⇒ **Δ**.

### Raising/lowering the rear part of the seat

- Press the rear of switch **A** up or down **3** ⇒ **Δ**.



**Controls**

- A** Seat adjustment
- B** Backrest adjustment
- C** Lumbar support\*

**! WARNING**

- The electrical seat adjustment also works when the ignition is off or when the key is not in the ignition. To avoid accidental injuries, never leave children unattended in the vehicle.
- For safety reasons, the seat must only be adjusted when the vehicle is at a standstill. Failure to do so could result in an accident.
- Be careful when adjusting the seat height. Injuries can be caused if the seat height is adjusted without due care and attention.

**Adjusting the backrest angle**

**Fig. 107** Front seat:  
Backrest adjuster switch

- Press the button in the appropriate direction of the arrow ⇒ **Fig. 107** to adjust the backrest ⇒ **!**.

**! WARNING**

The front backrests must not be reclined for driving. Otherwise, seat belts and the airbag system might not protect as they should, with the subsequent danger of injury.

**Lumbar support\***

*The lumbar support can be adjusted to fit the natural curve of the spine.*



**Fig. 108** Front seat:  
Adjuster switch for lumbar support

**Adjusting the contour**

- Press the front part of the adjuster switch ⇒ **Fig. 108** to increase the contour of the lumbar support. ▶

- Press the rear part of the adjuster switch to decrease the contour of the lumbar support.

#### Adjusting the height

- Press the top part of the adjuster switch to move the contour upwards.
- Press the bottom part of the adjuster switch to move the contour down.

The lumbar support provides effective support for the natural curvature of the spine to give a more relaxed seating position, especially on long journeys.

## Driver seat memory\*

### Description

*The memory buttons in the driver door can be used to store and recall up to four different positions for the driver seat and exterior mirrors.*

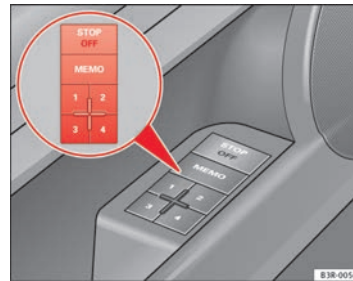

**Fig. 109 Driver door: Memory system**

### Memory buttons

Using memory buttons 1, 2, 3 and 4 ⇒ Fig. 109, you can store and recall the seat and exterior mirror positions for up to four different drivers.

#### **STOP** button

The seat memory will be disabled if the **STOP** button is in the up position (press and release). The word **OFF** will light up next to the **STOP** button (only visible when the lights are switched on).

The stored settings will all remain in the memory. However, the seat and the exterior mirrors can now only be adjusted using the conventional electrical adjustment. Use of the **STOP** button is recommended to disable the memory ▶

system when the vehicle is being driven *temporarily* by a different driver whose settings do not need to be stored in the memory.



#### Note

You can also use the remote control to call up the stored settings ⇒ page 141.

### Storing settings

The **STOP** button must be in its down position (pressed in) before you can store the desired settings.

- Adjust the driver seat as required ⇒ page 137.
- Adjust both exterior mirrors ⇒ page 133.
- Press and hold the **MEMO** button. At the same time, press one of the memory buttons for at least a second.
- Release both buttons. The setting is now stored on the selected memory button.

Any new setting selected automatically cancels the existing setting stored on the memory button. It is best to begin with memory button No. 1 for the first driver and then assign the other memory buttons to each subsequent driver.

The seat and mirror positions are stored when the vehicle is **locked** with the remote control and are assigned to the remote control key. The exterior mirrors adjust automatically to the previous position when you **unlock** the vehicle; the driver seat adjusts automatically when you open the driver door.

However, this does not delete the settings stored in memory buttons 1 to 4. These settings can be enabled at any time. ■

### Activating settings

*Stored settings can be recalled using either the memory buttons or the remote control (remote control key).*

#### Using the memory buttons

- If the driver door is open, press the desired memory button briefly.
- If the driver door is closed, press and hold down the appropriate memory button until the seat and exterior mirrors reach their programmed positions.

#### Using the remote control

- Unlock the vehicle using the remote control and open the driver door within the next ten minutes.

The seat adjustment will have to be called up using the memory buttons if the driver door is not opened within 10 minutes after unlocking the vehicle with the remote control.



#### WARNING

- For safety reasons, the seat must only be adjusted when the vehicle is at a standstill. Failure to do so could result in an accident.
- In an emergency, the memory function can be stopped at any time by pressing the **STOP** button or by briefly pressing any of the memory buttons. ■

## Assigning remote control keys

*The key must be assigned to a memory button so that the positions stored in the memory can also be recalled using the remote control key.*

### Assigning the remote control key to a memory button

- Using the memory button, recall the settings that are to be programmed onto the key.
- Keeping the memory button pressed down, press the unlock button on the remote control key within 10 seconds.
- Wait for about 2 seconds before releasing the memory button.

### Deleting assignment of the remote control key to the memory button

- Press and hold the **[MEMO]** button and press the unlock button on the remote control key within 10 seconds.
- Wait for about 2 seconds before releasing the **[MEMO]** button.

The previous settings are automatically cancelled when the keys are re-assigned to different memory buttons.

## Head restraints

### Front head restraints

*In combination with properly worn seat belts, the head restraints offer effective protection, provided they are properly adjusted to suit the height of the occupant.*

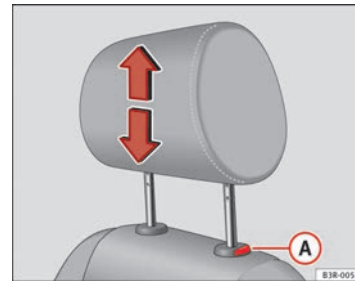

Fig. 110 Front seats:  
Head restraints

### Raising the head restraint

- Take hold of the sides of the head restraint with both hands.
- Pull up the head restraint.

### Lowering the head restraint

- Press button **A** and lower the head restraint.

### Removing the head restraints

- Pull the head restraint up as far as it will go. ▶

- Press button **(A)** and pull out the head restraint.

#### Fitting the head restraint

- Insert the head restraint in its guides until it clicks into place. Press button **(A)** and lower the head restraint.

The height of the head restraints is adjustable. They should be set to suit the height of the occupant. In combination with the seat belts, the head restraints offer effective protection, provided they are properly adjusted.

For best protection, the top of the head restraint should be at least at eye level or higher.

#### Head restraints on the side rear seats

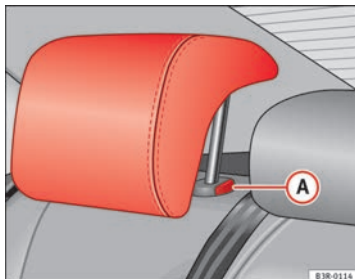

Fig. 111 Outer rear seats: Head restraints

#### Raising the head restraint

- Take hold of the sides of the head restraint with both hands.
- Pull the head restraint up as far as it will go.

#### Lowering the head restraint

- Press button **(A)** ⇒ Fig. 111 and lower the head restraint.

#### Removing the head restraint

- Pull the head restraint up as far as it will go.
- Press button **(A)** ⇒ Fig. 111 and pull out the head restraint.

#### Fitting the head restraint

- Insert the head restraint in its guides until it clicks into place. Press button **(A)** and lower the head restraint.

When the rear seats are not occupied, the head restraints should be moved to the lowest position so that they do not obstruct the driver's field of vision.

#### Rear seat central head restraint

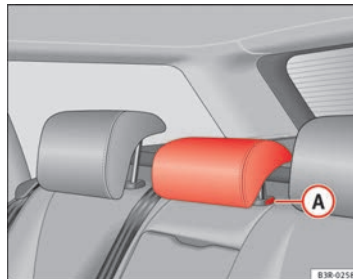

Fig. 112 Centre rear seat: Head restraints

### Raising the head restraint

- Take hold of the sides of the head restraint with both hands.
- Pull the head restraint up as far as it will go.

### Lowering the head restraint

- Press button **(A)** ⇒ Fig. 112 and lower the head restraint.

### Removing the head restraint

- Pull the head restraint up as far as it will go.
- Press button **(A)** ⇒ Fig. 112 and pull out the head restraint.

### Fitting the head restraint

- Insert the head restraint in its guides until it clicks into place.  
Press button **(A)** and lower the head restraint.

When the rear seats are not occupied the head restraints should be moved to the lowest position so that they do not obstruct the driver's field of vision.

## Armrests

*The armrest can be adjusted to several positions and incorporates a storage compartment.*

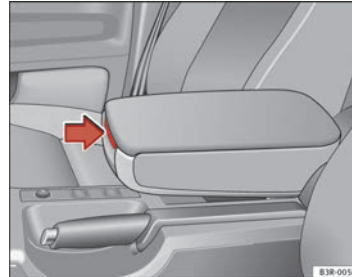

Fig. 113 Armrest between the driver seat and front passenger seat

### ■ Adjusting the armrest

- To adjust the position of the armrest, fold the armrest all the way down.
- Then lift the armrest gradually until it engages in the desired position.

### Opening the storage compartment

- Press the release lever ⇒ Fig. 113.

Please note that the armrest can restrict the driver's movements when it is lowered. The armrest should therefore be raised when driving in city traffic. ■

## Luggage compartment

### Loading the luggage compartment

*Loads in the luggage compartment should be safely secured.*

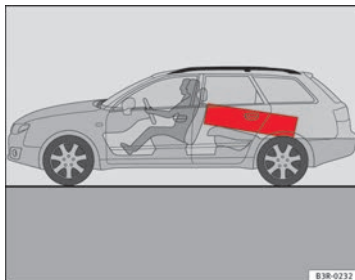

**Fig. 114** Position heavy items as far forward as possible.

To maintain safe handling on the road, please observe the following points:

- Distribute the load evenly.
- Position heavy items as far forward as possible ⇒ Fig. 114.
- Secure the load with a luggage net\* or with non-elastic straps secured to the fastening rings ⇒ page 145.



#### WARNING

- Unsecured objects in the luggage compartment can suddenly shift and cause changes in the handling of the vehicle.
- In an accident or a sudden manoeuvre, loose objects in the passenger compartment can be flung forward and might injure vehicle occupants.
- Always keep all objects in the luggage compartment and use appropriate grips to secure them, particularly in the case of heavy objects.
- When you transport heavy objects, always bear in mind that a change of the centre of gravity can also cause changes in vehicle handling.
- Please refer to the notes on ⇒ page 7.



#### CAUTION

Make sure that no hard objects chafe against the wires of the heating element in the rear window and damage them.



#### Note

The tyre pressure must be adjusted according to the load. If necessary, consult the tyre pressure label on the door pillar ⇒ page 249. ■

### Fastening rings

There are four fastening rings in the luggage compartment, which can be used to secure loads.

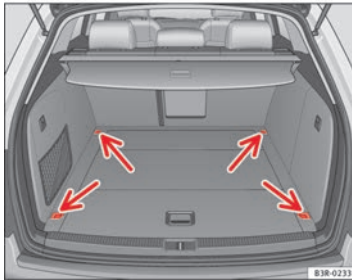

Fig. 115 Location of fastening rings in luggage compartment

- Use the fastening rings to secure the load ⇒ Fig. 115 -arrows-.
- Please refer to the safety notes ⇒ page 17.

### Luggage net\*

The luggage net can be used to secure and retain light items in the luggage compartment.

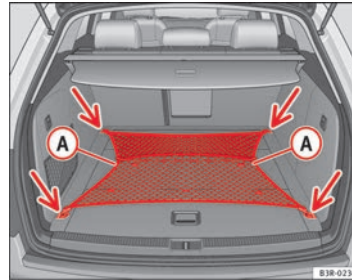

Fig. 116 Stretched luggage net

### Luggage net

- Secure the luggage net to the four fastening rings -arrows- ⇒ Fig. 116.

The luggage net can be attached to the fastening rings in the bottom of the luggage compartment panel.

#### **WARNING**

The luggage net should only be used to hold objects weighing up to 5 kg. Heavier objects cannot be safely secured (risk of injury).

### Retaining strap\*

The retaining strap can be used to secure items of luggage to the right-hand side lining in the luggage compartment.

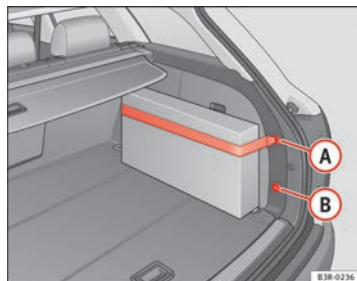

Fig. 117 Retaining strap attached to right-hand side lining

- Hook the retaining strap into housing (A) or (B) ⇒ Fig. 117.

You can attach the strap to the top or bottom housing, depending on the size of the object you wish to secure.

To secure shorter objects, the retaining strap can also be attached to the centre. However, this is only possible if the strap is attached to housing (B).

#### WARNING

The retaining strap should only be used to hold objects weighing up to 5 kg. Heavier objects cannot be safely secured (risk of injury).

### Luggage compartment cover\*

The cover blocks the view into the luggage compartment.

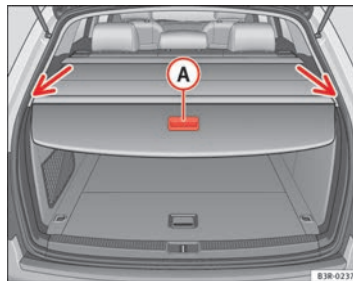

Fig. 118 Rear lid open with luggage compartment cover closed

#### Pulling out the luggage compartment cover

- Using handle (A) ⇒ Fig. 118, pull the rolled-up cover evenly towards the rear of the vehicle.
- Insert the ends of the bar into the grooves in the left and right-hand side trim ⇒ Fig. 118 (arrows).

#### Retracting the luggage compartment cover

- Lift the bar out of the grooves in the side trim.
- Let the cover roll up slowly.

Removing and installing the luggage compartment cover ⇒ page 148

**! WARNING**

The luggage compartment cover should not be used as a storage shelf. Articles placed on this cover could cause injury to vehicle occupants in an accident or if the brakes are applied suddenly.

### Net partition\*

The net partition prevents loose objects in the luggage compartment from being thrown forward into the passenger compartment (e.g. under sudden braking).

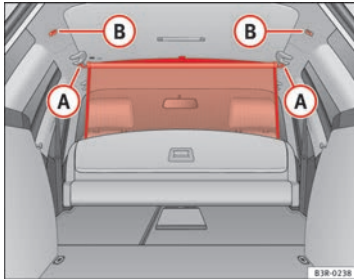

Fig. 119 Retainers for the net partition

#### Pulling out and securing the net partition

- Pull the net up as far as it will go.
- Engage the ends of the bar in the retainers **(B)** ⇒ Fig. 119.

#### Using the net partition with the rear backrest folded down

- Fold down the rear backrests ⇒ page 150.
- Pull the net upwards.
- Engage the ends of the bar in the retainers **(A)** ⇒ Fig. 119.

#### Retracting the net partition

- Unhook the bar from the retainers.
- Let the net retract slowly.

Removing and installing the net partition ⇒ page 148.

### Removing and installing luggage compartment cover / net partition

*The luggage compartment cover / net partition can only be removed when the rear backrests are folded forwards.*

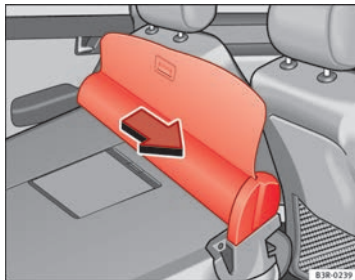

Fig. 120 Removing luggage compartment cover / net partition

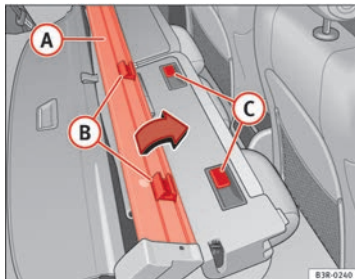

Fig. 121 Installing luggage compartment cover / net partition

#### Removing luggage compartment cover / net partition

- Open the right-hand rear door.
- Fold down the backrests ⇒ page 150.
- Pull the net partition in the direction indicated ⇒ Fig. 120 and lift it out of the retaining rails.

#### Installing luggage compartment cover / net partition

- Open the right-hand rear door.
- Fold down the backrests ⇒ page 150.
- Fit the net partition **A** on the backrest so that the retainers **B** are located next to the retaining rails **C** ⇒ Fig. 121.
- Push the luggage compartment cover / net partition towards the left-hand side of the vehicle as far as it will go. ■

### Luggage compartment liner\*

You can use the liner to protect the inside of the luggage compartment when carrying wet or dirty items.

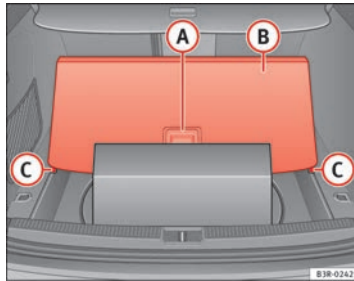

Fig. 122 Floor panel raised

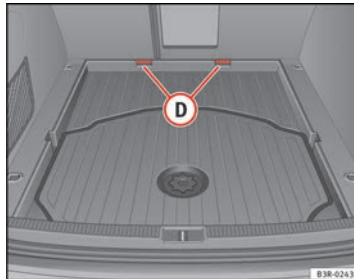

Fig. 123 Floor panel removed for increased luggage space

### Lifting the floor panel

- Open the rear lid.
- Take hold of handle (A) ⇒ Fig. 122, lift the floor panel (B) and line up the bottom corners of the floor panel with the recesses (C).
- Put the items you are transporting onto the luggage compartment liner

### Folding the floor panel

- Open the rear lid.
- Take hold of the handle (A) ⇒ Fig. 122 and fold out the floor panel as far as the rear backrest.

### Removing the floor panel

- Open the rear lid.
- Take hold of the handle (A) ⇒ Fig. 122 and fold out the floor panel as far as the rear backrest.
- Pull the complete floor panel towards the rear of the vehicle so it comes out of the retainers (D) ⇒ Fig. 123.

Small items can also be stored **under** floor panel (B) ⇒ Fig. 122.

The space available for carrying items in the luggage compartment liner can be increased by folding out the floor panel or removing it completely.

### ! CAUTION

When the luggage compartment floor panel is folded out to the upright position you should not transport items weighing more than 7.5 kg, or items which exceed 2/3 of the height of the upright floor panel. ▶

**Note**

It is advisable to secure the items by means of a strap secured to the fastening rings on the left and the right hand side.

### Side storage compartment

The CD-ROM player for the navigation system\* is located in the left side compartment of the luggage compartment.



**Fig. 124** Luggage compartment: Side trim with closed storage compartment

- To open the storage compartment, pull the handle forwards ⇒ Fig. 124.

#### CD-ROM player for navigation system\*

The CD-ROM player for the navigation system is located in this storage compartment in the luggage compartment. Separate operating instructions are enclosed for this system.

### Extending the luggage compartment

The two sections of the backrest can be folded forwards either together or separately to increase the capacity of the luggage compartment.

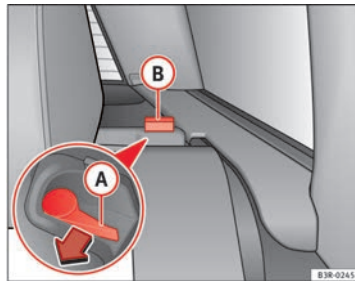

**Fig. 125** Backrest release lever

#### Folding the backrest forwards

- Press the release lever **A** ⇒ Fig. 125 in the direction indicated by the arrow.
- Fold down the backrest.

#### Returning the backrest to its upright position

- Push the backrest up until it engages securely ⇒ **Δ**. The red marking on the tab **B** should no longer be visible when the backrest is properly secured. ▶

**WARNING**

- Make sure that the rear backrest is securely locked in position so that the seat belt can provide proper protection on the centre rear seat.
- The rear backrest must always be securely latched so that objects stored in the luggage compartment will not fly forward during sudden braking.

**CAUTION**

When returning the backrest to an upright position, make sure that the seat belts for the outer rear seats are in their guides, so that they cannot be caught up and damaged in the catches for the backrest.

### Ski bag\*

You can use the ski bag to transport skis or other extra-long objects safely inside the vehicle without soiling or damaging the upholstery.

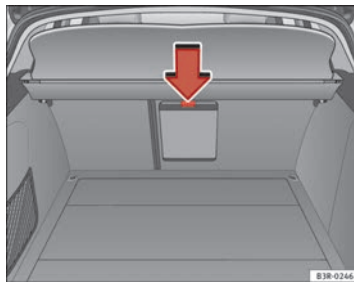

Fig. 126 Detailed view of the rear of the rear backrest: Ski bag cover

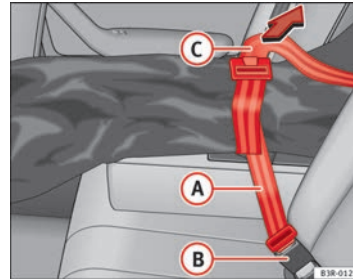

Fig. 127 Fastening the ski bag in the seatbelt buckle

### Loading

- Open the rear lid.
- Press the release catch for the ski bag cover (flecha) and fold the cover downwards ⇒ Fig. 126.
- Pull down the centre rear armrest.
- From the passenger compartment, press down the release catch for the ski bag cover and pull out the cover.
- Pull out and unfold the ski bag.
- The long items can now be loaded through the luggage compartment into the ski bag ⇒ ⚠.

### Securing

- Insert the fastening belt (A) ⇒ Fig. 127 of the ski bag into the centre seat belt buckle (B).
- Pull the free end of belt (C) to tighten.

### Storing

- Close the cover of the load-through hatch in the luggage compartment.
- Carefully fold away the ski bag.
- Close the inside cover of the load-through hatch from the passenger compartment.

### WARNING

The ski bag must be secured in place with the fastening belt after it has been loaded.



### Note

Do not fold away the ski bag after use if it is still damp.

## Roof rack / roof rails\*

### Description

*Additional luggage can be carried on the roof rack.*

Note the following points if you intend to carry loads on the roof:

- We recommend using the cross bars from the of SEAT Genuine Accessories range.
- These cross bars form the basic elements of a complete roof rack system. For safety reasons, however, the corresponding additional fastenings must be fitted to carry luggage, bicycles, surfboards, skis and boats. All the components of this system are available from a Technical Service.



### CAUTION

Any damage to the vehicle caused by the use of other types of roof rack or incorrect installation will not be covered by the factory warranty. The roof rack system must therefore be installed exactly according to the instructions provided.

### Attachment points

*The roof rack must be attached at the marked points only.*

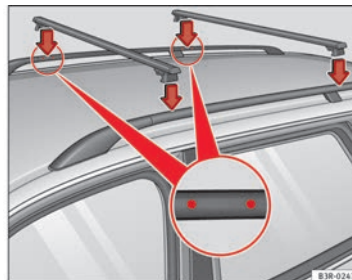

**Fig. 128 Attachment points for cross bars**

The cross-bars must be fitted exactly between the points marked on the roof railings → Fig. 128. The markings are visible on the inside of the railings.



### CAUTION

A roof rack unit must not be used if the vehicle is not equipped with roof rails (basic support).

## Roof load

*Loads carried on the roof must be securely attached. The vehicle's handling is affected whenever you carry loads on the vehicle.*

The authorised load on the roof of your vehicle is **75 kg**. Use the weight of the roof rack system and that of the load as a basis to calculate the roof load.

If less resistant systems are used, the roof rack must not be loaded to the maximum weight permitted. If less resistant systems are used, these must only be loaded to the maximum weight permitted indicated in the assembly instructions.

### WARNING

- Loads carried on the roof must be securely attached. Failure to do so could result in an accident.
- Do not exceed the maximum roof load for the vehicle, the maximum axle loads or the maximum gross vehicle weight. Failure to do so could result in an accident.
- When transporting heavy or bulky loads on the roof, bear in mind that the vehicle's handling is affected by the extra weight on the roof and a possible susceptibility to cross winds. Adjust your speed and driving style accordingly to avoid accidents.

### CAUTION

Please take extra care not to let the rear lid strike the roof load when open.

## For the sake of the environment

Roof racks are often left attached for convenience, even when they are not being used. However, the increased air resistance means that the vehicle uses more fuel. For this reason you should always take off the roof rack when it is not in use.

## Drink holder

### Front drink holder



Fig. 129 Detailed view of the dash panel: Drink holder

- To open the drink holder, press the symbol  on the drink holder lid ⇒ Fig. 129
- To close the drink holder, press it in until it engages. ▶

**! WARNING**

- Do not put any hot drinks in the drink holder while the vehicle is moving. You can be scalded if the hot liquid is spilled.
- Do not use hard china cups or glasses. These could cause injury in the event of an accident.

### Drink holder in the rear armrest\*

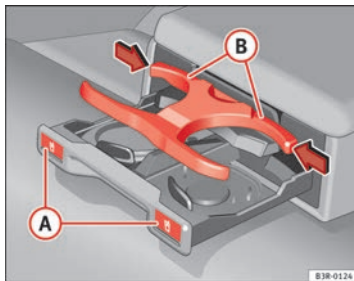

Fig. 130 Drink holder in the rear armrest

#### Opening the drink holder

- Press the symbol **A** ⇒ Fig. 130.

#### Adjusting the retainer arm

- To adjust one of the retainer arms **B**, release it by pressing in the direction indicated (arrow) and move it as required.

The retainer arm should be positioned against the drink holder so that it is held securely.

One or two drink holders can be held in the centre console.

**! WARNING**

- Do not put any hot drinks in the drink holder while the vehicle is moving. You can be scalded if the hot liquid is spilled.
- Do not use hard china cups or glasses. These could cause injury in the event of an accident.

### Ashtray\*, cigarette lighter\* and electric sockets\*

#### Front ashtray\*

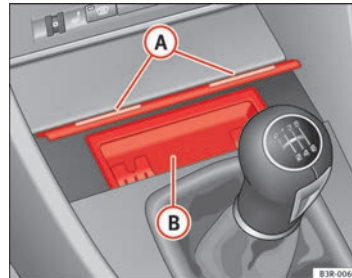

Fig. 131 Centre console: Open ashtray

#### Opening the ashtray

- Lightly press the front part of the ashtray **A** ⇒ Fig. 131. ▶

### Removing the ashtray

- Take hold of the sides of the ashtray **(B)** ⇒ Fig. 131 and lift it out.

### Fitting the ashtray casing

- Insert the casing and press it into its mountings.



#### WARNING

Never put waste paper in the ashtray, as this could cause a fire.

### Removing the ashtray

- Take hold of the lid ⇒ Fig. 132 and lift out the ashtray.

### Fitting the ashtray casing

- Open the lid on the ashtray and press the casing into the mounting as far as it will go.



#### WARNING

Never put waste paper in the ashtray, as this could cause a fire.

## Rear ashtray

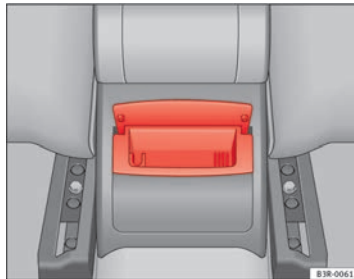

Fig. 132 Rear ashtray

### Opening the ashtray

- Lift the lid.

## Cigarette lighter\*

*The 12 volt socket for the cigarette lighter can also be used as a power source for other electrical appliances.*



Fig. 133 Cigarette lighter in the centre console ▶

**Using the cigarette lighter**

- Press in the cigarette lighter button.
- Wait for the lighter to pop out slightly.
- Pull out the cigarette lighter immediately.
- Use the glowing heater element of the cigarette lighter to light your cigarette.
- Put the cigarette lighter back in its socket.

**Operating the socket**

- Take out the cigarette lighter.
- Insert the plug of the electrical appliance into the cigarette lighter socket.

The cigarette lighter ⇒ Fig. 133 employs a standard 12 volt socket, which can also be used as a power source for electrical appliances. The appliances connected to the socket must not exceed a power rating of 100 W.

**WARNING**

- **Be careful when using the electric cigarette lighter. Carelessness or negligence when using the cigarette lighter can cause burns.**
- **The lighter will only work when the ignition is switched on.**
- **The electrical sockets and, therefore, any appliances connected to them will only work when the ignition is switched on.**

**CAUTION**

Always use the correct type of plugs to avoid damaging the sockets.

**Note**

The use of electrical appliances with the engine switched off will cause a battery discharge. ■

**Electric socket in the luggage compartment\***

*Electrical equipment can be connected to the 12 volt socket.*



**Fig. 134** Detailed view of the side trim in the luggage compartment: 12 volt socket

- Lift the power socket cover ⇒ Fig. 134.
- Insert the plug of the electrical appliance into the socket.

Electrical equipment can be connected to the 12 volt socket. The appliances connected to the socket must not exceed a power rating of 100 W. ►

**WARNING**

The power points, and any accessories connected to them are also functional with the ignition switched off or the key removed. To avoid the risk of injury, never leave children unsupervised in the vehicle.

**CAUTION**

Always use the correct type of plugs to avoid damaging the sockets.

**Note**

The use of electrical appliances with the engine switched off will cause a battery discharge.

**230 volt socket for Europlug\***

Electrical equipment can also be connected to the 230 volt socket in the centre console.

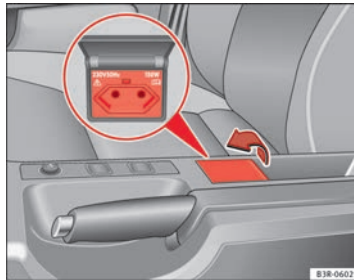

Fig. 135 Centre console:  
230 volt socket

The 230 Volt socket can only be used when the engine is running ⇒ ⚠.

**In vehicles with folding cover:**

- Hold the cover of the socket at the lower recess.
- Lift the cover to open ⇒ Fig. 135.

**Inserting the Europlug**

- Insert the Europlug in the socket. The childproof safety device on the socket is deactivated.
- If necessary, press the Europlug as far as possible into the socket to ensure it is correctly inserted and will not jump out of place while driving over a bump or similar.

**LED warning lamp above socket**

Steady green light:	The childproof safety device is disconnected. The socket is ready for use
Flashing red light:	There is a fault, for example, disconnection due to excess current or temperature

**Equipment which may be connected**

The 230 volt socket can be used to connect electrical equipment with a Europlug. Please note that the power consumption in this socket must not exceed 150 watts (peaks of 300 watts).

Even when more than one appliance is connected, the total consumption of all the appliances must not exceed 150 watts. If necessary, please refer to the manufacturer's label to confirm the power consumption of the connected equipment.

Connected equipment must be in perfect condition and show no signs of faults.

**WARNING**

- Heavy appliances or connectors (for example, adapters) which hang down directly from the Europlug socket may damage the socket with the resultant risk of injury.
- Ensure that appliances connected to the socket are secure to prevent them from being thrown around the vehicle in the event of sharp braking or an accident. This could result in severe injury or loss of life → page 16, Storing objects.
- Never spill liquid over the power socket– there is a risk of death. If any moisture enters the socket, ensure that it is thoroughly dry before using.
- Improper use of the sockets or electrical accessories can lead to serious injuries or cause a fire, with the resultant risk of injury.
- Children must never be left alone in the vehicle with the engine running. They could cause an accident.
- Appliances connected to the socket do not behave in the same way as when they are connected to the mains power supply. They may overheat during use and cause injury.
- When using adapters and extension leads, the childproof safety device on the 230 volt socket is disconnected and the socket is live. Risk of injury!
- Never insert objects which conduct electricity, such as a needle, in the pins of the 230 volt socket. There is a risk of death.
- Always switch off electrical appliances connected to the socket if the inverter goes off as a result of overheating. Failure to comply could result in injuries.

**CAUTION**

- The instructions for handling appliances connected to the socket must be observed.
- If the power consumption of the appliances connected exceeds 150 watts, the socket inverter will overheat. If the temperature exceeds a certain value, the inverter will switch off. It may also switch off if the outside temperature is very high, even if the power consumption is normal. The inverter will switch on again automatically after it has cooled down. Appliances connected to the socket, and which have been left switched on, will automatically come back on ⇒ ⚠.
- Do not connect neon lamps to the socket. For technical reasons, these could break down.
- Do not connect 115 volt appliances to the 230 volt power socket, as they could be damaged. If you have any queries, please check the manufacturer's label for details of the power supply accepted by the appliance.
- With some adapters, for example for laptops, their built-in overload disconnection system prevents the equipment from switching on in the event of an excessive start-up current. In this case, disconnect the adapter from the power supply and try to reconnect after ten seconds.

**Note**

- Non-insulated equipment may cause interference to the radio or vehicle electronics.
- The Europlug socket has a built-in childproof device and only carries live current when the Europlug is correctly plugged in.
- Some appliances may not operate correctly in the absence of adequate power (watts). ▶

- In some countries this socket is 115 volts. Therefore the socket should have a different inverter installed at the factory. You can obtain retrofit kits from your Technical Service. Do not connect 115 Volt appliances to the 230 Volt socket.
- The use of electrical equipment in the vicinity of the aerial in the rear window may cause interference to the reception of stations broadcasting in AM.

## Compartments

### Overview

*There are several storage compartments at various points in the vehicle.*

Your vehicle has the following storage compartments:

First-aid kit*	
Emergency triangle*	
Glove compartment	⇒ page 159
Storage compartment in the centre console	
On-board documentation compartment*	
Compartments in the door trims	⇒ page 160
Coat hooks	⇒ page 160
Side storage compartment in luggage compartment	

Some of the compartments listed are only provided in certain models or are optional extras.

### Glove compartment

*The lockable glove compartment is equipped with a light.*

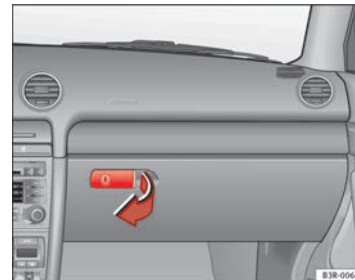

Fig. 136 Glove compartment

#### Opening the glove compartment

- Pull the handle on the lid in the direction indicated (arrow) ⇒ Fig. 136 and open the lid.

#### Closing the glove compartment

- Close the lid and push it in until it engages.

If the side lights or headlights are switched on, the light in the glove compartment comes on when it is opened.

The lid has separate holders for a pen and a note pad.

#### WARNING

**For safety reasons, the glove compartment must always be closed when the vehicle is moving. Failure to do so could result in an accident.**

### Compartments in the door trim

Storage compartments are provided in the door trims.

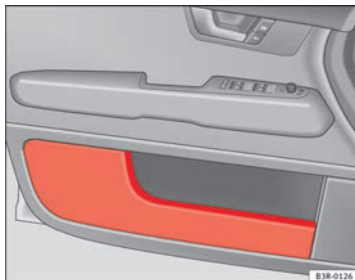

Fig. 137 Door trim with storage compartment

#### WARNING

The storage compartments in the door trims should only be used to store small objects. Make sure that they are stored safely inside the compartment, as they might otherwise impair the protection offered by the side airbags.

### Coat hooks

There is a coat hook above each of the rear doors.

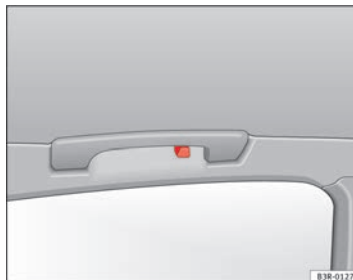

Fig. 138 Area above the rear doors: Coat hooks

#### WARNING

- Please make sure that any items of clothing hanging from the coat hooks do not obstruct your view to the rear.
- The coat hooks should only be used for lightweight clothing. Do not leave any heavy or sharp objects in the pockets.
- Do not use clothes hangers to hang up the clothing, as this could interfere with the function of the head-protection airbags\*.

### Compartments in the front seats

---

*There is a storage compartment with a lid at the front of each front seat.*

#### Opening

- Pull the handle to open the compartment.

#### Closing

- Close the lid and push it in until it engages.



#### Note

The compartments will hold a maximum weight of 1 kg.



## Air conditioning

### 2C-Climatronic

#### Description

*The air conditioner is designed to automatically keep the passenger compartment at the temperature you find most comfortable at all times of the year.*

Recommended settings:

- Set the temperature to 22°C (71°F).
- Press the **AUTO** ⇒ Fig. 139 button.

The following setting quickly provides a comfortable temperature inside the vehicle. We therefore recommend you do not modify the setting unless you find this temperature uncomfortable or where circumstances require as such.

The air conditioner provides heating and ventilation and also cools and dehumidifies the air inside the vehicle.

The air conditioner is fully automatic and will constantly maintain the temperature which has been set. To achieve this, the temperature of the air supplied to the interior, the blower speed (volume of air delivery) and the air distribution are regulated automatically. The system also takes solar radiation into account and, therefore, no subsequent manual readjustments are required. Therefore, **automatic mode** ⇒ page 165 should be used for the comfort of all the passengers in virtually all conditions throughout the year.

Please note the following points:

The humidity of the air is automatically reduced when the system cools the interior of the vehicle. This helps to prevent condensation on the windows.

If the humidity and temperature outside the vehicle are high, **condensation** can drip off the evaporator in the air cooling system and form a pool underneath the vehicle. This is normal and does not indicate a leak.

If the outside temperature is low, the blower normally only switches to a higher speed once the coolant has warmed up sufficiently (this does not apply to the defrost setting).

In order to achieve maximum engine power, the air conditioner compressor is temporarily switched off when pulling away from standstill with full throttle.

The compressor also switches off if the coolant temperature is excessively high to ensure adequate engine cooling under extreme loads.

#### Pollution filter

The pollution filter (a combined particulate filter and activated charcoal filter) serves as a barrier against impurities in the outside air, including dust and pollen.

For the air conditioner to work with maximum efficiency, the pollution filter element must be replaced at the intervals specified in the Service Plan.

If the vehicle is driven in areas with a high level of air pollution and the filter is no longer fully effective, it may be necessary to change the filter element more frequently. ▶

**CAUTION**

- If you suspect that the air conditioner system is damaged, switch over to ECON mode to prevent further damage and have the system checked by a specialised workshop.
- Repairs to the air conditioner require specialist knowledge and special tools. For this reason, please contact a specialised workshop if the system is not working properly.

**Note**

- Keep the air intake slots in front of the windscreen clear of snow, ice and leaves to ensure unimpaired heating and cooling and to prevent the windows misting over.
- The air from the outlets flows through the passenger compartment and out through the slots below the rear window. Therefore, do not cover these slots with items of clothing or other objects.
- The air conditioner operates most effectively with the windows and the sliding/tilting sunroof\* closed. However, if the vehicle has heated up after standing in the sun for some time, the air inside can be cooled more quickly by opening the windows briefly. ■

## Controls

This overview will help you become quickly familiar with the controls for the air conditioner.







Fig. 139 Air conditioner controls



The left-hand display shows the temperature selected for the left-hand side and the right-hand display the temperature for the right-hand side.



The functions can be switched on or off by briefly pressing the buttons. The diode on the buttons lights up when the function is enabled.

The grille between buttons  and  must be kept clear, as the temperature sensors are located behind the grille.

- Do not cover the grille.
- Do not clean the grille with a vacuum cleaner, as this could damage the temperature sensors located behind the grille.

Button(s)	Meaning
<b>AUTO</b>	Automatic mode
<b>- +</b> (left and right)	Temperature selection for driver and passenger sides
	Defrost
	Manual air recirculation mode
<b>ECON</b>	Switches off air cooling
<b>OFF</b>	Switches off air conditioner (instead of  )
	Automatic air recirculation mode (instead of <b>OFF</b> ) ▶

Button(s)	Meaning
– + (in the centre)	Adjusts blower speed
	Air to the windows
	Air from the dashboard outlets
	Air to the footwells

The ,  and  buttons (which regulate air distribution) can either be selected individually or in combination.

### Automatic mode

*Standard setting for all seasons.*

#### Switching on automatic mode

- It is possible to select interior temperatures from +18°C (64°F) to +29°C (86°F).
- Press the  ⇒ Fig. 139 button.

The automatic mode maintains a constant temperature inside the vehicle and dehumidifies the air. Air temperature, air delivery and air distribution are regulated automatically to reach the desired interior temperature as quickly as possible, and then to maintain this temperature. The system automatically compensates for any variations in the outside temperature and for the effect of direct sunlight.

The automatic temperature regulation only operates at temperature settings between +18°C and +29°C. If a temperature below +18°C is selected, **LO** appears on the display. If a temperature is selected which is higher than

+29°C, the display will show **HI**. In the maximum and minimum settings, the climate control operates continuously with maximum cooling or heating output and the temperature is not regulated automatically. The temperature is not regulated.





#### Note

By keeping the  button on the driver side pressed for several seconds, the temperature of the passenger side can be set to the temperature of the driver side or vice versa. The display indicates the new temperature value.

### Selecting the temperature

*Separate temperatures can be selected for the driver and front passenger sides.*



- Press the  or  buttons below the displays ⇒ Fig. 139 until the desired temperature is selected for the driver side or front passenger side.

The currently selected temperature setting is shown in the display above the buttons.

By keeping the  button on the driver side pressed for several seconds, the temperature of the passenger side can be set to the temperature of the driver side or vice versa. The display indicates the new temperature value. The previous temperature setting can be restored by resetting the display on the driver or passenger side as required.

### Defrosting

*The windscreen and side windows are defrosted or demisted as quickly as possible.*

- To enable this mode, press the  ⇒ Fig. 139 button.
- To switch off, press the  button again, or select the  button.

The temperature is regulated automatically. The air output is increased to maximum and most of the air comes out of outlets 1 and 2 ⇒ page 169.

The air recirculation and ECON modes are switched off when the  button is pressed.

### Air recirculation: manual activation

*The air recirculation setting prevents fumes etc. from entering the interior.*

#### Activating air recirculation mode

- Press button  ⇒ Fig. 139 ⇒ .

#### Deactivating air recirculation mode

- Press the  button again or
- Press the  button or
- Press button .

In this setting, the air in the vehicle is constantly recirculated. We recommend using the air recirculation mode in the following circumstances:

- When driving through a tunnel or in traffic congestions, to prevent exhaust gas entering the interior of the vehicle.





#### WARNING

**Do not drive for too long with the air recirculation mode enabled because, if the compressor is disconnected, the windscreen may mist up because no fresh air is entering the interior of the vehicle, with the subsequent risk of accidents.**

### ECON Mode (economy)

*ECON mode helps save fuel.*

- To activate, press the  button ⇒ Fig. 139.
- To deactivate, press the  button again or select the  button.

Air cooling is disconnected in ECON mode. The heating and the blower are adjusted automatically. “ECON” stands for “Economy”. Disconnecting air cooling (compressor) reduces fuel consumption.

Please note that the interior temperature must not be lower than the outside temperature in ECON mode. The blower does not cool or dehumidify the air in the interior. The windows could therefore mist up.

In diesel vehicles, the auxiliary heater is switched off in ECON mode to save fuel.

### Note

If the diode on the ECON button continues to light up when the ECON mode has been switched off (i.e. the air conditioner has been switched on) this is due to a defect in one of the air conditioner components. If a malfunction should occur, please contact a specialised workshop.

### Air recirculation: automatic activation\*

*If the outside air is polluted by diesel and petrol emissions, an air quality sensor in the vehicle will automatically switch on the air recirculation.*



Fig. 140 Button for automatic air recirculation

#### Activating air recirculation mode

- Press the button  ⇒ Fig. 140.

#### Deactivating air recirculation mode

- Press the  button again or



- Press the  button or
- Press button .

The automatic air recirculation mode should normally be left switched on at all times.

The system is ready to operate approx. 30 seconds after the engine ignition key has been turned. During this initial period, fresh air is fed into the vehicle.

If the **air purity sensor** in the air conditioner detects a certain concentration of fumes in the outside air, the control unit will either pass the incoming air through the pollution filter or automatically switch on the air recirculation. If there is a high concentration of pollution in the outside air, the air conditioner automatically switches to air recirculation and the supply of air from the outside is cut off. As soon as the level of pollution decreases, air is fed into the vehicle from the outside again.

The automatic air recirculation operates for a maximum period of 12 minutes. If the windows mist up when the automatic air recirculation is on, press the  button immediately.

The automatic air recirculation switches itself off under certain circumstances (for instance if  or  is selected). In "ECON" and at temperatures lower than approx. 8°C below zero, the automatic air recirculation mode is limited to 12 seconds.

### Switching the temperature display from °C to °F and vice versa

*The outside temperature indicator can be switched from °C (degrees Celsius) to °F (degrees Fahrenheit) and vice versa.*

- Press and hold the  button for air recirculation mode and briefly press the plus button of the left-hand temperature selector ⇒ Fig. 139.

### Switching the air conditioner on/off





#### Switching the air conditioner off: models with an button

- Press the  button. The air conditioner is switched off and the supply of air from outside the vehicle is cut off.

#### Switching the air conditioner off: models with a button





- Keep pressing the  button for the blower until the display segment is empty. The air conditioner is switched off and the supply of air from outside the vehicle is cut off.

#### Switching the air conditioner on: models with an button

- Press the  button again, or
- Press the  button or
- Press one of the air distribution buttons ,  or .

#### Switching the air conditioner on: models with a button



- Press the  button for the blower, or

- Press the  button or
- Press one of the air distribution buttons ,  or .

The air conditioner also starts to operate if one of the blower or temperature selector buttons is pressed. ■



### Blower speed

*The automatically selected blower speed can be reduced or increased manually.*

- Press the  and  buttons in the centre of the control panel ⇒ Fig. 139 to set the blower to the desired speed (and regulate the volume of air delivery).

The air conditioner system automatically regulates the blower speed according to the interior temperature. However, you can also adjust the air delivery manually. The current blower setting is illustrated by a bar in the middle display (above the buttons). ■

### Automatic change of passenger temperature

In order to automatically set the passenger temperature like the driver temperature, press the  button on the driver side for 2 seconds approximately. In order to automatically set the driver temperature like the passenger temperature, press the  button on the passenger side for 2 seconds approximately. ■

## Air outlets

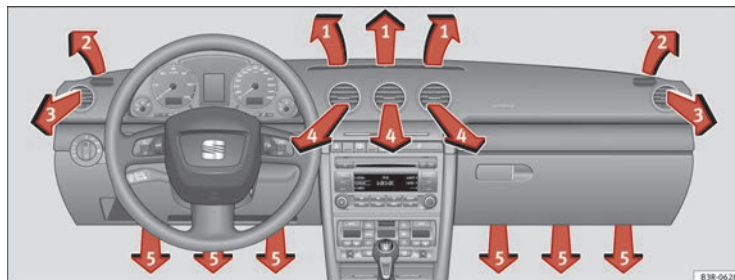

Fig. 141 Dash panel: Location of air outlets

The air outlets ⇒ Fig. 141 ③ and ④ can be operated as follows:

### Outlets ③ and ④

- The outlets can be opened and closed by turning the left thumbwheels.
- The direction of air delivery from the outlets can be varied as required using the adjuster in the centre of each outlet grille. The direction of air flow can be adjusted horizontally and vertically as desired.

The flow of air from the outlets is controlled either automatically or manually, depending on the operating mode selected. All the outlets can provide air that is either heated, unheated or cooled.



The heater outlets for the rear footwells are located under the front seats. They are controlled together with outlets ⑤.

### **i** Note

The cool air provided by the air conditioner is mainly issued from outlets ③ and ④. To ensure adequate cooling, outlets ③ and ④ should therefore never be closed completely.

## Air distribution

*The automatically-programmed air distribution can be altered manually.*

The buttons ,  and  can be operated either separately or in combination. To return to automatically controlled air distribution, switch off the selected functions separately or press the **AUTO** button

Each of the three buttons has a specific function. The numbers relate to the air outlets ⇒ Fig. 141.

**Air directed to windows** 

This setting directs all the air to outlets 1 and 2. Unlike in setting , the volume of air delivery remains the same.

**Air to the driver/front passenger** 

All the air comes from outlets 3 and 4 in the dash panel and from the rear of the centre console.

**Air to the footwells** 

Most of the air emerges from outlets 5 and the outlets under the front seats. Some of the air will also be issued from outlets 3 and 4.

**Note**

In all of the above air distribution settings, a small amount of air will still come from the other outlets.

**Economical use of the air conditioner**

*Economical use of the air conditioner will help save fuel.*

Engine power is reduced and fuel consumption increases when the air conditioner is in cooling mode. To ensure that the system is only switched on when it is really necessary, please note the following points:

- Select ECON mode if you wish to save fuel.
- Select ECON mode if you decide to open the windows or sunroof\* while driving.
- If the vehicle has heated up after standing in the sun, open the windows and doors for a short time to cool the vehicle.

**For the sake of the environment**

By saving fuel you also reduce the amount of pollutants emitted from your vehicle.

**Key settings**

*When the ignition is switched on, the air conditioner settings assigned to the key are selected automatically.*

The air conditioner settings selected are automatically stored and assigned to the key in use. When the vehicle is started, the air conditioner automatically selects the settings assigned to the key. Hence, every driver automatically obtains his/her preferred settings without having to select them manually.

**Note**

Should another driver use the key and enter other settings, the previous settings will be deleted.

**Solar-powered blower/sunroof\***

*If the vehicle is parked in sufficiently strong sunlight, the blower will operate in solar-powered mode when the ignition is switched off.*

After the ignition is switched off, the blower is supplied with electrical power from the sunroof. Please ensure that outlets 3 and 4 are open → Fig. 141 to ensure the best possible ventilation.

The blower only works when the sunroof is closed or tilted open at the rear. ▶

If the air recirculation mode is on when you switch off the engine, the air conditioner will automatically switch to fresh air ventilation.

### Auxiliary heater\*

Diesel vehicles are fitted with an auxiliary heater<sup>1)</sup> to raise the temperature of the interior as quickly as possible. At outdoor temperatures below +5°C and with the engine running, the supplementary heating will switch on and off automatically depending on the temperature of the coolant.

In order to save fuel, the auxiliary heater can be switched off by briefly pressing the **ECON** button on the air conditioner.

### Seat heating\*

*The surface and backrest of the front seats can be electrically heated.*

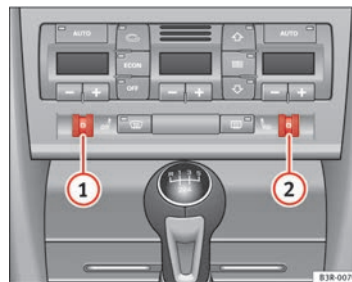

**Fig. 142 Detailed view of the dash panel: Thumbwheel controls for seat heating**

Turn thumbwheel ① or ② ⇒ Fig. 142 to switch on and adjust the heating on the left or right front seats.

The heating is switched off when the thumbwheel is set to 0. The temperature settings range from 1 to 6.

### ⚠ CAUTION

To avoid damaging the heating elements of the seat heating, please do not kneel on the seat or apply sharp pressure to a single point.

<sup>1)</sup> For Nordic countries only.

## Driving

### Steering

#### Adjusting the steering wheel position

*The height and reach of the steering wheel can be freely adjusted to suit the driver*

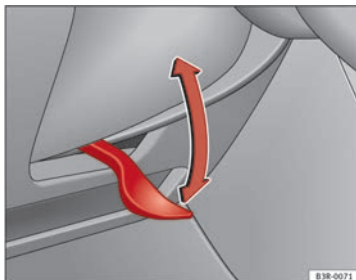

Fig. 143 Lever beneath steering column

- Push the lever ⇒ Fig. 143 down ⇒ ⚠.
- Move the steering wheel to the desired position.
- Then push the lever back up against the steering column until it engages in position.



#### WARNING

- Never adjust the position of the steering wheel when the vehicle is moving, as this could cause an accident.
- For safety reasons, the lever must always be securely engaged when the vehicle is moving, so that the position of the steering wheel cannot shift unexpectedly. Otherwise this could cause an accident.

## Safety

#### Electronic Stability Control (ESC)

*The ESC helps make driving safer in extreme driving conditions.*



Fig. 144 Detailed view of the centre console: ESC button

The Electronic Stability Control (ESC) contains the electronic differential lock (EDL) and the traction control system (ASR). The ESC works together with the ABS. If a fault in the ABS occurs, both warning lamps light up, but if the ESC fails, only the ESC warning lamp lights up.

The ESC system is started automatically when the engine is started.

The ESC system is always active and cannot be switched off. The ESC switch only switches the ASR off.

The ASR can be deactivated when wheel spin is desirable.

For example:

- When driving with snow chains.
- When driving in deep snow or on loose surfaces.
- When the vehicle is stuck, to rock it backwards and forwards.

Press the button to switch the ASR back on when you no longer need wheel spin.

#### Situations in which the warning lamp lights

- On switching the ignition on, it lights up for about two seconds to carry out a function control.
- The warning lamp will start flashing when the vehicle is moving if the ESC or the ASR is activated.
- It will light up continuously if there is a fault in the ESC.

#### WARNING

- Do not forget that the electronic stability control ESC cannot defy the laws of physics. This should be kept in mind, particularly on slippery and wet roads and when towing a trailer.
- Always adapt your driving style to suit the condition of the roads and the traffic situation. The greater safety provided by the ESC should not encourage you to run any risks.
- Please refer to the corresponding warning notes on ESC in [⇒ page 195, Intelligent technology.](#)

## Ignition lock

### Ignition key positions

The ignition key is used to start and stop the engine.

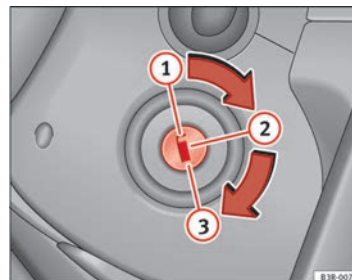

Fig. 145 Ignition key positions 

**Position ①**

The ignition key is inserted in this position. To **engage the steering wheel lock**, take out the key and turn the wheel until you hear the pin engage. You should always engage the steering lock when you leave the vehicle. This will help to deter thefts → ⚠.

**Switching on the ignition/pre-heating glow plugs ②**

If the key is difficult to turn in the lock, move the steering wheel (to take the load off the steering lock mechanism) until the key turns freely. In the case of vehicles with a diesel engine, the key is turned to this position to preheat the glow plugs.

**Starting the engine ③**

The engine is started in this position. Electrical components with a high power consumption are switched off temporarily.

After the engine has started, the ignition key returns to position ② by itself.

The ignition key has to be turned back to position ① before re-starting the engine. The **starter inhibitor** in the ignition lock prevents the starter motor from engaging when the engine is running, as this could cause damage.

**Switching off the ignition ①**

Turn the ignition key to this position.

**⚠ WARNING**

- **Never remove the ignition key until the vehicle is stationary! Otherwise the steering lock could engage suddenly, which could cause an accident.**
- **Always take the key with you when leaving the vehicle, even if you only intend to be gone for a short time. This is particularly important if there are children in the vehicle, as they might otherwise be able to start the engine or use power-operated equipment (e.g. the electric windows), which could cause injuries.**

**i Note**

- If the battery has been disconnected and then reconnected, it will be necessary to leave the key in position ② for about 5 seconds before starting the engine.
- Vehicles with automatic gearbox: After switching off the ignition, you can only remove the ignition key if the selector lever is in position "P" (parking lock). The selector lever is locked after the ignition key has been removed. ■

## Starting and stopping the engine

### Starting the engine

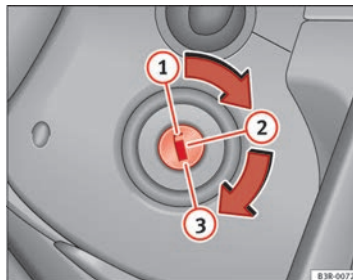

*The engine can only be started with an original SEAT key.*









**Fig. 146** Ignition key positions

**Vehicles with a petrol engine:**

- Use the foot brake. ▶

- Manual gearbox: Push the clutch pedal all the way down.
- Move the gear lever into neutral (automatic gearbox: selector lever to P or N) ⇒ .
- Turn the ignition key to position  without pressing the accelerator.
- Release the ignition key as soon as the engine starts (the starter motor must not be allowed to run on with the engine).

#### Vehicles with a diesel engine:

- Use the foot brake.
- Manual gearbox: Push the clutch pedal all the way down. Otherwise, the engine will **not** start.
- Move the gear lever into neutral (automatic gearbox: selector lever to P or N) ⇒ .
- Turn the ignition key to position . The pre-heating indicator light  comes on while the glow plugs are preheating.
- When the indicator light  goes out, turn the ignition key to position . Do not press the accelerator.
- Having completed the previous action the key can be released immediately, it will return to position  and the engine will have started.

When starting a very cold engine, it may be a little noisy for the first few seconds until oil pressure has built up in the hydraulic valve compensators. This is quite normal, and no cause for concern.

If the engine fails to start straight away, stop after 10 seconds and try again after about half a minute.

#### Glow plug system\*

To assist starting at low temperatures, **diesel engines** are equipped with a glow plug preheating system. The preheating time depends on the coolant temperature and the outside temperature. Start the engine *as soon as* the glow plug indicator light  goes out.

When the engine is warm or at outside temperatures above +8°C the glow plug indicator lamp will only light up for about one second. This means that the engine can be started *immediately*.

#### If the engine will not start...

- ⇒ page 293
- ⇒ page 297
- ⇒ page 230, Refuelling



#### WARNING

**Never run the engine in confined spaces, as the exhaust gases are poisonous.**



#### CAUTION

Avoid high engine speeds, full throttle and extreme load conditions until the engine has reached its normal operating temperature, otherwise this can damage the engine.



#### For the sake of the environment

Do not warm up the engine by running the engine with the vehicle stationary. Start immediately. This will help avoid unnecessary exhaust emissions. ■

### Stopping the engine

- Turn the ignition key to position  ⇒ Fig. 146. ▶

**WARNING**

- Never switch the engine off until the vehicle is stationary.
- The brake servo and the power steering system work only when the engine is running. You need more strength to steer and brake the vehicle when the engine is switched off. Given that you will be unable to steer and brake as usual, this could lead to a risk of accidents and injuries.

**CAUTION**

If the engine has been running under high load for a long time, there is a risk of heat building up in the engine compartment after the engine has been switched off; this could cause engine damage. Therefore, you should let the engine idle for approximately 2 minutes before you switch it off.

**Note**

After the engine is switched off the radiator fan may run on for up to 10 minutes, even if the ignition is switched off. It may also start running again after some time if the coolant temperature rises due to a build-up of heat under the bonnet, or if the engine is already warm and the engine compartment is heated up further by direct sunlight.

## Start-Stop function\*

### Description and operation

The Start-Stop function stops the engine when the vehicle is stopped and starts it automatically when required.

- When the vehicle is stopped, put it in neutral and release the clutch pedal. The engine will stop.

- When the clutch pedal is pressed, the engine starts again.
- The instrument panel screen displays information about the status of the Start-Stop function ⇒ Fig. 148.

### Start-Stop function conditions

- The driver seat belt must be buckled.
- The engine hood must be closed.
- The engine must be at operating temperature
- The steering wheel must not be turned more than 270°.
- The vehicle must not be on a steep gradient.
- The vehicle must not be in reverse.
- A trailer must not be connected.
- The temperature of the passenger compartment must be within the convenience limits (ECON) button should not be selected).
- The windscreen de-mist function must be off.
- **Otherwise** it requires more than 50% of the airflow that the fan can supply.
- The temperature must not be set to **HI** or **LO**.
- The driver door must be closed.
- The diesel particulate filter must not be in regeneration mode, for diesel engines.
- The battery charge must not be low for the next start.
- The battery temperature must be between -1°C and 60°C.

### Start-Stop function interruption

In the following situations, the Start-Stop function will be interrupted and the engine will automatically start:

- The vehicle starts moving.
- The brake pedal is pressed several times in a row.
- The battery has been discharged excessively.

- The Start-Stop System is manually deactivated.
- The windscreen de-mist function is turned on.
- The temperature of the passenger compartment exceeds the comfort limits (button **ECON** should not be selected).
- If more than 50% of the airflow that the fan can supply is ordered.
- Temperature setting **HI** or **LO** is selected.
- The engine coolant temperature is insufficient.
- The alternator is faulty, for example the V-belt has ruptured.
- If any of the conditions described in the previous section are not fulfilled.



### WARNING

Never allow the vehicle to move with the engine off for any reason. You could lose control of your vehicle. This could cause an accident and serious injury.

- **Power steering does not work when the engine is not running. That is why it is much more difficult to turn the steering wheel.**
- **Disconnect the Start-Stop system when driving through water (fording streams, etc.).**



### Note

- For vehicles with the Start-Stop function and a manual gearbox, when the engine is started, the clutch must be pressed.
- When the conditions for the Start-Stop function are not fulfilled, the instrument panel displays the Start-Stop indicator dimmed.
- If the steering wheel is turned more than 270°, Stop will not function; however, the angle of steering wheel turn does not affect starting the vehicle.

## Activating and deactivating the Start-Stop function



Fig. 147 The Start-Stop function button.

Every time the ignition is switched on, the Start-Stop function is automatically switched on.

### Manually deactivating the Start-Stop function

- Press the  => Fig. 147 button located on the centre console. When the Start-Stop function is deactivated, the pushbutton indicator lights.
- If the Start-Stop function is operating then the engine starts immediately.

### Switching the Start-Stop function on manually

- Press the  => Fig. 147 button located on the centre console. The indicator on the button will go out.

## Driver messages



Fig. 148 Display on the instrument panel during Start-Stop function operation.

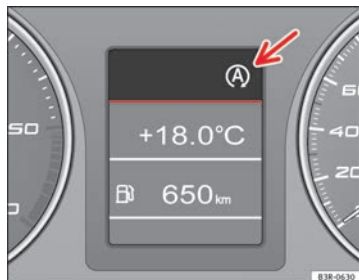

Fig. 149 Display on the instrument panel during Start-Stop function operation.

When the engine is turned off by the Start-Stop function, this is displayed on the instrument panel.

At each stop, the central Start-Stop symbol lights up for about 5 seconds. After this time, it turns off and the symbol on the upper right part of the display remains lit → Fig. 149.



### Note

- There are different versions of the dash panel; the display of indications on the screen may differ.
- Some indications/symbols of the Start\_stop system that appear in the upper part of the display may not be visible in the case of high priority indications (faults, fuel reserve indicator, windscreen washer liquid level, etc.). ■

## Warnings



Fig. 150 Driver warnings

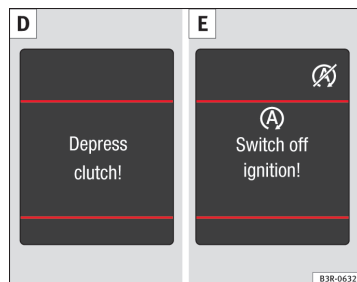

Fig. 151 Driver warnings

- A** Start the engine manually. Start-Stop system activated
- B** Start-Stop is not possible.

- C** Fault or warning with priority over the Start-Stop warnings that appear in the upper part of the display. Some Start-Stop warning in this zone may not be displayed.
- D** Press clutch pedal to start engine warning.
- E** On-screen message and audible warning of the Start-Stop system in the event that a door is opened and seat belt is unfastened in a stop phase.

## Handbrake

### Handbrake

*The handbrake should be applied firmly to prevent the vehicle from accidentally rolling away.*

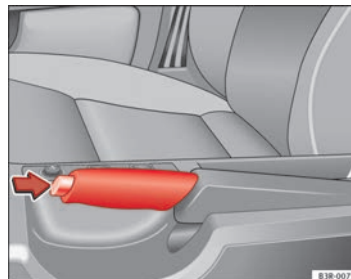



Fig. 152 Detailed view of the centre console: Handbrake on

### Applying the handbrake

- Pull the handbrake lever up all the way.

### Releasing the handbrake

- Pull the lever up slightly and *at the same time* press in the release button ⇒ Fig. 152 (arrow).
- Keep the release button pressed and push the lever all the way down ⇒ .

If you drive by mistake with the handbrake still applied, you will hear a warning buzzer and the display will show the message:

#### Handbrake on

The handbrake warning switches on after driving for 3 seconds at speeds above 5 km/h.

The handbrake warning lamp  lights up when the handbrake is applied with the ignition on.



#### WARNING

Please note that the handbrake should be released all the way. If it is only partially released, this will cause rear brakes overheating, which can impair the function of the brake system and could lead to an accident.



#### CAUTION

Once the vehicle has come to a standstill, always apply the handbrake firmly and then, on a manual gearbox, engage a gear, or select P on an automatic.

### Parking

*The following points will ensure there is no risk of the vehicle rolling away accidentally after it is parked:*

- Use the foot brake to stop the vehicle.
- Apply the handbrake firmly.
- Switch the engine off.
- On a manual gearbox engage 1st gear or on an automatic move the selector lever to P ⇒ .

#### When parking on slopes:

Turn the steering wheel so that the, if the vehicle moves, it will do so towards the curb.



#### WARNING

- Do not leave anyone (especially children) in the vehicle when it is locked. Locked doors could delay assistance in an emergency, potentially putting lives at risk.
- Never leave children unsupervised in the vehicle. They could release e.g. the handbrake or gear lever, moving the vehicle and causing an accident.

## Parking aid acoustic system

### General notes

Various systems are available to help you when parking or manoeuvring in tight spaces, depending on the equipment fitted on your vehicle.

The **SEAT Parking System** gives an acoustic warning if there are any obstacles *behind* your vehicle ⇒ page 181.

When you are parking, **SEAT Parking System Plus** warns you acoustically and optically about obstacles in front of and behind the vehicle ⇒ page 182.



#### Note

To ensure the acoustic parking aid works properly, the sensors must be kept clean and free of snow and ice.

### SEAT Parking System\*

*SEAT Parking System is an acoustic parking aid.*

Sensors are located in the rear bumper. When the sensors detect an obstacle, you are alerted by acoustic signals. The measuring range of the sensors starts at approximately:

Rear	Side	0.60 m
	Centre	1.60 m

The acoustic signals sound with increasing frequency as you approach the obstacle. When the vehicle is less than 0.30 m away from the obstacle, the warning tone will sound continuously. Do not drive on!

The volume of the warning beeps will be gradually reduced after about 4 seconds if the vehicle remains at a constant distance from a detected obstacle (it does not affect the permanent acoustic signal).

The parking aid is switched on automatically when reverse gear is engaged. You will hear a brief confirmation tone.



#### WARNING

- **The parking aid is not a replacement for driver awareness. The driver is personally responsible for safe parking and other manoeuvres.**
- **The sensors have blind spots in which obstacles are not registered. Always look out for small children and animals because the system will not always detect them. Always pay attention when reversing to avoid accidents.**
- **Always keep a close eye on the area around the vehicle and make full use of the rear view mirrors.**



#### CAUTION

Please note that low obstacles detected by the system may no longer be registered by the sensors as the vehicle moves closer, so the system will not give any further warning. Certain kinds of obstacles (such as wire fences, chains, thin painted posts or trailer draw bars, etc) may not always be detected by the system, so take care not to damage the vehicle in such cases.



#### Note

- Please refer to the notes on towing ⇒ page 183.

## SEAT Parking System Plus\*

SEAT Parking System Plus is an acoustic parking aid.

Sensors are located in the front and rear bumpers. When the sensors detect an obstacle, you are alerted by acoustic signals. The measuring range of the sensors starts at approximately:

Front	Side	0.90 m
	Centre	1.20 m
Rear	Side	0.60 m
	Centre	1.60 m

The acoustic signals sound with increasing frequency as you approach the obstacle. When the vehicle is less than 0.30 m from the obstacle the warning tone will sound continuously. Stop moving immediately!

The volume of the warning beeps will be gradually reduced after about 4 seconds if the vehicle remains at a constant distance from a detected obstacle (it does not affect the permanent acoustic signal). ■

## Activating/Deactivating



Fig. 153 Centre console: switch for parking aid

### Activating

- Engage reverse gear or
- Press the button **P** on the centre console ⇒ Fig. 153 or on the gear selector gate. You will hear a brief confirmation tone and the LED on the switch will light up.

### Deactivating

- Drive forward faster than 10 km/h, or
- Press the **P** button or
- Switch off the ignition or
- Disengage the reverse gear. ▶

**WARNING**

- The parking aid is not a replacement for driver awareness. The driver is personally responsible for safe parking and other manoeuvres.
- The sensors have blind spots in which obstacles are not registered. Always look out for small children and animals because the system will not always detect them. Always pay attention when reversing to avoid accidents.
- Always keep a close eye on the area around the vehicle and make full use of the rear view mirrors.

**CAUTION**

Please note that low obstacles detected by the system may no longer be registered by the sensors as the vehicle moves closer, so the system will not give any further warning. Certain kinds of obstacles (such as wire fences, chains, thin painted posts or trailer draw bars, etc) may not always be detected by the system, so take care not to damage the vehicle in such cases.

**Note**

- Please refer to the notes on towing ⇒ page 183.
- There is a slight delay in the picture display.

**Towing bracket\***

In towing mode, the rear parking aid sensors are not enabled when you select reverse gear or press the switch P<sub>⊖</sub>. This function may not be guaranteed on towing brackets that are not factory fitted. This results in the following restrictions:

**SEAT Parking System\***

There is no distance warning.

**SEAT Parking System Plus\***

There is no rear distance warning. The system will still give a warning when obstacles are detected while driving forward.

**Fault messages\***

If you hear a long beep for a few seconds and the LED on the P<sub>⊖</sub> button\* starts flashing when you switch on the parking aid, a system fault has occurred. Please have the fault corrected by a Technical Service or specialised workshop.

**Note**

If the fault is not corrected before you switch off the ignition, it will only be indicated by the flashing LED on the switch P<sub>⊖</sub>\* the next time you switch on the parking aid.

**Cruise speed\* (Cruise control system)****Introduction**

*The cruise control system allows you to maintain a constant speed.*

Using this system, any speed over 30 km/h can be kept constant, as long as the engine power allows it. This is subject to power output and braking ability of the engine. This helps to reduce fatigue, especially on long journeys.

The indicator lamp  on the instrument panel lights up when the cruise control system is operating.

**! WARNING**

For safety reasons, the cruise control system should not be used in dense traffic or poor road conditions (with ice, slippery surfaces, loose grit or gravel), as this could cause an accident.

**! CAUTION**

In vehicles with a manual gearbox: do not go into neutral if the device is enabled without previously releasing the clutch, as the engine will increase its revs and, under certain conditions, could break down.

**i Note**

The cruise control cannot maintain a constant speed when travelling down steep hills. The vehicle tends to accelerate under its own weight. Change down to a lower gear or use the foot brake to slow the vehicle.

### Setting the speed

*The desired cruising speed has to be stored in the memory.*

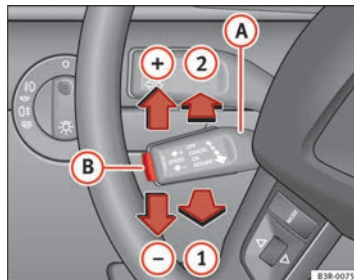

Fig. 154 Controls for the cruise control system

- Drive at the desired speed.
- Pull the lever **A** to position  $\Rightarrow$  Fig. 154 **1** to activate the system.
- Briefly press button **B**.

When button **B** is released, the current speed is stored in the memory and the vehicle will then maintain this speed.

## Adjusting the stored speed

The desired cruising speed can be adjusted up or down as required.

### Acceleration

- Move the lever **(A)** up towards **(+)**.
- Release the lever to store the current cruising speed.

### Deceleration

- Move the lever **(A)** down towards **(-)**.
- Release the lever to store the current cruising speed.

### Pressing lever **(A)** briefly

- You can increase the set speed in steps of 2 km/h by briefly pressing the lever **(A)** up towards **(+)**.
- You can decrease the set speed in steps of 2 km/h by briefly pressing the lever **(A)** down towards **(-)**.

You can also use the accelerator pedal momentarily to increase speed. The previously programmed speed will be automatically resumed when the accelerator pedal is released.

However, if the vehicle exceeds the programmed speed by more than 10 km/h for more than 5 minutes, the programmed speed will be deleted. You will then need to enter the speed again.

## Deactivating the cruise control temporarily

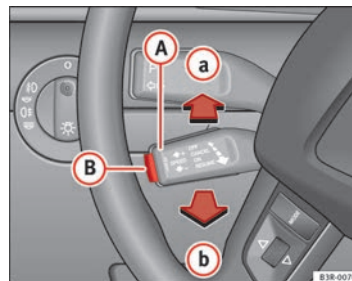

Fig. 155 Controls for the cruise control system

- Press the brake pedal or
- The clutch or
- Press the lever **(A)**  $\Rightarrow$  Fig. 155 to position **(a)** (click stop not engaged).
- Any intervention of the ASR or the ESC will switch off the cruise control.

The speed stored at this point remains in the memory if the system is only temporarily deactivated.

To resume the programmed cruising speed, release the clutch or brake pedal and pull the lever **(A)** to position **(b)**.

If no speed was stored when the system was temporarily disabled, a new speed can be set as follows: drive at the desired cruising speed and briefly press button  $\Rightarrow$  Fig. 154 **(B)** (SET).

**WARNING**

Retrieve the programmed speed only if this is not excessive for the current traffic conditions. Failure to do so could result in an accident.

### Deactivating the cruise control

#### While driving

- Move lever (A) ⇒ Fig. 154 to position (2) (click stop engaged).

#### While the vehicle is stationary

- Switch the ignition off.

## Manual gearbox

### Driving with a manual gearbox



Fig. 156 Detailed view of the centre console: gear shift pattern of a 6-speed manual gearbox

#### Engaging the reverse gear

- The vehicle should be stationary with the engine idling. Press the clutch down thoroughly.
- Place the gear lever into neutral and push the lever downwards.
- Slide the gear lever to the left, and then into the reverse position shown on the gear lever.

The reverse gear can only be engaged when the vehicle is stationary. When the engine is running and before engaging this gear, wait about 6 seconds with the clutch pressed down thoroughly in order to protect the gearbox.

The reverse lights light up when the reverse gear is selected and the ignition is on.

**WARNING**

- When the engine is running, the vehicle will start to move as soon as a gear is engaged and the clutch released.
- Never select the reverse gear when the vehicle is in motion. Risk of accident.

**Note**

- Do not rest your hand on the gear lever while driving. The pressure of your hand could cause premature wear on the selector forks in the gearbox.
- When changing gear, you should always depress the clutch fully to avoid unnecessary wear and damage.
- Do not hold the car “on the clutch” on hills. This causes premature wear and damage to the clutch.
- Do not leave your foot on the clutch pedal; although the pressure may seem insignificant, it can cause the premature wear of the clutch plate. Use the foot rest when you do not need to change gear.

## Automatic gearbox\*

### Introduction

*multitronic*<sup>®</sup>, *tiptronic* (7-speed gearbox)

#### Vehicles with multitronic<sup>®</sup> gearbox

The vehicle is equipped with an electronically controlled **continuously variable transmission** (multitronic<sup>®</sup>). Unlike conventional automatics, the gear ratios are not shifted in fixed steps but continuously variable. This gives smoother transmission and makes for better fuel economy.

The gearbox selects the gear ratio and shifts up or down automatically according to the gear change programmes stored in the control unit  
⇒ page 191.

If desired, you can also select the gears *manually* (**tiptronic mode**)  
⇒ page 192.

Please note that in vehicles with a multitronic<sup>®</sup> gearbox, torque is transmitted via a multi-plate clutch, and not via a torque converter as on conventional automatics. This means that the vehicle will not “creep” as much as conventional automatics when the engine is idling if you stop temporarily with the selector lever in position D, S or R.

#### Vehicles with tiptronic gearbox

The vehicle is equipped with an electronically controlled 7-speed automatic gearbox. The gearbox changes up and down *automatically*.

If desired, you can also select the gears *manually* (**tiptronic mode**)  
⇒ page 192.

## Driving instructions

*The gears are changed automatically.*



Fig. 157 Detailed view of the centre console: Selector lever with lock button

### Starting the vehicle

- Press and hold the brake pedal.
- Press and hold the interlock button (the button on the selector lever handle), move the selector lever to the required position, for instance D, and release the interlock button.
- Wait for the gearbox to engage the gear (a slight movement can be felt).
- Release the brake and press the accelerator ⇒ ⚠.

### Stopping briefly

- Apply the foot brake to hold the vehicle when stationary (for instance at traffic lights).

- To prevent the vehicle from rolling away, apply the parking brake before moving off on steep gradients ⇒ ⚠.

### Parking the vehicle

- Press and hold the brake pedal ⇒ ⚠.
- Apply the parking brake.
- Press and hold the interlock button, move the selector lever to P and release the interlock button.

The engine can only be **started** when the selector lever is at P or N.

On level ground it is sufficient to move the selector lever to P. On slopes, first engage the parking brake and then put the selection lever into the P position. This avoids overloading the locking mechanism and it will be easier to move the selector lever from position P.

Vehicles with multitronic® gearbox: Your vehicle is equipped with the **hill hold assist function** which makes it easier to start off on a slope. The system is activated when you press and hold the brake pedal for **a few seconds**. When you release the brake pedal the braking force will be maintained for a *short moment* in order to prevent the vehicle rolling back when you drive away.

### ⚠ WARNING

- **While you are selecting a gear and the vehicle is stopped with the engine running, do not accelerate. Failure to do so could result in an accident.**
- **Please note that some power will still be transmitted when you stop temporarily with the selector lever in position D, S or R. Therefore, when stopping you will need to press the brake with the force required to hold the vehicle still. Failure to do so could result in an accident.**
- **Never move the selector lever to R or P when driving, as this could cause an accident.**

## Selector lever positions

This section covers all the selector lever positions.

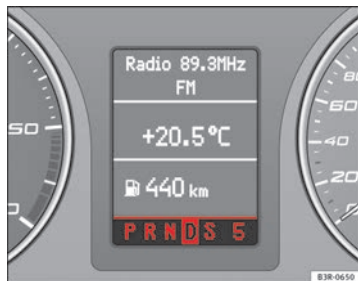

Fig. 158 Display: Selector lever positions

The current selector lever position is shown on the instrument panel display.

### P - parking lock

This locks the driving wheels mechanically. The parking brake should only be used when the vehicle is already *stopped* ⇒ ⚠.

The interlock button (the button on the selector lever handle) must be pressed in *and* the brake pedal must be depressed before moving the selector lever either in or out of position P. This is only possible when the ignition is on.

### R - Reverse gear

When reverse gear is engaged the gearbox automatically selects the **lowest gear ratio**.

The reverse gear may be engaged only when the vehicle is *stationary* and the engine is idling ⇒ ⚠.

To move the selector lever to position R, press in the interlock button *and* at the same time press the brake pedal. Depending on the model, one or two reverse lights will come on in selector lever position R (when ignition is switched on).

### N - Neutral (idling)

In this position the gearbox is in neutral ⇒ ⚠.

### D - Drive (forward)

In this position, the gearbox selects the optimal transmission ratio depending on the engine load, speed and the dynamic gear regulation programme (DRP).

Press the brake pedal when moving the selector lever from N to D if the vehicle is stationary or at speeds below 5 km/h ⇒ ⚠.

Under certain circumstances (e.g. when driving in mountains or towing a trailer or caravan) it can be advantageous to switch temporarily to tiptronic mode ⇒ page 192, so that the gear ratios can be selected *manually* to suit the driving conditions.

### S - Sport position

To drive in sports mode, select the position S. The engine power reserve is used to its maximum. When accelerating the gear shifts will be noticeable.

Press the brake pedal when moving the selector lever from N to S if the vehicle is stationary or at speeds below 5 km/h ⇒ ⚠.

### ⚠ WARNING

- Never move the selector lever to R or P when driving. Failure to do so could result in an accident.
- In selector position D or S the vehicle must always be held with the foot brake when the engine is running. This is because an automatic gearbox still transmits power even at idling speed, and the vehicle tends

**⚠ WARNING (Continued)**

to “creep”. The throttle must on no account be opened inadvertently (for instance by hand from the engine compartment) when a gear is engaged with the vehicle stationary. The vehicle could otherwise start moving immediately (in some cases even if the parking brake is engaged) and possibly cause an accident.

- To avoid accidents, apply the parking brake and put the selector lever in position P before opening the bonnet and working on the vehicle with the engine running. Please observe the important safety warnings ⇒ page 234, Work in the engine compartment.



**Note**

- Applies to vehicles with tiptronic gearbox:
- If the lever is moved accidentally to N when driving, release the accelerator and let the engine speed drop to idling before selecting D or S again.
- For the sake of fuel economy (and the environment), the gearbox ratios on some models are designed so that maximum speed is only obtained when the gear lever is in position S.

## Selector lever lock

*The selector lever lock prevents gears from being engaged inadvertently, so that the vehicle is not set in motion unintentionally.*

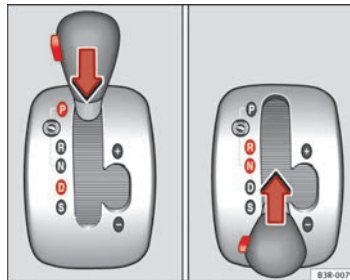

**Fig. 159 Selector lever lock functions**

The selector lever lock is released as follows:

- Switch the ignition on.
- Press the brake pedal *and* at the same time press in the interlock button.

### Automatic selector lever lock

With the ignition turned on, the selector lever is locked in the positions P and N. To remove it from these positions, press on the brake. The following message appears in the instrument panel as a reminder for the driver when the selector lever is in position P or N:

**WHEN STATIONARY APPLY FOOTBRAKE WHILE SELECTING GEAR**

The selector lever lock only works if the vehicle is stationary or driving at speeds up to 5 km/h. At higher speeds the selector lever lock in the N position is disengaged automatically.

The selector lever lock is not engaged if the selector lever is moved quickly through position N (e.g. when shifting from R to D). This makes it possible, for instance, to "rock" the vehicle backwards and forwards if it is stuck in snow or mud. The selector lever lock engages automatically if the brake pedal is not depressed and the lever is in position N for more than about a second.

#### Interlock button

The interlock button on the selector lever handle prevents the driver from inadvertently engaging particular gears. Press the button in to disengage the selector lever lock. The selector lever positions in which the interlock button has to be pressed are shown in the illustration, highlighted in colour ⇒ Fig. 159.

#### Safety interlock for ignition key

Once the ignition has been turned off, the key may be removed only if the gear selector is in position P. While the key is not in the ignition, the selector lever is locked in position P.

### Kick-down feature

*This feature allows maximum acceleration.*

#### Vehicles with multitronic® gearbox

When the accelerator pedal is pressed right down past the point of resistance at full throttle, the gearbox will select a lower gear ratio, depending on road speed and engine speed. While you keep the accelerator depressed the engine speed is automatically controlled to give your vehicle maximum acceleration.

#### Vehicles with tiptronic gearbox

When the accelerator pedal is pressed right down past the point of resistance at full throttle, the gearbox will shift down to a lower gear, depending on road speed and engine speed. The upshift to the next higher gear is delayed until the engine reaches maximum rpm.



#### WARNING

Please note that if the road surface is slippery or wet, the kick-down feature could cause the driving wheels to spin, which could result in skidding.

### Dynamic gear control programme (DCP)

*The automatic gearbox is controlled electronically.*

The vehicle is equipped with an electronically controlled gearbox. The gear ratios are selected automatically according to preset gearshift programmes.

When you drive at **moderate speeds** the gearbox will select the most economical shift programme. It will then change up early and delay the downshifts to give better fuel economy.

If you drive at **higher speeds** with heavy acceleration, if you open the throttle quickly, or if you use the kick-down or the vehicle's maximum speed, the gearbox will automatically select the sport programme.

The gearbox is self-adapting, and continuously selects the most suitable shift programme. At the same time, the driver can also make the gearbox switch to the sport programme by pressing the accelerator quickly. This makes the gearbox shift down into a lower gear ratio, allowing a more rapid acceleration (for instance to pass another vehicle), without having to press the accelerator all the way down into the kick-down position. After the gearbox has shifted back up it returns to the original programme, depending on your style of driving.

Vehicles with multitronic® gearbox: the gearbox continuously adapts the gear ratios to gradients. If the brake pedal is pressed on a downhill gradient the gearbox automatically shifts to a lower gear ratio. This increases the engine braking effect.

Vehicles with tiptronic gearbox: in mountainous areas, the gearbox adapts the gears for uphill and downhill gradients. This helps to avoid constant gear changes on uphill gradients. ■

### Manual gear selection (tiptronic mode)

*With the manual shift programme (tiptronic) the driver can manually select pre-programmed gears.*



Fig. 160 Centre console: Manual gear selection (tiptronic mode)

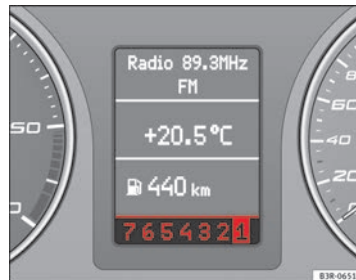

Fig. 161 Display: Manual gear selection (tiptronic mode)

#### Switching over to the manual programme

- Move the selector lever from the position D to the right-hand side. As soon as the selector lever has entered the tiptronic rail, the gear engaged is displayed on the screen.

#### Shifting up a gear

- Briefly push the selector lever forwards (in the tiptronic gate) ⇒ Fig. 160 (+).

#### Shifting down a gear

- Briefly pull the selector lever backwards (in the tiptronic gate) (-).

With the tiptronic system, the driver can manually choose between eight (in vehicles with multitronic) or seven (in vehicles with tiptronic) different gear programmes. The manual programme can be selected either with the vehicle stationary or on the move.

When accelerating, the gearbox automatically shifts up into the next gear shortly before the maximum engine speed is reached. ▶

If you select a gear which is lower than the gear shown on the instrument panel display → Fig. 161, the gearbox will only shift down when there is no longer a risk of over-revving the engine.

When the vehicle slows down (for instance when braking), the gearbox automatically shifts down into the next gear when the minimum engine speed is reached.

Changing down to a lower gear increases the engine braking effect on downhill gradients.

When the accelerator pedal is pressed right down past the point of resistance at full throttle, the gearbox will select a lower gear ratio, depending on road speed and engine speed. ■

### Back-up programme

*A back-up system is in place if a fault should occur in the control system.*

The automatic gearbox switches to the back-up programme if a fault should occur in the control system. This is indicated by a gear pinion symbol which lights up on the instrument panel display.

It is still possible to move the selector lever to all positions. The manual shift programme (tiptronic) is not available when the back-up programme is active.

Vehicles with tiptronic gearbox: When the selector lever is in position D or S or in the manual shift programme, the gearbox will remain in 3rd gear if 1st, 2nd or 3rd gears were engaged when the fault occurred. The gearbox will remain in 5th gear if 4th, 5th or 6th gears were engaged. The gearbox will then engage 3rd gear when you drive away from a standstill or after the engine is restarted.

It will still be possible to use reverse gear in the normal way. However, the electronic lock for reverse gear will be switched off.

### ⚠ CAUTION



Should the gearbox ever switch into the back-up programme, you should take the vehicle to a technical service or specialised workshop as soon as possible. ■

### Steering wheel with paddle levers

*The paddle levers on the steering wheel enable the driver to manually select pre-programmed ratios or gears.*



Fig. 162 Steering wheel: tiptronic controls

- Briefly pull the left-hand paddle lever  to change down to a lower gear.
- Briefly pull the right-hand paddle lever  to change up to a higher gear. ▶

The paddle levers are activated when the selector lever is in position D or S, or the position for the manual shift programme (tiptronic).

The manual shift programme can, of course, still be operated using the gear lever in the centre console. ■

## Practical Tips

### Intelligent technology

#### Electronic Stability Control (ESC)

##### General Observations

*The Electronic Stability Control increases the vehicle's stability on the road.*



Fig. 163 Centre console with ESC switch

The ESC is designed to increase the degree of control in situations where the vehicle approaches the limits of adhesion, especially when accelerating and cornering. It reduces the risk of skidding and improves stability in all road conditions. The system is active across the entire speed range.

The anti-lock brake system (ABS), the electronic differential lock (EDL) and the traction control system (ASR) are all integrated into the Electronic Stability Control.

##### How it works

The ESC control unit processes data from the three integrated systems. It also processes additional inputs provided by other high-precision sensors. These register the vehicle's rotation about the vertical axis (yaw rate), lateral acceleration, brake pressure and steering wheel angle.

The system uses the steering wheel angle and road speed to calculate the changes of direction desired by the driver, and constantly compares them with the actual behaviour of the vehicle. If the desired course is not being maintained (for instance, if the vehicle is starting to skid), then the ESC compensates automatically by braking the appropriate wheel.

The forces acting on the braked wheel bring the vehicle back to a stable condition. If the vehicle *over* swerves (tendency of the rear to leave the road), the brakes will act on the front wheel facing the outside of the bend. If the vehicle *under* swerves (tendency to leave the bend), the braking force is applied to the rear wheel facing the inside of the bend.

The ESC works in conjunction with the ABS ⇒ page 196. If a malfunction should occur in the ABS, the ESC will also stop working.

##### Deactivating

The ESC is activated automatically when the engine is started and performs a self-test routine.

The ESC cannot be deactivated. ▶

 **WARNING**

The ESC is not able to overcome the physical limits of adhesion. Even with ESC, you should always adjust your speed to suit the road and traffic conditions. Please bear this in mind, especially on wet or slippery road surfaces. Do not let the extra safety features tempt you into taking any risks when driving. Failure to do so could result in an accident. ■

### Anti-lock brake system (ABS)

*ABS prevents the wheels from locking up under braking.*

The anti-lock brake system (ABS) is an important part of the vehicle's active safety system. However, the ABS will not necessarily guarantee shorter *stopping distances* in all conditions. For instance, on loose gravel or fresh snow on top of an icy surface (conditions which anyway require extreme care and reduced speed), the stopping distance with ABS may even be slightly *longer*.

#### How the ABS works

The system runs an automatic self-check when the vehicle reaches a road speed of about 6 km/h. This may be accompanied by a noise from the ABS pump.

When one of the wheels is turning very slowly in relation to the road speed and is close to locking up, the system will reduce the brake pressure on that wheel. The driver is made aware of this adjustment process by a **vibration of the brake pedal** and an audible noise. This is a deliberate warning to the driver that one or more of the wheels is tending to lock up and the ABS control function has intervened. In this situation it is important to keep the brake pedal fully depressed so the ABS can regulate the brake application, but do not "pump" the brake pedal.

 **WARNING**

The grip provided by ABS is still subject to the physical limits of adhesion. Always bear this in mind, especially on wet or slippery roads. If you notice that the ABS is working (to counteract locked wheels under braking), you should reduce speed immediately to suit the road and traffic conditions. Do not let the extra safety features tempt you into taking any risks when driving. Failure to do so could result in an accident.

**Note**

If a malfunction should occur in the ABS, this is indicated by a warning lamp ⇒ page 70. ■

### Brake assist system

*The brake assist system helps the driver to achieve optimum braking effect.*

The brake assist system helps to increase braking power and thus to achieve a shorter stopping distance. If the driver presses the brake pedal very quickly, the brake assist system automatically boosts the braking force to the maximum level, up to the point where the anti-lock brake function (ABS) intervenes to stop the wheels from locking. You should then keep the brake pedal pressed until the vehicle has braked to the required speed. The brake assist system switches itself off as soon as you release the brake pedal.

The brake assist system will not be operative if there is a malfunction in the ABS or the ESC. ▶

 **WARNING**

Please remember that the accident risk always increases if you drive too fast, especially in corners or on a slippery road, or if you follow too close behind the vehicle in front of you. An increased accident risk cannot be compensated even by the brake assist system. Risk of accident.

### Electronic differential lock (EDL)

*The electronic differential lock prevents the loss of traction caused if one wheel starts spinning.*

#### General notes

The electronic differential lock (EDL) helps the vehicle to start moving, accelerate and climb a gradient in slippery conditions where this may otherwise be difficult or even impossible.

#### How it works

The EDL works automatically, without the driver's involvement. With the aid of the ABS sensors, the system monitors the rotational speed of the drive wheels → page 196. If a considerable *difference in revs* is detected (approx. 100 rpm) in the speed of the drive wheels, e.g. when only *one part* of the surface supporting the wheels is slippery, the system applies the brake to slow down the skidding wheel so that more of the power is directed to the other wheels. The system works up to a speed of approx. 80 km/h. The system will make noise while it is working.

#### Starting the vehicle

If one wheel has less grip and starts spinning (for instance, if one of the drive wheels is on ice), keep pressing the accelerator gradually until the vehicle starts moving.

#### Overheating of the brakes

To prevent the brake disk of the braked wheel from overheating, the EDL cuts out automatically if subjected to excessive loads. In this case, the vehicle will continue to run and will have the same running properties as those of another without EDL.

The EDL will switch on again automatically when the brake has cooled down.

 **WARNING**

- When accelerating on a uniformly slippery surface (for instance all four wheels on ice or snow), press the accelerator gradually and carefully. Despite EDL, the drive wheels may otherwise start to spin. This could impair the vehicle's stability. Risk of accident.
- Even with EDL, you should always adjust your speed to suit the road and traffic conditions. Do not let the extra safety features tempt you into taking any risks when driving. Failure to do so could result in an accident.

 **Note**

If the ABS warning lamp lights up, this can also mean there is a fault in the EDL. Take the vehicle to a specialised workshop as soon as possible.

### Traction control system (ASR)

*The traction control system prevents the drive wheels from spinning when the vehicle is accelerating.*

#### General notes

The traction control system (ASR) is one of the functions incorporated in the Electronic Stability Control (ESC)

The traction control system (ASR) helps the car to start moving, accelerate and climb a gradient in slippery conditions where this may otherwise be difficult or even impossible.

#### How it works

The ASR works automatically, i.e. without the driver's involvement. With the aid of the ABS sensors, the ASR monitors the speed of the driven wheels → page 196. If the wheels start to spin, the engine speed is reduced automatically to match the amount of grip available. The system is active across the entire speed range.

The ASR works in conjunction with the ABS. If a failure occurs in the ABS, the ASR will also stop working.

In general, the ASR should be left switched on at all times. It should only be switched off manually in particular circumstances where a certain amount of wheel slip may be desirable. Examples:

- when driving with snow chains
- when driving in deep snow or on loose surfaces
- when rocking the vehicle backwards and forwards to free it.

The ASR should be switched on again afterwards as soon as possible.



#### Note

To ensure that the ASR works properly, all four wheels must be fitted with identical tyres. The difference in size of the wheels may lead to an undesired reduction in engine power. Also see → page 255.

## Brakes

### General notes

---

#### New brake pads

New brake pads do not provide optimal performance during the first 200 km; first they must be “run in”. However, the reduced braking capacity may be compensated by pressing on the brake pedal a little harder. Avoid overloading the brakes during run-in.

#### Wear

The rate of wear on the **brake pads** depends a great deal on how you drive and the conditions in which the vehicle is operated. Negative factors are, for instance, city traffic, frequent short trips or hard driving with abrupt starts and stops.



#### Wet roads or road salt

In certain conditions, such as in heavy rain, or after washing the vehicle or driving through water, the full braking effect can be delayed by moisture (or in winter by ice) on the discs and brake pads. In this case the brakes should be dried by pressing the brake pedal several times.

The effectiveness of the brakes can also be temporarily reduced if the vehicle is driven for some distance without using the brakes when there is a lot of salt on the road in winter. In this case, the layer of salt on the brake discs and pads has to wear off before braking.

#### Corrosion

There may be a tendency for corrosion to form on the discs and dirt to build up on the brake pads if the vehicle is used infrequently or the brakes are not used very often.

If the brakes are not used frequently, or if rust has formed on the disks, it is advisable to clean off the pads and disks by braking firmly a few times at a moderately high speed → . 

### Faults in the brake system

If the brake pedal travel should ever increase *suddenly*, this may mean that one of the two brake circuits has failed. Drive immediately to the nearest specialised workshop and have the fault repaired. Drive there slowly and remember that you will have to apply more pressure on the brake pedal and allow for longer stopping distances.

### Low brake fluid level

Malfunctions can occur in the brake system if the brake fluid level is too low. The brake fluid level is monitored electronically.



#### WARNING

When applying the brakes to clean off deposits on the pads and discs, select a clear, dry road. Be sure not to inconvenience or endanger other road users. Risk of accident.



#### CAUTION

- Never let the brakes “drag” by leaving your foot on the pedal when it is not necessary to brake. This overheats the brakes, resulting in longer stopping distances and greater wear.
- Before driving down a long, steep gradient, it is advisable to reduce speed and change to a lower gear (or move the gear lever to a lower gear position if your vehicle has automatic transmission). This makes use of engine braking and prolongs the service life of the brakes. If you still have to use the brakes, it is better to brake firmly at intervals than to apply the brakes continuously.



#### Note

If you wish to equip the vehicle with accessories such as a front spoiler or wheel covers, it is important that the flow of air to the front wheels is not obstructed, otherwise the brakes can overheat.

### Brake servo

*The brake servo assists the driver when braking*

The brake servo increases the pressure you apply to the brake pedal. The brake servo works only when the engine is running.



#### WARNING

Ensure the vehicle does not move while in neutral, when the engine is stopped. Failure to do so could result in an accident.



#### Note

If the brake servo is not working, e.g. because the vehicle has to be towed or because it is broken, you will have to press the brake pedal considerably harder to make up for the lack of servo assistance.

### Power steering

*Power steering makes it easier to turn the steering wheel when the engine is running.*

Power steering assists the driver by reducing the force needed to turn the steering wheel.

Power steering does not work if the engine is off. In this case the steering wheel requires much more force to turn.

If the steering is held at its *turning limit* when the vehicle is stationary, this will place an excessive load on the power steering system. Turning the steering wheel to its limit places a load on the system, which causes noise. It will also reduce the idling speed of the engine.

**CAUTION**

When the engine is running, do not turn the steering wheel to its limit for more than 15 seconds. Otherwise, there is a risk of damaging the power steering.

**Note**

- If the power steering should fail at any time or the engine is switched off (for instance when being towed), the vehicle can still be steered. However, more effort will be required to turn the steering wheel.
- If the system is leaking or malfunctioning, please take the vehicle to a specialised workshop as soon as possible.
- The power steering system requires a special hydraulic fluid. The fluid reservoir is located at the front of the engine compartment on the left → page 304. The correct fluid level in the reservoir is important for the power steering to function properly. The hydraulic fluid level is checked at the Inspection Service. ■

## Servotronic\*

---

*The servotronic system electronically adjusts the power assisted steering.*

In vehicles equipped with servotronic power steering the degree of power assistance → page 199 is adjusted *electronically* according to road speed.

If a fault should occur in the *servotronic* system, the *power steering* will still operate. The degree of power assistance will, however, no longer adapt to different speeds. If the electronic regulating system is not working properly, this is most noticeable when turning the steering wheel at low speeds (for instance when parking), as more effort will be required than usual. The fault should be corrected by a specialised workshop as soon as possible. ■

## Driving and the environment

### Running-in

#### Running in a new engine

*The engine needs to be run in over the first 1500 km.*

##### Up to 1000 kilometres

- Do not drive at speeds of more than 2/3 the maximum speed.
- Do not accelerate hard.
- Avoid high engine revolutions.
- Do not tow a trailer.

##### From 1000 to 1500 kilometres

- Speeds can be *gradually* increased to the maximum road speed or maximum permissible engine speed (rpm).

During its first few hours of running, the internal friction in the engine is greater than later on, when all the moving parts have bedded in.



#### For the sake of the environment

If the engine is run in gently, its life will be increased and its oil consumption reduced.

#### Braking capacity and braking distance

*The braking capacity and braking distance are influenced by driving situations and road conditions.*

The efficiency of the brakes depends directly on the **brake pad** wear. The rate of wear of the brake pads depends to a great extent on the conditions under which the vehicle is operated and the way the vehicle is driven. If you often drive in town traffic, drive short distances or have a sporty driving style, we recommend that you have the thickness of your brake pads checked by a Technical Service more frequently than recommended in the Service Plan.

If you drive with **wet brakes**, for example, after crossing areas of water, in heavy rainfall or even after washing the vehicle, the effect of the brakes is lessened as the brake discs are wet or even frozen (in winter). In this case the brakes should be dried by pressing the brake pedal several times.



#### WARNING

Longer braking distances and faults in the brake system increase the risk of accidents.

- New brake pads must be run in and do not have the correct friction during the first 200 km. However, the reduced braking capacity may be compensated by pressing on the brake pedal a little harder. This also applies when the brake pads have to be changed further on.
- If brakes are wet or frozen, or if you are driving on roads which have been salted, braking power may be lower than normal.

**⚠ WARNING (Continued)**

- On steep slopes, if brakes are excessively used, they will overheat. Before driving down a long steep slope, it is advisable to reduce speed and change down into a lower gear or range (depending on the type of transmission). This makes use of engine braking and relieves the brakes.
- Never let the brakes “drag” by applying light pressure. Continuous braking will cause the brakes to overheat and the braking distance will increase. Apply and then release the brakes alternately.
- Never let the vehicle run with the engine switched off. The braking distance is increased considerably when the brake servo is not active.
- If the brake fluid loses its viscosity and is subjected to heavy use, vapour bubbles can form in the brake system. This reduces the efficiency of the brakes.
- Non-standard or damaged front spoilers could restrict the airflow to the brakes and cause them to overheat. Before purchasing accessories please observe the relevant instructions → page 228, Technical modifications.
- If a brake circuit fails, the braking distance will be increased considerably. Contact a specialised workshop immediately and avoid unnecessary journeys.

## Exhaust gas purification system

### Catalytic converter\*

#### To maintain the useful life of the catalytic converter

- Use only unleaded petrol with petrol engines, as lead damages the catalytic converter.
- Do not let the fuel get too low in the tank.

- For engine oil changes, do not replenish with too much engine oil ⇒ page 237.
- Never tow the vehicle to start it, use jump leads if necessary ⇒ page 293.

If you notice misfiring, uneven running or loss of power when the vehicle is moving, reduce speed immediately and have the vehicle inspected at the nearest specialised workshop. In general, the exhaust gas warning lamp will light up when any of the described symptoms occur ⇒ page 68. If this happens, unburnt fuel can enter the exhaust system and escape into the environment. The catalytic converter can also be damaged by overheating.

**WARNING**

The catalytic converter reaches very high temperatures! There is a risk of fire.

- Never park where the catalytic converter could come into contact with dry grass or flammable materials under the vehicle.
- Do not apply additional underseal or anti-corrosion coatings to the exhaust pipes, catalytic converter or the heat shields on the exhaust system. These materials could catch fire when the vehicle is being driven.

**CAUTION**

Never run the fuel tank completely dry because the irregularity of the fuel supply may cause ignition problems. This allows unburnt fuel to enter the exhaust system, which could cause overheating and damage the catalytic converter.

**For the sake of the environment**

Even when the emission control system is working perfectly, there may be a smell of sulphur from the exhaust gas under some conditions. This depends on the sulphur content of the fuel used. Quite often the problem can be solved by changing to another brand of fuel.

## Diesel engine particulate filter\*

*The diesel engine particulate filter eliminates soot produced by burning diesel.*

The diesel engine particulate filter eliminates most of the soot from the exhaust gas system. Under normal driving conditions, the filter cleans itself. If the driving conditions do not allow the filter to clean itself (for example, multiple short trips) the filter will be obstructed by dust and pollen and the indicator  for the diesel engine particulate filter indicator will light up. This does not represent a fault, it is a warning that indicates that the filter has not been able to regenerate automatically and that you must carry out a cleaning cycle, as indicated in ⇒ page 83.

### WARNING

- The diesel engine particulate filter may reach extremely high temperatures; the vehicle should be parked so that the exhaust pipe does not come into contact with flammable materials underneath the vehicle. Otherwise there is a risk of fire.

### CAUTION

- Your vehicle is **not** designed to use biodiesel fuel. **Never, under any circumstances** refuel with biodiesel. The use of biodiesel fuel could damage the engine and the fuel system. The addition of biodiesel to diesel by the diesel producer in accordance with standard EN 590 is authorised and will not cause damage to the engine or the fuel system.
- Using diesel fuel with a high sulphur content may significantly reduce the useful life of the diesel particulate filter. Your Technical Service will be able to tell you which countries have diesel with a high sulphur content.

## Economical and environmentally friendly driving

### Economical and environmentally friendly driving

Fuel consumption, environmental pollution and wear to the engine, brakes and tyres depends in large part on your driving style. By adopting an economical driving style and anticipating the traffic situation ahead, you can easily reduce fuel consumption by 10-15%. Some tips on how to help you reduce pollution while saving money are listed below.

#### Drive anticipating the traffic situation

A vehicle uses most fuel when accelerating. When you anticipate the situation, you have to brake less often and, thus, accelerate less. If it is possible, let the vehicle roll with a **gear engaged**, for example, if you see a red light ahead. The braking effect achieved in this way helps to reduce the wear of brakes and tyres; emissions and fuel consumption are reduced to zero (disconnection due to inertia).

#### Change gear early to save energy

An effective way of saving fuel is to change up *quickly* through the gears. Running the engine at high rpm in the lower gears uses an unnecessary amount of fuel.

**Manual gearbox:** Change from first to second gear as quickly as possible. We recommend that, whenever possible, you change to a higher gear upon reaching 2000 rpm. Follow the “recommended gear” indication that appears on the instrument panel ⇒ page 76.

#### Avoid driving at high speed

We advise you not to drive at the top speed permitted by the vehicle. Fuel consumption, exhaust emissions and noise levels all increase very rapidly at higher speeds. Driving at moderate speeds will help to save fuel. ▶

### Avoid idling

It is worthwhile switching off the engine when waiting in a traffic jam, at level crossings or at traffic lights with a long red phase. The fuel saved after only 30 - 40 seconds is greater than the amount of fuel needed to restart the engine.

The engine takes a long time to warm up when it is idling. Mechanical wear and pollutant emissions are also especially high during this initial warm-up phase. It is therefore best to drive off immediately after starting the engine. Avoid running the engine at high speed.

### Periodic maintenance

Periodic maintenance work guarantees that, before beginning a journey, you will not consume more than the required amount of fuel. A well-serviced engine gives you the benefit of **improved fuel efficiency** as well as maximum reliability and an enhanced resale value.

A badly serviced engine can consume up to 10% more fuel than necessary.

### Avoid short journeys

To reduce the consumption and emission of polluting gases, the engine and the exhaust filtration systems should reach the optimum **service temperature**.

With the engine cold, fuel consumption is proportionally higher. The engine does not warm up and fuel consumption does not normalise until having driven approximately *four* kilometres. This is why we recommend avoiding short trips whenever possible.

### Maintain the correct tyre pressures

Bear in mind that keeping the tyres at an adequate pressure saves fuel. If the tyre pressure is just one bar too low, fuel consumption can increase by as much as 5%. Due to the greater rolling resistance, under-inflation also increases **tyre wear** and impairs handling.

The tyre pressures should always be checked when the tyres are *cold*.

Do not use **winter tyres** all year round as they increase fuel consumption by up to 10%.

### Avoid unnecessary weight

Every kilo of **extra weight** will put up the fuel consumption, so it is worth checking the luggage compartment occasionally to make sure that no unnecessary loads are being transported.

A roof rack is often left in place for the sake of convenience, even when it is no longer needed. At a speed of 100-120 km/h your vehicle will use about 12% more fuel as a result of the extra wind resistance caused by the roof rack even when it is not in use.

### Save electricity

The engine activates the alternator, which produces electricity. With the need for electricity, fuel consumption is also increased. Because of this, always turn off electrical components when you do not need them. Examples of components that use a lot of electricity are: the fan at high speeds, the rear window heating or the seat heaters\*.



### Note

- If your vehicle has *Start-Stop*, it is not recommended to disconnect this function.
- It is recommended to *close the windows* when driving at more than 60 km/h
- Do not drive with your foot resting *on the clutch pedal*, as the pressure can make the plate spin, more fuel will be used and it can burn the clutch plate lining, causing a serious fault.
- Do not hold the vehicle on a hill with the clutch, use the foot brake or hand brake, using the latter to start. The fuel consumption will be lower and you will prevent the clutch plate from being damaged.
- On descents, use the engine brake, changing to the gear that is more suitable for the slope. The fuel consumption will be lower and the brakes will not suffer.

## Environmental friendliness

---

Environmental protection is a top priority in the design, choice of materials and production of your new Seat.

### Design measures for economical recycling

- Joints and connections designed for easy dismantling
- Modular construction to facilitate dismantling
- Increased use of single-grade materials
- Plastic parts and elastomers are marked in accordance with ISO 1043, ISO 11469 and ISO 1629

### Choice of materials

- Nearly all materials used can be recycled
- Similar types of plastics grouped together for easy recycling
- Recycled materials used in manufacture
- Reduction of volatile compounds in plastics
- CFC-free refrigerant in air conditioner

**Compliance with prohibited materials regulation:** cadmium, lead, mercury, chrome VI.

### Manufacturing methods

- Use of recycled material for manufacturing plastic parts
- Solvent-free cavity sealing
- Solvent-free wax for protecting the vehicles in transit
- Solvent-free adhesives
- No CFCs used in production
- Surplus materials used extensively for energy conversion and building materials
- Overall water consumption reduced
- Heat recovery systems
- Use of water-soluble paints

## Driving abroad

---

### Observations

---

To drive abroad, the following must be taken into consideration:

- For vehicles fitted with a catalytic converter ensure that unleaded petrol is available for the journey. See the chapter "Refuelling". Automobile organisations will have information about service station networks selling unleaded fuel.
- In some countries, it is possible that your vehicle model is not sold, and therefore spare parts are not available or the Technical Services can only carry out limited repairs.

SEAT importers and distributors will gladly provide information about the technical preparations that you vehicle requires and also about necessary maintenance and repair possibilities. ■

### Adhesive strips for headlights

---

If you have to drive a right-hand drive vehicle in a left-hand drive country, or vice versa, the asymmetric dipped beam headlights will dazzle oncoming traffic.

To prevent dazzling, you must apply stickers to certain parts of the headlight lenses. Further information is available at your Technical Service.

In vehicles with adaptive headlights, the rotation system must previously be disconnected. To do this, please go to a specialised workshop. ■

## Trailer towing

### Trailer towing

#### Technical requirements

*The towing bracket must meet certain technical requirements.*

Your vehicle is intended mainly for transporting passengers and luggage. However, if suitably equipped, it can also be used to tow a trailer or caravan.

If your vehicle has been **factory**-supplied with a towing bracket, all of the necessary technical and legal aspects for trailing towing have been taking into account during manufacturing.

Your vehicle is fitted with a 13-pole socket for the electrical connection between the trailer and the vehicle. If the trailer has a **7-pole connector** you can use an adapter cable. This can be purchased at a Technical Service.

If a towing bracket is to be fitted after the vehicle is purchased, this must be done according to the instructions of the towing bracket manufacturer ⇒ page 214.

#### WARNING

If a towing bracket is retrofitted, the installation should be carried out by a specialised workshop.

- Particularly in high outdoor temperatures, it is not possible to drive up long steep gradients without a suitable cooling system. The engine would heat up.
- Incorrect installation can result in a safety risk!

#### Notes on towing

*There are a number of points which need to be checked before towing a trailer or caravan.*

- Observe the maximum permitted trailer weights ⇒ page 304.

#### Trailer weight

Never exceed the maximum permitted trailer weight.

If you do not load the trailer up to the maximum permitted trailer weight, you can then climb correspondingly steeper gradients.

The maximum trailer weights listed are only applicable for **altitudes** up to 1000 m above sea level. With increasing altitude the engine power and therefore the vehicle's climbing ability are impaired because of the reduced air density. The maximum trailer weight has to be reduced accordingly. The weight of the vehicle and trailer must be reduced by about 10% for every subsequent 1000 m (or part thereof). This figure refers to the combined weight of the (loaded) vehicle and (loaded) trailer.

The figures for the **drawbar load** that appear on the identification plate of the towing bracket are for certification purposes only. The correct figures for your specific model, which may be *lower* than these figures for the towing bracket, are given in the registration documents and on ⇒ page 297. Also refer to ⇒ page 304.

#### Distributing the load

Distribute loads in the trailer so that heavy objects are as near to the axle as possible. Loads carried in the trailer must be secured to prevent them moving. ▶

Where possible, operate the trailer with the maximum permitted **drawbar load** on the ball joint of the towing bracket, but do not exceed the specified limit.

#### Tyre pressure

Check the tyre pressures on your vehicle, and adjust for “full load” conditions (refer to the sticker listing the tyre pressures on the door pillar). It may also be necessary to adjust the tyre pressures on the trailer according to the recommendations of the trailer manufacturer.

#### Exterior mirrors

Check whether you can see enough of the road behind the trailer with the standard mirrors. If this is not the case you should have additional mirrors fitted. The two exterior mirrors should be fitted on folding arms. Adjust the mirrors to give sufficient rear vision.

#### Headlights

Before starting a journey, check the headlight beam settings with the trailer hitched up. If necessary, alter the height of the headlight beams by means of the headlight range control. See ⇒ page 121.

#### Power supply

When you remove the ignition key, the power supply to the trailer is interrupted.

#### Removable ball joint coupling

Vehicles with a factory-fitted towing bracket are equipped with a *removable* ball joint coupling. This is stored in the spare wheel well in the luggage compartment together with the necessary fitting instructions.



#### Note

If you frequently tow, we recommend you also have the vehicle serviced between services. ■

## Notes on towing

*Towing a trailer involves additional attention by the driver.*

#### Weight distribution

The weight distribution of a loaded trailer with an unladen vehicle is very unfavourable. However, if this cannot be avoided, drive extra slow to allow for the unbalanced weight distribution.

#### Speed

The stability of the vehicle and trailer is reduced with increasing speed. Therefore, it is advisable not to drive at the maximum permissible speed in unfavourable road, weather or wind conditions. This especially applies when driving downhill.

You should always reduce speed immediately if the trailer shows the slightest sign of **swaying**. Never try to stabilise the trailer by accelerating.

Anticipate hazards and brake in good time. If towing a trailer with an **inertia brake**, first brake *gently* and then harder. This will prevent brake tapping by the trailer wheels when they lock. Select a low gear in due course before going down a steep downhill. This enables you to use the engine braking to slow down the vehicle.

**Swaying and pitching** can be reduced by stabiliser aids. We recommend having stabiliser aids installed when towing trailers with a high trailer weight. They can be purchased and installed at a Technical Service.

#### Reheating

When climbing long hills in hot weather with the engine running fast in low gear, you should keep an eye on the coolant temperature gauge ⇒ page 62. Reduce speed immediately if the needle moves to the right end of the scale. If the temperature warning lamp  in the instrument panel should start flashing, stop the vehicle and let the engine cool down by running it *at idling speed* for a few minutes. ■

### Equipment and accessories

Before mounting equipment and accessories (e.g. bicycle rack) please observe the following notes.

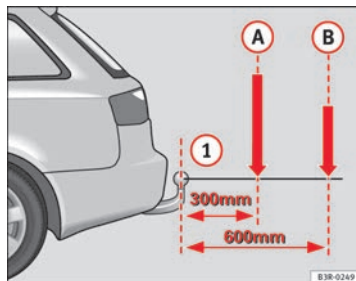

Fig. 164 Load distribution of equipment and accessories

The equipment/accessories mounted must not protrude more than 700 mm from the ball joint ①.

The total weight (mounted equipment plus the load) must not exceed 75 kg.

The maximum load depends on where the centre of gravity lies.

The maximum weight decreases as the distance between the centre of gravity and the ball joint ① increases.

The following limits apply:

If the distance is 300 mm, the total weight (incl. the equipment mounted) ① must not exceed 75 kg.

If the distance is 600 mm, the total weight (incl. the equipment mounted) ② must not exceed 35 kg.

Only bicycle racks for a maximum of three bicycles may be used.

#### Equipment and accessories mounted on the towing bracket

SEAT recommends that you only mount equipment (e.g. bicycle rack) on the towing bracket which has been officially approved. If you wish to attach other equipment please make sure that it has been approved by the manufacturer for use on the towing bracket. If you mount unsuitable equipment, this can cause damage to the towing bracket. In an extreme case, damage to the towing bracket could cause it to break ⇒ ⚠.

#### ⚠ WARNING

- If you wish to mount equipment which has not been approved by SEAT, please ensure that it is suitable for use on SEAT vehicles.
- Use of unsuitable equipment can result in severe damage to the towing bracket. The towing bracket could then break while pulling a trailer and cause an accident.
- Never use tools of any kind when fitting and removing the ball joint. This would damage the locking device, no longer guaranteeing the correct working order of the bracket. This could lead to an accident.

## Removable towing bracket

### Introduction

*Special care is required when fitting and removing the towing bracket.*

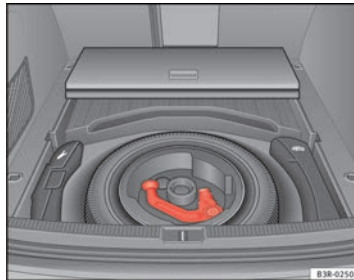

**Fig. 165** Luggage compartment: Spare wheel with towing bracket

The removable ball joint attachment for the towing bracket is stored under the floor panel in the luggage compartment.

- Vehicles with a spare wheel ⇒ Fig. 165.

The ball joint can be fitted and removed by hand.

#### Accessories mounted on the towing bracket

Please note that the ball joint attachment can be damaged by using unsuitable equipment that is mounted onto the towing bracket (e.g. bicycle rack). Due to the material construction, such damage to the towing bracket dramatically increases safety risks and in extreme cases could lead to breakage of the towing bracket while towing ⇒ ⚠.

Therefore, **before buying** such equipment, ensure that it is suitable for mounting onto the vehicle's towing bracket and that it is approved for this purpose. To prevent damage to the ball joint from unsuitable equipment, we recommend that equipment for the towing bracket be purchased through your SEAT Dealership. Also see ⇒ page 228.



#### WARNING

- **Only mount equipment on the towing bracket of your vehicle if you are certain it will not damage the bracket. Use of unsuitable equipment can result in severe damage to the towing bracket. The towing bracket could then break while pulling a trailer and cause an accident.**
- **Never use tools of any kind when fitting and removing the ball joint. This would damage the locking device, no longer guaranteeing the correct working order of the bracket. This could lead to an accident.**



#### Note

- Do not attempt to modify or repair the ball joint or other towing bracket components.
- Should you have any difficulties when using the towing bracket, or suspect that it is not fitted properly, contact a specialised workshop.
- Before setting off, always check that the ball joint is secured properly ⇒ page 212.
- Never disengage the ball joint with the caravan / trailer still hitched or with a bicycle rack or similar accessory still attached.
- It is advisable to remove the ball joint when you are not towing a trailer. Make sure that the cover piece is properly fitted on the mounting fixture on the vehicle.
- Remove the ball joint before washing the vehicle with pressurised steam equipment. Make sure the cover piece is fitted correctly onto the mounting fixture. ■

### Fitting the ball joint (step 1)

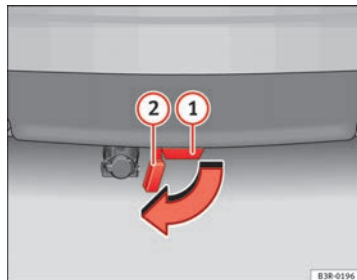

Fig. 166 Rear bumper:  
Open the cover piece

- Remove the cover piece ② ⇒ Fig. 166 on the mounting fixture ① below the bumper as far as it will go. The cover piece is held automatically in the open position.
- Make sure the mounting fixture is clean. If not, clean it ⇒ ⚠.

Cont ⇒ page 210, Fitting the ball joint (step 2).

#### ⚠ WARNING

It is important to keep the mounting fixture clean. Otherwise the ball joint may fail to engage safely and securely. This could lead to an accident.

### Fitting the ball joint (step 2)

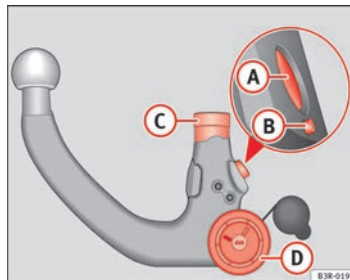

Fig. 167 Removable towing bracket: Ball joint

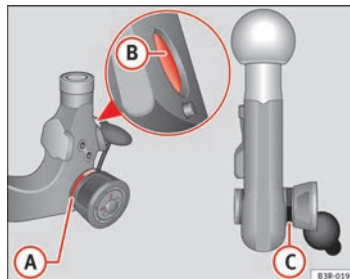

Fig. 168 Removable towing bracket: Ball joint

#### Make sure the ball joint is clean and undamaged

- Check the locking pin ①, release pin ②, shaft section ③ and knob ④ ⇒ Fig. 167 on the ball joint to make sure they are clean and undamaged. ▶

### The spring mechanism inside the ball joint must be in the ready position

- Check that the red marking **(A)** ⇒ Fig. 168 on the knob is inside the black zone marked on the ball joint.
- Check that the locking pin **(B)** is inside the holes in the shaft section of the ball joint.
- Check that the knob protrudes visibly from the ball joint, so that there is a clear gap **(C)** between the knob and the ball joint.

The ball joint can only be installed if the internal spring mechanism is in the **ready** position.

Cont ⇒ page 211, Fitting the ball joint (step 3).

### Fitting the ball joint (step 3)

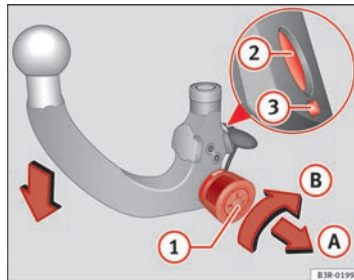

Fig. 169 Removable towing bracket: Setting the spring mechanism to the "ready" position

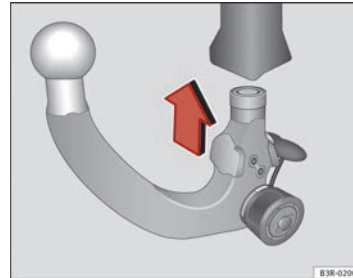

Fig. 170 Removable towing bracket: Inserting the ball joint

### Setting the spring mechanism to the ready position (if required)

- Insert the key **(1)** ⇒ Fig. 169 in the lock on the knob and turn it towards the red marking.
- Pull out the knob in direction **(A)**, hold and turn in direction **(B)** until the locking pin **(2)** engages and the release pin **(3)** moves out visibly ⇒ **Δ**.

### Inserting the ball joint

- With the spring mechanism in the ready position, insert the ball joint into the mounting fixture and push it upwards ⇒ Fig. 170 in the direction indicated (arrow) ⇒ **Δ**. It should lock into position automatically. You should now clearly hear it click into place.
- Lock the ball joint by turning the key to the green marking.
- Remove the key.

Cont ⇒ page 212, Fitting the ball joint (step 4).

### ⚠ WARNING

- If it is not possible to set the spring mechanism to the ready position as described above, do not use the ball joint. Please contact a specialised workshop.
- To avoid injury, keep your hands away from the knob or cover piece when inserting the ball joint in the mounting fixture. Otherwise, you could be injured.

## Fitting the ball joint (step 4)

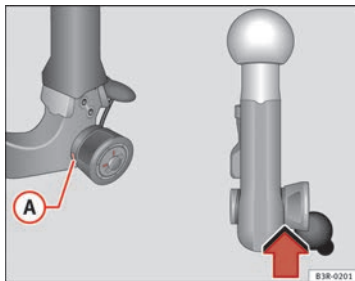

Fig. 171 Removable towing bracket: Safety check

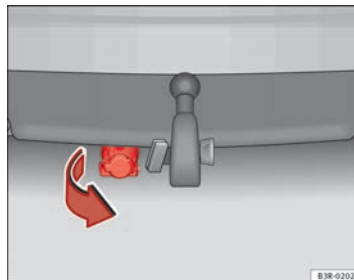

Fig. 172 Rear bumper: Pulling down the power socket

### Safety check

- Check that the green marking **A** ⇒ Fig. 171 on the knob is inside the black zone marked on the ball joint.
- Check that the knob is directly against the ball joint, so that there is no gap between the knob and the ball joint (arrow).
- Check that the ball joint is locked and the key is removed so that the knob cannot be pulled out ⇒ ⚠.
- Check that the ball joint fits tightly in the mounting fixture (try moving it about to check).

### Towing socket

- To plug in the electrical connection for the trailer, pull down the socket below the bumper ⇒ Fig. 172.

If the safety check is not satisfactory, the ball joint must be fitted again properly. ▶

**⚠ WARNING**

To avoid accidents, the ball joint must meet all the safety requirements listed in the safety check. The towing bracket must not be used if any one of these requirements is not met. If this is the case, you should contact a specialised workshop.

### Removing the ball joint

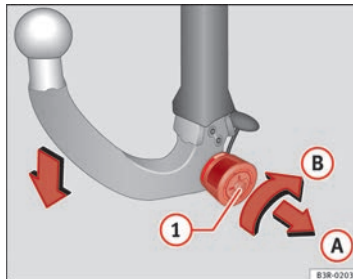

Fig. 173 Removable towing bracket: Removing the ball joint

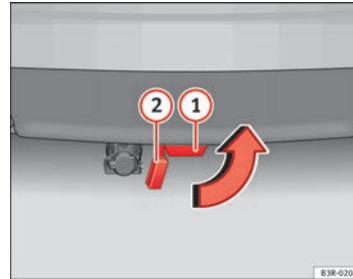

Fig. 174 Rear bumper: fitting the cover piece

- Insert the key in the lock ① ⇒ Fig. 173 on the knob.
- Unlock the ball joint by turning the key to the red marking.
- Take hold of the ball joint and pull out the knob in direction ①.
- Keep hold of the knob and turn it as far as it will go in direction ②.
- Release the knob. The spring mechanism will remain in the ready position ⇒ ⚠.
- Pull the ball joint down out of the mounting fixture ① ⇒ Fig. 174. The cover piece will cover the mounting fixture automatically ②.
- Put away the ball joint attachment under the floor panel in the luggage compartment.
- Move the socket back up to its original position. ▶

**⚠ WARNING**

- To avoid injury, keep your hands away from the locking pin and the release pin when releasing the locking mechanism.
- Make sure that the cover piece is properly engaged on the mounting fixture on the vehicle. Otherwise the ball joint may fail to engage securely if dirt accumulates in the mounting fixture.

### Fitting a towing bracket\*

*It is possible to fit a towing bracket to the rear of the vehicle.*

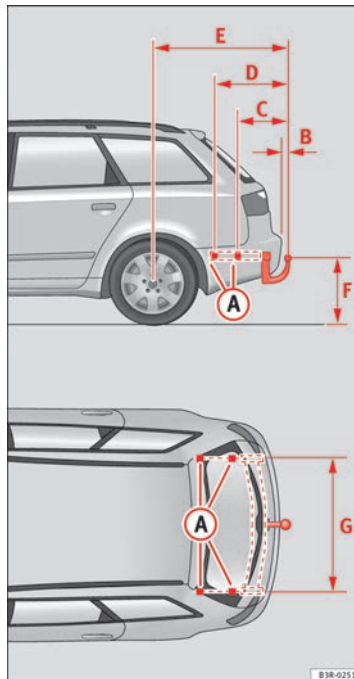

**Fig. 175 Attachment points for towing bracket**

If a towing bracket is to be fitted after the vehicle is purchased, this must be completed according to the instructions of the towing bracket manufacturer. ►

The attachment points for the towing bracket **(A)** are on the lower part of the vehicle.

The distance between the centre of the ball coupling and the ground should never be lower than the indicated value, even with a fully loaded vehicle and including the maximum drawbar load.

Elevation values for securing the towing bracket:

- (B)** 65 mm (minimum)
- (C)** 403
- (D)** 629 mm
- (E)** 1112 mm (vehicle with max. load)
- (F)** from 350 to 420 mm (vehicle with max. load)
- (G)** 1000 mm

#### Fitting a towing bracket

- Driving with a trailer involves an extra effort for the vehicle. Therefore, before fitting a towing bracket, please contact a Technical Service to check whether your cooling system needs modification.
- The legal requirements in your country must be observed (e.g. the fitting of a separate warning lamp).
- Certain vehicle components, e.g. the rear bumper, must be removed and reinstalled. The towing bracket securing bolts must be tightened using a torque wrench, and a power socket must be connected to the vehicle's electrical system. This requires specialised knowledge and tools.
- Figures in the illustration show the elevation value and the attachment points which must be considered if you are retrofitting a towing bracket.



#### WARNING

The towing brackets should be fitted at a specialised workshop.

- If the towing bracket is incorrectly installed, there is serious danger of accident.
- For your own safety, please observe the instructions provided by the manufacturer of the towing bracket.



#### CAUTION

- If the power socket is incorrectly installed, this could cause damage to the vehicle's electrical system.



#### Note

For the Sport finish, fitting a trailer bracket is not recommended due to the design of the bumpers. ■

## Vehicle maintenance and cleaning

### General notes

*Regular washing and care help maintain the value of your vehicle.*

#### Vehicle maintenance

Regular care and washing help to **maintain the value** of the vehicle. This may also be one of the requirements for acknowledging warranty claims in the event of bodywork corrosion or paint defects.

The best way to protect your vehicle against the harmful effects of the environment is through correct maintenance and *frequent* washing. The longer substances such as insect remains, bird droppings, resinous tree sap, road dirt, industrial deposits, tar, soot or road salt and other aggressive materials remain on the vehicle, the more damage they do to the paintwork. High temperatures (for instance in strong sunlight) further intensify the corrosive effect.

After winter, a period when salt is put on the roads, it is important to have the **underside** of the vehicle washed thoroughly.

#### Products for vehicle maintenance

Car care products are available in your Technical Services. Keep the product instructions until you have used them up.



#### WARNING

- Car care products can be toxic. Because of this, they must always be kept closed in their original container. Keep them out of the reach of children. Failure to comply could result in poisoning.
- Always read and observe the instructions and warnings on the package before using vehicle care products. Improper use could cause health problems or damage the vehicle. The use of certain products may produce noxious vapours; they should be used in well ventilated areas.
- Never use fuel, turpentine, engine oil, nail varnish remover or other volatile fluids. These are toxic and highly flammable. Risk of fire and explosion.
- Before washing your vehicle, or carrying out any maintenance, switch the engine off, apply the handbrake firmly and remove the key from the ignition.



#### CAUTION

Never attempt to remove dirt, mud or dust if the surface of the vehicle is dry. Never use a dry cloth or sponge for cleaning purposes. This could damage the paintwork or the windows of your vehicle. Soak dirt, mud or dust with plenty of water.



#### For the sake of the environment

- When purchasing products for your vehicle maintenance, select the ones which are not harmful to the environment.
- The waste from car care products should not be disposed of with ordinary household waste. Observe the disposal information on the package. ■

## Care of the vehicle exterior

### Automatic car wash tunnel

*The vehicle can normally be washed without problem in an automatic car wash.*

The vehicle paintwork is so durable that the vehicle can normally be washed without problems in an automatic car wash tunnel. However, the paintwork wear depends to a large extent on the kind of the car wash tunnel, the brushes used, its water filtering and the type of cleaning and preservative products.

Before going through a vehicle wash, be sure to take the usual precautions such as closing the windows and sunroof.

If the vehicle has special accessories such as spoilers or a roof rack or two-way radio aerial, etc., it is advisable to consult the car wash tunnel operator.

After washing, the **brakes** could take some time to respond as the brake discs and pads could be wet, or even frozen in winter. Dry the brakes by braking several times.

#### WARNING

Water, ice and salt on the brakes can reduce braking efficiency. Risk of accident.

### Washing by hand

#### Vehicle washing

- First soften the dirt and rinse it off with water.

- Clean your vehicle from top to bottom with a soft sponge, a glove or a brush. Use very light pressure.
- Rinse the sponge or glove often with clean water.
- Special car shampoo should only be used for very stubborn dirt.
- Leave the wheels, sill panels etc. until last, using a different sponge or glove.
- Rinse the vehicle thoroughly with water.
- Dry the vehicle surface gently with a chamois leather.
- In **cold temperature**, dry the rubber seals and their surfaces to prevent them from freezing. Apply silicone spray to the rubber seals.

#### After washing the vehicle

- After washing, avoid sudden and sharp braking. “Dry” the brakes by braking several times → page 201, Braking capacity and braking distance.

#### WARNING

- Wash your vehicle with the ignition switched off.
- Protect your hands and arms from cuts on sharp metal edges when cleaning the underbody, the inside of the wheel housings etc. Risk of injury.
- Water, ice and salt on the brakes can reduce braking efficiency. Risk of accident.

### ⚠ CAUTION

- Never remove dirt, mud or dust if the vehicle surface is dry. Never use a dry cloth or sponge for cleaning purposes. This could scratch the paintwork or glass on your vehicle.
- Washing the vehicle in low temperatures: when washing the vehicle with a hose, do not direct water into the lock cylinders or the gaps around the doors, rear lid, or sunroof. Risk of freezing.



### For the sake of the environment

To protect environment, the vehicle should be washed only in specially provided wash bays. This prevents toxic, oil-laden waste water entering the sewerage system. In some places, washing vehicles outside wash bays is prohibited.



### Note

Do not wash the vehicle in direct sunlight.

## Washing the vehicle with a high pressure cleaner

*Be particularly careful when using a high pressure cleaner!*

- Always observe the instructions for the high-pressure cleaner, particularly those concerning the **pressure** and the **spraying distance**.
- Increase the spraying distance for soft materials and painted bumpers.
- Do not use a high pressure cleaner to remove ice or snow from windows ⇒ page 219.
- Never use concentrated jet nozzles (“rotating jets”) ⇒ ⚠.

- After washing, avoid sudden and sharp braking. “Dry” the brakes by braking several times ⇒ page 201.



### WARNING

- **Never wash tyres with a concentrated jet (“rotating nozzle”). Even at large spraying distances and short cleaning times, visible and invisible damage can occur to the tyres. This may cause an accident.**
- **Water, ice and salt on the brakes can reduce braking efficiency. Risk of accident.**



### CAUTION

- Do not use water hotter than 60°C. This could damage the car.
- To avoid damage to the vehicle, keep a sufficient distance from sensitive materials such as flexible hoses, plastic, soundproofing material, etc. This is also important for bumpers painted in the colour of the bodywork. The closer the nozzle is to the surface, the greater the wear on the material.

## Vehicle paint maintenance

*Regular waxing protects the paintwork.*

You need to apply wax to your vehicle if water does not form small drops and run off the paintwork when it is *clean*.

Good quality *hard wax* products are available at your Technical Service.

Regular wax applications help to protect the paintwork from environmental contaminants ⇒ page 216. It is also effective in protecting against minor scratches.

Even if a **wax solution** is used regularly in the vehicle washing tunnel, it is advisable to protect the paint with a hard wax coating at least twice a year. ■

## Polishing the paintwork

*Polishing brings back gloss to the paintwork.*

Polishing is only necessary if the paint has lost its shine, and the gloss cannot be brought back by applying wax. Polishing products can be purchased in your Technical Service.

The vehicle must be waxed after polishing if the polish used does not contain wax compounds to seal the paint → page 218, Vehicle paint maintenance.



### CAUTION

To prevent damage to the paintwork:

- Do not use polishes and hard wax on painted parts with a matte finish or on plastic parts.
- Do not polish your vehicle in a sandy or dusty environment. ■

## Caring for plastic parts

*Solvents damage plastic parts.*

If normal washing fails to clean plastic parts, clean them with approved **solvent-free** plastic cleaning and care products.



### CAUTION

- The use of liquid air freshener directly over the air vents of the vehicle may damage the plastic parts if the liquid is accidentally spilled.
- Cleaning products which contain solvents will damage the material. ■

## Cleaning windows and exterior mirrors

### Cleaning windows

- Moisten the windows with commercially available, alcohol based glass cleaner.
- Dry the windows with a clean chamois leather or a lint-free cloth.

### Removing snow

- Use a small brush to remove snow from the windows and mirrors.

### Removing ice

- Use a de-icer spray.

Use a clean cloth or chamois leather to dry the windows. The chamois leathers used on painted surfaces are not suitable to clean windows because they are soiled with wax deposits which could smear the windows.

If possible, use a de-icing spray to remove ice. If you use an ice scraper, push it in one direction only without swinging it.

Use window cleaner or a silicone remover to clean rubber, oil, grease and silicone deposits off.

Wax deposits can be removed with a special cleaner available in your Technical Services. Wax deposits on the windscreen could cause the wiper blades to judder. Adding a window cleaner that dissolves wax to the windscreen washer fluid prevents wiper blades from juddering, but wax deposits are not removed. ▶

**CAUTION**

- Never use warm or hot water to remove snow and ice from windows and mirrors. This could cause the glass to crack!
- The heating element for the rear window is located on the inner side of the window. To prevent damage, do not put stickers over the heating elements on the inside of the window.

### Cleaning windscreen wiper blades

---

Clean wiper blades improve visibility.

1. Use a soft cloth to remove dust and dirt from the windscreen wiper blades.
2. Use window cleaner to clean the windscreen wiper blades. Use a sponge or a cloth to remove stubborn dirt.

### Rubber seals maintenance

---

*If rubber seals are well looked after, they will not freeze so quickly.*

1. Use a soft cloth to remove dust and dirt from the rubber seals.
2. Apply a specialist care product to the rubber seals.

The rubber strips on the doors, windows, bonnet and rear lid will remain pliable and last longer if they are treated with a suitable care product (for example silicone spray).

Caring for rubber seals will also prevent premature ageing and leaks. The doors will be easier to open. If rubber seals are well looked after, they will not freeze so quickly in winter. ■

### Door lock cylinders

---

*The door lock cylinders can freeze up in winter.*

To de-ice the lock cylinders you should only use spray with lubricating and anti-corrosive properties. ■

### Cleaning chrome parts

---

1. Clean chrome parts with a damp cloth.
2. Polish chrome parts with a soft, dry cloth.

If this does not provide satisfying results, use a specialist **chrome cleaning product**. Chrome cleaning products will remove stains from the surface.

**CAUTION**

To prevent scratching chrome surfaces:

- Never use an abrasive cleaning product on chrome.
- Do not clean or polish chrome parts in a sandy or dusty environment. ■

### Steel wheel rims

---

- Clean steel wheel rims regularly using a separate sponge. ▶

Use an industrial cleaner to remove brake dust. Any damage to the paint on steel wheel rims should be repaired before starting to rust.

### WARNING

- Never wash tyres with a cylindrical jet. Even at large spraying distances and short cleaning times, visible and invisible damage can occur to the tyres. This may cause an accident.
- Water, ice and salt on the brakes can reduce braking efficiency. Risk of accident. Directly after washing, avoid sudden and sharp braking. "Dry" the brakes by braking several times ⇒ page 201.

## Alloy wheel rims

### Every two weeks

- Wash salt and brake dust from alloy wheels.
- Use an acid free detergent to clean the wheel rims.

### Every three months

- Apply a hard wax compound to the wheels.

Alloy wheels require regular attention to preserve their appearance. If road salt and brake dust are not often removed, the aluminium finish will be impaired.

Always use an acid-free detergent for alloy wheel rims.

Car polish or other abrasive agents should not be used. If the protective coating is damaged, e.g. by flying stones, the damaged area should be repaired immediately.

### WARNING

- Never wash tyres with a cylindrical jet. Even at large spraying distances and short cleaning times, visible and invisible damage can occur to the tyres. This may cause an accident.
- Water, ice and salt on the brakes can reduce braking efficiency. Risk of accident. Directly after washing, avoid sudden and sharp braking. "Dry" the brakes by braking several times ⇒ page 201.

## Underbody protection

*The vehicle underbody is coated to protect it from chemical and mechanical damage.*

The protective coating can be damaged when driving. We recommend you to check the protective coating under the body and on the running gear, and reinstated if necessary, before and after the winter season.

We recommend you to go to your Technical Service to carry out repair work and additional anti-corrosion work.

### WARNING

**Do not apply underseal or anti-corrosion coatings to the exhaust pipes, catalytic converter or the heat shields on the exhaust system. The heat of the exhaust system or the engine could cause them to ignite. Risk of fire.**

## Cleaning the engine compartment

*Take special care when cleaning the engine compartment.*

### Anti-corrosion treatment

The engine compartment and the surface of the power unit are given anti-corrosion treatment at the factory.

Good corrosion protection is particularly important in winter when the vehicle is frequently driven on salted roads. To prevent the salt corroding the vehicle, the entire engine compartment should be thoroughly cleaned before and after winter.

**Your Technical Service** has got the necessary equipment to provide the correct cleaning and preserving products. For this reason, we recommend having this work performed by them.

The anti-corrosion protection is usually removed if the engine compartment is cleaned with grease removing solutions, or if you have the engine cleaned. On commissioning this work, ensure that all surfaces, seams, joints and components in the engine compartment are given anti-corrosion treatment.



### WARNING

- **When working in the engine compartment, always observe the safety warnings** ⇒ page 234.
- **Before opening the bonnet, switch the engine off, apply the hand-brake firmly and always remove the key from the ignition.**
- **Allow the engine to cool before you clean the engine compartment.**
- **Do not clean the vehicle underbody, wheel arches or wheel trims without protecting your hands and arms. You may cut yourself on sharp-edged metal parts. Failure to comply could result in injury.**



### WARNING (Continued)

- **Moisture, ice and salt on the brakes may affect braking efficiency. Risk of accident. Directly after washing, avoid sudden and sharp braking.**
- **Never touch the radiator fan. It is temperature-controlled and could start automatically, even when the key is removed from the ignition!**



### For the sake of the environment

Fuel, grease and oil deposits could be removed when the engine is washed. The polluted water must be cleaned in an oil separator. For this reason, engine washing should be carried out only by a specialised workshop or a petrol station.

## Vehicle interior maintenance

### Introduction

The dye used in many modern garments, for example dark jeans, is not always sufficiently colour-fast. Seat upholstery (material and leather), especially when light-coloured, may visibly discolour if the dye comes out of clothing (even when used correctly). This is not an upholstery defect but indicates that the dye in the item of clothing is not sufficiently colour-fast.

The longer stains or dirt remain on the vehicle surfaces, especially the fabrics covering the padded upholstery, the more difficult it becomes to clean and maintain them. If stains and dirt are left for a long time, it may be that they are impossible to remove.

**WARNING**

Vehicle care products may be toxic and hazardous. Using unsuitable car-care products or, using them in the wrong way, may cause accidents, serious injury, burns or intoxication.

- Keep your car-care products in their original containers.
- Read the instructions.
- Never keep car-care products in empty food containers, bottles or other similar containers, other people may confuse them.
- Keep all car-care products out of the reach of children.
- Some products may give off harmful vapours during use. Therefore, they should be used outdoors in well-ventilated places.
- Never use fuel, turpentine, engine oil, nail-varnish remover or any other volatile product for washing, maintenance or cleaning. These are toxic and highly flammable.

**WARNING**

Unsuitable maintenance and cleaning of vehicle components may impair proper operation of safety equipment and cause serious injury.

- Maintain and clean vehicle components according to the manufacturer's instructions.
- Only use approved or recommended cleaning products.

**CAUTION**

- Cleaning products which contain solvents have a corrosive effect and may damage the material irreparably.
- Stains and dirt containing aggressive substances or solvents attack the material and may damage it irreparably, even when they are cleaned quickly.

- Dirt and stains should not be allowed to dry and should be cleaned as quickly as possible.
- In the case of stubborn stains, take the vehicle to a specialised workshop to avoid damage.

**Treating your upholstery****Checklist**

To treat and maintain your seat upholstery, keep the following in mind ⇒:

- ✓ Before entering the vehicle, close any velcro fasteners that might snag on the upholstery or trim fabric. Any open velcro fasteners may damage the trim or upholstery fabrics.
- ✓ To prevent damage, avoid direct contact between sharp decorative objects and the upholstery and trim fabrics. Decorative objects include zips, rivets and rhinestones on clothing and belts.
- ✓ From time to time, clean the dust that gathers in the perforations, folds and seams so that the surfaces of the seats are not damaged by its abrasive effect.
- ✓ Make sure clothes are colour-fast to avoid them running and staining the upholstery. This is especially important if the upholstery is light in colour.

**CAUTION**

If you ignore this checklist, which is important for maintaining your seat upholstery, the fabric may be damaged or stained.

- Consult the checklist and carry out the operations it describes.

**Note**

SEAT recommends you take the vehicle to a specialised workshop to treat any stains on the upholstery caused by the discolouration of clothing.

## How to clean the upholstery, trim fabrics and Alcantara®

### Cleaning the fabric on heated seats and electrically adjustable seats or seats with airbag components

It is possible that there are important airbag components and electrical connections inside the driver seat, passenger seat and possibly the outer rear seats. If these seats and backrests are damaged, or are cleaned and are treated incorrectly, or if they get wet, the vehicle electric system may be destroyed and the airbag system damaged ⇒ ⚠.

Electric and heated seats contain components and electrical connections that may be damaged if the seats are cleaned or incorrectly treated ⇒ Ⓣ. Similarly, damage might be caused at other points in the vehicle's electric system.

For this reason, bear the following indications in mind for cleaning:

- Do not use high-pressure or steam cleaning equipment or cold aerosols.
- Do not use cream detergents or detergent-based solutions for delicate garments.
- Prevent the fabric from getting wet at all times.
- Only use cleaning products approved by SEAT.
- If in doubt, take the vehicle to a professional cleaning company.

### Cleaning the fabric on unheated seats, non-electrically adjustable seats and seats without airbag components

- Before using any cleaning products, consult and keep in mind the instructions of use, indications and warnings on the container.
- Use a vacuum cleaner (with the brush attachment) on the trim and seat fabrics, the Alcantara® upholstery of the seats and the carpet.
- Do not use high-pressure or steam cleaning equipment or cold aerosols.
- For general cleaning, use a soft sponge or an ordinary lint-free microfibre cloth ⇒ Ⓣ.
- Clean Alcantara® surfaces with a slightly damp cotton or woollen cloth, or a standard lint-free microfibre cloth ⇒ Ⓣ.

If the dirt on the trim and upholstery fabrics is only superficial, you can use a standard foam cleaner.

If the upholstery and trim are very dirty, before cleaning them we recommend you find out about the most suitable cleaning options from a professional cleaning company. If necessary, the cleaning should be carried out by a specialised company.

### Stain removal

When removing stains, it may be necessary to clean the whole surface and not just the stain itself. Especially if the surface has been dirtied through normal use. If you only clean the stained area, that part may then look lighter than the rest. If in doubt, take the vehicle to a professional cleaning company.



### WARNING

**If there is a fault in the airbag system, it is likely that the airbag will not deploy correctly, not deploy at all, or do so unexpectedly, which could cause serious or fatal injuries.**

- **Have the system checked immediately by a specialised workshop.**



### CAUTION

If the upholstery on electrically operated seats or seats with airbag components gets soaked, the vehicle's electric system and certain other components may be damaged.

- If the seat gets soaked, take the vehicle immediately to a specialised workshop to be dried and for the system components to be inspected.
- Do not use steam cleaning equipment as the dirt becomes more encrusted and fixed in the material.
- High-pressure cleaning equipment and cold aerosols may damage the upholstery. ▶

**CAUTION**

- Brushes should only be used to clean the carpet and floor mats! Other fabrics may be damaged if cleaned with a brush.
- If cream detergents or detergents for delicate garments are applied with a damp cloth or sponge, they may, for example, leave rings when dry because of the tensioactive components they contain. Generally, such rings are very difficult or almost impossible to remove.

**CAUTION**

- Do not let water soak into Alcantara® under any circumstances.
- Do not use leather cleaning products, solvents, wax polish, shoe cream, stain removers or similar products on Alcantara®.
- Never use brushes for cleaning damp material as they could damage the surface. ■

### Cleaning and maintenance of natural leather upholstery

Consult a professional cleaning workshop if you have any doubts on cleaning and maintaining the leather equipment in your car.

**Maintenance and treatment**

Nappa natural leather is delicate because it has no additional protective layer.

- After cleaning, regularly apply a conditioner with sun-screen and impregnating action. These products nourish the leather, soften it and make it more breathable, as well as re-hydrating it. They also provide it with a protective film.
- Clean the leather every two or three months and remove stains as they appear.
- Treat the leather regularly (about twice a year) with a suitable maintenance product.

- Apply as few cleaning and maintenance products as possible, always using a dry, lint-free cotton or woollen cloth. Do not apply cleaning and maintenance products directly to the leather.
- Remove recent ball-point pen and ink stains, lipstick, shoe cream and similar stains as soon as possible.
- Maintain the colour of the leather. To do this, use a special cream especially coloured for leather to achieve the same overall colour, if necessary.
- Afterwards, go over it with a soft cloth.

**Cleaning**

SEAT recommends using a slightly damp cotton or woollen cloth for general cleaning purposes.

Generally, the leather should never be soaked at any point, nor should water penetrate the seams.

**Before cleaning** the leather upholstery, bear in mind the following recommendations ⇒ page 224, Cleaning the fabric on heated seats and electrical adjustable seats or seats with airbag components.

**CAUTION**

- On no account use solvents, wax polish, shoe cream, stain removers or similar materials on leather.
- If the stain remains on the leather for long, it will soak in and be impossible to remove.
- In the event of spilt liquids, dry immediately with an absorbent cloth to prevent the liquid penetrating through the leather or seams.
- If the car is left standing in the sun for long periods, the leather should be protected against direct sunlight to prevent it from fading.

**Note**

The leather will usually change colour slightly with use. ■

### Cleaning synthetic leather upholstery

Before cleaning the synthetic leather upholstery, bear in mind the following recommendations ⇒ page 224. Cleaning the fabric on heated seats and electrically adjustable seats or seats with airbag components

Only use water and neutral cleaning products to clean synthetic leather upholstery.

#### CAUTION

Do not use solvents, floor wax, shoe cream, stain removers or similar products on synthetic leather. These will stiffen the material, causing it to crack prematurely.

### Plastic parts and dash panel cleaning

- Use a clean, damp cloth to clean plastic parts and the dash panel.
- If this does not provide satisfactory results, use a special **solvent-free** plastic cleaning product.

#### WARNING

**Never clean the dash panel and the airbag module surface with cleaners containing solvents. Solvents cause the surface to become porous. If the airbag triggered, plastic parts could become detached and cause injuries.**

#### CAUTION

Cleaning products which contain solvents will damage the material.

### Wooden trim cleaning\*

- Clean the wooden trim with a water-moistened clean cloth.
- If this does not provide satisfactory results, use a *gentle* soap solution.

#### CAUTION

Cleaning products which contain solvents will damage the material. ■

### Cleaning the radio and climate controls

To clean the radio and/or climate controls, use a soft damp cloth. For more resistant dirt, a neutral soap solution may be used. ■

### Seat belt cleaning

*A dirty belt may not work properly.*

Check all seat belts regularly and keep them clean.

#### Seat belt cleaning

- Pull the dirty seat belt right out and unroll it.
- Clean dirty seat belts with a *gentle* soap solution.
- Allow it to dry.
- Do not roll the seat belt up until it is dry. ▶

If large stains form on the belts, it will not retract correctly into the automatic belt retractor.

 **WARNING**

- Do not use chemical cleaning agents on the seat belts, as this can impair the strength of the webbing. Ensure that belts do not come into contact with corrosive fluids.
- Check the condition of the seat belts at regular intervals. If you notice that the belt webbing, fittings, retractor mechanism or buckle of any of the belts is damaged, the belt must be replaced by a specialised workshop.
- Do not attempt to repair a damaged seat belt yourself. The seat belts must not be removed or modified in any way.

 **CAUTION**

After cleaning, allow seat belts to dry completely before rolling them up. Otherwise, the belt retractors could become damaged. ■

## Accessories, replacement of parts and modifications

### Accessories and spare parts

*Always consult a SEAT dealership before purchasing accessories and parts.*

Your vehicle is designed to offer a high standard of active and passive safety.

Before purchasing accessories and parts, and before making technical changes to your vehicle, we recommend you to consult your Technical Service.

SEAT dealerships will be happy to provide you with the latest information about the use, legal requirements and recommendations from the manufacturer regarding accessories and parts.

We recommend you use only **SEAT Approved Accessories®** and **SEAT Approved Spare Parts®**. This way, SEAT can guarantee that the product in question is suitable, reliable and safe. SEAT Technical Services have the necessary experience and facilities to ensure that parts are correctly and professionally installed.

Despite a continuous observation of the market, SEAT is not able to assess the reliability, safety and suitability of those parts **SEAT has not approved**. For this reason, SEAT cannot assume responsibility for any non-genuine parts used, even if these parts have been approved by an official testing agency or are covered by an official approval certificate.

Any **equipment subsequently installed** which has a direct effect on the driver's control of the vehicle (e.g. cruise control system or electronically-controlled suspension) must be approved by SEAT and bear the **e** mark (the European Union's authorisation symbol).

If any **additional electrical components** are fitted which do not serve to control the vehicle itself (e.g. refrigerator box, laptop or ventilator fan), these must bear the **CE** mark (European Union manufacturer conformity declaration).



#### WARNING

**Accessories, for example telephone holders or cup holders, should never be fitted on the covers, or within the working range, of the airbags. Otherwise, there is a danger of injury if the airbag is triggered in an accident.**

### Technical modifications

*Modifications must always be carried out according to our specifications.*

Unauthorised modifications to the electronic components or software in the vehicle may cause malfunctions. Due to the way the electronic components are linked together in networks, other indirect systems may be affected by the faults. This can seriously impair safety, lead to excessive wear of components, and also invalidate your vehicle registration documents.

SEAT Technical Services cannot be held liable for any damage caused by modifications and/or work incorrectly performed.

For this reason, we recommend having all work performed by a SEAT Technical Service using **Genuine SEAT® Spare Parts**.

**⚠ WARNING**

Incorrectly performed modifications or other kind of work on your vehicle can lead to malfunctions and cause accidents.

## Mobile phones and two-way radios

First consult your Technical Service if you wish to use a mobile telephone or a two-way radio with a transmitting power output in excess of 10 watts. Here you will receive information concerning the technical possibilities for retrofitting this equipment.

Mobile telephones and two-way radios should be only fitted by a specialised workshop, for example a SEAT dealership.

**⚠ WARNING**

- Always concentrate primarily on driving. If you are distracted while driving you could have an accident.
- Never attach the telephone mountings to the surfaces covering the airbag units or within the range of the airbags. There is a high danger of injury if the airbag is triggered.

**i Note**

Please observe the operating instructions of your mobile telephone / two-way radio.

## Athermic windscreen\*



Fig. 176 Location of the electronic toll collection system

Vehicles with an athermic windscreen have an area without athermic treatment above the rear view mirror ⇒ Fig. 176. This area has been designed for the operating of electronic components of fitted devices (e.g. electronic toll collection system).

**i Note**

The customer should ensure that the electronic toll collection system is fitted in the correct area to make sure it works correctly.

## Checking and refilling levels

### Refuelling

The tank flap is released manually. The tank holds approximately 70 litres.



Fig. 177 Fuel tank flap with tank cap attached

The flap that covers the tank cap is unlocked and locked automatically by the central locking.

#### Unscrewing the tank cap

- Press the right side of the flap to open it.
- Unscrew the fuel tank cap anticlockwise.
- Hook the cap onto the support fitted to the open tank flap  
⇒ Fig. 177.

#### Closing the tank cap

- Screw the tank cap clockwise into the filler opening until you hear it click into position.
- Close the tank flap.

The tank flap is at the rear of the vehicle on the right.

If the automatic filler nozzle is operated correctly, it will switch itself off as soon as the tank is “full”. Never attempt to fill beyond this point, as this will fill the expansion chamber. Fuel may leak out if ambient conditions are warm.

The correct fuel grade for your vehicle is given on a sticker on the inside of the fuel tank flap. Here you will find further information on fuel.

#### Releasing the fuel tank flap manually\*

If the central locking system fails, the fuel tank flap can be opened manually as follows:

- Open the rear lid
- Remove the cover from the right side trim in the luggage compartment.
- Insert a hand and pull the locking device back
- Open the cap and take out the plug. ▶

**WARNING**

- Fuel is highly flammable and can cause serious burns and other injuries.
  - Never smoke or use an open flame when filling the fuel tank of the vehicle, or a spare fuel canister, with fuel. This is an explosion hazard.
  - Follow legal requirements for the use of spare fuel canisters.
  - For safety reasons we do not recommend carrying a spare fuel canister in the vehicle. The canister could be damaged in an accident and leak.
- If, in exceptional circumstances, you have to carry a spare fuel canister, please observe the following points:
  - Never fill the spare fuel canister inside the vehicle or on it. An electrostatic charge could build up during filling, causing the fuel fumes to ignite. This could cause an explosion. Always place the canister on the ground to fill it.
  - Insert the fuel nozzle into the mouth of the canister as far as possible.
  - If the spare fuel canister is made of metal, the filling nozzle must be in contact with the canister during filling. This helps prevent an electrostatic charge building up.
  - Never spill fuel in the vehicle or in the luggage compartment. Fuel vapours are explosive. Danger of death.

**CAUTION**

- Fuel spills should be removed from the paintwork immediately.
- Never run the tank completely dry. An irregular fuel supply could cause misfiring. As a result, unburnt fuel could enter the catalytic converter and cause damage.
- When filling the fuel tank after having run it completely dry on a vehicle with a **diesel engine** the ignition must be switched on for at least 30 seconds without starting the engine. When you then start the engine it may

take longer than normal (up to one minute) for the engine to start firing. This is due to the fact that the fuel system has to purge itself of air before starting.

**For the sake of the environment**

Do not try to put in more fuel after the automatic filler nozzle has switched off; this may cause the fuel to overflow if it becomes warm. ■

## Petrol

### Petrol types

*The recommended fuel types are listed on a sticker inside the fuel tank flap.*

Only **unleaded petrol conforming to standard DIN EN 228** may be used for vehicles with catalytic converters (EN = “European Standard”).

Fuel types are differentiated by the **octane rating**, e.g: 91, 95, 98 RON (RON = “Research Octane Number”, unit for determining the knock resistance of petrol). You may use petrol with a higher octane number than the one recommended for your engine. However, this has no advantage in terms of fuel consumption and engine power.

The correct fuel type for your vehicle is given in the technical table for the engine, in the Technical Data section. ►

**CAUTION**

- Petrol with standard EN 228 may be mixed with small quantities of ethanol. However, bioethanol fuels available at commercial establishments with reference E50 or E85, which contain a high percentage of ethanol, may **not** be used, as they will damage the fuel system.
- Even one tankful of leaded fuel would permanently impair the efficiency of the catalytic converter.
- High engine speed and full throttle can damage the engine when using petrol with an octane rating lower than the correct grade for the engine.

**For the sake of the environment**

Just one full tank of leaded fuel would seriously impair the efficiency of the catalytic converter.

**Petrol additives**

*Petrol additives improve the quality of the petrol.*

The quality of the petrol influences the performance, power and life of the engine. For this reason, you should use good quality petrol containing additives. These additives will help to prevent corrosion, keep the fuel system clean and prevent deposits from building up in the engine.

If good quality petrol with additives is not available or engine problems occur, the required additives must be added during refuelling.

**Diesel****Diesel\***

**Diesel fuel** must conform to DIN EN 590 (EN = “European Standard”). It must have a cetane number (CN) of at least 51. The cetane number indicates the ignition quality of the diesel fuel.

Notes on refuelling ⇒ page 230.

**Biodiesel\*****CAUTION**

- Your vehicle is **not** designed to use biodiesel fuel. **Never, under any circumstances** refuel with biodiesel. The use of biodiesel fuel could damage the engine and the fuel system. The addition of biodiesel to diesel fuel by the diesel manufacturer in accordance with standard EN 590 or DIN 51628 is authorised and will not cause damage to the engine or the fuel system.
- The diesel engine has been designed to be used exclusively with diesel fuel conforming to standard EN 590. **Never** refuel or use petrol, kerosene, fuel oil or any other type of fuel. If you accidentally fill up the vehicle with the wrong type of fuel, do not start the engine. Seek assistance from specialised personnel. The composition of these fuels may severely damage the fuel system and the engine.

## Winter driving

*Diesel can thicken in winter.*

### Winter-grade diesel

When using summer-grade diesel fuel, difficulties may be experienced at sub-zero temperatures because the fuel thickens due to wax separation. For this reason, winter-grade diesel fuel is available in some countries during the cold months. It can be used at temperatures as low as  $-22^{\circ}\text{C}$ .

In countries with different climatic conditions the diesel fuel generally sold has different temperature characteristics. Check with a Technical Service or filling stations in the country concerned regarding the type of diesel fuels available.

### Filter pre-heater

Your vehicle is fitted with a fuel filter glow plug system, making it well equipped for operation in winter. This ensures that the fuel system remains operational to approx.  $-24^{\circ}\text{C}$ , provided you use winter-grade diesel that is safe to  $-15^{\circ}\text{C}$ .

However, if the fuel has waxed to such an extent that the engine will not start at temperatures of under  $-24^{\circ}\text{C}$ , simply place the vehicle in a warm place for a while.



### CAUTION

Do not mix fuel additives (thinners or similar products) with diesel fuel.

## Bonnet

### Releasing the bonnet

*The bonnet is released from inside the vehicle.*

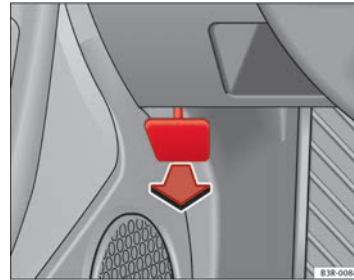

Fig. 178 Detail of footwell area on driver side: lever for unlocking the bonnet.

- To release the bonnet, pull the lever under the dash panel  
⇒ Fig. 178 in the direction indicated (arrow).

The bonnet springs out of its lock.

## Opening the bonnet

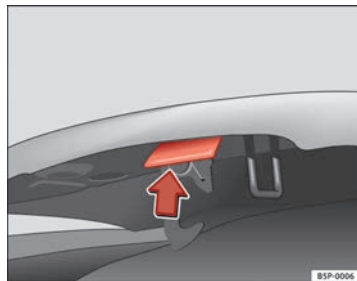

Fig. 179 Release catch under the bonnet

Before opening the bonnet make sure that the windscreen wiper arms are not lifted away from the glass. Otherwise the paint may be damaged.

- Lift the bonnet slightly ⇒ ⚠.
- Press the release catch under the bonnet upwards ⇒ Fig. 179. This will release the arrester hook under the bonnet.
- Open the bonnet.

The bonnet is held in position by a gas-filled strut.



### WARNING

Never open the bonnet if you see steam or drips of coolant being released from the engine compartment. Failure to comply could result in burns. Wait until no steam or coolant can be seen before opening the bonnet.

## Work in the engine compartment

Extra caution is necessary when working on components in the engine compartment.

Always be aware of the danger of injury and scalding as well as the risk of accident or even fire when working in the engine compartment (e.g. when checking and refilling fluids). Always observe the warnings listed below and follow all general safety precautions. The engine compartment of the vehicle is a potentially hazardous area ⇒ ⚠



### WARNING

- Switch the engine off.
- Remove the ignition key.
- Apply the handbrake firmly.
- If your vehicle is equipped with a manual gearbox, place the gear lever in neutral. If you are driving an automatic vehicle, place the selector lever in position P.
- Wait for the engine to cool down.
- Children should not be allowed to approach the engine compartment.
- Never spill liquids used for vehicle operation on the engine compartment, as these may catch fire (e.g. coolant).
- Take care not to cause short circuits in the electrical system, especially when working on the battery.
- Never touch the radiator fan while the engine is hot, as the fan could start up suddenly.
- Never open the expansion tank when the engine is hot. The cooling system is under pressure.
- Protect face, hands and arms from any hot steam or hot coolant fluid released by covering the cap with a large, thick rag when opening the expansion tank.

 **WARNING (Continued)**

- If any tests have to be performed with the engine running, there is an added safety risk from the rotating parts (e.g. drive belts, alternator, radiator fan, etc.) and from the high-voltage ignition system.
- Observe the following additional warnings if work on the fuel system or the electrical system is necessary:
  - Always disconnect the battery.
  - Do not smoke.
  - Never work near open flames.
  - Always keep an approved fire extinguisher immediately available.

 **CAUTION**

When topping up fluids, make sure the correct fluid is put into the correct filler opening. This can otherwise cause serious malfunctions or engine damage.

 **For the sake of the environment**

Inspect the ground underneath your vehicle regularly so that any leaks are detected at an early stage. If you find spots of oil or other fluids, have your vehicle inspected at the workshop.

- When the external temperature and level of humidity are high or when the engine stops, it is possible for water to drop from the air conditioning system evaporator potentially forming a small puddle on the ground. This is normal and does not indicate a leak.

 **Note**

On right-hand drive vehicles some of the reservoirs mentioned below are located on the other side of the engine compartment. ■

**Closing the bonnet**

- To close the bonnet, push it down until it overcomes the spring pressure.
- Let the bonnet engage in the locking part. *Do not force it* ⇒ .

 **WARNING**

- For safety reasons the bonnet must always be completely closed when the vehicle is moving. After closing it always check that it is properly secured. The bonnet must be flush with the adjacent body panels.
- Should you notice that the bonnet is not safely secured when the vehicle is moving, stop the vehicle immediately and close the bonnet. Failure to do so could result in an accident. ■

**Engine oil****General notes**

The engine is factory-filled with a special multi-grade oil that can be used all year round.

As the use of high quality oil is essential for the correct operation of the engine and its long useful life, when topping up or replacement is necessary use only those oils that conform to the requirements of the VW standards.

The specifications (VW standards) set out in the following page should appear on the container of the service oil; when the container displays the specific standards for petrol and diesel engines together, it means that the oil can be used for both types of engines. ►

We recommend that the oil change, indicated in the Maintenance Programme, be performed by a Technical Service or a specialised workshop.

The correct oil specifications for your engine are listed in ⇒ page 236, Oil properties.

#### Service intervals

Service intervals can be flexible (LongLife service) or fixed (dependent on time/distance travelled).

If the PR code that appears on the back of the “Maintenance Programme” booklet is PR QI6, this means that your vehicle has the LongLife service programmed. If it lists the codes QI1, QI2, QI3, QI4 or QI7, the interval service is dependent on time/distance travelled.

#### Flexible service intervals (LongLife\*)

Special oils and processes have been developed which, depending on the characteristics and individual driving profiles, allow to extend the oil change service (LongLife service intervals).

Because this oil is essential for extending the service intervals, it **must only** be used observing the following indications:

- Avoid mixing it with oil for fixed service intervals.
- Only in exceptional circumstances, if the engine oil level is too low ⇒ page 237 and LongLife oil is not available, it is permitted to top up (once) with oil for **fixed service intervals** (up to a maximum of 0.5 litres).

#### Fixed service intervals\*

If your vehicle does not have the “LongLife service interval” or it has been disabled (by request), you may use oils for **fixed service intervals**, which also appear in ⇒ page 236, Oil properties. In this case, your vehicle must be serviced after a fixed interval of 1 year / 15 000 km (whatever comes first) ⇒ Booklet Maintenance Programme.

- In exceptional circumstances, if the engine oil level is too low ⇒ page 237 and you cannot obtain the oil specified for your vehicle, you can put in a small quantity of oil conforming to the specification ACEA A2 or ACEA A3 (petrol engines) or ACEA B3 or ACEA B4 (diesel engines) (up to 0.5 l).

#### Vehicles with diesel particulate filter\*

All Exeo vehicles with a diesel engine have a diesel particulate filter and must **only** be filled with **VW 507 00** engine oil, which has a low level of soot formation. Using other types of oil will cause a higher soot concentration and reduce the life of the DPF. Therefore:

- Avoid mixing this oil with other engine oils.
- Only in exceptional circumstances, if the engine oil level is too low ⇒ page 237 and you cannot obtain the oil specified for your vehicle, you can use a small quantity of oil (once) conforming to the VW 506 00, VW 506 01, VW 505 00, VW 505 01 or ACEA B3 / ACEA B4 specification. (up to 0.5 l).

### Oil properties

Engine type	Specification
Petrol	VW 502 00 / VW 504 00
Diesel. Engines with particulate filter (DPF) <sup>a)</sup>	VW 507 00

<sup>a)</sup> Only use recommended oils, otherwise you may damage the engine.

Oils for LongLife service intervals*	
Engine type	Specification
Petrol	VW 504 00
Diesel	VW 507 00

### Engine oil additives

No type of additive should be mixed with the engine oil. The deterioration caused by these additives is not covered by the warranty.



#### Note

Before a long trip, we recommend finding an engine oil that conforms to the corresponding VW specifications and keeping it in the vehicle. This way, the correct engine oil will always be available for a top-up if needed.

## Checking the oil level

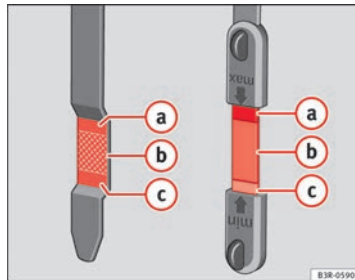

Fig. 180 Markings on oil dipstick

### Checking oil level

- Park the vehicle in a horizontal position.
- Briefly run the engine at idle speed until the service temperature is reached and stop.
- Wait two minutes.

- Pull out the dipstick. Wipe the dipstick with a clean cloth and insert it again, pushing it in as far as it will go.
- Then pull it out once more and check the oil level ⇒ Fig. 180. If the oil level is too low, add more engine oil ⇒ page 238.

#### Oil level in area (a)

- Do *not* add oil ⇒ ⑩ in Topping up the engine oil ↗ on page 238.

#### Oil level in area (b)

- You **can** add oil, but keep the level in this zone.

#### Oil level in area (c)

- Oil **must** be added. **Afterwards**, the oil level should be in the lined area (B).

Depending on how you drive and the conditions in which the vehicle is used, oil consumption can be up to 0.5 l/1000 km. Oil consumption is likely to be higher for the first 5000 km. Therefore, the engine oil level must be checked at regular intervals, preferably when filling the tank and before a journey.

### Topping up the engine oil



**Fig. 181** In the engine compartment: Engine oil filler cap

- Unscrew cap  from oil filler opening ⇒ Fig. 248.
- Carefully put in the specified grade of oil ⇒ page 236, adding 0.5 litres at a time.
- After two minutes, check the oil level once again ⇒ page 237.
- Where necessary, add more engine oil.
- Replace the oil filler cap carefully and push the dipstick all the way in.



#### WARNING

- When refilling with oil, make sure no oil falls onto hot engine parts. Failure to comply could result in fire.
- Wash your skin thoroughly if it comes into contact with engine oil.



#### CAUTION

- The oil level must never be above area . This could damage the catalytic converter or the engine. Contact a specialised workshop to drain the engine oil if necessary.
- No additives should be used with engine oil. Any damage caused by the use of such additives would not be covered by the factory warranty.



#### For the sake of the environment

- Oil must not be disposed of in the drain or on the ground.
- Always observe legal requirements when disposing of empty oil canisters. ■

## Cooling system

### Engine coolant specifications

The engine cooling system is supplied from the factory with a specially treated mixture of water and, at least, 40 % of the additive **G 13** (TLW 774 J). The engine coolant additive is recognisable by its purple colour. This mixture of water and additive gives the necessary frost protection down to -25°C (-13°F) and protects the light alloy parts of the cooling system against corrosion. It also prevents scaling and considerably raises the boiling point of the coolant.

To protect the engine cooling system, the percentage of additive must *always* be at least 40 %, even in warm climates where anti-freeze protection is not required.

If greater frost protection is required in very cold climates, the proportion of additive can be increased. However, the percentage of additive should not exceed 60 %, as this would reduce the frost protection and, in turn, decrease the cooling capacity. ▶

When the coolant is topped up, use a mixture of **distilled water** and, at least, 40 % of the G 13 or G 12 plus-plus (TL-VW 774 G) additive (both are purple) to obtain an optimum anticorrosion protection ⇒ ④. The mixture of G 13 with G 12 plus (TL-VW 774 F), G 12 (red) or G 11 (green-blue) engine coolants will significantly reduce the anticorrosion protection and should, therefore be avoided ⇒ ④.

### WARNING

If there is not enough anti-freeze in the coolant system, the engine may fail leading to serious damage.

- Please make sure that the percentage of additive is correct with respect to the lowest expected ambient temperature in the zone in which the vehicle is to be used.
- When the outside temperature is very low, the coolant could freeze and the vehicle would be immobilised. In this case, the heating would not work either and inadequately dressed passengers could die of cold.

### CAUTION

The original additives should never be mixed with coolants which are not approved by SEAT. Otherwise, you run the risk of causing severe damage to the engine and the engine cooling system.

- If the fluid in the expansion tank is not purple but is, for example, brown, this indicates that the G 13 additive has been mixed with an inadequate coolant. The coolant must be changed as soon as possible if this is the case! This could result in serious faults and engine damage.

### For the sake of the environment

Coolants and additives can contaminate the environment. If any fluids are spilled, they should be collected and correctly disposed of, with respect to the environment.

## Checking the coolant level

*The coolant level can be checked visually.*

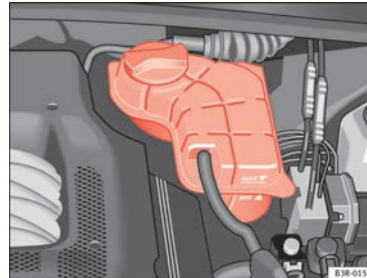

**Fig. 182** Engine compartment: Coolant fluid deposit

- Switch the ignition off.
- Check the coolant level on coolant fluid expansion tank ⇒ Fig. 182. When the engine is cold, it should be between the “min” and “max” marks. When the engine is hot, it may be slightly above the “max” mark.

Its location is shown in the corresponding general overview of the engine compartment.

The coolant level should be checked with the engine switched off.

The coolant level is monitored by a warning lamp on the instrument panel display ⇒ page 81. However, we recommend that it should be checked occasionally.

**Coolant fluid loss**

Any loss of coolant fluid normally indicates a **leak** in the cooling system. In this case the cooling system should be inspected by a specialised workshop without delay. It is not sufficient merely to top up the coolant fluid.

If there are **no leaks** in the system, a loss of coolant fluid can only occur if the coolant boils and is forced out of the system as a result of overheating.

**CAUTION**

Radiator sealants must not be added to the coolant fluid. Such additives could seriously impair the function of the cooling system. ■

**Topping up the coolant fluid**

*Be careful when topping up with coolant fluid.*

- Switch the engine off.
- Wait for the engine to cool down.
- Cover the cap on the expansion tank ⇒ Fig. 182 with a cloth, and **carefully** unscrew the cap anticlockwise ⇒ ⚠.
- Add coolant fluid.
- Screw on the cap *tightly*.

Make sure that the coolant fluid meets the required specifications ⇒ page 238. Do not use a different type of antifreeze if G12++antifreeze is not available. In this case, use only water and bring the antifreeze concentration back up to the correct level as soon as possible.

Always top up with *new* coolant fluid.

Do not fill above the “max” mark. Excess coolant fluid is forced out of the system through the valve in the filler cap when the engine gets hot.

If a lot of coolant fluid has been lost, wait for the engine to *cool down* before putting in cold coolant. Failure to do so could result in serious engine damage.

**WARNING**

- **The cooling system is under pressure. Do not unscrew the cap on the expansion tank when the engine is hot. Failure to comply could result in burns.**
- **The antifreeze and coolant fluid can be a health hazard. Therefore, the antifreeze should be stored in the original container in a safe place out of reach of children. Failure to comply could result in poisoning.**

**For the sake of the environment**

Drained off coolant should not be used again. Drain off the used coolant into a suitable container and dispose of it in the proper manner (observe environmental regulations). ■

**Radiator fan**

*The radiator fan can start running spontaneously.*

The auxiliary fan can continue to run for as long as 10 minutes after stopping the engine, even after the ignition is switched off. It may also start running suddenly ⇒ ⚠ after some while if

- Stored heat raises the coolant temperature, or
- The hot engine compartment is additionally heated up by the sun. ▶

**! WARNING**

When working in the engine compartment be aware that the radiator fan may start running suddenly, leading to the risk of injury.

## Washer fluid and windscreen wiper blades

### Windscreen washer system

Plain water is not sufficient for the windscreen washer system.



Fig. 183 In the engine compartment: Cap of windscreen washer fluid reservoir.

The container for the windscreen washer contains the cleaning fluid for the windscreen and the headlight washer system\*. The container is located in the engine compartment (front left). The filler cap is marked with the symbol  => Fig. 183.

The **capacity** of the container is listed in => page 304.

Plain water on its own is not enough to clean the glass properly. It is therefore advisable to add a suitable washer fluid additive (with wax solvent) to the water. A washer fluid with freeze-resistant additive should be used in winter.

**! CAUTION**

- Never put radiator antifreeze or other additives into the windscreen washer fluid.
- Never use washer fluid which contains paint thinners or solvents as it can damage the paintwork.

### Changing windscreen wiper blades

*If the windscreen wiper blades are in perfect condition, you will benefit from an improved visibility. Damaged wiper blades should be replaced immediately.*

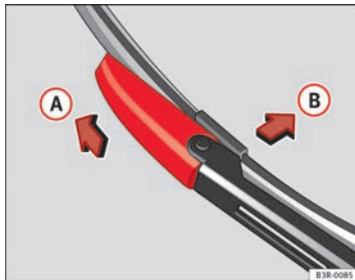

Fig. 184 Removing the wiper blade

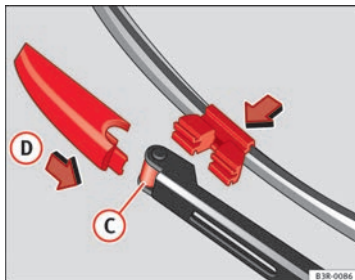

Fig. 185 Fitting the wiper blade

#### Removing the wiper blade

- Lift the wiper arm away from the windscreen.
- Slide the retainer catch on the wiper blade in the direction indicated ⇒ Fig. 184 (A). Hold onto the wiper blade at the same time.
- Pull the wiper blade (B) out of its mounting on the wiper arm.

#### Fitting the wiper blade

- Slide back the retainer catch on the new wiper blade. The mounting on the wiper blade should now be visible.
- Fit the new wiper blade into the mounting on the wiper arm ⇒ Fig. 185 (C).
- Slide the retainer catch on the wiper blade in direction (D) so that it clicks into place on the wiper arm.
- Fold the wiper arm back down onto the glass.

If the **windscreen wipers smear**, they should be replaced if they are damaged, or cleaned if they are soiled.

If this does not produce the desired results, the setting angle of the windscreen wiper arms might be incorrect. They should be checked by a specialised workshop and corrected if necessary. ▶

**⚠ WARNING**

Do not drive unless you have good visibility through all windows!

- The ignition must not be switched on while the front wiper arms are in a raised position. The wipers would return to their park position and damage the paintwork on the bonnet.
- To prevent smearing on the windscreen, the wiper blades should be cleaned regularly using a window cleaner solution. If the wiper blades are very dirty (e.g. insects etc.), they should be cleaned using a sponge or cloth. Failure to do so could result in an accident.
- For safety reasons, the wiper blades should be changed once or twice a year.



**CAUTION**

- Damaged or dirty windscreen wipers could scratch the windscreen.
- Never use fuel, nail varnish remover, paint thinner or similar products to clean the windows. This could damage the windscreen wiper blades.
- Never move the windscreen wiper or windscreen wiper arm manually. This could cause damage.
- Do not pull the windscreen wipers forward unless they are in the service position. Otherwise the bonnet could be damaged.

### Changing the rear wiper blade

*A good rear wiper blade is essential for clear rear vision. Damaged wiper blades should be replaced immediately.*

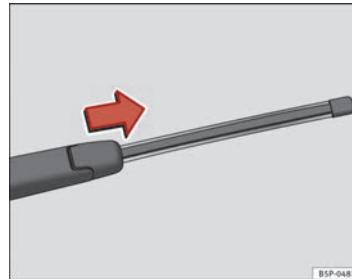

**Fig. 186** Removing rear window wiper blade

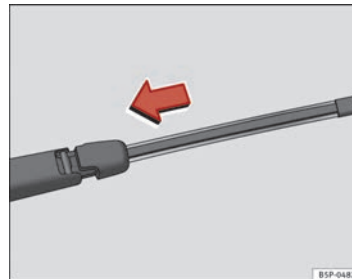

**Fig. 187** Fitting the rear window wiper blade ▶

### Removing the wiper blade

- Lift the wiper arm away from the glass ⇒ Fig. 186
- Slide the blade adapter in the direction of the arrow and remove the blade ⇒ Fig. 186.

### Fitting the wiper blade

- With one hand, hold the top end of the wiper arm.
- Place the blade as shown in the ⇒ Fig. 187 and slide the adapter along until it engages.

Check the condition of the wiper blade regularly. Change as required.

If the **windscreen wiper scrapes**, it should be replaced if damaged, or cleaned if soiled.

If this is not sufficient, refer to a specialised workshop.



#### WARNING

**Do not drive unless you have good visibility through all windows!**

- Clean the windscreen wiper blades and all windows regularly.
- The wiper blades should be changed once or twice a year.



#### CAUTION

- A damaged or dirty window wiper could scratch the rear window.
- Never use fuel, nail varnish remover, paint thinner or similar products to clean the window.
- Never move the windscreen wiper by hand. This could cause damage. ■

## Brake fluid

### Checking the brake fluid level

*The brake fluid level can be checked visually.*

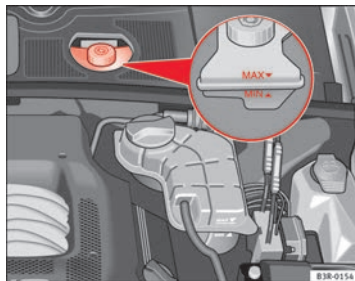

**Fig. 188** Engine compartment: markings on brake fluid reservoir

The brake fluid level must be between the “Min” and “Max” ⇒ Fig. 188 markings.

The fluid level may drop *slightly* after a period of time due to the automatic compensation for brake pad wear. This is quite normal.

However, if the level goes down noticeably in a *short* time, or drops below the “Min” mark, there may be a leak in the brake system. If the fluid level in the reservoir is too low, this will be indicated by the brake warning lamp ⇒ page 73 and ⇒ page 80. If this should happen, **take the vehicle to a specialised workshop immediately** and have the brake system inspected. ■

## Topping up and changing the brake fluid

*It is best to have the brake fluid changed by a professional.*

Brake fluid absorbs moisture. Therefore, in the course of time it will absorb water from the air. If the water content in the brake fluid is too high, the brake system could corrode. In addition, the boiling point of the brake fluid will be considerably reduced. This could adversely affect the braking ability in certain circumstances.

For this reason the brake fluid must be changed periodically.

Your vehicle's Service Plan will tell you when the brake fluid has to be renewed.

We recommend you have the brake fluid changed as part of a regular Inspection Service at a Technical Service. They are familiar with the procedure and have the necessary special tools and spare parts as well as the proper facilities for disposing of the old fluid.

Be sure to always use the correct brake fluid. Only use brake fluid that expressly meets VW 501 14 standards.

You can buy VW 501 14 standard brake fluid in a SEAT dealership or SEAT Official Service. If none is available, use only high quality brake fluid that meets DIN ISO 4925 CLASS 4 standards, or USA Standards FMVSS 116 DOT 4.

Using any other kind of brake fluid or one that is not of a high quality may affect operation of the brake system and reduce its effectiveness. Never use a brake fluid if the container does not state that it complies with VW 501 14, DIN ISO 4925 CLASS 4 standards, or USA standards FMVSS 116 DOT 4.



### WARNING

- Brake fluid must always be kept closed in its original container. Keep out of the reach of children. Failure to comply could result in poisoning.
- If the brake fluid is left in the system for too long and the brakes are subjected to heavy use, vapour bubbles may form in the brake system. This would seriously affect the efficiency of the brakes and the safety of the vehicle, leading to the risk of accident.



### CAUTION

Please note that brake fluid will attack the paintwork on contact.



### For the sake of the environment

The brake pads and fluid must be collected and disposed of according to the applicable regulations. The SEAT Technical Service network has the necessary equipment and qualified personnel for collecting and disposing of this waste material.

## Vehicle battery

### General notes

*All work on batteries requires specialist knowledge.*

The battery is virtually maintenance-free and is checked in the Inspection Services.

We recommend replacing the battery after 5 years. ▶

### Disconnecting the battery

If the battery is disconnected, some of the vehicle's functions will become inoperative (e.g. electric windows). These functions will require resetting after the battery is reconnected. For this reason, the battery should only be disconnected from the vehicle's electrical system when absolutely necessary.

### Long periods of non-use

The battery will gradually lose its charge because certain electrical equipment continues to draw current even when the ignition is off. If you park the vehicle for long periods of time in **winter** you should take the battery out of the vehicle and store it in a place protected from frost. This way it will not freeze and become damaged. At **warm** outside temperatures it is sufficient to disconnect the negative terminal of the battery. Even when the battery is not connected you should charge it from time to time.

### Winter operation

The battery is drained more in cold weather, which means that the starting power is reduced. For this reason, have the battery checked and charged if necessary before the start of winter.

### Replacing the battery

A replacement battery **must** have the same capacity, voltage and current rating. It must also have the same dimensions as the original, factory-fitted battery and have sealed caps. The SEAT batteries which have been specially developed fulfil the maintenance, performance and safety specifications for your vehicle.

We recommend you use maintenance-free batteries.



### WARNING

- **All work on batteries requires specialist knowledge. If work is required on the battery, this should be performed by a Technical Service or specialised workshop. Danger of caustic burns and explosion!**
- **The battery must not be opened. Never try to change the battery's liquid level. Explosive gas is released from the battery that could cause an explosion.**



### CAUTION

- The battery holder and clamps must always be correctly secured.
- Before starting any work on the battery, always observe the **warnings** listed under ⇒



### For the sake of the environment

✘ Batteries contain toxic substances including sulphuric acid and lead. Therefore, they must be disposed of in line with environmental regulations and must not be disposed of with ordinary household waste. Make sure disconnected batteries cannot tip over. Sulphuric acid could be spilt! ■

### Important safety warnings for handling a vehicle battery

The battery is located at the back of the engine compartment ⇒ page 304.



Wear eye protection



Battery acid is very corrosive and caustic. Wear protective gloves and eye protection!



Fires, sparks, open flames and smoking are prohibited! ▶



A highly explosive mixture of gases is released when the battery is under charge.



Keep children away from acid and batteries!



### WARNING

Always be aware of the danger of injury and chemical burns as well as the risk of accident or fire when working on the battery and the electrical system:

- Wear eye protection. Protect your eyes, skin and clothing from acid and particles containing lead.
- Battery acid is very corrosive and caustic. Wear protective gloves and eye protection. Do not tilt the batteries. This could spill acid through the vents. Rinse battery acid from eyes immediately for several minutes with clear water. Then seek medical care immediately. Neutralise any acid splashes on the skin or clothing with a soapy solution, and rinse off with plenty of water. If acid is swallowed by mistake, consult a doctor immediately.
- Fires, sparks, open flames and smoking are prohibited. When handling cables and electrical equipment, avoid causing sparks and electrostatic charge. Never short the battery terminals. High-energy sparks can cause injury.
- A highly explosive mixture of gases is released when the battery is under charge. The batteries should be charged in a well-ventilated room only.
- Keep children away from acid and batteries.
- Before working on the electrical system, you must switch off the engine, the ignition and all consumers. The negative cable on the battery must be disconnected. When a light bulb is changed, you need only switch off the light.



### WARNING (Continued)

- Deactivate the anti-theft alarm by unlocking the vehicle before you disconnect the battery! The alarm will otherwise be triggered.
- When disconnecting the battery from the vehicle electrical system, disconnect first the negative cable and then the positive cable.
- Switch off all electrical consumers before reconnecting the battery. Reconnect first the positive cable and then the negative cable. Never reverse the polarity of the connections. This could cause an electrical fire.
- Never charge a frozen battery, or one which has thawed. This could result in explosions and chemical burns. Always replace a battery which has frozen. A flat battery can also freeze at temperatures close to 0°C.
- Ensure that the vent hose is always connected to the battery.
- Never use a defective battery. This could cause an explosion. Replace a damaged battery immediately.



### CAUTION

- Never disconnect the battery if the ignition is switched on or if the engine is running. This could damage the electrical system or electronic components.
- Do not expose the battery to direct sunlight over a long period of time, as the intense ultraviolet radiation can damage the battery housing.
- If the vehicle is left standing in cold conditions for a long period, protect the battery from freezing. If it freezes it will be damaged.

## Charging the battery

*A fully-charged battery is important for reliable starting.*

- Note the warnings ⇒ in Important safety warnings for handling a vehicle battery on page 247 and ⇒ .

- Switch off the ignition and all electrical equipment.
- Only if fast-charging: both battery cables must be disconnected (first the negative cable, then the positive cable).
- Connect the charger cables to the battery terminals, noting the colour code (red = positive; black or brown = negative).
- Now connect the battery charger to the power socket and switch on.
- After charging the battery: switch off the battery charger and disconnect the power point cable.
- Finally disconnect the charger cables from the battery.
- If necessary, reconnect both battery cables to the battery (first the positive cable, then the negative cable).

When charging with a *low* current (for instance with a **small battery charger**) the battery does not normally have to be disconnected. However, both battery cables must be disconnected before **fast-charging** the battery with a *high* current. However, always follow the instructions given by the manufacturer of the battery charger.

The *fast-charging* procedure for a battery is **dangerous** ⇒ ⚠ in Important safety warnings for handling a vehicle battery on page 247, as it requires a special charger and the corresponding level of knowledge. We therefore recommend that this work should only be performed by a specialised workshop.

A flat battery can **freeze** at temperatures of around 0°C. The battery must be defrosted before charging ⇒ ⚠. It is advisable to replace the battery if it has frozen, because the ice can crack the battery casing and allow the battery acid to escape.

The battery caps should not be opened while the battery is being charged.

**WARNING**

**Never charge a frozen battery. Failure to comply could result in an explosion.**

## Wheels and tyres

### Wheels

#### General notes

##### Avoiding damage

- If you have to drive over a kerb or similar obstacle, drive very slowly and at a right angle.
- Keep grease, oil and fuel off the tyres.
- Inspect the tyres regularly for damage (cuts, cracks or blisters, etc.). Remove any foreign objects embedded in the treads.

##### Storing tyres

- When you remove the tyres, mark them in order to maintain the same direction of rotation when they are installed again.
- When removed, the wheels and/or tyres should be stored in a cool, dry and preferably dark location.
- Store tyres in a vertical position if they are not fitted on wheel rims.

##### New tyres

New tyres have to be run in.

The tread depth of new tyres may vary, according to the type and make of tyre and the tread pattern.

##### Concealed damage

Damage to tyres and rims is often not readily visible. If you notice unusual vibrations or the vehicle pulling to one side, this may indicate that one of the tyres is damaged. The tyres should be checked immediately by a Technical Service.

##### Tyres with directional tread pattern

An arrow on the tyre sidewall indicates the direction of rotation on tyres with directional tread. Always observe the direction of rotation indicated when fitting the wheel. This guarantees optimum grip and helps to avoid aquaplaning, excessive noise and wear.



#### WARNING

- **New tyres do not have maximum grip during the first 500 km. Drive particularly carefully to avoid possible accidents.**
- **Never drive with damaged tyres. This may cause an accident.**
- **If you notice unusual vibrations or if the vehicle pulls to one side when driving, stop the vehicle immediately and check the tyres for damage.**

#### Checking tyre pressure

*The correct tyre pressure can be seen on the sticker on the inside of the tank flap.*

1. Read the required tyre inflation pressure from the sticker. The values refer to Summer tyres. For Winter tyres, you must add 0.2 bar to the values given on the sticker. ▶

2. The tyre pressures should only be checked when the tyres are cold. The slightly raised pressures of warm tyres must not be reduced.
3. Adjust the tyre pressure to the load you are carrying.

#### Tyre pressure

The correct tyre pressure is especially important at high speeds. The pressure should therefore be checked at least once a month and before starting a journey.

The sticker with the tyre pressure values can be found on the inside of the tank flap. The tyre pressure values given are for cold tyres. Do not reduce the slightly raised pressures of warm tyres → ⚠.

#### WARNING

- Check the tyre pressure at least once per month. Checking the tyre pressure is very important. If the tyre pressure is too high or too low, there is an increased danger of accidents - particularly at high speeds.
- A tyre can easily burst if the pressure is too low, causing an accident!
- At continuously high speeds, a tyre with insufficient pressure flexes more. In this way it becomes too hot, and this can cause tread separation and tyre blow-out. Always observe the recommended tyre pressures.
- If the tyre pressure is too low or too high, the tyres will wear prematurely and the vehicle will not handle well. Risk of accident!



#### For the sake of the environment

Under-inflated tyres will increase fuel consumption.

#### Tyre pressure monitoring\*

*The tyre pressure monitoring system constantly checks the pressure of the tyres.*

The system warns the driver in the event of a loss of pressure by means of symbols and messages in the instrument panel display.

Note that tyre pressure also depends on tyre temperature. Tyre pressure increases about 0.1 bar for each 10°C in tyre temperature increase. The tyre heats up while the vehicle is being driven and the tyre pressure will rise accordingly. For this reason, you should only adjust the tyre pressures when they are cold (i.e. approximately at ambient temperature).

To ensure that the tyre pressure monitoring system works reliably, you should check and, if necessary, adjust the tyre pressures at regular intervals and store the correct pressures (reference values) in the system.

A tyre pressure information label is attached to the inside of the fuel tank flap.

#### WARNING

- Never adjust tyre pressure when the tyres are hot. This may damage or even burst the tyres. Risk of accident!
- An insufficiently inflated tyre flexes a lot more at high speeds and causes significant heating of the tyre. Under these conditions, the tyre bead may be released or the tyre may burst. Risk of accident!



#### For the sake of the environment

Under-inflated tyres lead to increased fuel consumption and tyre wear.

### Significant tyre pressure loss

The tyre symbol (⚠) is displayed and indicates that the tyre pressure of at least one tyre is insufficient.

- Stop the vehicle.
- Switch the engine off.
- Check the tyre(s).
- Change the wheel if necessary.

### Tyre pressure monitoring (RKA+)\*

*The tyre pressure monitor display on the instrument panel indicates if the pressure is too low.*



**Fig. 189** Detailed view of the centre console: Button for the tyre pressure monitoring system

The tyre pressure monitoring system makes use of the ABS sensors to compare the rolling circumference and the frequency characteristics of the wheels. If the rolling circumference or frequency characteristic changes on one or more wheels, the tyre pressure warning lamp (⚠) will light up. The fault will also be indicated by a warning buzzer. The position of the affected tyre will also be shown (if only one tyre is affected) on the centre display of the instrument panel.

The rolling circumference and frequency characteristics can change if:

- the tyre pressure is too low.
- the tyre has suffered structural damage.
- the wheels or the inflation pressures have been changed without initialising the system (see Adjusting the tyre pressure settings).
- there is a greater load on the wheels of one axle (e.g. if you are carrying more passengers or luggage).
- the road surface under the left wheels is different to the road surface under the right wheels for a long period.
- when driving with snow chains.

#### Adjusting the tyre pressure settings (initialising the tyre pressure monitoring system)

After any incident regarding the wheels of your vehicle, e.g. after modifying the tyre pressure ⇒ page 253 or after changing or swapping wheels ⇒ page 253 you should - with the vehicle at a standstill and the engine running - press ⇒ Fig. 189. The yellow warning lamp (⚠) will light up. Hold the button down for 2 seconds until the warning lamp goes out and an acoustic warning is given. You can now release the button.

If the wheels are subjected to extreme stress (e.g. heavy load), the tyre pressure must be increased to the recommended value for the maximum load (see the adhesive label on the inside of the fuel tank flap) and then initialise the system. ▶

### Tyre pressure warning lamp on

When you switch on the ignition, the tyre pressure warning lamp (⚠) will light up for about 2 seconds. There is a fault in the system if the indicator stays on permanently after switching on the ignition. The instrument panel also display TMPS (Tyre Pressure Monitoring System). Please contact the nearest specialised workshop as soon as possible.

The tyre pressure warning lamp (⚠) lights up if the tyre pressure on one or more wheels is significantly lower than the tyre pressure setting which was confirmed by the driver ⇒ ⚠.



#### WARNING

- If the tyre pressure warning lamp lights up (⚠) you must slow down immediately and avoid any severe braking or steering manoeuvres. Stop the vehicle as soon as possible and check the tyres and their pressure.
- The driver is responsible for maintaining correct tyre pressures. Therefore, the tyre pressure must be regularly checked.
- Under certain conditions (e.g. driving at high speeds, on ice and snow or on poor road surfaces) the tyre pressure warning lamp (⚠) may not light up immediately or not at all.
- Please ask your Technical Service or specialised workshop whether run-flat tyres can be used on your vehicle. Fitting this type of tyre in an undue manner could lead to your driving licence being taken away from you. Furthermore, it may lead to damage to the vehicle or, under certain circumstances, may cause accidents.
- If you change normal tyres for run-flat tyres or vice versa, the control unit must be reprogrammed by the Technical Service or a specialised workshop.



#### Note

If you did **not** press the button for the tyre pressure monitoring system to confirm a new tyre pressure setting after making changes to the tyre pressures or changing one or more wheels, the warning lamp (⚠) may light up although the tyre pressures are correct. In this case, stop the vehicle as soon as possible and, after examining the tyres, press the button for the tyre pressure monitoring system. ■

### Tyre service life

*The service life of tyres is dependent on tyre pressure, driving style and fitting.*



Fig. 190 Tyre tread wear indicators

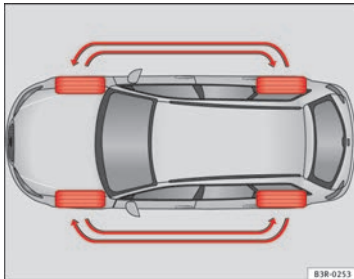

Fig. 191 Diagram for changing wheels

### Wear indicators

The original tyres on your vehicle have 1.6 mm high “tread wear indicators” ⇒ Fig. 190, running across the tread. Depending on the make, there will be 6 to 8 of them evenly spaced around the tyre. Markings on the tyre sidewall (for instance the letters “TWI” or other symbols) indicate the positions of the tread wear indicators. The minimum tread depth required by law is 1.6 mm (measured in the tread grooves next to the tread wear indicators). Worn tyres must be replaced. Different figures may apply in export countries ⇒ ⚠.

### Tyre pressure

Under-inflation or over-inflation will reduce the life of the tyres considerably and also impair the vehicle's handling. The inflation pressures are listed on a sticker on the inside of the fuel tank flap.

Correct inflation pressures are very important, especially at **high speeds**. The pressure should therefore be checked at least once a month and before starting any long journey.

### Tyre pressure monitoring (RKA+)\*

Monitoring of the tyre pressures is based on the tyre pressures you have stored. The tyre pressure monitoring system cannot function as intended if you store tyre pressure settings for a normal load, but then drive with the vehicle fully laden. The tyre pressure must be adapted to the actual load and stored accordingly in the tyre pressure monitoring system ⇒ page 251.

### Driving style

Fast cornering, heavy acceleration and hard braking all increase tyre wear.

### Changing wheels around

If the front tyres are worn considerably more than the rear ones it is advisable to change them around as shown ⇒ Fig. 191. All the tyres will then last for about the same time. ▶

### Wheel balance

The wheels on new vehicles are balanced. However, various factors encountered in normal driving can cause them to become unbalanced, which results in steering vibration.

Unbalanced wheels should be rebalanced, as they otherwise cause excessive wear on steering, suspension and tyres. A wheel must also be rebalanced when a new tyre is fitted.

### Incorrect wheel alignment

Incorrect wheel alignment causes excessive tyre wear, impairing the safety of the vehicle. If tyres show excessive wear, you should have the wheel alignment checked by a Technical Service.



#### WARNING

**There is a serious danger of accidents if a tyre bursts during driving!**

- **The tyres must be replaced at the latest when the tread wear indicators are worn ⇒ page 253. Failure to do so could result in an accident. Worn tyres do not grip well at high speeds on wet roads. There is also a greater risk of aquaplaning.**
- **At continuously high speeds, a tyre with insufficient pressure flexes more. This causes it to overheat. This can cause tread separation and tyre blow-out. Risk of accident. Always observe the recommended tyre pressures.**
- **If tyres show excessive wear, you should have the running gear checked by a Technical Service.**
- **Keep chemicals such as oil, fuel and brake fluid away from tyres.**
- **Damaged wheels and tyres must be replaced immediately!**



### For the sake of the environment

Under-inflated tyres will increase fuel consumption. ■

### Run-flat tyres\*

*Run-flat tyres allow you to continue driving even with a punctured tyre, in the majority of cases.*

In vehicles that are factory-fitted with run-flat tyres<sup>1)</sup> the loss of tyre pressure is indicated on the instrument panel.

#### Driving with run-flat tyres (emergency running)

- Leave the ESC/ASR on (Electronic Stability Control), or switch it on ⇒ page 71.
- Continue driving carefully and slowly (80 km/h maximum).
- Avoid sudden manoeuvres and sharp turns.
- Avoid driving over obstacles (for example kerbs) or potholes.
- Pay attention if the ESC/ASR activates often, if smoke comes from the tyres or there is a smell of rubber, if the vehicle vibrates or there are clattering noises. If any of these occur, stop the vehicle.

The run-flat tyres have a tag on the side of the tyre, with the description: “DSST”, “Eufonia”, “RFT”, “ROF”, “RSC”, “SSR” or “ZP”.

The sides of this type of tyre are reinforced. When the tyres lose air they are supported on the sides (emergency driving).

The loss of pressure in the tyre is shown on the instrument panel. You can then drive a maximum of 80 km and if the circumstances are favourable (for example, low load), even more. ▶

<sup>1)</sup> Depending upon version and country.

The damaged tyre should be changed as soon as possible. The rim should be checked in a specialised workshop to detect possible damage and replace it if necessary. We recommend you contact Technical Service. If more than one tyre is being used under emergency conditions, this reduces the distance which can be travelled.

#### Starting driving in emergency conditions

When loss in tyre pressure is displayed on the instrument panel, this means that at least one tyre is being driven in emergency conditions ⇒ ⚠.

#### End of emergency operation

Do not drive on if:

- smoke is coming from one of the tyres,
- there is a smell of rubber,
- the vehicle vibrates,
- there is a rattling noise.

#### When is it no longer possible to continue driving even using run-flat tyres?

- If the Electronic Stability Control (ESC) does not function.
- If the tyre pressure monitoring system\* does not work.
- If one of the tyres has been severely damaged in an accident, etc. If a tyre has been badly damaged there is a risk that parts of the tread can be thrown off and cause damage to the fuel lines, brake pipes or fuel filler.
- It is also advisable to stop driving if severe vibrations occur, or if the wheel starts overheating and gives off smoke.

#### WARNING

**When driving in emergency conditions, the driving quality of the vehicle is considerably impaired.**

- **The maximum permitted speed of 80 km/h is subject to road and weather conditions. Please observe legal requirements when doing so.**

#### WARNING (Continued)

- **Avoid sharp turns and rapid manoeuvres, and brake earlier than usual.**
- **Avoid driving over obstacles (for example kerbs) or potholes.**
- **If one or more tyres are being driven in emergency conditions, the driving quality of the vehicle is impaired and there is a risk of accident.**



#### Note

- The run-flat tyres do not “deflate” on losing pressure because they are supported on the reinforced sides. Therefore defects in the tyre cannot be detected with a visual inspection.
- Snow chains must not be used on front tyres used in emergency conditions.

#### New tyres and wheels

*New tyres and wheels have to be run in.*

The tyres and wheel rims are an essential part of the vehicle's design. The tyres and rims approved by SEAT are specially matched to the characteristics of the vehicle and make a major contribution to good road holding and safe handling ⇒ ⚠.

Tyres should be replaced at least in pairs and not individually (i.e. both front tyres or both rear tyres together). A knowledge of tyre designations makes it easier to choose the correct tyres. Radial tyres have the tyre designations marked on the sidewall, for example:

195/65 R15 91T

This contains the following information: ▶

- 195 Tyre width in mm
- 65 Height/width ratio in %
- R Tyre construction: Radial
- 15 Rim diameter in inches
- 91 Load rating code
- T Speed rating

The tyres could also have the following information:

- A direction of rotation symbol
- “Reinforced” denotes heavy-duty tyres.

The manufacturing date is also indicated on the tyre sidewall (possibly only on the inner side of the wheel).

“DOT... 1103...” means, for example, that the tyre was produced in the 11th week of 2003.

We recommend that work on tyres and wheels be carried out by a Technical Service. They are familiar with the procedure and have the necessary special tools and spare parts as well as the proper facilities for disposing of the old tyres.

Any Technical Service has full information on the technical requirements when installing or changing tyres, wheels or wheel trims.



#### WARNING

- We recommend that you use only wheels and tyres which have been approved by SEAT for your model. Failure to do so could impair vehicle handling. Risk of accident.
- Avoid running the vehicle on tyres that are more than 6 years old. If you have no alternative, you should drive slowly and with extra care at all times.



#### WARNING (Continued)

- Never use old tyres or those with an unknown history of use.
- If wheel trims are retrofitted, you must ensure that the flow of air to the brakes is not restricted. This could cause them to overheat.
- All four wheels must be fitted with radial tyres of the same type, size (rolling circumference) and the same tread pattern.



#### For the sake of the environment

Old tyres must be disposed of according to the laws in the country concerned.



#### Note

- For technical reasons, it is not generally possible to use the wheels from other vehicles. This can also apply to wheels of the same model. The use of wheels or tyres which have not been approved by SEAT for use with your model may invalidate the vehicle's type approval for use on public roads.
- If the spare tyre is not the same as the tyres that are mounted on the vehicle (e.g. winter tyres) you should only use the spare tyre for a short period of time and drive with extra care. Refit the normal road wheel as soon as possible. ■

## Wheel bolts

*Wheel bolts must be tightened to the correct torque.*

The design of wheel bolts is matched to the rims. If different wheel rims are fitted, the correct wheel bolts with the right length and correctly shaped bolt heads must be used. This ensures that wheels are fitted securely and that the brake system functions correctly.

In certain circumstances, you should not use wheel bolts from a different vehicle, even if it is the same model ⇒ page 228. ▶

After the wheels have been changed, the tightening torque of the wheel bolts should be checked as soon as possible with a torque wrench. → ⚠  
The tightening torque for steel and alloy wheels is 120 Nm.

### WARNING

If the wheel bolts are not tightened correctly, the wheel could become loose while driving. Risk of accident.

- The wheel bolts must be clean and turn easily. Never apply grease or oil to them.
- Use only wheel bolts which belong to the wheel.
- If the torque of the wheel bolts is too low, they could loosen whilst the vehicle is in motion. Risk of accident! If the tightening torque is too high, the wheel bolts and threads can be damaged.



### CAUTION

The prescribed torque for wheel bolts for steel and alloy wheels is 120 Nm. ■

## Winter tyres

*Winter tyres will improve the vehicles handling on snow and ice.*

In winter conditions winter tyres will considerably improve the vehicle's handling. The design of summer tyres (width, rubber compound, tread pattern) gives less grip on ice and snow.

Winter tyres must be inflated to a **pressure** 0.2 bar higher than the pressures specified for summer tyres (see sticker on tank flap).

Winter tyres must be fitted on all four wheels.

Information on permitted **winter tyre sizes** can be found in the vehicle's registration documents. Use only radial winter tyres. All tyre sizes listed in the vehicle documentation also apply to winter tyres.

Winter tyres lose their effectiveness when the tread is worn down to a depth of 4 mm.

The speed rating code → page 255, New tyres and wheels determines the following **speed limits** for winter tyres: → ⚠

Q	max. 160 km/h
S	max. 180 km/h
T	max. 190 km/h
H	max. 210 km/h

In some countries, vehicles which can exceed the speed rating of the fitted tyre must have an appropriate sticker in the driver's field of view. These stickers are available from your Technical Service. The legal requirements of each country must be followed.

Do not have winter tyres fitted for unnecessarily long periods. Vehicles with summer tyres handle better when the roads are free of snow and ice.

If you have a flat tyre, please refer to the notes on the spare wheel → page 255, New tyres and wheels.

### WARNING

**The maximum speed for the winter tyres must not be exceeded. Otherwise, this could lead to tyre damage and risk of accident.**



### For the sake of the environment

Fit your summer tyres again as soon as possible. They are quieter, do not wear so quickly and reduce fuel consumption. ■

### Snow chains

Snow chains may be fitted only to the front wheels, and only to certain tyre sizes ⇒ page 303.

205/55 R16	15 mm chains
225/45 R17	9 mm chains
225/40 R18	7 mm chains

Remove wheel hub covers and trim rings before fitting snow chains. For safety reasons cover caps, available in any Technical Service, must then be fitted over the wheel bolts.



#### WARNING

Observe the fitting instructions provided by the snow chain manufacturer.



#### CAUTION

Remove the snow chains to drive on roads without snow. Otherwise they will impair handling, damage the tyres and wear out very quickly.



#### Note

- In some countries, the speed limit for using snow chains is 50 km/h. The legal requirements of the country should be followed.
- We recommend that you ask your Technical Service for information about appropriate wheel, tyre and snow chain size. ■

## If and when

### Tools, tyre repair kit and spare wheel

#### Tools

The tools and jack are stored under the floor panel in the luggage compartment.

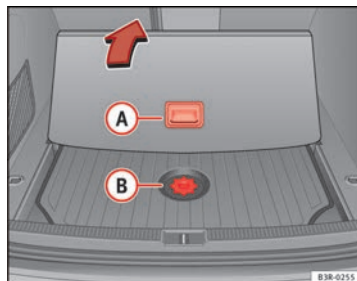

Fig. 192 Access to the toolbox and jack

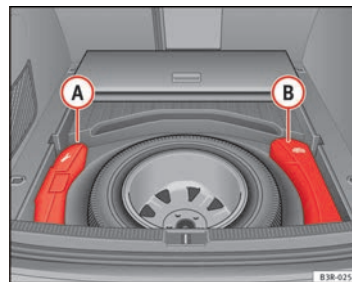

Fig. 193 Toolbox and jack

The tools (A) and jack (B) ⇒ Fig. 193 for vehicles with a spare wheel and for vehicles with the tyre repair kit are stored under the floor panel in the luggage compartment.

- Take hold of handle (A) and fold back the floor panel in the luggage compartment ⇒ Fig. 192.
- Unscrew the attachment screw from cover (B) ⇒ Fig. 192.
- Remove cover.
- Release the toolbox by pulling up the handle on the box (vehicles equipped with spare wheel).
- Take out the tools or jack.

The tool kit includes: ▶

- A hook for removing wheel covers\* or hub caps
- Box spanner for wheel bolts
- Towing eye
- An adapter for the anti-theft wheel bolts\*

Before replacing the jack in the storage bin, wind down the arm of the jack as far as it will go.

Some of the tools listed are only provided in certain models or are optional extras.

### WARNING

- **The factory-supplied jack is only designed for changing wheels on this model. On no account attempt to use it for lifting heavier vehicles or other loads. Risk of injury.**
- **Never start the engine when the vehicle is raised. Failure to do so could result in an accident.**
- **If work is to be carried out underneath the vehicle, this must be secured by suitable stands. Otherwise, there is a risk of injury.**

## Tyre mobility system

*The tyre mobility system is stored under the floor panel in the luggage compartment.*



**Fig. 194 Tyre Mobility System under floor panel in luggage compartment**

- Take hold of the handle and fold back the floor panel in the luggage compartment.
- Take out the tyre mobility system.

Your vehicle is equipped with a Tyre Mobility System in case of a puncture.

The tyre mobility system consists of a container with **sealing compound** and a **compressor** to generate the required tyre pressure.

Instructions for using the sealant compound and the compressor are included with the sealant can.

## Spare steel rim wheel

*The spare steel rim wheel is carried in the wheel well under the floor panel in the luggage compartment. It is only intended for temporary use over short distances.*

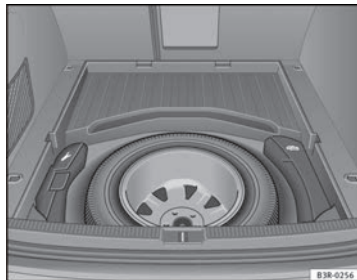

Fig. 195 Spare steel rim wheel

### Taking out the spare wheel

- Turn the plastic knob ⇒ Fig. 195 anticlockwise.
- Take out the spare wheel.

### Securing the defective wheel in the spare wheel well

- Place wheel in spare wheel well in the luggage compartment.
- Secure the wheel by turning plastic knob clockwise.
- Replace the floor panel before closing the rear lid.

Your vehicle can be factory-equipped with a spare steel wheel. The spare wheel does **not** usually meet the same performance standards as the

wheels fitted on the vehicle because of the wheel/tyre dimensions, rubber composition, tread pattern, etc. Therefore, note the following restrictions:

- The spare steel wheel is designed only for your vehicle model. Do not attempt to mount the wheel on any vehicle but your own.
- Your vehicle will have different driving characteristics when the spare steel rim wheel is mounted ⇒ ⚠.
- The spare wheel is only intended for temporary use after having a flat tyre. Replace the spare wheel with a normal wheel that has the proper tyre dimensions as soon as possible.
- If the size of the spare steel rim wheel is different to that of the other wheels, it is unlikely that snow chains suitable for the other wheels will fit it.



### WARNING

- After mounting the spare steel rim wheel, the tyre pressure must be checked and corrected as soon as possible. The tyre pressure must correspond to the vehicle load (consult the table containing the inflation pressures). Otherwise there is danger of causing an accident. Use the highest tyre pressure as indicated in the table.
- Do not drive faster than 80 km/h, as higher speeds can cause an accident.
- Avoid heavy acceleration, hard braking and fast cornering, as this could cause an accident.

## Changing a wheel

### Preparation work

*What you must do before changing a wheel.*

- If you have a flat tyre or puncture, park the vehicle as far away from the flow of traffic as possible. Choose a location that is as **level** as possible.
- All passengers should **leave** the vehicle. They should wait in a safe place (e.g. behind the roadside crash barrier).
- Apply the **handbrake** firmly.
- Engage **first gear**.
- When towing a trailer: Unhitch the trailer from your vehicle.
- Take the **tools** and the **spare wheel** ⇒ page 259 out of the luggage compartment.



#### WARNING

If you have a puncture in heavy traffic, switch on the hazard warning lights and place the warning triangle in a visible location. This is for your own safety and also warns other road users.



#### CAUTION

If you have to change the tyre on a gradient, block the wheel opposite the wheel being changed by placing a stone or similar object under it to prevent the vehicle from rolling away.



#### Note

Please observe legal requirements when doing so. ■

### Changing a wheel

*Change the wheel as described below.*

- Remove the **wheel cover**.
- Loosen the **wheel bolts** ⇒ page 263.
- **Raise** the vehicle with the jack ⇒ page 264.
- **Take off** the wheel with the flat tyre and then **put on** the spare wheel ⇒ page 265.
- **Lower** the vehicle.
- Tighten the wheel bolts **firmly** in diagonal sequence with the box spanner ⇒ page 263.
- Replace the **cover**. ■

### After changing a wheel

*After changing the wheel, there are still tasks to complete.*

- Place the wheel with the defective tyre **in the spare wheel well** and secure it.
- Put the tools and jack back in the luggage compartment. ►

- The **inflation pressure** of the newly fitted spare tyre must be checked as soon as possible.
- Have the **tightening torque** of the wheel bolts checked as soon as possible with a torque wrench. It must be 120 Nm (always when cold)
- Have the flat tyre **replaced** as quickly as possible.



#### Note

- If you notice that the wheel bolts are rusty and difficult to turn when changing a wheel, they must be replaced before having the tightening torque checked.
- For safety reasons, drive at moderate speeds until the wheel bolt tightening torque has been checked.

### Loosening and tightening the wheel bolts

*The wheel bolts must be loosened before raising the vehicle.*



**Fig. 196** Changing the wheel: Loosen the wheel bolts

#### Loosening

- Fit the **box spanner** as far as it will go over the wheel bolt<sup>1)</sup>.
- Grip the box spanner as close to the *end* as possible and turn the wheel bolts about *one* turn **anticlockwise** ⇒ Fig. 196 (arrow).

#### Tightening

- Fit the box spanner as far as it will go over the wheel bolt<sup>1)</sup>.
- Grip the box spanner as close to the *end* as possible and tighten the bolt firmly by turning **clockwise**.

<sup>1)</sup> An adapter is required to unscrew or tighten the anti-theft wheel bolts\* ⇒ page 265.

**!** WARNING

Loosen the wheel bolts only about one turn before raising the vehicle with the jack. Failure to do so could result in an accident.

**i** Note

- If the wheel bolt does not come loose, it may be possible to release it by pushing down the end of the spanner carefully with your *foot*. Hold on to the vehicle for support and take care not to slip.

### Raising the vehicle

*In order to remove the wheel, the vehicle must be raised with a jack.*

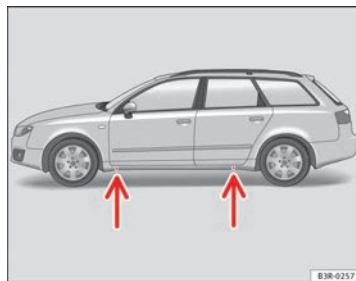

**Fig. 197** Changing the wheel: jack position points

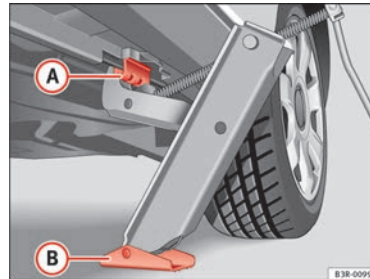

**Fig. 198** Changing the wheel: Jack

- Position the vehicle jack under the door sill at the **jacking point** closest to the wheel being changed ⇒ Fig. 197 -arrows-.
- Wind up the **jack** under the jacking point until the claw of the jack is directly below the vertical rib under the door sill.
- Align the jack so that the arm of the jack fits on the rib under the door sill ⇒ Fig. 198 **A** and the movable base plate of the jack **B** is flat on the ground.
- Raise the vehicle until the defective wheel is just clear of the ground.

Recesses at the front and rear of the door sills mark the jacking points ⇒ Fig. 197 -arrows-. There is only *one* jacking point for each wheel. Do not fit the jack anywhere else.

The distance from the jacking points to the wheel arches is approximately 15 cm at the front and 25 cm at the rear.

An **unstable surface** under the jack may cause the vehicle to slip off the jack. Therefore, the jack must be fitted on solid ground offering good support. Use a large, stable base if necessary. On a **hard, slippery surface** (such as tiles) use a rubber mat or similar to prevent the jack from slipping.

### WARNING

- Take all precautions so that the base of the jack does not slip. Failure to do so could result in an accident.
- The vehicle can be damaged if the jack is not applied at the correct jacking points. There is also a risk of injury since the jack can slip off suddenly if it is not properly engaged.

## Removing and fitting the wheel

*For removal and fitting the wheel, the following tasks must be completed.*

After loosening the wheel bolts and raising the vehicle with the jack, change the wheel as described below:

### Removing a wheel

- Unscrew the wheel bolts using the box spanner and place them on a clean surface.

### Fitting a wheel

- Screw on the wheel bolts in position and tighten them loosely with a box spanner.

The wheel bolts should be clean and easily screwed. Before fitting the spare wheel, inspect the wheel condition and hub mounting surfaces. These surfaces must be clean before fitting the wheel.

If tyres with a specific direction of rotation are fitted, note the direction of rotation.

## Anti-theft wheel bolts\*

*A special adapter is required to turn the anti-theft wheel bolts.*

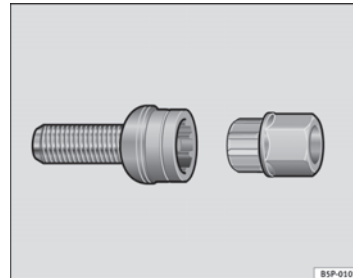

Fig. 199 Anti-theft wheel bolt

- Insert the adapter onto the wheel bolt and push it on as far as it will go => Fig. 199.
- Fit the box spanner as far as it will go over the adapter.
- Loosen or tighten the wheel bolt as appropriate.

### Code

The code number of the anti-theft wheel bolt is stamped onto the front part of the adaptor.

The code number should be noted and kept in a safe place, as it is only by using the code number that a duplicate adaptor can be obtained from the SEAT Official Services.

### Tyres with directional tread pattern

*Tyres with directional tread pattern must be fitted so that they rotate in the correct direction.*

A directional tread pattern can be identified by arrows on the sidewall that point in the direction of rotation. Always note the direction of rotation indicated when fitting the wheel. This is important so that these tyres can give maximum grip and avoid excessive noise, tread wear and aquaplaning.

If, in an emergency, you have to fit the spare wheel so it rotates in the wrong direction, you must drive extremely carefully. The tyre will not give optimum performance. This is particularly important when driving on wet roads.

To benefit from the advantages of tyres with this type of tread pattern, the defective tyre should be replaced as soon as possible so that all tyres again rotate in the correct direction.

## Tyre repair\* (Tyre-Mobility-System)

### General information and safety notes

*Repaired tyres are only suitable for temporary use over a short period.*



**Fig. 200** The Tyre Mobility System is not suitable for repairing this type of damage to tyres.

Your vehicle is equipped with a tyre repair kit: the **Tyre Mobility System**.

In the event of a puncture you will find the **TMS**, which consists of a sealing compound and a compressor, located under the floor panel in the luggage compartment.

The **Tyre Mobility System** will reliably seal tyres damaged by foreign bodies, provided that the cuts or punctures are no larger than approx. **4 mm**.

It is not necessary to remove the foreign body from the tyre. ▶

**The sealing compound must not be used in the following cases:**

- If the cuts and punctures on the tyre are longer than 4 mm → Fig. 200 ①
- If the wheel rim has been damaged ②
- If you have been driving with very low pressure or a completely flat tyre ③

How to use the **TMS (tyre mobility system)** is described in the section **Repairing a tyre** → page 268 and in the instructions supplied with the tyre sealant can.

The **TMS (tyre mobility system)** can be used at outside temperatures down to - 20°C.

 **WARNING**

After repairing a tyre please note the following points:

- Do not drive faster than 80 km/h.
- Avoid heavy acceleration, hard braking and fast cornering.
- Vehicle handling could be impaired.
- Tyres which have been sealed using the Tyre Mobility System are only suitable for temporary use over a short period.
- After using the tyre sealant the tyre pressure monitoring system\* may malfunction. Therefore, please drive carefully to the next available specialised workshop.
- The Tyre Mobility System must NOT be used:
  - If the cuts and punctures on the tyre are longer or wider than 4 mm.
  - if the wheel rim has been damaged.
  - if you have been driving with very low pressure or a completely flat tyre.
- Seek professional assistance if the repair of a tyre puncture is not possible with the sealing compound.

 **WARNING (Continued)**

- Do not allow the sealant to come into contact with your eyes, skin or clothing.
  - If you do come into contact with the sealant immediately rinse the eyes or skin affected with clean water.
- Change clothing immediately if it becomes soiled with the tyre sealant.
  - Make sure you do not breathe in the fumes!
- If any of the tyre sealant is accidentally ingested, immediately rinse the mouth thoroughly and drink lots of water.
  - Do not induce vomiting. Seek medical assistance if needed.
- If any allergic reactions should occur get medical help immediately.
- Keep the sealant away from children.



**For the sake of the environment**

If you have to dispose of a sealant can, go to a specialised waste service or to a SEAT Technical Service, where the product can be recycled in an appropriate waste container.



**Note**

- If sealant should leak out, leave it to dry. This way you can pull it off like a piece of foil.
- Observe the expiry date stated on the sealing compound can. Have the sealing compound exchanged by a specialised workshop. ■

## Repairing a tyre

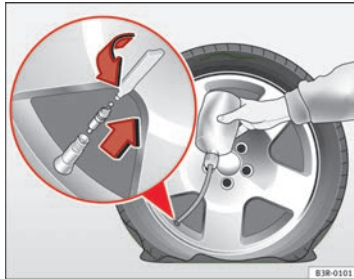



Fig. 201 Repairing a tyre

### Preparations

- If you have a flat tyre or puncture, park the vehicle as far away from the flow of traffic as possible.
- Apply the **handbrake** firmly to prevent the vehicle from moving accidentally on slopes.
- Engage **first gear**.
- Check whether a repair is possible using the Tyre Mobility System ⇒ page 266.
- Ensure that all passengers **leave the vehicle** and move away from the danger area ⇒ .
- Take the **tyre sealant can** and the **compressor** out of the luggage compartment.

- Stick the “max. 80 km/h” adhesive, which is included with the tyre sealant can, onto the instrument panel where the driver will see it.

### Filling the tyre

- Shake the tyre sealant can well.
- Screw the enclosed filling hose onto the sealant can as far as it will go. This will automatically pierce the foil sealing the can.
- Take the valve cap off the tyre valve and use the enclosed valve insert tool to unscrew the valve insert ⇒ Fig. 201.
- Place the valve insert onto a clean surface.
- Remove the sealing plug from the filling hose and insert the hose into the tyre valve.
- Hold the tyre sealant can upside down and fill the complete contents of the can into the tyre.
- Then disconnect the hose and screw the valve insert firmly back into the tyre valve.

### Inflating the tyre

- Screw the compressor filling hose onto the tyre valve and plug the connector into the cigarette lighter.
- Pump the tyre up to 2.0 to 2.5 bar and monitor the pressure shown on the pressure gauge.
- If the tyre pressure remains lower than the value specified above drive the vehicle approx. 10 metres forwards or backwards, so that the sealant can spread evenly in the tyre. If the ►

pressure is still lower than the specification the tyre is too badly damaged and cannot be repaired using the tyre sealant.

#### Final check

- After about 10 minutes, stop to check the tyre pressure.
- If tyre pressure is less than 1.3 bar, the tyre is too badly damaged. Do not drive on! You should obtain professional assistance.



#### WARNING

- If you have a puncture in heavy traffic, switch on the hazard warning lights and place the warning triangle in a visible location. This is for your own safety and also warns other road users.
- Make sure your passengers wait in a safe place (for instance behind the roadside crash barrier).
- Please observe the manufacturer's safety notes on the compressor and the instructions supplied with the tyre sealant can.
- If it is not possible to build up a tyre pressure of 2.0 bar within 6 minutes this means that the tyre is too badly damaged. Do not drive on!
- Seek professional assistance if the repair of a tyre puncture is not possible with the sealing compound.
- If tyre pressure is less than 1.3 bar after driving about 10 minutes, the tyre is too badly damaged. Do not drive on! Obtain technical assistance.



#### CAUTION

Take special care if you have to repair a tyre on a slope.



#### Note

- Do not use the compressor for longer than 6 minutes. Otherwise, it might overheat. When the compressor has cooled down, you can use it again.
- If tyre sealant should leak out, leave it to dry and then pull it off like foil.
- After carrying out a tyre repair remember to buy a new tyre sealant can at a specialised workshop. This will ensure that the Tyre Mobility System is operative again.
- Please observe legal requirements when doing so. ■

## Fuses

### Changing fuses

*If a fuse has blown, it must be replaced.*

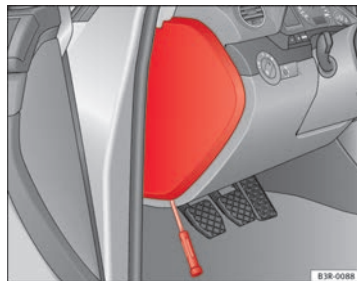

Fig. 202 Left side of dash panel: Fuse box cover

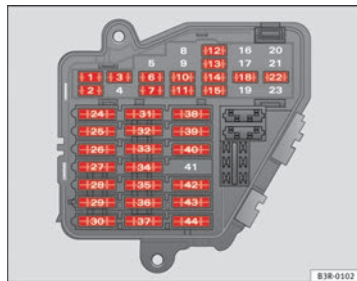

Fig. 203 Schematic drawing of fuse box at the left-hand end of dash panel: Fuses (without fuse cover)

- Switch off the ignition and its failed electrical component.
- Remove the fuse cover using a screwdriver ⇒ Fig. 202.
- Identify the fuse corresponding to the damaged electric consumer ⇒ page 271, Fuse assignment.
- Take the plastic clip from inside the fuse cover, fit it onto the blown fuse, and pull the fuse out.
- Replace the blown fuse (which will have a melted metal strip) with a new fuse of the *same* amp rating.
- Fit the fuse cover back on.

The individual electrical circuits are protected by fuses. The fuses are located behind a cover at the left-hand end of the dash panel.

Two spare fuses and a sticker identifying the fuses are provided on the inside of the fuse cover. There is also a crank handle for operating the sun-roof\* by hand (if the electrical system fails).

#### ! CAUTION

Never “repair” damaged fuses and never replace them with fuses with a higher rating. Failure to comply could result in fire. It could also cause damage to other parts of the electrical system.

#### i Note

If a newly replaced fuse blows again after a short time, the electrical system must be checked by a specialised workshop as soon as possible. ■

## Fuse assignment

*This list shows the fuses which can be replaced relatively easily by the owner.*

No.	Consumer	Amps
1	Air conditioner	10
2	Footwell lamps	5
3	Heated washer jets	5
4	Radiator fan	5
5	Parking aid, automatic gearbox	10
6	Air conditioner (air purity sensor), pressure sensor	5
7	Electronic Stability Control (ESC), brake light switch, clutch pedal switch, steering angle sensor	10
8	Telephone	5
9	Lambda probe heater	10
10	Adaptive headlights right	5
11	Airbag and disconnection of the front passenger air-bag	5
12	Diagnostic socket	10
13	Steering column unit	10
14	Brake lights	10
15	Instrument panel	10
16	Vacant	
17	Tyre pressure control, rain/light sensor	10
18	Adaptive headlights left	5
19	Start-Stop control unit	10
20	Engine management	15
21	Start/Stop battery power management	5
22	Vacant	
23	Vacant	

No.	Consumer	Amps
24	Central electrics unit for convenience equipment	20
25	Heater blower	30
26	Rear window heater	30
27	Power socket for trailer (control unit)	30
28	Fuel pump, auxiliary pump for diesel	20
29	Radio, amplifier (with Start-Stop)	20
30	Sliding/tilting sunroof	20
31	Diagnosis connection, automatic anti-dazzle interior mirror, reverse light, automatic gearbox	15
32	Towing socket	15
33	Lighter	20
34	Rear electric windows	30
35	Luggage compartment power socket*	20
36	Wiper system	30
37	Pump for windscreen washer and headlight washer system	30
38	Luggage compartment illumination, alarm	15
39	Radio, amplifier (without Start-Stop)	20
40	Horn	25
41	230 volt socket	30
42	Electronic Stability Control (ESC)	25
43	Front electric windows	30
44	Seat heating	35

Some of the electrical items listed in the table are only fitted on certain models or are optional extras. ▶

**Note**

Please note that the above list contains all data at the time of going to press, so it is subject to modifications. If discrepancies should occur, please refer to the sticker on the inside of the fuse cover for the correct information for your model.

## Bulbs

### General information

---

You can change the following bulbs for exterior lights **yourself**:

- Main headlights: all bulbs (except xenon headlights)
- Tail lights: all bulbs
- Side turn signal bulb

The following bulbs can only be changed by a **specialised workshop**:

- Main headlights: Xenon\* bulb ⇒ page 279
- Front fog lights: Bulb

As a rule, you require a certain degree of practical skill to change defective bulbs. This applies in particular to those bulbs which are only accessible from the engine compartment.

If in doubt, we recommend that you have defective bulbs changed by a specialised workshop or qualified mechanic.

If you do decide to change bulbs in the engine compartment yourself, be aware of the safety risks involved ⇒ page 234 ⇒  in Types of bulbs on page 273.

The name of many of the lamps fitted by SEAT ends in "LL". This means Long Life. These lamps are used for functions with a long service time (dipped beam, side lights, daylight driving, etc.). This does not apply to lamps with a shorter service time (turn signals, etc.). A lamp with the same name except for the last two letters, "LL" or "SLL", is compatible, but will have a service life of approximately half of the LongLife lamps.

When replacing lamp bulbs, the same type of bulb as originally fitted should always be used where possible.

## Changing bulbs. Halogen headlights

### Types of bulbs

You must only replace a bulb with a bulb of the same type. The name can be found on the base of the bulb holder.

Bulb	Type
Dipped beam headlights (halogen)	12 V/55 W (H7 LL)
Main beam headlights	12 V/55 W (H1)
Turn signal	12 V/21 W (PY21W)
Side lights	12 V/5 W (W5W LL)

#### WARNING

- Take particular care when working on components in the engine compartment if the engine is warm - risk of burns!
- Bulbs are highly sensitive to pressure. The glass can break when you touch the bulb, causing injury.
- The high voltage element of gas discharge bulbs\* (xenon light) must be handled correctly. Otherwise, there is a risk of death.
- When changing bulbs, please take care not to injure yourself on sharp parts in the headlight housing.

#### CAUTION

- Remove the ignition key before working on the electric system. If not, a short circuit could occur.
- Switch off the lights or parking lights before you change a bulb.



#### For the sake of the environment

Please ask your specialist retailer how to dispose of used bulbs in the proper manner.



#### Note

- Depending on weather conditions (cold or wet), the front lights, the fog lights, the tail lights and the turn signals may be temporarily misted. This has no influence on the useful life of the lighting system. By switching on the lights, the area through which the beam of light is projected will quickly be demisted. However, the edges may continue to be misted.
- Please check at regular intervals that all lighting (especially the exterior lighting) on your vehicle is functioning properly. This is not only in the interest of your own safety, but also in that of all other road users.
- Before changing a bulb, make sure you have the correct new bulb.
- Do not touch the glass part of the bulb with your bare hands, use a cloth or paper towel instead. Otherwise, the fingerprints left on the glass will vaporise as a result of the heat generated by the bulb, be deposited on the reflector and impair its surface.

### Removing the air duct

The air duct has to be removed to gain access to the bulbs for the right-side headlight.

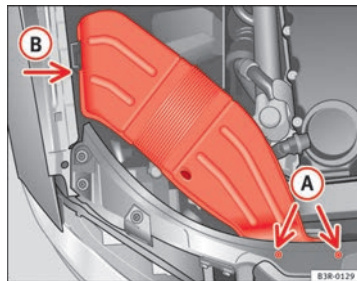

Fig. 204 Air duct on right side of vehicle

- Unscrew bolts (A) ⇒ Fig. 204.
- Detach air duct from guide (B) and take it out.

### Fitting the air duct

Once the bulb(s) for the right-side headlight have been changed, the air duct must be re-installed.

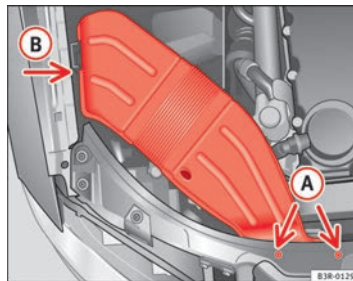

Fig. 205 Air duct on right side of vehicle

- Place the air duct in the correct position.
- – First turn the two screws (A) in lightly, then tighten both screws.
- Push the air duct into guide (B). ■

## Halogen headlight bulbs

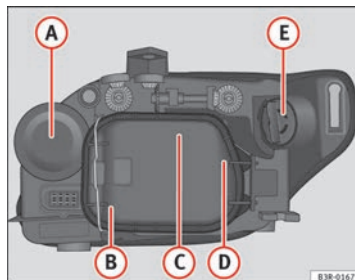

Fig. 206 Halogen bulbs

- A Main beam headlights
- B Side lights
- C Dipped beam headlights
- D Side lights
- E Turn signal

## Changing the turn signal bulb

The procedure for changing the bulb is the same on both sides.

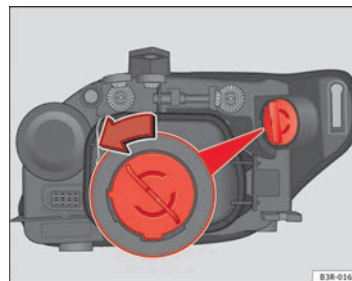

Fig. 207 Turn signal

- Switch off the ignition and the lights.
- – Raise the bonnet.
- Turn the bulb holder anticlockwise, pulling it by the grip  
⇒ Fig. 207 and removing the bulb holder and the bulb.
- Replace the blown bulb in the bulb holder (press and turn anticlockwise to remove) with a new bulb (press and turn clockwise to insert).
- Installation is done in the reverse order.
- Check whether the new bulb is working. ▶

**Note**

Although it is not necessary, previously remove the rigid cover ⇒ Fig. 210 for easier turn signal bulb changes.

### Changing the main headlight bulb

The procedure for changing the bulb is the same on both sides.

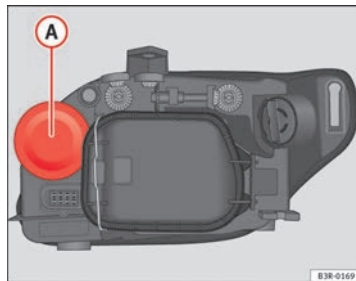

Fig. 208 Main beam headlights

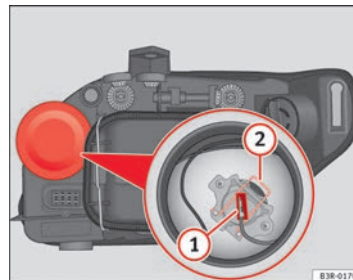

Fig. 209 Main beam headlights

- Switch off the ignition and the lights.
- Raise the bonnet.
- Pull up on the rubber cover **A** ⇒ Fig. 208 to remove it.
- Remove the connector ⇒ Fig. 209 **1** from the bulb.
- Press the spring ⇒ Fig. 209 **2** inwards and to the right.
- Remove the bulb, pulling it from the connection terminal and fitting fit the replacement so that it sits correctly in the cut-out on the reflector. To ensure correct lighting, the filament must be vertical. When changing the bulb, you can check the position of the bulb through the headlight glass.
- Installation is in reverse order, ensuring that the rubber cover is well fitted to the housing.
- Check whether the new bulb is working.
- Have the headlight settings checked as soon as possible.

### Changing the dipped beam headlight bulb

The procedure for changing the bulb is the same on both sides.

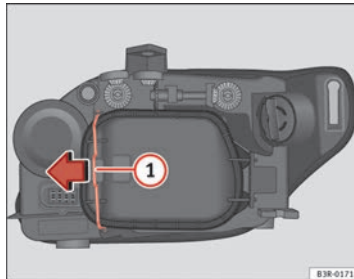

Fig. 210 Dipped beam headlights

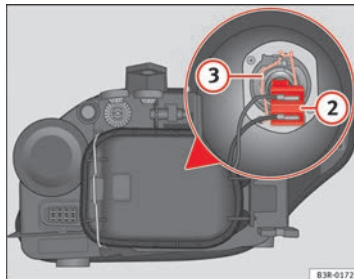

Fig. 211 Dipped beam headlights

- Switch off the ignition and the lights.

- Raise the bonnet.
- Move the brace ⇒ Fig. 210 ① in the direction of the arrow and remove the rigid cover, separating the brace side and then removing the two tabs from the other end of the cover.
- Pull the connector ⇒ Fig. 211 ② from the bulb.
- Unclip the retainer spring ⇒ Fig. 211 ③ pressing inwards to the right.
- Remove the bulb and fit the new one in the headlight casing with the tab upwards, starting to position it from below.
- Clip on the spring, raising it and pressing it slightly while turning it anticlockwise. To ensure correct lighting, the filament must be vertical. When changing the bulb, you can check the position of the bulb through the headlight glass.
- Connect the connector to the bulb.
- Fit the cover, first inserting the side tabs and then closing the cover and the brace. Make sure that the gasket sits well on the casing cover during the operation.
- Check whether the new bulb is working.
- Have the headlight settings checked as soon as possible. ■

### Changing the side light bulb (outside of vehicle)

The procedure for changing the bulb is the same on both sides.

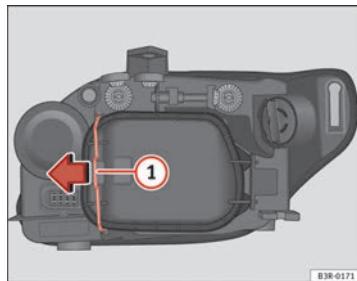

Fig. 212 Side light bulb (outside of vehicle)

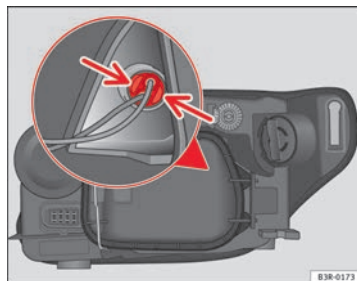

Fig. 213 Side light bulb (outside of vehicle)

- Switch off the ignition and the lights.

- Raise the bonnet.
- Move the brace ⇒ Fig. 212 ① in the direction of the arrow and remove the rigid cover, separating the brace side and then removing the two tabs from the other end of the cover.
- Gently press on the bulb holder tabs ⇒ Fig. 213 and pull the cover upwards (it can also be removed by pulling on the bulb holder wires).
- Separate the bulb from the bulb holder by pulling both pieces anticlockwise.
- Fit the new bulb by pressing on the bulb holder.
- Insert the bulb into the socket and press on the bulb holder. Fit the cover, first inserting the side tabs and then closing the cover and the brace. Make sure that the gasket sits well on the casing cover during the operation.
- Check whether the new bulb is working. ■

### Changing the side light bulb (inside of vehicle)

The procedure for changing the bulb is the same on both sides.

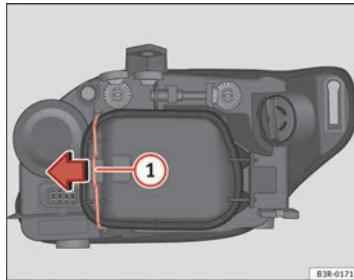

Fig. 214 Side light bulb (inside of vehicle)

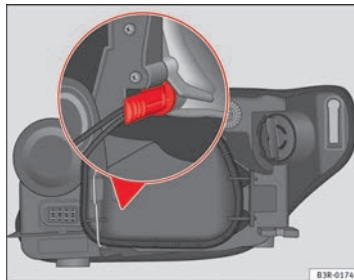

Fig. 215 Side lights. Bulb holder grip in vertical position

- Switch off the ignition and the lights.

- Raise the bonnet.
- Move the brace ⇒ Fig. 214 ① in the direction of the arrow and remove the rigid cover, separating the brace side and then removing the two tabs from the other end of the cover.
- Remove the bulb and the bulb holder by pulling on the bulb holder wiring.
- Separate the bulb from the bulb holder by pulling both pieces anticlockwise.
- Fit the new bulb by pressing on the bulb holder.
- Insert the bulb into the socket so that the side of the bulb holder grip is vertical ⇒ Fig. 215 and press on it.
- Fit the cover, first inserting the side tabs and then closing the casing cover during the operation.
- Check whether the new bulb is working. ■

## Changing bulbs. Bi-Xenon AFS headlights

### Types of bulbs

Changing bulbs requires a certain degree of practical skill

You can change the following bulb for the exterior lights yourself:

- Bulb for headlights: Indicator light 12V/21W (PY21W)

The following bulbs should only be changed by a **specialised workshop**: ▶

- Main headlight lamps: **Xenon** ⇒ ⚠ lights.
- Sources of the **DRL** (daylight) light unit and **position**.

### ⚠ WARNING

- Take particular care when working on components in the engine compartment if the engine is warm - risk of burns!
- Bulbs are highly sensitive to pressure. The glass can break when you touch the bulb, causing injury.
- The high voltage element of gas discharge bulbs\* (xenon light) must be handled correctly. Otherwise, there is a risk of death.
- When changing bulbs, please take care not to injure yourself on sharp parts in the headlight housing.

### ⚠ CAUTION

- Remove the ignition key before working on the electric system. If not, a short circuit could occur.
- Switch off the lights or parking lights before you change a bulb.



### For the sake of the environment

Please ask your specialist retailer how to dispose of used bulbs in the proper manner.



### Note

- Depending on weather conditions (cold or wet), the front lights, the fog lights, the tail lights and the turn signals may be temporarily misted. This has no influence on the useful life of the lighting system. By switching on the lights, the area through which the beam of light is projected will quickly be demisted. However, the edges may continue to be misted.
- Please check at regular intervals that all lighting (especially the exterior lighting) on your vehicle is functioning properly. This is not only in the interest of your own safety, but also in that of all other road users.

- Before changing a bulb, make sure you have the correct new bulb.
- Do not touch the glass part of the bulb with your bare hands, use a cloth or paper towel instead. Otherwise, the fingerprints left on the glass will vaporise as a result of the heat generated by the bulb, be deposited on the reflector and impair its surface. ■

### Removing the air duct

*The air duct has to be removed to gain access to the bulbs for the right-side headlight.*

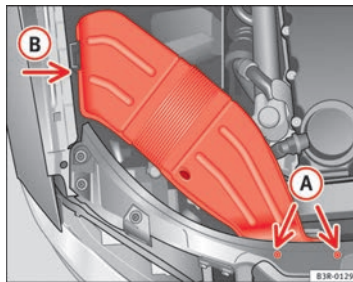

**Fig. 216** Air duct on right side of vehicle

- Unscrew bolts **A** ⇒ Fig. 216.
- Detach air duct from guide **B** and take it out. ■

### Fitting the air duct

Once the bulb(s) for the right-side headlight have been changed, the air duct must be re-installed.

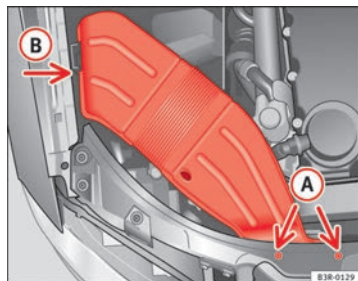

Fig. 217 Air duct on right side of vehicle

- Place the air duct in the correct position.
- First turn the two screws **A** in lightly, then tighten both screws.
- Push the air duct into guide **B**.

### Bi-Xenon AFS headlight bulbs

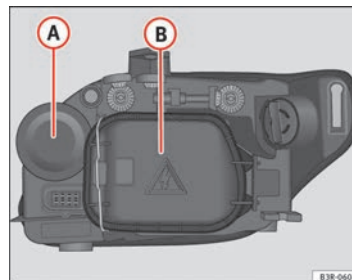

Fig. 218 Bi-Xenon AFS headlight bulbs

- A** Turn signal
- B** Xenon headlight (dipped beam/main beam)

### Changing the turn signal bulb

The procedure for changing the bulb is the same on both sides.

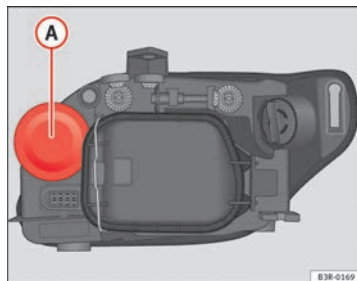

Fig. 219 Turn signal

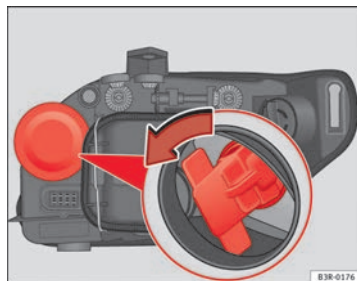

Fig. 220 Turn signal

- Switch off the ignition and the lights.

- Raise the bonnet.
- Pull the rubber cap ⇒ Fig. 219 to remove it.
- Remove the bulb holder by pulling on the grip and turning it anticlockwise ⇒ Fig. 220.
- Replace the blown bulb in the bulb holder (press and turn anticlockwise to remove) with a new bulb (press and turn clockwise to insert).
- Insert the bulb holder into the socket with the tab facing upwards and the grip horizontal. Press it against the socket and turn clockwise. When changing the bulb, you can check the position of the bulb through the headlight glass.
- Fit the rubber cap and tighten, making sure it fits properly into the headlight casing.
- Check whether the new bulb is working. ■

### Changing the xenon bulb

The procedure for changing the bulb is the same on both sides.



#### WARNING

This type of bulb should be changed at a specialised workshop. ■

## Changing tail light bulbs (on side panel)

### Overview of tail lights



Fig. 221 Overview of tail lights

#### Tail lights on side panel

- Brake lights and side lights
- Turn signal

### Overview of tail lights. LED lamps



Fig. 222 Overview of tail lights

#### Tail lights on side panel

- Brake lights and side lights
- Turn signal



#### Note

- It is only possible to change the turn signal light.
- If the warning lamp for the side light and/or rear fog light (LED lights) lights up, the tail light assembly should be replaced.
- The failure of the lamp is only shown when the LED function goes out completely. Sometimes, a LED will stop working, without displaying the warning as the function continues to operate.

## Removing the tail light

To change the bulbs you must remove the tail light assembly. Removing the light requires a certain degree of practical skill.

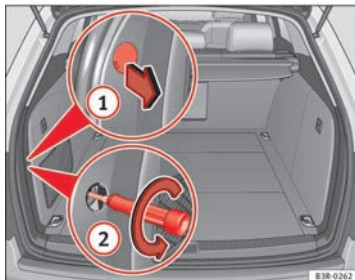

Fig. 223 Luggage compartment: Location of the bolt securing the tail light unit

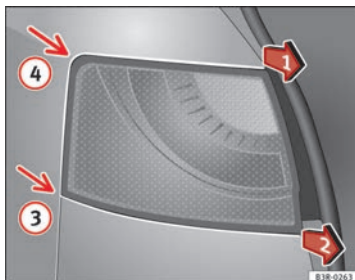

Fig. 224 Removing tail light from side panel

A special retaining screw is used to secure and guide the tail light.

- Check which of the bulbs is defective.
- Open the rear lid.
- Prise off the cover with a screwdriver in the slot ⇒ Fig. 223 ① and remove the cover (with all the retaining clips) from the opening.
- Carefully loosen the screw located behind the cover with a screwdriver, turning it anticlockwise (arrows) ②.
- Gradually ease the tail light out of the housing (⇒ Fig. 224 positions ③ and ④) by pulling alternately in positions ① and ②.
- Remove the bulb holder ⇒ page 285.

### ⚠ CAUTION

When removing or installing the tail light, take care not to cause any damage.

- Removing the tail light in particular can lead to the paintwork or tail light becoming damaged. This is another reason why we recommend having the bulbs changed by a specialised workshop.

### 📄 Note

Make sure you have a soft cloth ready to place under the glass on the tail light, to avoid any scratches. ■

## Remove the bulb holder

When changing a bulb, you must first remove the bulb holder.

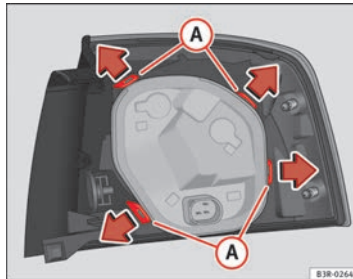

Fig. 225 Retaining tabs on reverse side of tail light

There are four securing tabs on the inside of the tail light unit.

- Release the retaining tabs (A) ⇒ Fig. 225.
- Lift the bulb carrier off in direction of the arrow (B).
- Change the defective bulb ⇒ page 285 ⇒ page 286.

### WARNING

If a bulb is replaced in a tail light assembly with LED, do not pull too hard on the bulb holder. This may damage the wiring of the LED module.

## Changing bulbs

All bulbs can be changed easily in the bulb holder.

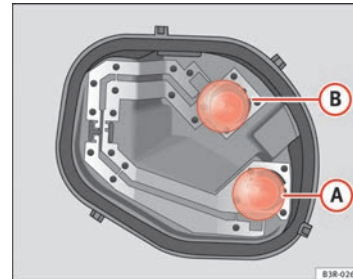

Fig. 226 Position of the bulbs in the bulb holder: Example: Outer left tail light

The bulbs are secured with a bayonet fastener. The table below gives an overview of the bulb positions.

- Lightly press the defective bulb into the bulb holder, then turn it to the left and remove it.
- Fit the new bulb, pressing it into the bulb holder and turn it to the right as far as it will go.
- Use a cloth to remove any fingerprints from the glass part of the bulb.
- Check whether the new bulb is working.
- Re-install the bulb holder ⇒ page 286.

**Position of the bulbs**

Pos. ⇒ Fig. 226	Bulb function	
A	Turn signal	P21W
B	Brake lights and side lights	P21W LL

**Changing bulbs. LED lamps**

All bulbs can be changed easily in the bulb holder.

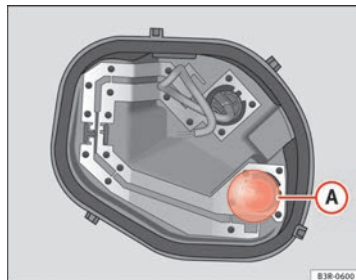

Fig. 227 Position of the bulbs in the bulb holder:  
Example: Outer left tail light

The bulb is secured with a bayonet fastening. The table below gives an overview of the bulb positions.

- Lightly press the defective bulb into the bulb holder, then turn it to the left and remove it.
- Fit the new bulb, pressing it into the bulb holder and turn it to the right as far as it will go.

- Use a cloth to remove any fingerprints from the glass part of the bulb.
- Check whether the new bulb is working.
- Re-install the bulb holder ⇒ page 286.

**Position of the bulbs**

Pos. ⇒ Fig. 227	Bulb function	
A	Turn signal	PY21W

**Fitting the bulb holder**

The bulb holder is easy to fit.

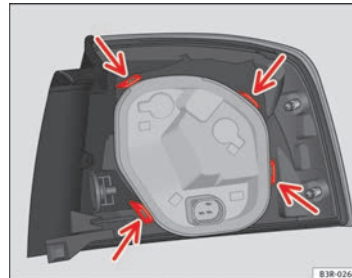

Fig. 228 Securing the bulb holder in the tail light unit

- Check that the seal is seated correctly on the bulb holder. ▶

- Position the bulb holder on the tail light and align it so that it is securely seated.
- Press the bulb holder into the tail light until it engages.
- Check that all four retaining tabs → Fig. 228 -arrows- have engaged.
- Re-install the tail light unit ⇒ page 287.

### Fitting the tail light unit

*The tail light unit is easy to fit.*

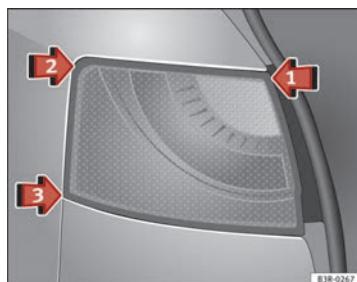

Fig. 229 Fitting the tail light unit

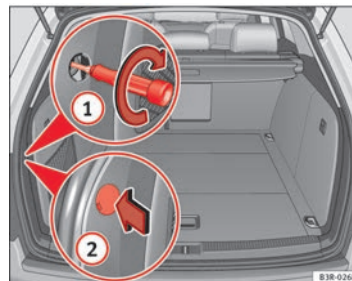

Fig. 230 Luggage compartment: Location of the bolt securing the tail light unit

- First place the tail light unit in ⇒ Fig. 229 arrow ① in the housing.
- Gently press the tail light unit against the housing, first in position ② and then in position ③, until that the clips engage firmly in the rubber mountings.
- Apply gentle pressure to the upper part of the tail light unit and secure using the screwdriver, from the luggage compartment ⇒ Fig. 230 ①.
- Try to move the tail light sideways to ensure it is correctly fitted.
- Fit the cover back onto the screw, with the notch pointing to the rear ②.
- Make sure that all bulbs for the tail lights are working. ▶

### ⚠ CAUTION

Take care when fitting the tail light unit to make sure there is no damage to the paintwork or any of its components.

## Changing tail light bulbs (on rear lid)

### Overview of tail lights



Fig. 231 Overview of tail lights

#### Tail lights on the rear lid

- Rear side lights
- Rear fog light
- Reverse lights

### Overview of tail lights. LED lamps



Fig. 232 Overview of tail lights

#### Tail lights on the rear lid

- Rear side lights
- Rear fog light
- Reverse lights

#### **i** Note

- It is only possible to replace the rear fog lamp and the reversing light.
- If the side light (LED lamp) gives signs of failing, the light should be replaced.
- The failure of the lamp is only shown when the LED function goes out completely. Sometimes, a LED will stop working, without displaying the warning as the function continues to operate.

## Remove the bulb holder

The rear lid must be open to change the bulbs.

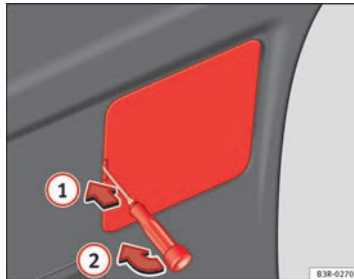

Fig. 233 Remove the cover of the rear lid trim

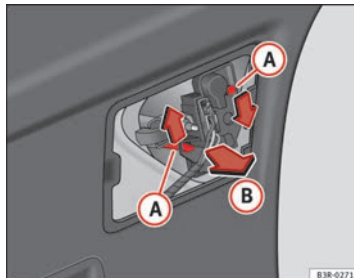

Fig. 234 Remove the bulb holder

You can access the bulb holder for the inner tail lights via the inside of the rear lid.

- Check which of the bulbs is defective.
- Insert the screwdriver into the opening in the cover ⇒ Fig. 233 ① and detach the cover ②.
- Press on the tabs (A) ⇒ Fig. 234 in the direction of the arrows and remove the bulb holder by pulling in the direction of the arrow (B).
- Change the bulbs ⇒ page 289 ⇒ page 290.

### ! WARNING

If a bulb is replaced in a tail light assembly with LED, do not pull too hard on the bulb holder. This may damage the wiring of the LED module.

## Changing bulbs

All bulbs can be changed easily in the bulb holder.

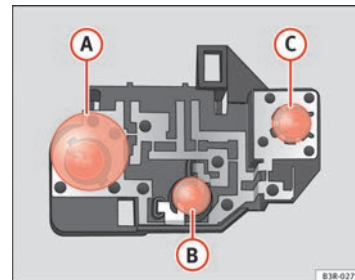

Fig. 235 Position of the bulbs in the bulb holder. Example: Tail lights on the rear lid

The bulbs are secured with a bayonet fastener. The table below gives an overview of the bulb positions.

- Lightly press the defective bulb into the bulb holder, then turn it to the left and remove it.
- Fit the new bulb, pressing it into the bulb holder and turn it to the right as far as it will go.
- Use a cloth to remove any fingerprints from the glass part of the bulb.
- Check whether the new bulb is working.
- Re-install the bulb holder ⇒ page 291.

#### Position of the bulbs

Pos. ⇒ Fig. 235	Bulb function	
A	Reverse lights	P21W LL
B	Rear side lights	W5W LL
C	Rear fog light	H21W

#### Changing bulbs. LED lamps

*All bulbs can be changed easily in the bulb holder.*

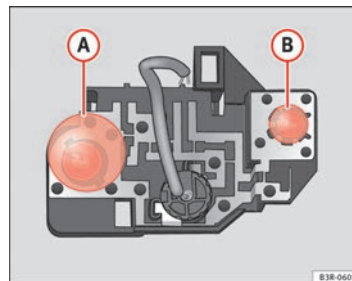

**Fig. 236** Position of the bulbs in the bulb holder. Example: Tail lights on the rear lid

The bulbs are secured with a bayonet fastener. The table below gives an overview of the bulb positions.

- Lightly press the defective bulb into the bulb holder, then turn it to the left and remove it.
- Fit the new bulb, pressing it into the bulb holder and turn it to the right as far as it will go.
- Use a cloth to remove any fingerprints from the glass part of the bulb.
- Check whether the new bulb is working.
- Re-install the bulb holder ⇒ page 291. ▶

## Position of the bulbs

Pos. ⇒ Fig. 235	Bulb function	
A	Reverse lights	P21W LL
B	Rear fog light	H21W

## Fitting the bulb holder

*The bulb holder is easy to fit.*

- Position the bulb holder on the tail light and align it so that it is securely seated.
- Press the bulb holder into the tail light until it engages.
- Fit the cover back in the interior trim so that it engages.
- Make sure that all bulbs for the tail lights are working.

## Side turn signals

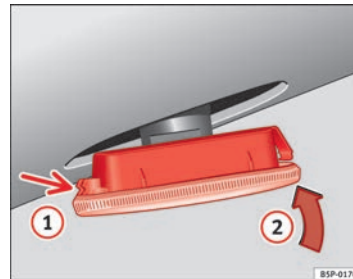

Fig. 237 Side turn signal

- Press the turn signal to the left or to the right to remove the bulb.
- Remove the bulb holder from the turn signal.
- Remove the failed glass bulb and replace with a new bulb.
- Insert the bulb holder in the turn signal guide until it clicks into place.
- First place the turn signal in the opening in the bodywork, fixing the tabs ⇒ Fig. 237, arrow ①.
- Insert the bulb as shown by the arrow ② ⇒ Fig. 237.

## Luggage compartment lights

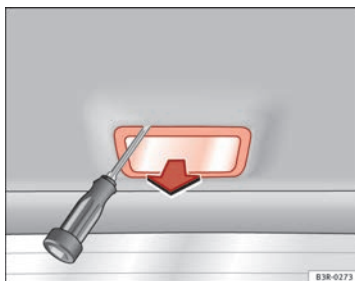

Fig. 238 Luggage compartment light

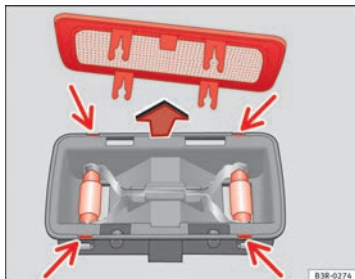

Fig. 239 Luggage compartment light

- Remove the tulip-shaped fitting by pressing on its inside edge using the flat side of a screwdriver.

- Remove the protective cover and remove the bulb from the housing. ■

## Registration light



Fig. 240 Number plate light

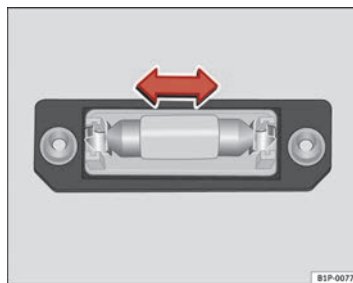

Fig. 241 Number plate light ▶

- To remove the light cover, unscrew the bolts ⇒ Fig. 240.
- Remove the bulb, moving it in the direction of the arrow and outwards ⇒ Fig. 241.
- Installation is done in the reverse order.

## Sun visor light

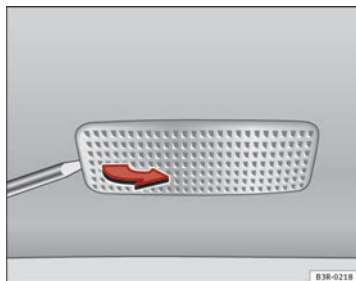

Fig. 242 Removing sun visor light

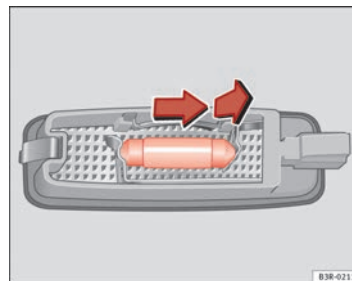

Fig. 243 Removing sun visor light

- Remove the bulb carefully, using the flat part of a screwdriver ⇒ Fig. 242.
- Use a screwdriver to remove the protective cover.
- Remove the bulb, moving it in the direction of the arrow and outwards ⇒ Fig. 243.

## Jump-starting

### Jump leads

*The jump lead must have a sufficient wire cross section.*

If the engine fails to start because of a discharged battery, the battery can be connected to the battery of another vehicle to start the engine. ▶

### Jump leads

Jump leads must comply with standard **DIN 72553** (see manufacturer's documentation). The wire cross section must be at least 25 mm<sup>2</sup> for petrol engines and at least 35 mm<sup>2</sup> for diesel engines.



#### Note

- The vehicles must not touch each other, otherwise electricity could flow as soon as the positive terminals are connected.
- The discharged battery must be properly connected to the vehicle electrical system.

### How to jump start: description

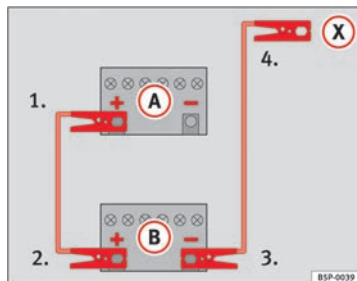

Fig. 244 Diagram of connections for vehicles without Start-Stop system

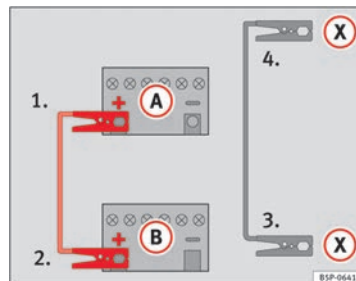

Fig. 245 Diagram of connections for vehicles with Start-Stop system

### Jump lead terminal connections

1. Switch off the ignition of both vehicles ⇒ ⚠.
2. **For vehicles without Start-Stop system:**
  - Connect one end of the **red** jump lead to the positive (+) terminal of the vehicle with the flat battery (A) ⇒ Fig. 244.
  - Connect the other end of the **red** jump lead to the positive terminal (+) in the vehicle providing assistance (B).
  - Connect one end of the **black** jump lead to the negative terminal (-) of the vehicle providing assistance (B) ⇒ Fig. 244.
  - Connect the other end of the **black** jump lead (X) to a solid metal component bolted to the engine block or to the engine block itself of the vehicle with the flat battery. However, connect it to a point as far as possible from the battery (A).
3. **For vehicles with Start-Stop system:** ▶

- Connect one end of the *red* jump lead to the positive (+) terminal of the vehicle with the flat battery (A) ⇒ Fig. 245.
  - Connect the other end of the *red* jump lead to the positive terminal (+) in the vehicle providing assistance (B).
  - Connect one end of the *black* jump lead (X) to a suitable ground terminal, a solid piece of metal in the engine block, or to the engine block ⇒ Fig. 245.
  - Connect the other end of the *black* jump lead (X) to a solid metal component bolted to the engine block or to the engine block itself of the vehicle with the flat battery. However, connect it to a point as far as possible from the battery (A).
4. Position the leads in such a way that they cannot come into contact with any moving parts in the engine compartment.

### Starting

5. Start the engine of the vehicle with the boosting battery and let it run at idling speed.
6. Start the engine of the vehicle with the flat battery and wait one or two minutes until the engine is running.

### Removing the jump leads

7. Before you remove the jump leads, switch off the headlights (if they are switched on).
8. Turn on the heater blower and heated rear window in the vehicle with the flat battery. This helps minimise voltage peaks which are generated when the leads are disconnected.
9. When the engine is running, disconnect the leads in reverse order to the details given above.

Connect the battery clamps so they have good metal-to-metal contact with the battery terminals.

If the engine fails to start, switch off the starter after about 10 seconds and try again after about half a minute.

### WARNING

- Please note the safety warnings referring to working in the engine compartment ⇒ page 234.
- The battery providing assistance must have the same voltage as the flat battery (12V) and approximately the same capacity (see imprint on battery). Failure to comply could result in an explosion.
- Never use jump leads when one of the batteries is frozen. Danger of explosion! Even after the battery has thawed, battery acid could leak and cause chemical burns. If a battery freezes, it should be replaced.
- Keep sparks, flames and lighted cigarettes away from batteries, danger of explosion. Failure to comply could result in an explosion.
- Observe the instructions provided by the manufacturer of the jump leads.
- Do not connect the negative cable from the other vehicle directly to the negative terminal of the flat battery. The gas emitted from the battery could be ignited by sparks. Danger of explosion.
- Do not attach the negative cable from the other vehicle to parts of the fuel system or to the brake line.
- The non-insulated parts of the battery clamps must not be allowed to touch. The jump lead attached to the positive battery terminal must not touch metal parts of the vehicle, this can cause a short circuit.
- Position the leads in such a way that they cannot come into contact with any moving parts in the engine compartment.
- Do not bend over the batteries. This could result in chemical burns. ▶

**Note**

The vehicles must not touch each other, otherwise electricity could flow as soon as the positive terminals are connected. ■

## Towing and tow-starting

### Tow-starting

*The use of jump leads is preferable to tow-starting.*

We recommend that you do **not** tow-start your vehicle. Jump-starting is preferable ⇒ page 293.

#### However, if your vehicle has to be tow-started:

- Engage the 2nd or the 3rd gear.
- Keep the clutch pressed down.
- Switch the ignition on.
- Once both vehicles are moving, release the clutch.
- As soon as the engine starts, press the clutch and move the gear lever into neutral. This helps to prevent driving into the towing vehicle.



#### WARNING

The risk of accidents is high when tow-starting. The vehicle being towed can easily collide with the towing vehicle.



#### CAUTION

When tow-starting, fuel could enter the catalytic converter and damage it. ■

### General notes

Please observe the following points if you use a tow rope:

#### Notes for the driver of the towing vehicle

- Drive slowly at first until the tow rope is taut. Then accelerate gradually.
- Begin and change gears cautiously. If you are driving an automatic vehicle, accelerate gently.
- Remember that the brake servo and power steering are not working in the vehicle you are towing. Brake sooner than normal and pressing the pedal gently.

#### Notes for the driver of the towed vehicle

- Ensure that the tow rope remains taut at all times when towing.

#### Tow rope or tow bar

It is easier and safer to tow a vehicle with a tow bar. You should only use a tow rope if you do not have a tow bar.

A tow rope should be slightly elastic to reduce the loading on both vehicles. It is advisable to use a tow rope made of synthetic fibre or similarly elastic material.

Attach the tow rope or the tow bar only to the towing eyes provided or a towing bracket.

#### Driving style

Towing requires some experience, especially when using a tow rope. Both drivers should be familiar with the technique required for towing. Inexperienced drivers should not attempt to tow. ▶

Do not pull too hard with the towing vehicle and take care to avoid jerking the tow rope. When towing on an unpaved road, there is always a risk of overloading and damaging the anchorage points.

The ignition of the vehicle being towed must be switched on to prevent the steering wheel from locking and also to allow the use of the turn signals, horn, windscreen wipers and washers.

As the brake servo does not work if the engine is not running, you must apply considerably more pressure to the brake pedal than you normally would.

As the power assisted steering does not work if the engine is not running, you will need more strength to steer than you normally would.

#### Towing vehicles with an automatic gearbox

- Put the selector lever into position “N”.
- Do not drive faster than 50 km/h.
- Do not tow further than 50 km.
- If a breakdown vehicle is used, the vehicle must be towed with the front wheels raised.



#### Note

- Observe legal requirements when towing or tow-starting.
- Switch on the hazard warning lights of both vehicles. However, observe any regulations to the contrary.
- For technical reasons, vehicles with an automatic gearbox must not be tow-started.
- If damage to your vehicle means that there is no lubricant in the gearbox, you must raise the drive wheels while the vehicle is being towed.
- If the vehicle has to be towed more than 50 km, the front wheels should be raised during towing, and towing should be carried out by a qualified person.

- The steering wheel is locked when the vehicle has no electrical power. The vehicle must then be towed with the front wheels raised. Towing should be carried out by a qualified person.
- The towing eye should always be kept in the vehicle. Please refer to the notes ⇒ page 297, Tow-starting. ■

#### Front towing eye



Fig. 246 Fitting the towing eye to front rear of the vehicle

#### Fitting the towing eye

- Take the towing ring from the on-board tool set.
- Remove the front cover by pressing down on the right hand side.
- Bolt the eye to its limit to the *left*, in the direction of the arrow ⇒ Fig. 246 ■

## Rear towing eye

---

There is a towing eye at the rear on the right below the rear bumper. ■

## Technical Specifications

### Description of specifications

#### Important information

##### Important

*The information in your vehicle's official documents always take precedence over the information in the current instruction manual.*

All technical specifications provided in this manual are valid for the standard model in Spain. The vehicle data card included in the Maintenance Programme or the vehicle registration documents shows which engine is installed in the vehicle.

The figures may be different depending on if additional equipment is fitted, for different models, for special vehicles and for other countries.

##### Abbreviations used in the Technical Specifications section

Abbreviation	Meaning
kW	Kilowatt, engine power measurement.
PS	Pferdestärke (horsepower), formerly used to denote engine power.
rpm	Revolutions per minute - engine speed.
Nm	Newton metres, unit of engine torque.
l/100 km	Fuel consumption in litres per 100 km.
g/km	Carbon dioxide emissions in grams per km travelled.
CO <sub>2</sub>	Carbon dioxide

Abbreviation	Meaning
CN	Cetane number, indication of the diesel combustion power.
RON	Research octane number, indication of the knock resistance of petrol.

## Vehicle identification data

The most important information is given on the identification plate and the vehicle data sticker.

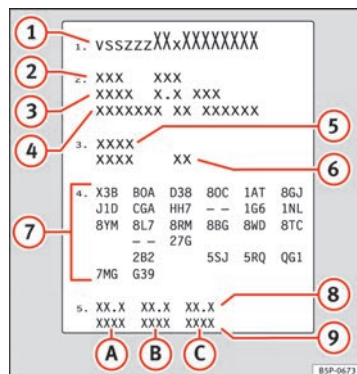

Fig. 247 Vehicle data sticker (luggage compartment)

Vehicles for certain export countries do not have an identification plate.

### Identification plate

The identification plate is located on the left rib inside the engine compartment.

### Vehicle identification number

The vehicle identification number (chassis number) can be read from outside the vehicle through a viewer in the windscreen. This is located on the left-hand side of the vehicle in the lower area of the windscreen. It is also located on the right hand side of the engine compartment.

### Vehicle data

The data sticker is placed on the inside of the spare wheel well, in the luggage compartment and on the rear cover of the Maintenance Programme.

The following information is provided on the vehicle data sticker: => Fig. 247

- 1 Production control number
- 2 Vehicle identification number (chassis number)
- 3 Model code number
- 4 Model designation / engine power output
- 5 Engine and gearbox code letters
- 6 Paintwork number / interior trim code
- 7 Optional equipment codes
- 8 Consumption values
- 9 CO<sub>2</sub> emissions values

At the end of the data sticker, in points 8 and 9, you can see the consumption and emission information.

### Information on consumption and emissions

- A Urban consumption (l/100 km)  
Urban CO<sub>2</sub> emissions (g/km)
- B Extra-urban consumption (l/100 km)  
Extra-urban CO<sub>2</sub> emissions (g/km)
- C Combined consumption (l/100 km)  
Combined CO<sub>2</sub> emissions (g/km)

## Information on fuel consumption

### Fuel consumption

*The consumption and emission details shown on the vehicle data sticker differ from one vehicle to another.*

The vehicle's fuel consumption and CO<sub>2</sub> emissions can be consulted on the vehicle data sticker in the spare wheel well, inside the luggage compartment and on the rear cover of the Maintenance Programme.

The fuel consumption and CO<sub>2</sub> emission values refer to the weight category assigned to your vehicle according to the engine and gearbox combination, as well as the specific equipment fitted, and is only used to compare between the different models.

The fuel consumption and CO<sub>2</sub> emissions do not depend only on the performance of the vehicle, they can also differ from the established values depending on other factors such as driving style, road conditions, traffic conditions, environmental conditions, load and number of passengers.

### Calculation of fuel consumption

The consumption values have been calculated based on measurements performed or supervised by certified CE laboratories according to the latest version of directives 715/2007/EC and 80/1268/CEE (for more information consult the European Union Publications Office at EUR-Lex: © European Union, <http://eur-lex.europa.eu/en/index.htm>) and are valid for the kerb weight indicated for the vehicle.



#### Note

In practice, and considering all the factors mentioned here, consumption values can differ from those calculated in the current European regulations. ■

## Weights

Kerb weight refers to the basic model with a fuel tank filled to 90% capacity and without optional extras. The figure quoted includes 75 kg to allow for the weight of the driver.

For special versions and optional equipment fittings or for the addition of accessories, the weight of the vehicle will increase ⇒ ⚠.



### WARNING

- Please note that the centre of gravity may shift when transporting heavy objects; this may affect the vehicle's handling and lead to an accident. Always adjust your speed and driving style to suit road conditions and requirements.
- Never exceed the gross axle weight rating or the gross vehicle weight rating. If the allowed axle load or the allowed total weight is exceeded, the driving characteristics of the vehicle may change, leading to accidents, injuries and damage to the vehicle. ■

## Towing a trailer

### Trailer weights

#### Trailer weight

The trailer weights and drawbar loads approved are selected in intensive trials according to precisely defined criteria. The approved trailer weights are valid for vehicles in the EU for maximum speeds of 80 km/h (in certain circumstances up to 100 km/h). The figures may be different in other countries. All data in the official vehicle documents take precedence over these data ⇒ ⚠. ▶

### Drawbar load

The *maximum* permitted drawbar load on the ball joint of the towing bracket must not exceed **75 kg**.

In the interest of road safety, we recommend that you always tow approaching the maximum drawbar load. The response of the trailer on the road will be poor if the drawbar load is too small.

If the maximum permissible drawbar load cannot be met (e.g. with small, empty and light-weight single axle trailers or tandem axle trailers with a wheelbase of less than 1 metre), a minimum of 4% of the actual trailer weight is legally required for the drawbar load.

#### WARNING

- For safety reasons, do not exceed the 80 km/h limit. This is also valid in countries where higher speeds are permitted.
- Never exceed the maximum trailer weights or the drawbar load. If the permissible axle load or the permissible total weight is exceeded, the driving characteristics of the vehicle may change, leading to accidents, injuries and damage to the vehicle.

Consult the chapter “wheels” of this manual.

### Wheel bolts

After the wheels have been changed, the **tightening torque** of the wheel bolts should be checked as soon as possible with a torque wrench ⇒ . The tightening torque for steel and alloy wheels is **120 Nm**.

#### WARNING

- Check the tyre pressure at least once per month. Checking the tyre pressure is very important. If the tyre pressure is too high or too low, there is an increased danger of accidents, particularly at high speeds.
- If the torque of the wheel bolts is too low, they could loosen while the vehicle is in motion. Risk of accident! If the tightening torque is too high, the wheel bolts and threads can be damaged.

#### Note

We recommend that you ask your Technical Service for information about appropriate wheel, tyre and snow chain size.

## Wheels

### Tyre pressure, snow chains, wheel bolts

#### Tyre pressures

The sticker with the tyre pressure values can be found on the inside of the tank flap. The tyre pressure values given there are for *cold* tyres. The slightly raised pressures of warm tyres must not be reduced. ⇒ 

#### Snow chains

Snow chains may be fitted only to the *front wheels*.

## Technical specifications

### Engine specifications

#### Checking fluid levels

*From time to time, the levels of the different fluids in the vehicle must be checked. Never fill with incorrect fluids, otherwise serious damage to the engine may be caused.*

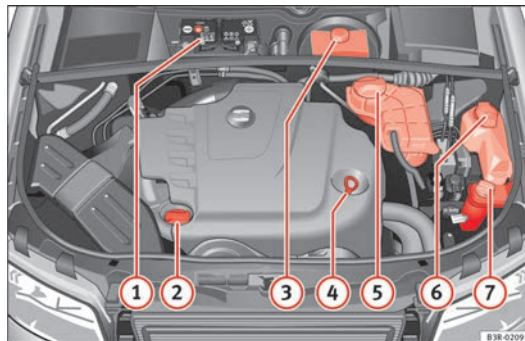

Fig. 248 Diagram for the location of the various elements

- ① Vehicle battery
- ② Engine oil filler cap
- ③ Brake fluid reservoir
- ④ Engine oil dipstick

- ⑤ Coolant expansion tank
- ⑥ Windscreen washer fluid container
- ⑦ Hydraulic fluid reservoir for power steering

The checking and refilling of service fluids are carried out on the components mentioned above. These operations are described in the ⇒ page 234.

#### Overview

You will find further explanations, instructions and restrictions on the technical specifications as of ⇒ page 300.



#### Note

The layout of parts may vary depending on the engine. ■

## Petrol engine 1.8 88 kW (120 PS)

### Engine specifications

Power output in kW (PS)	rpm	88 (120) / 3650-6200
Maximum torque	in Nm at rpm	230 / 1500-3650
No. of cylinders/capacity	in cm <sup>3</sup>	4 / 1798
Fuel		Super 95 RON <sup>a)</sup> / Super 91 RON <sup>b)</sup>

a) Research Octane Number = Anti-detonation rating of the petrol.

b) Slight power loss.

### Performance

Maximum speed	in km/h	196
Acceleration from 0-80 km/h	in sec.	7,3
Acceleration from 0-100 km/h	in sec.	11,1

### Weights

Gross vehicle weight	in kg	2040
Weight in running order (with driver)	in kg	1555
Gross front axle weight	in kg	1075
Gross rear axle weight	in kg	1090
Permitted roof load	in kg	75

### Trailer weight

Trailer without brakes	in kg	750
Trailer with brakes, gradients up to 8%	in kg	1500
Trailer with brakes, gradients up to 12%	in kg	1300

### Petrol engine 1.8 118 kW (160 PS)

#### Engine specifications

Power output in kW (PS)	rpm	118 (160) / 4500-6200
Maximum torque	in Nm at rpm	250 / 1500-4500
No. of cylinders/capacity	in cm <sup>3</sup>	4 / 1798
Fuel		Super 95 RON <sup>a)</sup> / Super 91 RON <sup>b)</sup>

a) Research Octane Number = Anti-detonation rating of the petrol.

b) Slight power loss.

#### Performance

Maximum speed	in km/h	218
Acceleration from 0-80 km/h	in sec.	6,1
Acceleration from 0-100 km/h	in sec.	8,9

#### Weights

Gross vehicle weight	in kg	2040
Weight in running order (with driver)	in kg	1555
Gross front axle weight	in kg	1075
Gross rear axle weight	in kg	1090
Permitted roof load	in kg	75

#### Trailer weight

Trailer without brakes	in kg	750
Trailer with brakes, gradients up to 8%	in kg	1500
Trailer with brakes, gradients up to 12%	in kg	1300

## Petrol engine 2.0 147 kW (200 PS)

### Engine specifications

Power output in kW (PS)	rpm	147 (200) / 5100-6000
Maximum torque	in Nm at rpm	280 / 1800-5000
No. of cylinders/capacity	in cm <sup>3</sup>	4 / 1984
Fuel		Super 98 RON <sup>a)</sup> /Super 95 RON <sup>b)</sup>

a) Research Octane Number = Anti-detonation rating of the petrol.

b) Slight power loss.

### Performance

Maximum speed	in km/h	230
Acceleration from 0-80 km/h	in sec.	5,4
Acceleration from 0-100 km/h	in sec.	7,6

### Weights

Gross vehicle weight	in kg	2075
Weight in running order (with driver)	in kg	1590
Gross front axle weight	in kg	1115
Gross rear axle weight	in kg	1090
Permitted roof load	in kg	75

### Trailer weight

Trailer without brakes	in kg	750
Trailer with brakes, gradients up to 8%	in kg	1700
Trailer with brakes, gradients up to 12%	in kg	1500

### Petrol engine 2.0 155 kW (211 PS)

#### Engine specifications

Power output in kW (PS)	rpm	155 (211) / 4600-6000
Maximum torque	in Nm at rpm	320 / 1500-4600
No. of cylinders/capacity	in cm <sup>3</sup>	4 / 1984
Fuel		Super 95 RON <sup>a)</sup> / Super 91 RON <sup>b)</sup>

a) Research Octane Number = Anti-detonation rating of the petrol.

b) Slight power loss.

#### Performance

Maximum speed	in km/h	239
Acceleration from 0-80 km/h	in sec.	5,4
Acceleration from 0-100 km/h	in sec.	7,3

#### Weights

Gross vehicle weight	in kg	2050
Weight in running order (with driver)	in kg	1565
Gross front axle weight	in kg	1090
Gross rear axle weight	in kg	1135
Permitted roof load	in kg	75

#### Trailer weight

Trailer without brakes	in kg	750
Trailer with brakes, gradients up to 8%	in kg	1700
Trailer with brakes, gradients up to 12%	in kg	1500

## Diesel engine 2.0 TDI CR 88 kW (120 PS)

### Engine specifications

Power output in kW (PS)	rpm	88 (120) / 4000
Maximum torque	in Nm at rpm	290 / 1750-2500
No. of cylinders/capacity	in cm <sup>3</sup>	4 / 1968
Fuel		Min, diesel acc. to DIN EN 590 51 CN <sup>a)</sup>

a) Cetane Number (cetane index) = Measure of the combustion power of the diesel

### Performance

Maximum speed	in km/h	196
Acceleration from 0-80 km/h	in sec.	7,5
Acceleration from 0-100 km/h	in sec.	10,9

### Weights

Gross vehicle weight	in kg	2050
Weight in running order (with driver)	in kg	1565
Gross front axle weight	in kg	1100
Gross rear axle weight	in kg	1105
Permitted roof load	in kg	75

### Trailer weight

Trailer without brakes	in kg	750
Trailer with brakes, gradients up to 8%	in kg	1500
Trailer with brakes, gradients up to 12%	in kg	1300

### Diesel engine 2.0 TDI CR 105 kW (143 PS)

#### Engine specifications

Power output in kW (PS)	rpm	105 (143) / 4200
Maximum torque	in Nm at rpm	320 / 1750-2500
No. of cylinders/capacity	in cm <sup>3</sup>	4 / 1968
Fuel		Min, diesel acc. to DIN EN 590 51 CN <sup>a)</sup>

<sup>a)</sup> Cetane Number (cetane index) = Measure of the combustion power of the diesel

#### Performance

		Manual	Automatic
Maximum speed	in km/h	209	201
Acceleration from 0-80 km/h	in sec.	6,5	6,4
Acceleration from 0-100 km/h	in sec.	9,6	9,6

#### Weights

		Manual	Automatic
Gross vehicle weight	in kg	2050	2090
Weight in running order (with driver)	in kg	1565	1605
Gross front axle weight	in kg	1100	1135
Gross rear axle weight	in kg	1105	1090
Permitted roof load	in kg	75	75

#### Trailer weight

		Manual	Automatic
Trailer without brakes	in kg	750	750
Trailer with brakes, gradients up to 8%	in kg	1800	1900
Trailer with brakes, gradients up to 12%	in kg	1400	1700

## Diesel engine 2.0 TDI CR 125 kW (170 PS)

### Engine specifications

Power output in kW (PS)	rpm	125 (170) / 4200
Maximum torque	in Nm at rpm	350 / 1750-2500
No. of cylinders/capacity	in cm <sup>3</sup>	4 / 1968
Fuel		Min, diesel acc. to DIN EN 590 51 CN <sup>a)</sup>

a) Cetane Number (cetane index) = Measure of the combustion power of the diesel

### Performance

Maximum speed	in km/h	224
Acceleration from 0-80 km/h	in sec.	6,1
Acceleration from 0-100 km/h	in sec.	8,6

### Weights

Gross vehicle weight	in kg	2075
Weight in running order (with driver)	in kg	1590
Gross front axle weight	in kg	1115
Gross rear axle weight	in kg	1135
Permitted roof load	in kg	75

### Trailer weight

Trailer without brakes	in kg	750
Trailer with brakes, gradients up to 8%	in kg	1800
Trailer with brakes, gradients up to 12%	in kg	1600

## Dimensions and capacities

Dimensions		
Length, width	4661-4741 <sup>a)</sup> mm/ 1772 mm	
Height at kerb weight	1454 mm with roof bars	
Front and rear projection	976 mm/ 1048-1123 <sup>a)</sup> mm	
Wheelbase	2642 mm	
Turning circle	11.2 m	
Track width <sup>b)</sup>	<b>Front</b>	<b>Rear</b>
	1522 mm	1523 mm
Capacities		
Fuel tank	70 l. Reserve 10 l.	
Windscreen washer fluid container with headlight washer	4.8 l.	
Tyre pressure		
<p><b>Summer-grade tyres:</b> The correct tyre pressure can be seen on the sticker on the inside of the tank flap.</p> <p><b>Winter tyres:</b> The pressure of these tyres is the same as the summer tyre pressure plus 0.2 bar.</p>		

<sup>a)</sup> With towing eye.

<sup>b)</sup> This data will change depending on the type of wheel rim.

# Index

## Numbers and Symbols

230 V socket ..... 157

## A

Accessories ..... 228  
 Towing ..... 208  
 Adaptive headlights ..... 123  
 Faulty ..... 84  
 Airbag  
 Warning lamp ..... 68  
 Airbag covers ..... 35  
 Airbag system ..... 29  
 Curtain airbags ..... 42  
 Front airbags ..... 33  
 Side airbags ..... 39  
 Warning lamp ..... 31  
 Air conditioner  
 2C-Climatronic ..... 162  
 Air distribution ..... 169  
 Air outlets ..... 169  
 Air purity sensor ..... 167  
 Air recirculation ..... 166  
 Air recirculation (automatic) ..... 167  
 Automatic mode ..... 165  
 Blower ..... 168  
 Controls ..... 164  
 Defrosting ..... 166  
 ECON Mode (economy) ..... 166

Economical use ..... 170  
 Key settings ..... 170  
 Solar-powered blower/sunroof ..... 170  
 Temperature selection ..... 165  
 Air duct  
 Fitting ..... 274, 281  
 Removing ..... 274, 280  
 Air purity sensor ..... 167  
 Alcantara ..... 224  
 Alternator  
 Warning lamp ..... 72  
 Ambient lighting ..... 126  
 Anti-lock brake system  
 How it works ..... 196  
 Anti-theft alarm system ..... 110  
 Interior monitoring ..... 111  
 Antifreeze ..... 238  
 Aquaplaning ..... 254  
 Armrest  
 Storage compartment in front armrest ... 143  
 Armrests  
 Adjusting the front armrest ..... 143  
 Ashtray  
 Front ..... 154  
 Rear ..... 155  
 ASR  
 How the system works ..... 197  
 Warning lamp ..... 71  
 Athermic windscreen ..... 229

Auto-check system ..... 78  
 Automatic car wash tunnel ..... 217  
 Automatic gearbox  
 Dynamic gear control programme ..... 191  
 Kick-down feature ..... 191  
 multitronic® ..... 187  
 Paddle levers (tiptronic mode) ..... 193  
 Safety interlock for ignition key ..... 173  
 Selector lever lock ..... 190  
 Selector lever positions ..... 189  
 Steering wheel with paddle levers ..... 193  
 tiptronic ..... 187  
 tiptronic mode ..... 192  
 Automatic headlight control ..... 117  
 Auxiliary heater ..... 171

## B

Battery ..... 245  
 Battery voltage ..... 84  
 Charging ..... 247  
 Disconnection ..... 246  
 Long periods of non-use ..... 245, 246  
 Replacing ..... 245, 246  
 Testing ..... 245  
 Winter operation ..... 245, 246  
 Bicycle rack  
 Towing ..... 208  
 Biodiesel ..... 232  
 Biodiesel fuel ..... 232

- Bonnet ..... 233
  - Closing ..... 235
  - Opening ..... 234
  - Releasing ..... 233
- Brake light
  - Failure control ..... 83
- Brake pads ..... 201
- Brakes ..... 201
  - Brake assist system ..... 196
  - Brake fluid ..... 244
  - Worn brake pads ..... 84
- Brake servo ..... 201
- Brake system
  - Brakes ..... 198
  - Brake servo ..... 198
  - Malfunction ..... 80
- Braking distance ..... 201
- Bulb change
  - general notes ..... 272
- C**
- Car care
  - Exterior ..... 217
- Catalytic converter ..... 202
- CCS ..... 183
- CD-ROM player ..... 150
- Central locking ..... 101
  - Manual locking ..... 105
  - Sunroof: opening and closing ..... 116
- Central locking system
  - Anti-theft security system ..... 103
  - Locking ..... 102
  - Locking and unlocking the vehicle from inside ..... 103
  - Opening and closing the windows ..... 114
  - Rear lid ..... 106
  - Security central locking ..... 104
  - Switch on the driver door ..... 103
  - Unlocking ..... 102
- Cetane number ..... 232
- Changing the main headlight bulb
  - Main headlight ..... 276
- Changing the main headlight bulbs
  - Dipped beam headlight ..... 277
- Changing the tail lights
  - Luggage compartment lights ..... 292
- Changing windscreen wiper blades ..... 242
- Chassis number ..... 301
- Checklist
  - Seat upholstery ..... 223
- Childproof lock
  - Rear doors ..... 107
- Child safety ..... 47
- Child safety seat
  - ISOFIX system ..... 53
- Child seat ..... 49
  - Categorisation in groups ..... 49
  - Group 1 ..... 50
  - Group 2 ..... 50
  - Group 3 ..... 50
  - Groups 0 and 0+ ..... 49
- Safety notes ..... 47
  - Securing ..... 52
- Child seats
  - on the front passenger seat ..... 30
- Cigarette lighter ..... 155
- Cleaning alloy wheel rims ..... 221
- Cleaning chrome ..... 220
- Cleaning engine compartment ..... 222
- Cleaning steel wheel rims ..... 220
- Cleaning windows ..... 219
- Clock, setting ..... 63
- Coat hooks ..... 160
- Cockpit ..... 59
  - Overview ..... 59
- Compartments ..... 159
  - In the door trim ..... 160
  - In the front seats ..... 161
- Coolant
  - Checking the level ..... 239
- Coolant fluid
  - Topping up ..... 240
- Cooling system
  - Coolant temperature gauge ..... 62
  - Malfunction ..... 81
- Correct adjustment of front seat head restraints ..... 13
- Correct adjustment of rear seat head restraints
  - In-use and non-use positions ..... 14
- Correct sitting position
  - Front passenger ..... 12
  - Incorrect sitting position ..... 14

- Cruise control system ..... 183
- Adjust the stored speed ..... 185
  - Deactivating ..... 186
  - Deactivating temporarily ..... 185
  - Setting the speed ..... 184
- Cruise speed ..... 183
- Curtain airbags ..... 42
- Description ..... 42
  - Operation ..... 43
  - Safety notes ..... 43
- ## D
- Danger of fitting a child seat on the front passenger seat ..... 30
- Dash panel cleaning ..... 226
- Data entry control ..... 92
- Date display ..... 63
- Daytime running lights ..... 122
- Deactivating front passenger airbag
- Safety notes ..... 46
- Deactivating the airbag
- Front passenger airbag ..... 45
- Diesel ..... 232
- Diesel engine
- Winter driving ..... 233
- Diesel engine particulate filter ..... 203
- Diesel particulate filter ..... 83
- Engine oil ..... 235
- Digital clock ..... 63
- Dipped beam headlights ..... 117
- DIS
- Average fuel consumption ..... 88
  - Average speed ..... 88
  - Driving time ..... 88
  - Instantaneous fuel consumption ..... 88
- Disposal
- Airbags ..... 31
  - Seat belt tensioners ..... 28
- Distance covered ..... 89
- Distance to empty ..... 76, 88
- Door and rear lid warning ..... 77
- Door lock cylinders ..... 220
- Doors
- Childproof lock ..... 107
  - Locking the doors manually if the central locking fails to work ..... 105
- Driver
- see* Correct sitting position ..... 10, 11, 12
- Driver information system ..... 74
- Auto-check system ..... 78
  - CD and radio display ..... 75
  - Door and rear lid warning ..... 77
  - Driver messages ..... 79
  - Handbrake warning ..... 79
  - Menu display ..... 91
  - Onboard computer ..... 88
  - Outside temperature display ..... 75
  - Red symbols ..... 80
  - Speed warning ..... 85
  - Warning messages ..... 79
  - Yellow symbols ..... 82
- Driver messages ..... 79
- driver seat
- Assigning the key to the seat ..... 141
- Driver seat
- Activating stored settings ..... 140
  - With memory ..... 139
- Driving
- Driving abroad ..... 205
  - Economically / Environmentally friendly ..... 203
  - Driving abroad ..... 205
  - Headlights ..... 205
  - Driving safety ..... 9
- DRP
- see* Dynamic gear control programme ..... 191
- Dynamic gear control programme ..... 191
- ## E
- Economical driving ..... 203
- Electric socket ..... 156
- Electric windows ..... 112
- Central locking system ..... 114
  - Possible malfunctions ..... 114
  - Rear doors ..... 113
  - Switches on the driver door ..... 112
  - Switch on front passenger's door ..... 113
- Electronic differential lock
- How it works ..... 197
- Electronic immobiliser ..... 101
- Electronic Stability Control ..... 71
- description ..... 172
  - Operation ..... 195
  - warning lamp ..... 173

- Emergencies
- Changing a wheel ..... 262
  - Disconnecting the battery ..... 246
  - Jack ..... 259, 264
  - Sunroof emergency activation ..... 116
  - Tools ..... 259
  - Tyre mobility system ..... 260
- Engine
- Running in ..... 201
  - Starting ..... 174
  - Stop ..... 175
- Engine compartment
- Safety instructions ..... 234
- Engine coolant
- G 12 plus-plus ..... 238
  - G 13 ..... 238
  - Specifications ..... 238
- Engine oil ..... 235
- Checking oil level ..... 237
  - Checking the level ..... 83
  - Consumption ..... 237
  - Engine oil pressure too low ..... 81
  - Oil properties ..... 236
  - Oil sensor defective ..... 83
  - Topping up ..... 238
- Engine speed governing ..... 83
- Environment ..... 203
- Environmental friendliness ..... 205
  - Roof racks ..... 153
- Environmentally friendly driving ..... 203
- Environmental tip
- Avoiding pollution ..... 231
- ESC ..... 71
- see also* Electronic Stability Control ..... 172
- Exhaust gas purification system ..... 202
- Exterior mirrors ..... 219
- ## F
- Fastening rings ..... 17
- Floor mats ..... 16
- Fog lights ..... 119
- Front airbags ..... 33
- Description ..... 33
  - Operation ..... 34
  - Safety notes ..... 36
- Front drink holder ..... 153
- Front passenger airbag deactivation ..... 45
- Fuel
- Diesel ..... 232
  - Fuel gauge ..... 65
  - Fuel level low ..... 83
  - Instantaneous fuel consumption ..... 88
  - Petrol ..... 231
  - Fuel consumption ..... 203, 301
- Fuel tank
- opening the fuel tank flap ..... 230
- Fuel: save ..... 203
- Fuse
- Assignment ..... 271
  - Changing ..... 270
- ## G
- Gear display ..... 76
- Gear shift pattern ..... 186
- General overview of the engine compartment 304
- Glove compartment ..... 159
- Light ..... 125
- ## H
- Handbrake ..... 179
- Control lamp ..... 72
- Hazard warning lights ..... 123
- Headlight range control ..... 121
- Dynamic ..... 122
  - Faulty ..... 84
- Headlights
- Adaptive headlights ..... 123
  - Automatic headlight control ..... 118
  - Automatic headlight control photosensors 118
  - Driving abroad ..... 205
  - Front fog lights ..... 119
  - Headlight range control ..... 121
  - Headlight washer system ..... 132
- Head restraint
- Rear seat ..... 142
- Head restraints
- Front seats ..... 141
  - Rear seats ..... 142
  - Removing and fitting ..... 141
- Heated
- Seats ..... 171
- Heated rear window ..... 128

- Heated seats ..... 171
- High pressure cleaners ..... 218
- Horn ..... 59
- How to jump start description ..... 294
- I**
- Identification number ..... 301
- Identification plate ..... 301
- Ignition key  
  Safety interlock ..... 173
- Ignition lock ..... 173
- Indicator lamps  
  Glow plug system ..... 72  
  Main beam headlights ..... 72
- Indicator lamps - overview ..... 67
- Instruments  
  Lighting ..... 64, 121
- Interior lights  
  Ambient lighting ..... 126  
  Front ..... 125  
  Luggage compartment ..... 127  
  Rear ..... 127
- Interior mirror  
  With manual anti-dazzle setting ..... 132
- Interior monitoring ..... 111
- Intermittent wipe ..... 129
- ISOFIX ..... 53
- J**
- Jack ..... 259, 264
- Jump-starting ..... 293
- Jump leads ..... 293
- K**
- Keys ..... 99  
  Air conditioner settings ..... 170  
  Battery ..... 100  
  Remote control key ..... 108  
  Settings for the driver seat ..... 141
- Kick-down feature ..... 191
- L**
- Lamps  
  Cruise speed ..... 69
- Lighting  
  Instruments ..... 64, 121
- Lights  
  Adaptive headlights ..... 123  
  Automatic headlight control ..... 117  
  Coming home function ..... 119  
  Cornering light ..... 123  
  Dipped beam headlights faulty ..... 85  
  Dynamic headlight range control ..... 122  
  Headlight flasher ..... 125  
  Leaving home function ..... 119  
  Parking light ..... 125  
  Reverse lights faulty ..... 85  
  Switching on and off ..... 117  
  Xenon lights ..... 122
- Load compartment in the luggage compartment  
  see Loading the luggage compartment ... 16
- Loading the luggage compartment ..... 16
- Locking the doors manually if the central locking fails to work  
  Locking the doors manually if the central locking fails to work ..... 105
- Locks ..... 220
- Long periods of non-use  
  Battery ..... 245
- Luggage compartment ..... 144  
  Cover ..... 146  
  Extending ..... 150  
  Fastening rings ..... 145  
  Light ..... 127  
  Loading ..... 144  
  Luggage compartment liner ..... 149  
  Luggage net ..... 145  
  Net partition ..... 147  
  Retaining strap ..... 146  
  Side storage compartment ..... 150  
  Ski bag ..... 151  
  see also Loading the luggage compartment 16
- Luggage compartment cover  
  Removing ..... 148
- M**
- Main beam headlights ..... 117, 124
- Maintenance  
  Airbags ..... 31  
  Maintenance and cleaning ..... 216

Manual gearbox .....	186
Mirrors	
Activating stored settings .....	140
Automatic exterior mirror adjustment .....	139
Heated exterior mirrors .....	133
Storing settings .....	140
Vanity mirrors .....	128
Mobile phones and two-way radios .....	229
multitronic® .....	187
Driving .....	188

## N

Net partition	
Removing .....	148
Number of seats .....	19

## O

Observations .....	205
Octane number .....	231
Odometer .....	65
Oil consumption .....	237
Oil dipstick .....	237
Oil properties .....	236
Onboard computer .....	88
Outside temperature display .....	75
Overview	
Cockpit .....	59

## P

Paddle levers	
tiptronic .....	193
Paintwork	
Polishing .....	219
Parking .....	180
multitronic® .....	188
Parking aid	
SEAT Parking System .....	181
SEAT Parking System plus .....	182
Parking aid acoustic system .....	181
Passenger	
<i>see</i> Correct sitting position .....	10, 11, 12
Pedals .....	16
Petrol .....	231
Driving abroad .....	205
Petrol additives .....	232
Photosensor faulty .....	84
Physical principles of a frontal collision .....	20
Plastic parts .....	219
Plastic parts cleaning .....	226
Power socket .....	155
Power steering .....	199
Products for vehicle maintenance .....	216

## Q

Quartz clock .....	63
--------------------	----

## R

Radiator fan .....	240
Radio display .....	75
Rain sensor .....	129
Rain sensor faulty .....	84
Reading lights	
Front .....	125
Rear .....	127
Rear drink holder .....	154
Rear fog light .....	119
Rear lid	
Central locking system .....	106
Light .....	127
Rear seat bench .....	150
Rear side window sun blind .....	129
Rear view mirrors	
Anti-dazzle interior mirror with automatic adjustment .....	132
Anti-dazzle setting .....	132
Interior mirror .....	132
Rear window heating	
Heating element wires .....	220
Rear window sun blind .....	129
Rear window wiper	
Intermittent wipe .....	131
Rear window automatic wash and wipe ..	131
Refuelling .....	230
Registration light .....	292
Remote control key	
Indicator light .....	100
Locking and unlocking .....	108

- Locking and unlocking the vehicle ..... 108
  - Replacing the battery ..... 100
  - Remote control keys ..... 99
  - Re-synchronising ..... 109
  - Removing and fitting the wheel ..... 265
  - Repairs
    - Airbags ..... 31
  - Replacement of parts ..... 228
  - Rev counter ..... 63
  - Reverse gear
    - Automatic gearbox ..... 189
    - Manual gearbox ..... 186
  - Roof rack ..... 152
    - Attachment points ..... 152
    - Roof load ..... 153
  - Roof rails ..... 152
  - Rubber seals ..... 220
  - Run-flat tyres ..... 254
  - Running in
    - Engine ..... 201
- S**
- SAFE ..... 101
  - Safe driving ..... 7
    - Aspects to take into account ..... 8
    - Before setting off ..... 8
    - Driving safety ..... 8
  - Safety ..... 9
  - Safety equipment ..... 7
  - Safety instructions
    - Engine compartment ..... 234
  - Safety notes
    - Airbags ..... 31
    - Curtain airbags ..... 43
    - Deactivating front passenger airbag ..... 46
    - Front airbags ..... 36
    - Seat belt tensioners ..... 28
    - Side airbags ..... 41
    - Using child seats ..... 47
    - Using seat belts ..... 22
  - Seats ..... 220
    - Seat adjustment
      - Lumbar support ..... 138
    - Seat belt cleaning ..... 226
    - Seat belt position
      - Pregnant women ..... 26
      - Seat belts ..... 25
    - Seat belt protection ..... 22
    - Seat belt release ..... 26
    - Seat belts ..... 19
      - Adjustment ..... 24
      - Height adjustment ..... 27
      - Incorrectly fastened ..... 27
      - Not worn ..... 21
      - Safety notes ..... 22
      - Warning lamp ..... 19, 70
    - Seat belt tensioner
      - Warning lamp ..... 31
    - Seat belt tensioners ..... 28
    - Seat belt warning lamp ..... 19
    - Seat heating ..... 171
  - Seats
    - Electric adjustment ..... 137
    - Electric backrest adjustment ..... 138
    - Manual adjustment ..... 135
    - Manual adjustment of lumbar support ... 136
    - Manual backrest angle adjustment ..... 136
    - Moving the seat forwards and backwards 135
    - Seat height adjustment ..... 135
  - Seat upholstery
    - Alcantara ..... 224
    - Checklist ..... 223
    - cleaning Alcantara ..... 224
    - Cleaning and maintenance of natural leather ..... 225
    - cleaning the trim fabric ..... 224
    - synthetic leather ..... 226
  - Selector lever positions ..... 189
  - Service indicator ..... 77
  - Servotronic ..... 200
  - Side airbags ..... 39
    - Description ..... 39
    - Operation ..... 40
    - Safety notes ..... 41
  - Side lights ..... 117
  - Sitting position
    - Driver ..... 10
    - Front passenger ..... 11
  - Sitting position, occupants ..... 10
  - Ski bag ..... 151
  - Sliding/tilting sunroof ..... 114
    - Automatic close function ..... 116
    - Closing ..... 115

- Emergency activation ..... 116  
 Opening ..... 115  
 Snow chains ..... 258, 303  
 Solar-powered blower/sunroof ..... 170  
 Solar sunroof ..... 116  
 Spare keys ..... 99  
 Spare parts ..... 228  
 Spare wheel  
   Steel rim ..... 261  
 Speedometer ..... 65  
 Speed warning ..... 84, 85  
 Speed warning function ..... 85  
 Start-Stop  
   Activating and deactivating ..... 177  
   Function ..... 176  
 Steam jets ..... 218  
 Steering  
   Locking ..... 173  
   Manual steering wheel adjustment ..... 172  
 Steering wheel controls ..... 94  
 Stopping the engine ..... 175  
 Sun visors ..... 128  
 Switches on the driver door  
   Electric windows ..... 112  
 Symbols  
   Red symbols in central display ..... 80  
   Yellow symbols on central display ..... 82
- T**
- Technical modifications ..... 228  
 The danger of not using the seat belt ..... 21
- The environment  
   Heated rear window ..... 128  
   Leaks ..... 235  
   Warming up the engine ..... 174  
 Tightening torque of wheel bolts ..... 303  
 tiptronic ..... 187  
 tiptronic mode ..... 192  
 Tools ..... 259  
 Tow-starting ..... 297  
 Towing ..... 206, 297  
   Accessories ..... 208  
   Notes on towing ..... 206, 207  
   Removable towing bracket ..... 209  
   Technical requirements ..... 206  
 Towing a trailer ..... 302  
 Towing bracket, fitting ..... 214  
 Towing eye ..... 297  
 Towing eyes ..... 298  
 Tow starting  
   General notes ..... 297  
 Traction control system  
   How the system works ..... 197  
 Traction control system (ASR)  
   warning lamp ..... 71  
 Trailer weights ..... 302  
 Trip recorder ..... 65  
 Turn signal lamps  
   Hazard warning lights ..... 71  
   Trailer turn signals ..... 69  
   Turn signals ..... 71  
 Turn signals ..... 124  
 Tyre mobility system ..... 260  
 Tyre Mobility System ..... 266  
 Tyre pressure ..... 69, 93, 249  
   Loss ..... 251  
 Tyre pressure monitoring ..... 250  
 Tyre pressure monitoring system ..... 92  
 Tyre pressures ..... 303  
 Tyre repair kit  
   Tyre Mobility System ..... 266  
 Tyres and wheels  
   Dimensions ..... 255  
 Tyres service life ..... 253  
 Tyres tread depth ..... 253  
 Tyres with directional tread pattern ..... 249
- U**
- Underbody protection ..... 221  
 Upholstery  
   Treating your upholstery ..... 223
- V**
- Vehicle care  
   synthetic leather ..... 226  
   Treating your upholstery ..... 223  
 Vehicle data ..... 301  
 Vehicle identification data ..... 301  
 Vehicle identification number ..... 301  
 Vehicle keys ..... 99  
 Vehicle maintenance  
   electrically adjustable seats ..... 224  
   heated seats ..... 224

natural leather	225	Wear indicators	253
non-electrically adjustable seats	224	Wearing suitable shoes	16
seats with airbag components	224	Wheel bolts	303
seats without airbag components	224	Tightening torque	256
trim fabrics	224	Wheels	249, 303
unheated seats	224	Changing a wheel	262
Vehicle modifications	228	Why assume the correct sitting position?	29
Vehicle paintwork		Why should head restraints be correctly adjusted?	13
Maintenance	218	Why wear seat belts?	19, 20, 29
Products for vehicle maintenance	216	Windows	
Vehicle washing	217	Defrosting	166
Ventilation slits	17	Windscreen washer system	241
		Windscreen wiper blades	
		Cleaning	220
		Windscreen wipers	129
		Changing blades	242
		Changing the rear wiper blade	243
		Rain sensor	129
		Washer jets	129
		Winter	
		Battery	245
		Winter conditions	
		Defrost function	166
		Winter driving	
		Diesel engine	233
		Winter operation	
		Battery	246
		Winter tyres	257
		Wiper and washer system	129
		Wooden trim cleaning	226
Warning lamp	31		
Alternator	72		
Warning lamps			
Airbag	68		
Anti-lock brake system	70		
Electronic differential lock	70		
Engine management (EPC)	72		
Exhaust emission control system	68		
Handbrake	73		
Red symbols in central display	80		
Seat belt warning lamp	70		
Yellow symbols on central display	82		
Warning lamps - overview	67		
Washer fluid level	84		
Washing by hand	217		
Washing the vehicle	217		
Washing with high pressure cleaners	218		

## W

SEAT S.A. is permanently concerned about continuous development of its types and models. For this reason we ask you to understand, that at any given time, changes regarding shape, equipment and technique may take place on the car delivered. For this reason no right at all may derive based on the data, drawings and descriptions in this current handbook.

All texts, illustrations and standards in this handbook are based on the status of information at the time of printing. Except for error or omission, the information included in the current handbook is valid as of the date of closing print.

Re-printing, copying or translating, whether total or partial is not allowed unless SEAT allows it in written form.

SEAT reserves all rights in accordance with the "Copyright" Act.

All rights on changes are reserved.

 This paper has been manufactured using bleached non-chlorine cellulose.

© SEAT S.A. - Reprint: 15.07.12

Inglés 3R9012003CE (07.12) (GT9)



3R9012003CE

