

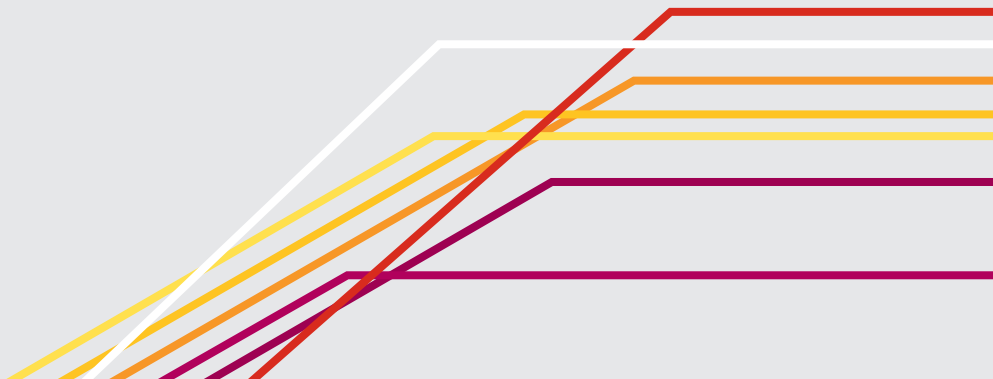

ALTEA

Owner's manual





Foreword

This Instruction Manual and its corresponding supplements should be read carefully to familiarise yourself with your vehicle.

Besides the regular care and maintenance of the vehicle, its correct handling will help preserve its value.

For safety reasons, always note the information concerning accessories, modifications and part replacements.

If selling the vehicle, give all of the on-board documentation to the new owner, as it should be kept with the vehicle.



Table of Contents

Manual structure	5	Operating Instructions	55	First-aid kit, warning triangle, fire extinguisher ..	153
Content	6	Cockpit	55	Luggage compartment	154
Safety First	7	Overview	55	Air conditioning	157
Brief introduction	7	Instruments	57	Heating	157
Proper sitting position for occupants	10	LPG system*	60	Climatic*	159
Pedal area	16	Digital instrument panel display	61	2C-Climatronic*	162
Storing objects	17	Instrument panel menus*	68	General notes	167
Seat belts	19	Warning lamps	77	Driving	169
Brief introduction	19	Steering wheel controls	91	Steering	169
Why wear seat belts?	21	General information	91	Safety	170
Seat belts	25	Audio system	92	Ignition lock	171
Seat belt tensioners	29	Radio navigation system	95	Starting and stopping the engine	172
Airbag system	30	Opening and closing	97	Start-Stop function*	176
Brief introduction	30	Central locking	97	Manual gearbox	179
Front airbags	34	Keys	103	Automatic gearbox/DSG automatic gearbox* ..	180
Side airbags*	38	Radio frequency remote control	105	Handbrake	185
Curtain airbags	41	Anti-theft alarm system*	107	Parking aid acoustic system*	187
Deactivating airbags*	44	Rear lid	109	Cruise speed* (Cruise control system)	190
Child safety	46	Windows	111	Practical Tips	194
Brief introduction	46	Sliding/tilting sunroof*	113	Intelligent technology	194
Child seats	48	Lights and visibility	116	Brakes	194
Securing child seats	51	Lights	116	Anti-lock brake and traction control systems M-	
		Interior lights	124	ABS (ABS and ASR)	195
		Visibility	127	Electronic Stability Control (ESC)*	196
		Windscreen wipers	128	Driving and the environment	202
		Rear vision mirrors	132	Running-in	202
		Seats and storage	135	Exhaust gas purification system	203
		The importance of correct seat adjustment	135	Economical and environmentally friendly driving	204
		Head restraints	136	Driving abroad	206
		Front seats	138		
		Rear seats	140		
		Storage compartment	142		
		Ashtray*, cigarette lighter* and power sockets ..	150		

Trailer towing	208	Technical Specifications	287
Instructions to follow	208	Description of specifications	287
Ball coupling of towing bracket*	209	Important information	287
Driving tips	209	Information on fuel consumption	289
Fitting a towing bracket*	210	Towing a trailer	289
Vehicle maintenance and cleaning	212	Wheels	290
General notes	212	Technical specifications	291
Care of the vehicle exterior	213	Checking fluid levels	291
Vehicle interior maintenance	218	Petrol engine 1.4 63 kW (85 PS)	292
Accessories, replacement of parts and modifications	224	Petrol engine 1.6 75 kW (102 PS)	293
Accessories and spare parts	224	Petrol engine 1.2 77 kW (105 PS)	294
Technical modifications	224	Petrol engine 1.4 92 kW (125 PS)	295
Roof aerial*	225	Petrol engine 1.8 118 kW (160 PS)	296
Mobile phones and two-way radios	225	Diesel engine 1.6 TDI CR 66 kW (90 PS) with/ without DPF	297
Checking and refilling levels	226	Diesel engine 1.6 TDI CR 77 kW (105 PS) with/ without DPF	298
Refuelling	226	Diesel engine 1.6 TDI CR 77 kW (105 PS) DPF	299
LPG system*	228	Start-Stop	300
Petrol	231	Diesel engine 2.0 TDI CR 103 kW (140 PS)	300
Diesel	232	Dimensions and capacities	302
Working in the engine compartment	233		
Engine oil	236		
Coolant	240		
Washer fluid and windscreen wiper blades	242		
Brake fluid	245		
Vehicle battery	247		
Wheels and tyres	250	Index	303
Wheels	250		
If and when	259		
Vehicle tools, tyre repair kit and spare wheel	259		
Wheel change	261		
Tyre repair kit (Tyre-Mobility-System)*	266		
Fuses	268		
Bulb change	272		
Jump-starting	281		
Towing and tow-starting	284		

Manual structure

What you should know before reading this manual

This manual contains a description of the **equipment** supplied with the vehicle at the time of press. Some of the equipment hereunder described will not be available until a later date, or is only available in certain markets.

Because this is a general manual for the ALTEA, some of the equipment and functions that are described in this manual are not included in all types or variants of the model or model year; they may vary or be modified depending on the technical requirements and on the market; this is in no way deceptive advertising.

The **illustrations** are intended as a general guide and may vary from the equipment fitted in your vehicle in some details.

The **direction indications** (left, right, front, rear) appearing in this manual refer to the normal forward working direction of the vehicle except when otherwise indicated.

The **equipment marked with an asterisk**** is fitted as standard only in certain versions, and is only supplied as optional extras for some versions, or are only offered in certain countries.

- Ⓢ All registered marks are indicated with Ⓢ. Although the copyright symbol does not appear, it is a copyrighted mark.
- ▶ The section is continued on the following page.
- Marks the **end of a section**.



WARNING

Texts preceded by this symbol contain information on safety. They warn you about possible dangers of accident or injury.



CAUTION

Texts with this symbol draw your attention to potential sources of damage to your vehicle.



For the sake of the environment

Texts preceded by this symbol contain relevant information concerning environmental protection.



Note

Texts preceded by this symbol contain additional information. ■

Content

This manual is structured to provide the information you need in an organised way. The content of this Manual is divided into **sections** which belong to **chapters** (e.g. "Air conditioning"). The entire manual is divided into five large parts which are:

1. Safety First

Information about the vehicle equipment relating to passive safety such as seat belts, airbags, seats, etc.

2. Operating instructions

Information about the distribution of controls in the driver position of your vehicle, about the seat adjustment possibilities, about how to create a suitable climate in the vehicle interior, etc.

3. Practical Tips

Advice relating to the driving, caring and maintenance of your vehicle and certain problems you can solve yourself.

4. Technical specifications

Figures, values and the dimensions of your vehicle.

5. Alphabetic index

At the end of this manual there is a detailed alphabetical index, this will help you to quickly find the information you require. ■

Safety First

Safe driving

Brief introduction

Dear SEAT Driver

Safety first!

This chapter contains important information, tips, suggestions and warnings that you should read and consider for both your own safety and for your passengers' safety.



WARNING

- This manual contains important information about the operation of the vehicle, both for the driver and the passengers. The other sections of the on-board documentation also contain further information that you should be aware of for your own safety and for the safety of your passengers.
- Ensure that the on-board documentation is kept in the vehicle at all times. This is especially important when lending or selling the vehicle to another person.

Safety equipment

The safety equipment is a part of the occupant protection system and can reduce the risk of injury in the event of an accident.

Never put your safety or the safety of your passengers in danger. In the event of an accident, the safety equipment may reduce the risk of injury. The following list includes most of the safety equipment in your SEAT:

- Three-point seat belts
- Belt tension limiters for the front and rear side seats
- Belt tensioners for the front seats
- Belt height adjustment for the front seats
- Front airbags
- Side airbags in the front seat backrests
- Curtain airbags
- Active front head restraints*
- ISOFIX anchorage points for child seats in the rear side seats with the ISOFIX system
- Height-adjustable front head restraints
- Head restraints with in-use position and non-use position
- Adjustable steering column

The safety equipment mentioned above works together to provide you and your passengers with the best possible protection in the event of an accident. However, these safety systems can only be effective if you and your

passengers are sitting in a correct position and use this equipment properly.

Therefore, information is provided about why this equipment is so important, how it protects you, what you have to consider when using it and how you and your passengers can achieve the greatest possible benefit from the safety equipment fitted. This manual includes important warnings that you and your passengers should note in order to reduce the risk of injury.

Safety is everyone's business!

Before setting off

The driver is always responsible for the safety of the passengers and the safe operation of the vehicle.

For your own safety and the safety of your passengers, always note the following points before every trip:

- Make sure that the vehicle's lights and turn signals are working properly.
- Check tyre pressure.
- Ensure that all windows provide a clear and good view of the surroundings.
- Make sure all luggage is secured ⇒ page 17.
- Make sure that no objects can interfere with the pedals.
- Adjust front seat, head restraint and rear vision mirrors properly according to your size.

- Ensure that the passengers in the rear seats always have the head restraints in the in-use position ⇒ page 14.
- Instruct passengers to adjust the head restraints according to their height.
- Protect children with appropriate child seats and properly applied seat belts ⇒ page 46.
- Assume the correct sitting position. Instruct your passengers also to assume a proper sitting position. ⇒ page 10.
- Fasten your seat belt securely. Instruct your passengers also to fasten their seat belts properly. ⇒ page 19.

What affects driving safety?

Driving safety is largely determined by your driving style and the personal behaviour of all vehicle occupants.

As a driver, you are responsible for yourself and your passengers. When your concentration or driving safety is affected by any circumstance, you endanger yourself as well as others on the road ⇒ ⚠, for this reason:

- Always pay attention to traffic and do not get distracted by passengers or telephone calls.
- Never drive when your driving ability is impaired (e.g. by medication, alcohol, drugs).
- Observe traffic laws and speed limits. ▶

- Always reduce your speed as appropriate for road, traffic and weather conditions.
- When travelling long distances, take breaks regularly - at least every two hours.
- If possible, avoid driving when you are tired or stressed.

**WARNING**

When driving safety is impaired during a trip, the risk of injury and accidents increases.

Proper sitting position for occupants

Correct sitting position for driver

The correct sitting position for the driver is important for safe and relaxed driving.

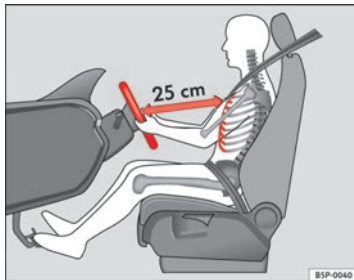



Fig. 1 The correct distance between driver and steering wheel



Fig. 2 Correct head restraint position for driver

For your own safety and to reduce the risk of injury in the event of an accident, we recommend the following adjustments for the driver:

- Adjust the steering wheel so that there is a distance of at least 25 cm between the steering wheel and the centre of your chest ⇒ Fig. 1.
- Move the driver seat forwards or backwards so that you are able to press the accelerator, brake and clutch pedals to the floor with your knees still slightly angled ⇒ .
- Ensure that you can reach the highest point of the steering wheel.
- Adjust the head restraint so that its upper edge is at the same level as the top of your head, or as close as possible to the same level as the top of your head ⇒ Fig. 2.
- Move the seat backrest to an upright position so that your back rests completely against it. ▶

- Fasten your seat belt securely ⇒ page 19.
- Keep both feet in the footwell so that you have the vehicle under control at all times.

Adjustment of the driver seat ⇒ page 135.

 WARNING
<ul style="list-style-type: none"> ● An incorrect sitting position of the driver can lead to severe injuries. ● Adjust the driver seat so that there is at least 25 cm distance between the centre of the chest and the centre of the steering wheel ⇒ Fig. 1. If you are sitting closer than 25 cm, the airbag system cannot protect you properly. ● If your physical constitution prevents you from maintaining the minimum distance of 25 cm, contact a specialised workshop. The workshop will help you decide if special specific modifications are necessary. ● When driving, always hold the steering wheel with both hands on the outside of the ring at the 9 o'clock and 3 o'clock positions. This reduces the risk of injury when the driver airbag is triggered. ● Never hold the steering wheel at the 12 o'clock position, or in any other manner (e.g. in the centre of the steering wheel). In such cases, if the airbag is triggered, you may sustain injuries to the arms, hands and head. ● To reduce the risk of injury to the driver during sudden braking manoeuvres or an accident, never drive with the backrest tilted far back! The airbag system and seat belts can only provide optimal protection when the backrest is in an upright position and the driver is wearing his or her seat belt correctly. The further the seat backrests are tilted to the rear, the greater the risk of injury due to incorrect positioning of the belt web or to the incorrect sitting position! ● Adjust the head restraint properly to achieve optimal protection.

Correct sitting position for front passenger

The front passenger must sit at least 25 cm away from the dash panel so that the airbag can provide the greatest possible protection in the event that it is triggered.

For your own safety and to reduce the risk of injury in the event of an accident, we recommend the following adjustments for the front passenger:

- Move the front passenger seat back as far as possible ⇒ .
- Move the seat backrest to an upright position so that your back rests completely against it.
- Adjust the head restraint so that its upper edge is at the same level as the top of your head, or as close as possible to the same level as the top of your head ⇒ page 13.
- Always keep both feet in the footwell in front of the front passenger seat.
- Fasten your seat belt securely ⇒ page 19.

It is possible to deactivate the front passenger airbag in **exceptional circumstances** ⇒ page 26.

Adjusting the front passenger seat ⇒ page 138. ▶

**WARNING**

- An incorrect sitting position of the front passenger can lead to severe injuries.
- Adjust the front passenger seat so that there is at least 25 cm between your chest and the dash panel. If you are sitting closer than 25 cm, the airbag system cannot protect you properly.
- If your physical constitution prevents you from maintaining the minimum distance of 25 cm, contact a specialised workshop. The workshop will help you decide if special specific modifications are necessary.
- Always keep your feet in the footwell when the vehicle is moving; never rest them on the dash panel, out the window or on the seat. An incorrect sitting position exposes you to an increased risk of injury in case of a sudden braking or an accident. If the airbag is triggered, you could sustain severe injuries due to an incorrect sitting position.
- To reduce the risk of injury to the front passenger in events such as sudden braking manoeuvres or an accident, never travel with the backrest tilted far back! The airbag system and seat belts can only provide optimal protection when the backrest is in an upright position and the front passenger is wearing his or her seat belt properly. The further the seat backrests are tilted to the rear, the greater the risk of injury due to incorrect positioning of the belt web or to the incorrect sitting position!
- Adjust the head restraint correctly in order to achieve maximum protection.

Correct sitting position for passengers in the rear seats

Passengers in the rear seats must sit up straight, keep their feet in the footwells, have the head restraints positioned for use and wear their seat belts properly.

To reduce the risk of injury in the event of a sudden braking manoeuvre or an accident, passengers on the rear seat bench must consider the following:

- Adjust the head restraint to the correct position ⇒ page 14.
- Always keep both feet in the footwell in front of the rear seat.
- Fasten your seat belt securely ⇒ page 19.
- Use an appropriate child restraint system when you take children in the vehicle ⇒ page 46.

**WARNING**

- If the passengers in the rear seats are not sitting properly, they could sustain severe injuries.
- Adjust the head restraint correctly in order to achieve maximum protection.
- Seat belts can only provide optimal protection when seat backrests are in an upright position and the vehicle occupants are wearing their seat belts correctly. If passengers in the rear seats are not sitting in an upright position, the risk of injury due to incorrect positioning of the seat belt increases.

Correct adjustment of front seat head restraints

Properly adjusted head restraints are an important part of passenger protection and can reduce the risk of injuries in most accident situations.

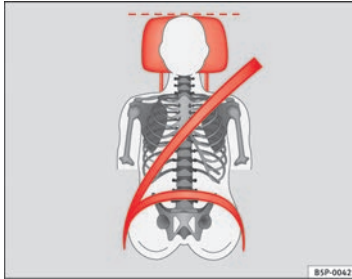

Fig. 3 Correctly adjusted head restraint viewed from the front

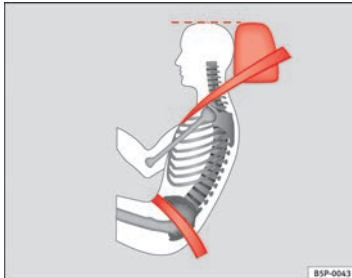

Fig. 4 Correctly adjusted head restraint viewed from the side

Adjust the head restraint correctly in order to achieve maximum protection.

- Adjust the head restraint so that its upper edge is at the same level as the top of your head or as close as possible to the same level as the top of your head and, at the very least, at eye level ⇒ Fig. 3 and ⇒ Fig. 4.

Adjusting the head restraints ⇒ page 135

! WARNING

- Travelling with the head restraints removed or improperly adjusted increases the risk of severe injuries.
- Incorrectly adjusted head restraints could result in death in the event of a collision or accident.
- Incorrectly adjusted head restraints also increase the risk of injury during sudden or unexpected driving or braking manoeuvres.
- The head restraints must always be adjusted according to the height of the passenger.

Active head restraints*

Vehicle occupants are pressed into their seats during a rear end collision. The resulting body pressure on the seat backrest activates the active head restraint* on the front seat, which moves rapidly forwards and upwards at the same time. This movement reduces the distance between the occupant's head and the head restraint, thus reducing the risk of head injuries such as brain trauma.

 **WARNING**

Travelling with the head restraints removed or improperly adjusted increases the risk of severe injuries.

- Incorrectly adjusted head restraints could result in death in the event of a collision or accident.
- Incorrectly adjusted head restraints also increase the risk of injury during sudden or unexpected driving or braking manoeuvres.
- The head restraints must always be adjusted according to the height of the passenger.

 **Note**

The active head restraints* could also be triggered if a vehicle occupant applies a high level of pressure to the seat backrest (e.g. by “falling” back into the seat when entering the vehicle) or if pressure is applied to a front seat head restraint from the rear. This accidental activation is, however, not dangerous, as the active head restraints will return to the original position immediately and are thus once again ready.

Correct adjustment of rear seat head restraints

Properly adjusted head restraints are an important part of the passenger protection and can reduce the risk of injuries in most accident situations

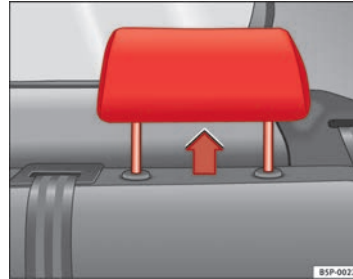

Fig. 5 Head restraints in correct position



Fig. 6 Head restraint position warning label

Rear outer seat head restraints

- The rear outer seat head restraints have 3 positions.
- Two positions for **use** ⇒ Fig. 5. In these positions, the head restraints are used normally, protecting passengers along with the rear seat belts.
- And one position for **non-use**.
- To fit the head restraints in position for use, pull on the edges with both hands in the direction of the arrow.

Centre rear head restraint

- The centre head restraint only has two positions, **in-use** (head restraint up) and **non-use** (head restraint down).



WARNING

- Under no circumstances should the rear passengers travel while the head restraints are in the non-use position. See the warning label located on the rear side fixed window ⇒ Fig. 6.
- Do not swap the centre rear head restraint with either of the outer seat rear head restraints.
- Risk of injury in case of an accident!



CAUTION

Note the instructions on the adjustment of the head restraints ⇒ page 136. ■

Examples of incorrect sitting positions

An incorrect sitting position can lead to severe injuries to vehicle occupants.

Seat belts can provide optimal protection only when the belt webs are properly positioned. Incorrect sitting positions substantially reduce the protective function of seat belts and increase the risk of injury due to incorrect seat belt position. As the driver, you are responsible for all passengers, especially children.

- Never allow anyone to assume an incorrect sitting position in the vehicle while travelling ⇒ ⚠.

The following list contains examples of sitting positions that could be dangerous for all vehicle occupants. The list is not complete, but we would like to make you aware of this issue.

Therefore, whenever the vehicle is in motion:

- Never stand in the vehicle.
- Never stand on the seats.
- Never kneel on the seats.
- Never tilt your seat backrest far to the rear.
- Never lean against the dash panel.
- Never lie on the rear bench.
- Never sit on the front edge of a seat.
- Never sit sideways.
- Never lean out of a window.
- Never put your feet out of a window.
- Never put your feet on the dash panel.
- Never put your feet on the surface of a seat.
- Do not allow anyone to travel in the footwell.



- Never travel without wearing the seat belt.
- Do not allow anyone to travel in the luggage compartment.

**WARNING**

- Any incorrect sitting position increases the risk of severe injuries.
- Sitting in an incorrect position exposes the vehicle occupants to severe injuries if airbags are triggered, by striking a vehicle occupant who has assumed an incorrect sitting position.
- Before the vehicle moves, assume the proper sitting position and maintain it throughout the trip. Before every trip, instruct your passengers to sit properly and to stay in this position during the trip → page 10, Proper sitting position for occupants. ■

Pedal area

Pedals

The operation of all pedals must never be impaired by objects or floor mats.

- Ensure that you can always press the accelerator, brake and clutch pedals unimpaired to the floor.
- Ensure that the pedals can return unimpaired to their initial positions.

Use only floor mats which leave the pedal area free and can be securely fastened on the footwell.

If a brake circuit fails, the brake pedal must be pressed down thoroughly in order to stop the vehicle.

Wearing suitable shoes

Always wear shoes which support your feet properly and give you a good feeling for the pedals.

**WARNING**

- Restricting pedal operation can lead to critical situations while driving.
- Never place objects on the driver footwell. An object could move into the pedal area and impair pedal operation. In the event of a sudden driving or braking manoeuvre, you will not be able to operate the brake, clutch or accelerator pedal. Risk of accident! ■

Floor mats on the driver side

Only floor mats may be used which can be securely fastened in the footwell and do not impair operation of the pedals.

- Ensure that the floor mats are securely fastened during the trip and do not obstruct the pedals → ⚠.

Only use floor mats which leave the pedals clear and which are secured to prevent them from slipping. You can obtain suitable floor mats from a specialised dealership. Fasteners* for floor mats are fitted in the footwells. ►

**WARNING**

- If the pedals are obstructed, an accident may occur. Risk of serious injuries.
- Ensure that the floor mats are always securely attached.
- Never lay or fit floor mats or other floor coverings over the original floor mats. This would reduce the pedal area and could obstruct the pedals. Risk of accident.

Storing objects

Loading the luggage compartment

All luggage and other loose objects must be safely secured in the luggage compartment.

Unsecured objects which shift back and forth could impair the driving safety or driving characteristics of the vehicle by shifting the centre of gravity.

- Distribute the load evenly in the luggage compartment.
- Place heavy objects as far forward as possible in the luggage compartment.
- Place the heavy objects first.
- Secure heavy objects to the fastening rings ⇒ page 18.

**WARNING**

- Loose luggage and other objects in the luggage compartment could cause serious injuries.
- Always stow objects in the luggage compartment and secure them on the fastening rings.
- Use suitable straps to secure heavy objects.
- During sudden manoeuvres or accidents, loose objects can be thrown forward, injuring vehicle occupants or passers-by. This increased risk of injury will be further increased if a loose object is struck by an inflating airbag. If this happens, objects can be transformed into “missiles”. Risk of fatal injury.
- Please note that the centre of gravity may shift when transporting heavy objects; this may affect vehicle handling and lead to an accident. Therefore, it is essential to adjust your speed and driving style accordingly, to avoid accidents.
- Never exceed the allowed axle weights or allowed maximum weight. If the allowed axle load or the allowed total weight is exceeded, the driving characteristics of the vehicle may change, leading to accidents, injuries and damage to the vehicle.
- Never leave your vehicle unattended, especially when the rear lid is open. Children could climb into the luggage compartment, closing the door behind them; they will be trapped and run the risk of death.
- Never allow children to play in or around the vehicle. Close and lock all the doors and rear lid when you leave the vehicle. Before you lock the vehicle, make sure that there are no adults or children in the vehicle.
- Never transport passengers in the luggage compartment. All vehicle occupants must have their seat belt fastened ⇒ page 19.

**Note**

- Air circulation in the vehicle helps reduce fogging of the windows. Used air escapes through ventilation slits in the side trim of the luggage compartment. Ensure that the ventilation slits are never covered.
- Straps for securing the load to the fastening rings are commercially available.

Fastening rings*

There can be four fastening rings in the luggage compartment for fastening luggage and other objects.

- Always use suitable and undamaged straps to secure luggage and other objects to the fastening rings ⇒ ⚠ in Loading the luggage compartment on page 17.
- Pull up the fastening rings to attach the straps.

During a collision or an accident, even small and light objects can build up so much energy that they can cause very severe injuries. The amount of kinetic energy depends on the speed of the vehicle and the weight of the object. The most significant factor, however, is the speed of the vehicle.

Example: An object weighing 4.5 kg is lying unsecured in the vehicle. During a frontal collision at a speed of 50 km/h (30 mph), this object generates a force corresponding to 20 times its weight. That means that the effective weight of the object increases to about 90 kg. You can imagine the severity of the injuries which might be sustained if this object strikes an occupant as it flies through the interior of the vehicle. This increased risk of injury will be further increased if a loose object is struck by an inflating airbag.

**WARNING**

- If pieces of luggage or other objects are secured to the fastening rings with inappropriate or damaged retaining cords, injuries could be sustained in the event of braking manoeuvres or accidents.
- To prevent pieces of luggage or other objects from flying forward, always use appropriate retaining cords which are secured to the fastening rings.
- Never secure a child seat on the fastening rings.

Seat belts

Brief introduction

Before driving: remember your seat belt!

Wearing a seat belt properly can save your life!

In this section you will learn the importance of wearing seat belts, how they work and how to properly fasten, adjust and wear them.

- Read and consider all the information as well as the warnings in this chapter.

WARNING

- If seat belts are worn incorrectly or not at all, the risk of severe injuries increases.
- Properly worn seat belts can reduce severe injuries in case of sudden braking manoeuvres or accidents. For safety reasons, you and all other vehicle occupants must always wear the seat belts properly while the vehicle is moving.
- Pregnant women or people with physical disabilities must also use seat belts. Like all other vehicle occupants, these people can also sustain severe injuries if they are not wearing their seat belts properly.

In some versions, your vehicle is approved **only** for four seats. Two front seats and two rear seats.

WARNING

- Never transport more than the permitted amount of people in your vehicle.
- Every vehicle occupant must properly fasten and wear the seat belt belonging to his or her seat. Children must be protected with an appropriate child restraint system.

Seat belt warning lamp*

The control lamp acts as a reminder to the driver to fasten the seat belt.

Before starting the vehicle:

- Fasten your seat belt securely.
- Instruct your passengers to fasten their seat belts properly before driving off.
- Protect children by using a child seat according to the child's height and weight.

Number of seats

Your vehicle has **five** seats, two in the front and three in the rear. Each seat is equipped with a three-point seat belt.

After the ignition has been switched on, the control lamp  on the instrument panel lights up¹⁾ if the driver has not fastened his/her seat belt, and an audible warning is heard if the vehicle is driven at more than 30 km/h (20 mph).

The warning lamp*  is switched off if the driver seat belt is fastened while the ignition is switched on. ■

¹⁾ Depending on the model version

Why wear seat belts?

Physical principles of frontal collisions

In the event of a frontal collision, a large amount of kinetic energy must be absorbed.

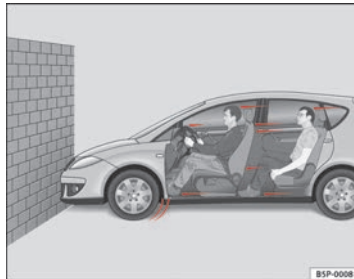

Fig. 7 Vehicle about to hit a wall: the occupants are not wearing seat belts

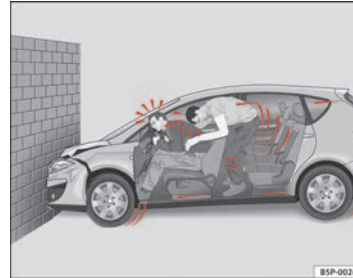

Fig. 8 The vehicle hits the wall: the occupants are not wearing seat belts

It is easy to explain how the laws of physics work in the case of a head-on collision: When a vehicle starts moving \Rightarrow Fig. 7, a certain amount of energy known as kinetic energy is produced in the vehicle and its occupants.

The amount of kinetic energy depends on the speed of the vehicle and the weight of the vehicle and its passengers. The higher the speed and the greater the weight, the more energy there is to be released in an accident.

The most significant factor, however, is the speed of the vehicle. If the speed doubles from 25 km/h (15 mph) to 50 km/h (30 mph), for example, the kinetic energy is multiplied by four.

Because the vehicle occupants in our example are not restrained by seat belts, in the case of a head-on collision all of their kinetic energy has to be absorbed at the point of impact \Rightarrow Fig. 8.

Even at speeds of 30 km/h (20 mph) to 50 km/h (30 mph), the forces acting on bodies in a collision can easily exceed one tonne (1000 kg). At greater speed these forces are even higher. ▶

Vehicle occupants not wearing seat belts are not “attached” to the vehicle. In a head-on collision, they will move forward at the same speed their vehicle was travelling just before the impact. This example applies not only to head-on collisions, but to all accidents and collisions. ■

The danger of not using the seat belt

The general belief that the passengers can protect themselves with their hands in a minor collision is false!



Fig. 9 A driver not wearing a seat belt is thrown forward violently



Fig. 10 The unbelted rear passenger is thrown forward violently, hitting the driver wearing a seat belt

Even at low speeds the forces acting on the body in a collision are so great that it is not possible to brace oneself with one's hands. In a frontal collision, unbelted vehicle occupants are thrown forward and will make violent contact with the steering wheel, dash panel, windscreen or whatever else is in the way → Fig. 9.

The airbag system is not a substitute for seat belts. When triggered, airbags provide only additional protection. All occupants (including the driver) must wear seat belts properly at all times during the trip. This will reduce the risk of severe injuries in the event of an accident – regardless of whether an airbag is fitted for the seat or not.

Note that airbags can be triggered only once. To achieve the best possible protection, the seat belt must always be worn properly so that you will be protected in accidents in which no airbag is deployed.

It is also important for the rear passengers to wear seat belts properly, as they could otherwise be thrown forward violently in an accident. Passengers in the rear seats who do not use seat belts endanger not only themselves but also the front occupants → Fig. 10. ■

Seat belt protection

Passengers not wearing seat belts risk severe injuries in the event of an accident.



Fig. 11 A driver wearing the seat belt properly is secured by the belt in sharp braking

Properly worn seat belts hold the vehicle occupants in the correct sitting positions and substantially reduce the kinetic energy in the event of an accident. Seat belts also help to prevent uncontrolled movements that could lead to severe injuries. In addition, properly worn seat belts reduce the danger of being thrown from the vehicle.

Vehicle occupants wearing their seat belts correctly benefit greatly from the ability of the belts to absorb kinetic energy. The front part of your vehicle and other passive safety features (such as the airbag system) are also designed to absorb the kinetic energy released in a collision. Taken together, all these features reduce the releasing kinetic energy and consequently, the risk of injury.

Our examples describe frontal collisions. Of course, properly worn seat belts substantially reduce the risk of injury in all other types of accidents. This is why it is so important to fasten seat belts before every trip, even when "just driving around the corner".

Ensure that your passengers wear their seat belts as well. Accident statistics have shown that wearing seat belts is an effective means of substantially reducing the risk of injury and improving the chances of survival in a serious accident. Furthermore, properly worn seat belts improve the protection provided by airbags in the event of an accident. For this reason, wearing a seat belt is required by law in most countries.

Although your vehicle is equipped with airbags, the seat belts must be fastened and worn. The front airbags, for example, are only triggered in some frontal accidents. The front airbags will not be triggered during minor frontal collisions, minor side collisions, rear collisions, overturns or accidents in which the airbag trigger threshold value in the control unit is not exceeded.

Therefore, you should always wear your seat belt and ensure that all vehicle occupants have fastened their seat belts properly before you drive off! ■

Safety instructions on using seat belts

If seat belts are used correctly, they can considerably reduce the risk of injury in an accident.

- Always wear the seat belt as described in this section.
- Ensure that the seat belts can be fastened at all times and are not damaged. ▶

**WARNING**

- If the seat belts are worn incorrectly or not at all, the risk of severe injuries increases. The optimal protection from seat belts can be achieved only if you use them properly.
- Fasten your seat belt before every trip - even when driving in town. The other vehicle occupants must also wear the seat belts at all times, otherwise they run the risk of being injured.
- The seat belt cannot offer its full protection if the seat belt is not positioned correctly.
- Never allow two passengers (even children) to share the same seat belt.
- Always keep both feet in the footwell in front of your seat as long as the vehicle is in motion.
- Never unbuckle a seat belt while the vehicle is in motion. Risk of fatal injury.
- The seat belt must never be twisted while it is being worn.
- The seat belt should never lie on hard or fragile objects (such as glasses or pens, etc.) because this can cause injuries.
- Do not allow the seat belt to be damaged or jammed, or to rub on any sharp edges.
- Never wear the seat belt under the arm or in any other incorrect position.
- Loose, bulky clothing (such as an overcoat over a jacket) impairs the proper fit and function of the seat belts, reducing their capacity to protect.
- The slot in the seat belt buckle must not be blocked with paper or other objects, as this can prevent the latch plate from engaging securely.
- Never use seat belt clips, fastening rings or similar instruments to alter the position of the belt webbing.

**WARNING (Continued)**

- Frayed or torn seat belts or damage to the connections, belt retractors or parts of the buckle could cause severe injuries in the event of an accident. Therefore, you must check the condition of all seat belts at regular intervals.
- Seat belts which have been worn in an accident and stretched must be replaced by a specialised workshop. Renewal may be necessary even if there is no apparent damage. The belt anchorage should also be checked.
- Do not attempt to repair a damaged seat belt yourself. The seat belts must not be removed or modified in any way.
- The belts must be kept clean, otherwise the retractors may not work properly ⇒ page 223.

Seat belts

Seat belt adjustment

The seat belts for the front and rear occupants are locked in to position by a latch.



Fig. 12 Belt buckle and latch plate of seat belt

The seat belt cannot offer its full protection if the seat belt is not positioned correctly.

- Adjust the seat and head restraint correctly.
- To fasten the belt, take hold of the latch plate and pull it slowly across your chest and lap.
- Insert the latch plate into the buckle for the appropriate seat and push it down until it is securely locked with an audible click ⇒ Fig. 12.

- Pull the belt to ensure that the latch plate is securely engaged in the buckle.

The seat belts are equipped with an automatic retractor on the shoulder strap. Full freedom of movement is permitted when the shoulder belt is pulled slowly. However, during sudden braking, during travel in steep areas or bends and during acceleration, the automatic retractor on the shoulder belt is locked.

The automatic belt retractors on the front seats are fitted with seat belt tensioners ⇒ page 29.

WARNING

- An incorrectly worn seat belt can cause severe injuries in the event of an accident.
- The seat belts offer best protection only when the backrests are in an upright position and the seat belts have been fastened properly.
- Never put the latch plate in the buckle of another seat. If you do this, the seat belt will not protect you properly and the risk of injury is increased.
- If a vehicle occupant is incorrectly belted in, the seat belt cannot protect him or her properly. An incorrectly positioned seat belt can cause extremely severe injuries.
- Always engage the retractor lock when you are securing a child seat in group 0, 0+ or 1 ⇒ page 46.

Seat belt position

Seat belts offer their maximum protection only when they are properly positioned.

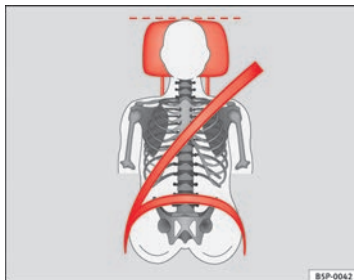

Fig. 13 Correct seat belt and head restraint positions, viewed from front

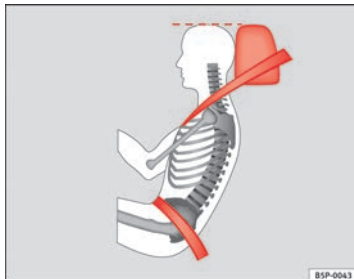

Fig. 14 Correct seat belt and head restraint positions, viewed from side

The following features are available to adjust the seat belt in the shoulder region:

- belt height adjustment for the front seats.
- front seat height adjustment*.



WARNING

- An incorrectly worn seat belt can cause severe injuries in the event of an accident.
- The shoulder part of the seat belt must lie on the centre of the shoulder, never across the neck. The seat belt must lie flat and snugly on the torso ⇒ Fig. 13.
- The lap part of the seat belt must lie across the pelvis, never across the stomach. The seat belt must lie flat and snugly on the pelvis ⇒ Fig. 14. Pull the belt tight if necessary to take up any slack.
- Read and observe the warnings ⇒ page 23.

Pregnant women must also fasten their seat belts properly

The best protection for the unborn child is for the mother to wear the seat belt properly at all times during the pregnancy.



Fig. 15 Positioning seat belts during pregnancy

The seat belt provides maximum protection only when the seat belt is properly positioned ⇒ page 26.

- Adjust the front seat and head restraint correctly ⇒ page 10.
- Holding the latch plate, pull the belt evenly across your chest and as low as possible over the pelvis ⇒ Fig. 15.
- Insert the latch plate into the buckle for the corresponding seat and push it down until it is securely locked with an audible click ⇒ ⚠.
- Pull the belt to ensure that the latch plate is securely engaged in the buckle.

⚠ WARNING

- An incorrectly worn seat belt can cause severe injuries in the event of an accident.
- For pregnant women, the lap part of the seat belt must lie as low as possible over the pelvis, never across the stomach, and always lie flat so that no pressure is exerted on the abdomen.
- Read and observe the warnings ⇒ page 23.

Seat belt release

The seat belt must not be unfastened until the vehicle has come to a standstill.

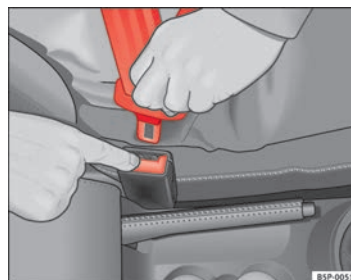

Fig. 16 Remove latch plate from buckle

- Press the red button on the belt buckle ⇒ Fig. 16. The latch plate is released and springs out ⇒ ⚠.

- Guide the belt back by hand so that it rolls up easily and the trim is not damaged.

WARNING

Never unbuckle a seat belt while the vehicle is in motion. If you do, you increase the risk of sustaining severe or fatal injuries.

Adjusting the seat belt height

Seat belt height adjusters can be used to adjust the position of the seat belt at the shoulder.

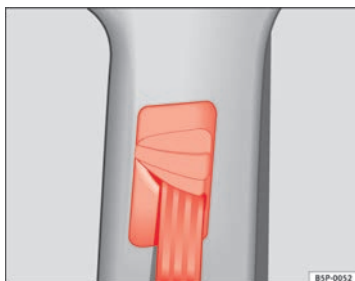

Fig. 17 Location of the belt height adjuster

The seat belt adjuster for the front seats can be used to adjust the proper belt position at the shoulder.

- Press the upper part of the shoulder belt guide and hold it in this position ⇒ Fig. 17.

- Move the shoulder belt guide up or down until you have adjusted the seat belt ⇒ page 26.
- After adjusting, pull the shoulder belt sharply to check that the catch on the shoulder belt guide is engaged securely. ■

Incorrectly fastened seat belts

Incorrectly worn seat belts can cause severe or even mortal injuries.

Seat belts can provide optimal protection only if the belt web is properly worn. The seat belts must be fastened exactly in the order described in this chapter. An incorrect sitting position impairs substantially the protection a seat belt offers and can lead to severe or fatal injuries. The risk of severe or fatal injuries is especially increased when a deploying airbag strikes a vehicle occupant who has assumed an incorrect sitting position. As the driver, you are responsible for yourself and all passengers, especially children. Therefore:

- Never allow anyone to wear the seat belt incorrectly while the vehicle is moving ⇒ .

WARNING

- An incorrectly worn seat belt increases the risk of severe injuries.
- Before every trip, instruct your passengers to adjust their seat belts properly and to wear them for the whole journey.
- Read and always observe information and warnings concerning the use of seat belts ⇒ page 23. ■

Seat belt tensioners

Function of the seat belt tensioner

During a frontal collision, the seat belts on the front seats are retracted automatically.

The seat belts for the occupants in the front seats are equipped with belt tensioners. Sensors will trigger the belt tensioners during severe head-on, lateral and rear collisions only if the seat belt is being worn. This retracts and tightens the seat belts, reducing the forward motion of the occupants.

The seat belt tensioner can be triggered only once.

The seat belt tensioners will not be triggered in the event of a light frontal, side or rear collision, if the vehicle overturns or in situations where no large forces act on the front, side or rear of the vehicle.



Note

- If the seat belt tensioners are triggered, a fine dust is produced. This is normal and it is not an indication of fire in the vehicle.
- The relevant safety requirements must be observed when the vehicle or components of the system are scrapped. Specialised workshops are familiar with these regulations, which are also available to you.

Service and disposal of belt tensioners

The belt tensioners are components of the seat belts that are installed in the seats of your vehicle. If you work on the belt tensioners or remove and install parts of the system when performing other repair work, the seat belt may be damaged. The consequence may be that, in the event of an accident, the belt tensioners function incorrectly or not at all.

So that the effectiveness of the seat belt tensioner is not reduced and that removed parts do not cause any injuries or environmental pollution, regulations, which are known to the specialised workshops, must be observed.



WARNING

- **Improper use or repairs not carried out by qualified mechanics increase the risk of severe or fatal injuries. The belt tensioners may fail to trigger or may trigger in the wrong circumstances.**
- **Never attempt to repair, adjust, remove or install parts of the belt tensioners or seat belts.**
- **The seat belt tensioner, seat belt and automatic retractor cannot be repaired.**
- **Any work on the belt tensioners and seat belts, including the removal and refitting of system parts in conjunction with other repair work, must be performed by a specialised workshop only.**
- **The belt tensioners will only provide protection for one accident and must be changed if they have been activated.**

Airbag system

Brief introduction

Why wear a seat belt and assume the correct sitting position?

For the inflating airbags to achieve the best protection, the seat belt must always be worn properly and the correct sitting position must be assumed.

For your own safety and the safety of the passengers, please ensure the following before driving:

- Always wear the seat belt properly ⇒ page 19.
- Adjust the driver seat and the steering wheel correctly ⇒ page 10.
- Adjust the front passenger seat correctly ⇒ page 11.
- Adjust the head restraint correctly ⇒ page 13.
- Use the correct child restraint system to protect children in your vehicle ⇒ page 46.

The airbag is deployed at high speed in fractions of a second. If you have an incorrect seating position at the time the airbag is deployed, it could cause you critical injuries. Therefore, it is essential that all vehicle occupants assume a correct sitting position while travelling.

Sharp braking before an accident may cause a vehicle occupant not wearing a seat belt to be thrown forward into the area of the deploying airbag. In

this case, the inflating airbag may inflict critical or fatal injuries on the occupant. This also applies to children.

Always maintain the greatest possible distance between yourself and the front airbag. This way, the front airbags can completely deploy when triggered, providing their maximum protection.

The most important factors that will trigger an airbag are: the type of accident, the angle of collision and the speed of the vehicle.

Whether the airbags are triggered depends primarily on the vehicle deceleration rate resulting from the collision and detected by the control unit. If the vehicle deceleration occurring during the collision and measured by the control unit remains below the specified reference values, the front, side and/or curtain airbag will not be triggered. Take into account that the visible damage in a vehicle involved in an accident, no matter how serious, is not a determining factor for the airbags to have been triggered.



WARNING

- **Wearing the seat belt incorrectly or assuming an incorrect sitting position can lead to critical or fatal injuries.**
- **All vehicle occupants, including children, who are not properly belted can sustain critical or fatal injuries if the airbag is triggered. Children up to 12 years old should always travel on the rear seat. Never transport children in the vehicle if they are not restrained or the restraint system is not appropriate for their age, size or weight.**
- **If you are not wearing a seat belt, if you lean forward or to the side while travelling or assume an incorrect sitting position, there is a substantially increased risk of injury. This increased risk of injury will be further increased if you are struck by an inflating airbag.**

 **WARNING (Continued)**

- To reduce the risk of injury from an inflating airbag, always wear the seat belt properly ⇒ page 19.
- Always adjust the front seats properly.

The danger of fitting a child seat on the front passenger seat

Rear-facing child seats must never be used on the front passenger seat when the front passenger airbag is enabled.

The front passenger front airbag is a serious risk for a child if it is activated. The front passenger seat is life threatening to a child if he/she is transported in a rear-facing child seat. Children up to 12 years old should always travel on the rear seat.

If a rear-facing child seat is secured to the front passenger seat, an inflating airbag can strike it with such force that it can cause critical or fatal injuries.

Therefore we strongly recommend you to transport children on the rear seats. That is the safest place for children in the vehicle. Alternatively, the front passenger airbag can be disabled with a key-operated switch ⇒ page 44. When transporting children, use a child seat suitable for the age and size of each child ⇒ page 46.

For those vehicles that do not include a key lock switch to deactivate the airbag, the vehicle must be taken to a Technical Service.

 **WARNING**

- If a child seat is secured to the front passenger seat, the risk to the child of sustaining critical or fatal injuries in the event of an accident increases.
- Never secure a rear-facing child seat to the front passenger seat if the front passenger airbag is enabled. The child can suffer critical or fatal injuries if the front passenger airbag is triggered.
- An inflating front passenger airbag can strike the rear-facing child seat and project it with great force against the door, the roof or the backrest.
- If, under special circumstances, it is necessary to transport a child in a rear-facing child seat on the front passenger seat, it is absolutely essential that you observe the following safety measures:
 - Deactivate the front passenger airbag ⇒ page 44, Deactivating airbags*.
 - Child seats must be approved by the child seat manufacturer for use on a front passenger seat with front or side airbag.
 - Follow the installation instructions given by the child seat manufacturer and observe the safety instructions ⇒ page 46, Child safety.
 - Before properly installing the child seat, push the front passenger seat completely backwards so that the greatest possible distance to the front passenger airbag is ensured.
 - Ensure that no objects prevent the front passenger seat from being pushed completely back.
 - The backrest of the front passenger seat must be in an upright position.

Control lamp for airbag and seat belt tensioner

This control lamp monitors the airbag and seat belt tensioner system.

The control lamp monitors all airbags and seat belt tensioners in the vehicle, including control units and wiring connections.

Monitoring of airbag and belt tensioner system

Both the airbag and belt tensioner systems operation is constantly monitored electronically. Each time the ignition is switched on, the control lamp  lights for several seconds and the instrument panel display* shows **AIRBAG/TENSIONER**.

The system must be checked when the control lamp :

- does not light up when the ignition is switched on
- turns off after 4 seconds after the ignition is switched on
- turns off and then lights up again after the ignition is switched on
- lights up or flashes while the vehicle is moving

In the event of a malfunction, the warning lamp remains on continuously. In addition, depending on the malfunction, a fault message appears in the instrument panel display for approx. 10 seconds and a short audible warning is given. In this event, you should have a specialised workshop check the system immediately.

If any of the airbags are disabled by a Technical Service, the warning lamp lights for several seconds more after the verification and will turn off if there is no fault.



WARNING

- If there is a malfunction, the airbag and belt tensioner system cannot properly perform its protective function.
- If a malfunction occurred, have the system checked immediately by a specialised workshop. Otherwise, in the event of an accident, the airbag system and belt tensioners may not be triggered, or may not be triggered correctly.

Repairs, maintenance and disposal of airbags

The parts of the airbag system are installed in various places in your vehicle. If work is carried out on the airbag system or parts have to be removed and fitted on the system when performing other repair work, parts of the airbag system may be damaged. In the event of an accident this could cause the airbag to inflate incorrectly or not inflate at all.

The relevant safety requirements must be observed when the vehicle or components of the airbag are **scrapped**. Specialised workshops and vehicle disposal centres are familiar with these requirements.



WARNING

- If repairs are not carried out by a professional, or if the airbags are used incorrectly, the risk of severe or fatal injuries is increased. The airbags may fail to inflate, or could inflate in the wrong circumstances.
- Do not cover or stick anything on the steering wheel hub or the surface of the airbag unit on the passenger side of the dash panel, and do not obstruct or modify them in any way.
- It is important not to attach any objects such as cup holders or telephone mountings to the surfaces covering the airbag units.

 **WARNING (Continued)**

- To clean the steering wheel or dash panel, you may use only a dry or a water-moistened cloth. Never clean the dash panel and the airbag module surface with cleaners containing solvents. Solvents cause the surface to become porous. If the airbag triggered, plastic parts could become detached and cause injuries.
- Never attempt to repair, adjust, remove or install parts of the airbag system.
- Any work on the airbag system or removal and installation of the airbag components for other repairs (such as repairs to the steering wheel) should be performed only by a specialised workshop. Specialised workshops have the necessary tools, repair information and qualified personnel.
- We strongly recommend you to go to a specialised workshop for all work on the airbag system.
- Never attempt to alter the front bumper or the body.
- The airbags provide protection for just one accident; replace them once they have deployed.

**For the sake of the environment**

The airbags, which are a special type of waste, must be disposed of through an authorised service, because they contain pyrotechnic elements. ■

Front airbags

Description of front airbags

The airbag system is not a substitute for the seat belts.



Fig. 18 Driver airbag located in steering wheel

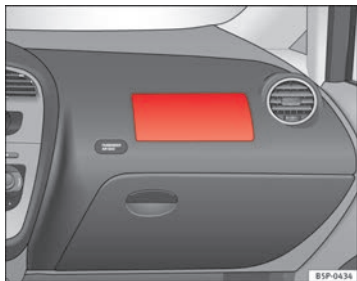

Fig. 19 Front passenger airbag located in dash panel

The front airbag for the driver is located in the steering wheel ⇒ Fig. 18 and the airbag for the front passenger is located in the dash panel ⇒ Fig. 19. Airbags are identified by the word "AIRBAG".

In conjunction with the seat belts, the front airbag system gives the front occupants additional protection for the head and chest in the event of a severe frontal collision ⇒ page 37, Safety notes on the front airbag system.

In addition to their normal function of restraining the occupants, the seat belts also hold the driver and front passenger in a position where the airbags can provide maximum protection in a frontal collision.

The airbag system is not a substitute for seat belts, but it is an integral part of the vehicle's overall passive safety system. Please bear in mind that the airbag system can only work effectively when the vehicle occupants are wearing their seat belts correctly and have adjusted the head restraints properly. Therefore, it is most important to wear the seat belts at all times, not only because this is required by law in most countries, but also for your safety ⇒ page 19, Brief introduction.

The main parts of the front airbag system are:

- an electronic control and monitoring system (control unit)
- the two front airbags (airbag with gas generator) for the driver and front passenger
- a control lamp  on the dash panel ⇒ page 32

The airbag system operation is monitored electronically. The airbag control lamp will light up for a few seconds every time the ignition is switched on (self-diagnosis).

There is a fault in the system if the control lamp :

- does not light up when the ignition is switched on ⇒ page 32
- turns off after 4 seconds after the ignition is switched on
- turns off and then lights up again after the ignition is switched on
- lights up or flashes while the vehicle is moving

The front airbag system will not be triggered if:

- the ignition is switched off
- there is a minor frontal collision
- there is a side collision
- there is a rear-end collision
- the vehicle turns over

 **WARNING**

- The seat belts and airbags can only provide maximum protection if the occupants are seated correctly ⇒ page 10, Proper sitting position for occupants.
- If a fault has occurred in the airbag system, have the system checked immediately by a specialised workshop. Otherwise, during a frontal collision the system may fail to trigger, or not trigger correctly.

Operation of front airbags

Inflated airbags reduce the risk of injuries to the head or chest.



Fig. 20 Inflated front airbags

The airbag system is designed so that the airbags for the driver and front passenger are triggered in a severe frontal collision.

In certain types of accident the front, curtain and side airbags may be triggered together.

When the system is triggered, the airbags fill with a propellant gas and deploy in front of the driver and front passenger ⇒ Fig. 20. The fully deployed airbags cushion the forward movement of the front occupants and help to reduce the risk of injury to the head and the upper part of the body.

The special design of the airbag allows the controlled escape of the propellant gas when an occupant puts pressure on the bag. Thus, the head and chest are surrounded and protected by the airbag. After the collision, the airbag deflates sufficiently to allow visibility. ▶

The airbags deploy extremely rapidly, within thousandths of a second, to provide additional protection in the event of an accident. A fine dust may

develop when the airbag deploys. This is normal and it is not an indication of fire in the vehicle. ■

Airbag covers when the frontal airbags are triggered

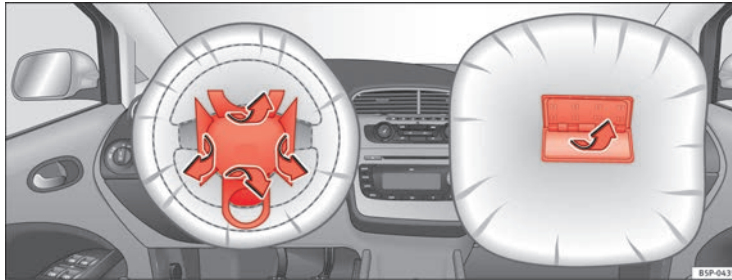

Fig. 21 Airbag covers reacting when the front airbags are triggered

The airbag covers fold out of the steering wheel or dash panel when the driver and front passenger airbags are triggered → Fig. 21. The airbag covers remain connected to the steering wheel or the dash panel. ■

Safety notes on the front airbag system

If you use airbags correctly, they can considerably reduce the risk of injury in many kinds of accident.

WARNING

- It is important for the driver and front passenger to keep a distance of at least 25 cm from the steering wheel and dash panel. If the minimum distance is not observed then the airbags do not correctly protect the vehicle occupants; risk of fatal injuries! In addition, the front seats and head restraints must always be positioned correctly for the height of the occupant.
- If you are not wearing a seat belt, if you lean forward or to the side while travelling or assume an incorrect sitting position, there is a substantially increased risk of injury. This increased risk of injury will be further increased if you are struck by an inflating airbag.
- Never let a child travel on the front seat without an appropriate restraint system. If the airbag is triggered in an accident, children can sustain serious or fatal injuries from the airbag as it inflates ⇒ page 46, Child safety.
- The deployment space between the front passengers and the airbags must not in any case be occupied by other passenger, pets and objects.
- The airbags provide protection for just one accident; replace them once they have deployed.
- It is also important not to attach any objects such as cup holders or telephone mountings to the surfaces covering the airbag units.
- Do not attempt to modify components of the airbag system in any way.

Side airbags*

Description of side airbags

The airbag system is not a substitute for the seat belts.



Fig. 22 Side airbag in driver seat

The front side airbags are located in the driver seat and front passenger seat backrests ⇒ Fig. 22. The rear side airbags are located in the rear wheel housing lining. The locations are identified by the text “AIRBAG” in the upper region of the backrests and in the rear wheel housing lining.

Together with the seat belts, the side airbag system gives the front seat occupants additional protection for the upper body in the event of a severe side collision ⇒ page 40, Safety notes on the operation of the side airbag system.

In a side collision, the side airbags reduce the risk of injury to passengers on the front seats to the areas of the body facing the impact. In addition to their normal function of protecting the occupants in a collision, the seat belts also hold the passengers in the front seats and the outer rear seats in a position where the side airbags can provide maximum protection.

The airbag system is not a substitute for seat belts, but it is an integral part of the vehicle's overall passive safety system. Please bear in mind that the airbag system can only work effectively when the occupants are wearing their seat belts. Therefore, it is most important to wear the seat belts at all times, not only because this is required by law in most countries, but also for your safety ⇒ page 19, Brief introduction.

The side airbag system will not be triggered if:

- the ignition is switched off
- there is a minor side collision
- there is a frontal collision
- there is a rear-end collision
- the vehicle turns over

The main parts of the airbag system are:

- an electronic control and monitoring system (control unit)
- The front side airbags in the backrests of the front seats and the rear side airbags in the lining of the rear wheel housing
- a control lamp  on the dash panel ⇒ page 32

The airbag system operation is monitored electronically. The airbag control lamp will light up for approx. 4 seconds every time the ignition is switched on (self-diagnosis).



WARNING

- **In a side collision, the side airbags will not work, if the sensors do not correctly measure the pressure increase on the interior of the doors, due to air escaping through the areas with holes or openings in the door panel.**
- **Never drive the vehicle if the interior panels have been removed.**
- **Never drive if the interior door panels have been removed or if the panels have not been correctly fitted.**

 **WARNING (Continued)**

- Never drive the vehicle if the loudspeakers in the door panels have been removed, unless the holes left by the loudspeakers have been correctly closed.
- Always check that the openings are closed or covered if loudspeakers or other equipment are fitted in the interior door panels.
- Any work carried out to the doors should be made in an authorised specialised workshop.
- The seat belts and airbags can only provide maximum protection if the occupants are seated correctly ⇒ page 10, Proper sitting position for occupants.
- If a fault has occurred in the airbag system, have the system checked immediately by a specialised workshop. Otherwise, during a side collision, the system may fail to trigger, or not trigger correctly.

Operation of side airbags

Inflated airbags can reduce the risk of head or chest injury in many side impact collisions.

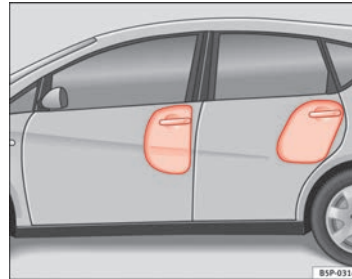

Fig. 23 Inflated side airbag on left side of vehicle

In some **side collisions**, the side airbag is triggered on the impact side of the vehicle ⇒ Fig. 23.

In certain types of accident the front, curtain and side airbags may be triggered together.

When the system is triggered, the airbag is filled with propellant gas.

The airbags deploy extremely rapidly, within thousandths of a second, to provide additional protection in the event of an accident. A fine dust may develop when the airbag deploys. This is normal and it is not an indication of fire in the vehicle.

The fully deployed airbags cushion the movement of the occupants of the front seats and the outer rear seats and help to reduce the risk of injury to the upper body.

The special design of the airbag allows the controlled escape of the propellant gas when an occupant puts pressure on the bag. Thus, the head and chest are surrounded and protected by the airbag.

Safety notes on the operation of the side airbag system

If airbags are used correctly, they can considerably reduce the risk of injury in side impact collisions.

WARNING

- If you do not wear a seat belt, if you lean forward, or are not seated correctly while the vehicle is in motion, you are at a greater risk of injury if the side airbag system is triggered in an accident.
- In order for the side airbags to provide their maximum protection, the prescribed sitting position must always be maintained with seat belts fastened while travelling.
- Occupants of the outer seats must never carry any objects or pets in the deployment space between them and the airbags, or allow children or other passengers to travel in this position. It is also important not to attach any accessories (such as cup holders) to the doors. This would impair the protection offered by the side airbags.
- The built-in coat hooks should be used only for lightweight clothing. Do not leave any heavy or sharp-edged objects in the pockets.
- Great forces, such as hard blows or kicks, must not be exerted upon the backrest bolster because the system may be damaged. In this case, the side airbags would not be triggered.

WARNING (Continued)

- Under no circumstances should protective covers be fitted over seats with side airbags unless the covers have been approved for use in your vehicle. Because the airbag is triggered from the side of the backrest, the use of non-approved seat covers would obstruct the side airbag, seriously reducing the airbag's effectiveness ⇒ page 224, Accessories, replacement of parts and modifications.
- Any damage to the original seat upholstery or around the seams of the side airbag units must be repaired immediately by a specialised workshop.
- The airbags provide protection for just one accident; replace them once they have deployed.
- When children assume an incorrect sitting position, they expose themselves to an increased risk of injury in the event of an accident. This is particularly the case if the child is travelling on the front passenger seat and the airbag system is triggered in an accident; this could have critical consequences including serious injury or death ⇒ page 46, Child safety.
- Any work on the side airbag system or removal and installation of the airbag components for other repairs (such as removal of the front seat) should only be performed by a specialised workshop. Otherwise, faults may occur during the airbag system operation.
- Do not attempt to modify components of the airbag system in any way.
- The side and head airbags are managed through sensors located in the interior of the front doors. To ensure the correct operation of the side and head airbags neither the doors nor the door panels should be modified in any way (e.g. fitting loudspeakers). If the front door is damaged, the airbag system may not work correctly. All work carried out on the front door must be done in a specialised workshop.

Curtain airbags

Description of curtain airbags

The airbag system is not a substitute for the seat belts.



Fig. 24 Location of head airbags on the left side of the vehicle

The curtain airbags are located on both sides in the interior above the doors ⇒ Fig. 24 and are identified with the text "AIRBAG".

In conjunction with the seat belts, the curtain airbag system gives the vehicle occupants additional protection for the head and upper body in the event of a severe side collision ⇒ page 42, Safety notes on the operation of the curtain airbag system.

The airbag system is not a substitute for seat belts, but it is an integral part of the vehicle's overall passive safety system. Please bear in mind that the airbag system can only work effectively when the vehicle occupants are wearing their seat belts correctly and have adjusted the head restraints properly. Therefore, it is most important to wear the seat belts at all times, not only because this is required by law in most countries, but also for your safety ⇒ page 19, Brief introduction.

The main parts of the curtain airbag system are:

- an electronic control and monitoring system (control unit)
- the curtain airbags (airbags with gas generator) for the driver, front passenger and passengers on the rear seats
- a control lamp  on the dash panel ⇒ page 32

The airbag system operation is monitored electronically.

The curtain airbag system will not be triggered if:

- the ignition is switched off
- there is a frontal collision
- there is a rear-end collision

- the vehicle turns over
- there is a minor side collision

**WARNING**

If a fault has occurred in the airbag system, have the system checked immediately by a specialised workshop. Otherwise there is a danger that during a collision, the system may fail to trigger, or not trigger correctly.

Operation of curtain airbags

Fully inflated airbags reduce the risk of head or chest injury in a side collision.

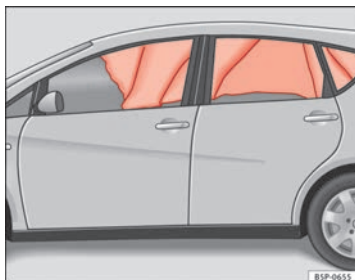

Fig. 25 Deployed curtain airbags

During some **side collisions** the curtain airbag is triggered on the impact side of the vehicle ⇒ Fig. 25.

In certain types of accident the front, side and curtain airbags may be triggered together.

When the system is triggered, the airbag is filled with propellant gas. In the process, the curtain airbag covers the side windows and door pillars.

The airbags deploy extremely rapidly, within thousandths of a second, to provide additional protection in the event of an accident. A fine dust may develop when the airbag deploys. This is normal and it is not an indication of fire in the vehicle.

The fully deployed airbags cushion the movement of the front occupants and help to reduce the risk of injury to the upper body.

The special design of the airbag allows the controlled escape of the propellant gas when an occupant puts pressure on the bag. Thus, the head and chest are surrounded and protected by the airbag.

Safety notes on the operation of the curtain airbag system

If you use airbags correctly, they can considerably reduce the risk of injury in many kinds of accident.

**WARNING**

- In order for the side airbags to provide their maximum protection, the prescribed sitting position must always be maintained with seat belts fastened while travelling.
- For safety reasons, the curtain airbag must be disabled in those vehicles fitted with a screen dividing the interior of the vehicle. See a Technical Service to make this adjustment.
- There must be no other persons, animals or objects between the occupants of the outer seats and the deployment space of the curtain airbags so that the curtain airbag can deploy without restriction and provide the greatest possible protection. Therefore, sun blinds which have

 **WARNING (Continued)**

not been expressly approved for use in your vehicle may not be attached to the side windows ⇒ page 224, Accessories, replacement of parts and modifications.

- The built-in coat hooks should be used only for lightweight clothing. Do not leave any heavy or sharp-edged objects in the pockets. Please, do not hang the clothes on coat hangers.
- The airbags provide protection for just one accident; replace them once they have deployed.
- Any work on the curtain airbag system or removal and installation of the airbag components for other repairs (such as removal of the roof lining) should only be performed by a specialised workshop. Otherwise, faults may occur during the airbag system operation.
- Do not attempt to modify components of the airbag system in any way.
- The side and head airbags are managed through sensors located in the interior of the front doors. To ensure the correct operation of the side and head airbags neither the doors nor the door panels should be modified in any way (e.g. fitting loudspeakers). If the front door is damaged, the airbag system may not work correctly. All work carried out on the front door must be done in a specialised workshop.

Deactivating airbags*

Front passenger front airbag deactivation

If you fit a rear-facing child seat to the front passenger seat, the front passenger front airbag must be de-activated.



Fig. 26 In the glove compartment: switch for activating and deactivating the front passenger airbag



Fig. 27 Control lamp for deactivated front passenger airbag in centre console

When the front passenger airbag is **deactivated**, only the front airbag is deactivated. All the other airbags in the vehicle remain activated.

Deactivating the front passenger front airbag

- Switch the ignition off.
- Turn the ignition switch in the key operated switch in the glove compartment to the position **OFF** ⇒ Fig. 26.
- Check that the control lamp, “OFF”, on the instrument panel ⇒ Fig. 27 remains lit when the ignition is switched on ⇒ ⚠.

Activating the front passenger front airbag

- Switch the ignition off.
- Turn the ignition key in the key-operated switch in the glove compartment to the position **ON** ⇒ Fig. 26. ▶

- Check that the control lamp on the instrument panel ⇒ Fig. 27 does not light up when the ignition is switched on ⇒ ⚠.

 **WARNING**

- The driver is responsible for the proper position of the key-operated switch.
- You should only deactivate the front passenger front airbag when, in exceptional cases, you have to use a rear-facing child seat on the front passenger seat ⇒ page 46, Child safety.
- Never install a child seat facing backwards on the front passenger seat unless the front passenger front airbag has been disabled. Otherwise, there is a risk of death. If under exceptional circumstances it is necessary to transport a child in a rear-facing child seat on the front passenger seat, you must always disable the front passenger front airbag.
- As soon as the child seat is no longer needed on the front passenger seat, enable the front passenger front airbag again.
- Only deactivate the front passenger front airbag when the ignition is off, otherwise a fault may occur in the airbag system, which could cause the airbag to not deploy properly or not deploy at all.

 **WARNING (Continued)**

- When the front passenger front airbag is deactivated, if the control lamp AIRBAG OFF is not continuously lit up, there may be a fault in the airbag system:
 - Have the airbag system inspected immediately by a specialised workshop.
 - Do not use a child seat on the front passenger seat! The front passenger front airbag could be triggered despite the fact that there is a fault in the system and, as a result, a child could sustain serious or fatal injuries.
 - It is unpredictable whether the front passenger airbag will deploy in the event of an accident. Warn all your passengers of this.
- When using the ignition key to activate/deactivate the front passenger front airbag, only the front passenger airbag will be activated/deactivated. The side airbag and head airbag on the passenger side will remain active.

Child safety

Brief introduction

Introduction

Statistics show that children are generally safer on the rear seat than on the front passenger seat.

For safety reasons we recommend that children under 12 years of age travel on the rear seats. Depending on their age, height and weight, children travelling on the rear seat must use a child seat or a seat belt. For safety reasons, the child seat should be installed in the centre of the rear seat or behind the front passenger seat.

The physical laws involved and the forces acting in a collision apply also to children → page 21, Why wear seat belts?. But unlike adults, children do not have fully developed muscle and bone structures. This means that children are subject to a greater risk of injury.

To reduce this risk, children must always use special child restraint systems when travelling in the vehicle.

We recommend the use of child safety products from the SEAT Original Accessories Programme, which includes systems for all ages made by Peke¹⁾.

These systems have been especially designed and approved, complying with the ECE-R44. regulation.

Follow the manufacturer's instructions and observe any statutory requirements when installing and using child seats. Always read and note → page 46, Safety notes on using child seats.

We recommend you to always include the manufacturer's Child Seat Instruction Manual together with the on-board documentation. ■

Safety notes on using child seats

Proper use of child seats substantially reduces the risk of injury in an accident!

As the driver, you are responsible for any children you transport in your vehicle.

- Protect your children by properly using the appropriate child seats ⇒ page 48.
- Always ensure that the seat belt is properly positioned according to the instructions provided by the manufacturer of the child seat.
- When travelling, do not allow children to distract you from traffic.
- Take breaks regularly during long trips. Take a break at least every two hours. ▶

¹⁾ Not for all countries

**WARNING**

- Never install a child seat facing backwards on the front passenger seat unless the front passenger front airbag has been disabled. Risk of potentially fatal injuries to the child! However, if it is necessary, in exceptional cases, to transport a child in the front passenger seat, the front passenger front airbag must always be disabled ⇒ page 44, Deactivating airbags*. If the passenger seat has a height adjustment option, move it to the highest position.
- For those vehicles that do not include a key lock switch to deactivate the airbag, the vehicle must be taken to a Technical Service.
- All vehicle occupants, especially children, must assume the proper sitting position and be properly belted in while travelling.
- Never hold children or babies on your lap, this can result in potentially fatal injuries to the child!
- Never allow a child to be transported in a vehicle without being properly secured, or to stand up or kneel on a seat while travelling. In an accident, the child could be flung through the vehicle, causing possibly fatal injuries to themselves and to the other vehicle occupants.
- If children assume an improper sitting position when the vehicle is moving, they expose themselves to greater risk of injury in the event of a sudden braking manoeuvre or in an accident. This is particularly important if the child is travelling on the front passenger seat and the airbag system is triggered in an accident; as this could cause serious injury or even death.
- A suitable child seat can protect your child!
- Never leave an unsupervised child alone on a child seat or in the vehicle.
- Depending on weather conditions, it may become extremely hot or cold inside the vehicle. This can be fatal.

**WARNING (Continued)**

- Children who are less than 1.5 metres tall must not wear a normal seat belt without a child seat, as this could cause injuries to the abdominal and neck areas during a sudden braking manoeuvre or in an accident.
- Do not allow the seat belt to become twisted or jammed, or to rub on any sharp edges.
- Incorrectly worn seat belts can cause injuries even in a minor collision or in sudden braking manoeuvres.
- The seat belt provides maximum protection only when the seat belt is properly positioned ⇒ page 25, Seat belts.
- Only one child may occupy a child seat ⇒ page 48, Child seats.

Child seats

Categorisation of child seats into groups

Use only child seats that are officially approved and suitable for the child.

Child seats are subject to the regulation ECE-R 44. ECE-R stands for: Economic Commission for Europe Regulation

The child seats are grouped into 5 categories:

Group 0: up to 10 kg

Group 0+: up to 13 kg

Group 1: from 9 to 18 kg

Group 2: from 15 to 25 kg

Group 3: from 22 to 36 kg

Child seats that have been tested and approved under the ECE R44 standard bear the test mark on the seat (the letter E in a circle with the test number below it).

Group 0 and 0+ child seats

A suitable child seat and a correctly adjusted seat belt can help you to protect your child.

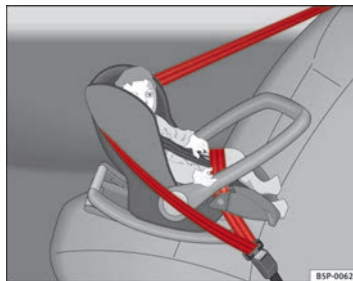

Fig. 28 A group 0 rear-facing child seat fitted on the rear seat

Group 0: For babies up to about 9 months old and 10 kg in weight, the most suitable seats are those appearing in the illustration ⇒ Fig. 28.

Group 0+: For babies up to about 18 months old and 13 kg in weight the most suitable seats are those appearing in the illustration.

Follow the manufacturer's instructions and observe any statutory requirements when installing and using child seats.

We recommend you to always include the manufacturer's Child Seat Instruction Manual together with the on-board documentation.



WARNING

Read and always observe information and warnings concerning the use of child seats ⇒ ⚠ in Safety notes on using child seats on page 47.

Group 1 child seats

A suitable child seat and a correctly adjusted seat belt can help you to protect your child.



Fig. 29 A category 1 forward-facing child seat fitted on the rear seat.

Child seats using the ISOFIX system or seats in which the child faces the rear of the vehicle are most appropriate for babies and small children weighing between 9 and 18 kg.

Follow the manufacturer's instructions and observe any statutory requirements when installing and using child seats.

We recommend you to always include the manufacturer's Child Seat Instruction Manual together with the on-board documentation.

WARNING

Read and always observe information and warnings concerning the use of child seats ⇒  in Safety notes on using child seats on page 47. ■

Group 2 and 3 child seats

A suitable child seat and a correctly adjusted seat belt can help you to protect your child.



Fig. 30 Forward-facing child seat installed on rear seat

Follow the manufacturer's instructions and observe any statutory requirements when installing and using child seats.

We recommend you to always include the manufacturer's Child Seat Instruction Manual together with the on-board documentation.

Group 2 child seats

Children *under* 7 years of age weighing between 15 and 25 kg are best protected by group 2 child seats together with properly adjusted seat belts.

Group 3 child seats

Children *over* 7 years of age weighing between 22 and 36 kg but less than 1.5 metres tall are best protected by child seats with head restraints together with properly worn seat belts ⇒ **Fig. 30.** ▶

**WARNING**

- The shoulder part of the seat belt must lie approximately on the centre of the shoulder, never across the neck or the arm. The seat belt must lie close to the upper part of the body. The lap belt part must lie across the pelvis, not across the stomach, and always fit closely. Pull the belt tight if necessary to take up any slack ⇒ page 25, Seat belts.
- Read and always observe information and warnings concerning the use of child seats ⇒  in Safety notes on using child seats on page 47. ■

Securing child seats

Ways to secure a child seat

A child seat can be secured differently on the rear seat and on the front passenger seat.

You can secure a child seat to the rear seat or front passenger seat in the following ways:

- Child seats in groups **0 to 3** can be secured with a seat belt.
- Child seats in groups **0, 0+ and 1** with the ISOFIX and Top Tether* systems can be secured without using the seatbelt, thanks to the ISOFIX and Top Tether* ⇒ page 52 securing rings.

Mass group	Seating position		
	Front passenger seat	Rear side seat	Rear central seat
Group 0 to 10 kg	U*	U	U
Group 0+ to 13 kg	U*	U	U
Group I 9 to 18 kg	U*	U	U
Group II 15 to 25 kg	U*	U	U
Group III 22 to 36 kg	U*	U	U

U: Suitable for universal restraint systems for use in this mass group.

*: Move the front passenger seat as far back as possible, as high as possible and always disable the airbag.



WARNING

- When travelling, children must be secured in the vehicle with a restraint system suitable for age, weight and size.
- Never install a child seat facing backwards on the front passenger seat unless the front passenger airbag has been disabled. This could cause fatal injuries to the child! However, if, in exceptional cases, it is necessary to transport a child in the front passenger seat, the front passenger airbag ⇒ page 44, Deactivating airbags* must always be disabled and the seat adjusted to its highest position, where possible.
- Read and always observe information and warnings concerning the use of child seats ⇒ ⚠ in Safety notes on using child seats on page 47.

Child seats fastened with the “ISOFIX” and Top Tether* system

Child seats with the ISOFIX or Top Tether* system can be secured quickly, easily and safely on the rear outer seats.

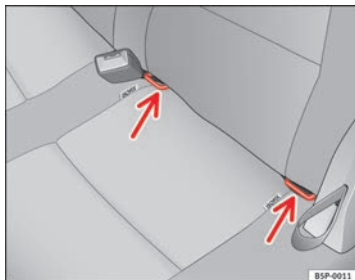

Fig. 31 ISOFIX securing rings



Fig. 32 Top Tether* securing ring

When removing or fitting the child seat, please be sure to follow the manufacturer's instructions.

- Move the rear seat as far to the rear as it will go.
- Press the child seat onto the ISOFIX retaining rings until the child seat can be heard to engage securely. If the child seat is equipped with Top Tether* anchor points, secure it to the correspondent ring ⇒ Fig. 32. Observe the manufacturer's instructions.
- Pull on both sides of the child seat to ensure that it is secure.

Two ISOFIX retaining rings are fitted on each rear seat. In some vehicles, the rings are secured to the seat frame and, in others, they are secured to the rear floor. The access to the ISOFIX rings is between the rear seat backrest and the seat cushioning. The Top Tether* anchors are located at the rear of the backrests of the rear seats (behind the seat backrest or in the luggage compartment).

Child seats with the ISOFIX and Top Tether* attachment system are available from Technical Services. ▶

Mass group	Size class	Electrical equipment	Mounting direction	Vehicle Isofix positions
				Rear side seats
Baby carrier	F	ISO/L1	Backward-facing	X
	G	ISO/L2	Backward-facing	X
Group 0 to 10 kg	E	ISO/R1	Backward-facing	IU
	E	ISO/R1	Backward-facing	IU
Group 0+ to 13 kg	D	ISO/R2	Backward-facing	IU
	C	ISO/R3	Backward-facing	IU
	D	ISO/R2	Backward-facing	IU
Group I 9 to 18 kg	C	ISO/R3	Backward-facing	IU
	B	ISO/F2	Forward-facing	IU
	B1	ISO/F2X	Forward-facing	IU
	A	ISO/F3	Forward-facing	IU
	---	---	---	---
Group II 15 to 25 kg	---	---	Forward-facing	---
Group III 22 to 36 kg	---	---	Forward-facing	---

IU: Suitable for ISOFIX universal child restraint systems approved for use in this mass group

X: ISOFIX position not suitable for ISOFIX child restraint systems for this mass group or size class

WARNING

- The securing rings are designed only for use with ISOFIX and Top Tether* child seats.
- Never secure child seats that do not have the ISOFIX and Top Tether* system, retaining belts or secure other objects to the securing rings – this could result in potentially fatal injuries to the child!
- Ensure that the child seat is secured correctly using the “ISOFIX” and Top Tether* securing rings.

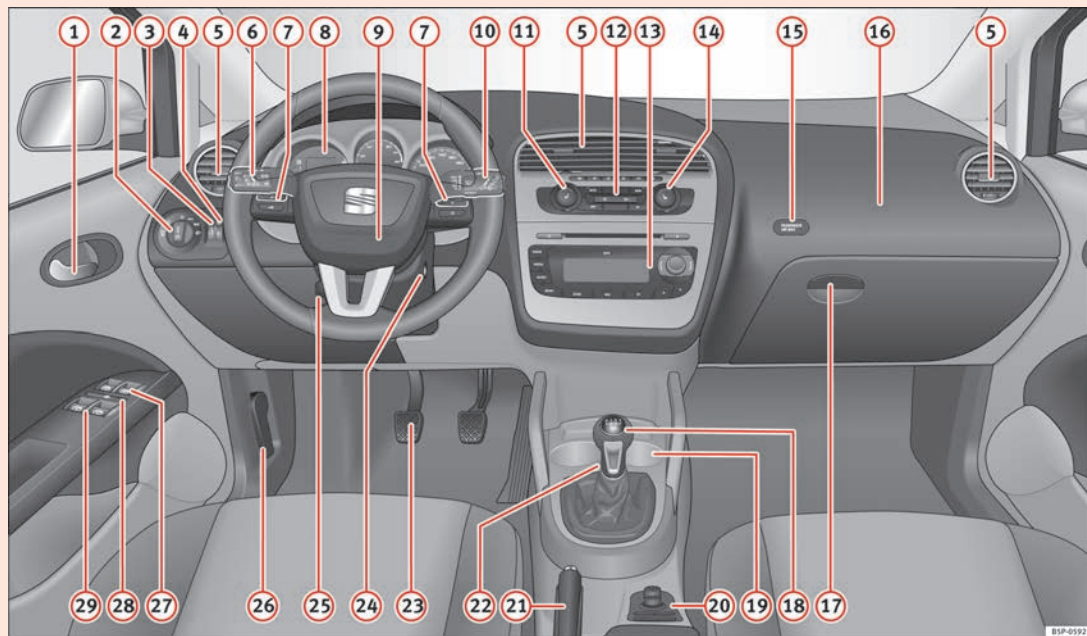

Fig. 33 Dash panel

81P-0192

Operating Instructions

Cockpit

Overview

Overview of the dash panel

This overview will help you to familiarise yourself with the controls and displays.

① Door release lever	
② Light switch	116
③ Light intensity regulator for the instruments and controls	120
④ Headlight range control	120
⑤ Air vents	
⑥ Turn signal and main beam lever and cruise control system*	123, 190
⑦ Controls on the steering wheel	91
⑧ Instrument panel:	
– Instruments	57
– Display	61
– Control and warning lamps	77
⑨ Horn (works only when the ignition is on) / Driver front airbag	30
⑩ Windscreen wiper and washer lever and operation of the multifunction display*	128, 63
⑪ Left seat heating button	139
⑫ Controls for	
– Heating* and ventilation	157
– Climatic*	159
– Climatronic*	162
⑬ Radio/Navigator*	
⑭ Right seat heating button	139
⑮ Control lamp for deactivated front passenger airbag	44
⑯ Front passenger front airbag	30
⑰ Glove compartment lever	142
⑱ Selector lever	180
⑲ Cup holder compartment	146
⑳ Controls on the centre console:	
– Central locking	97
– ESC	196
– Tyre pressure control*	85
– Park Pilot*	187
– Cigarette lighter/Power socket	150
– Exterior mirror adjustment	133
– Start-Stop*	176
㉑ Handbrake	185
㉒ Hazard warning light switch	121
㉓ Pedals	
㉔ Ignition lock	171
㉕ Steering column control lever*	169 ▶

26	Handle for releasing the bonnet	233
27	Button for opening and closing the front windows	111
28	Safety switch* for the rear windows	111
29	Control* for opening and closing the rear windows	111

**Note**

Some of the items of equipment listed here are fitted only on certain model versions or are optional extras. ■

Instruments

Instrument overview

The instruments display the vehicle operating status.

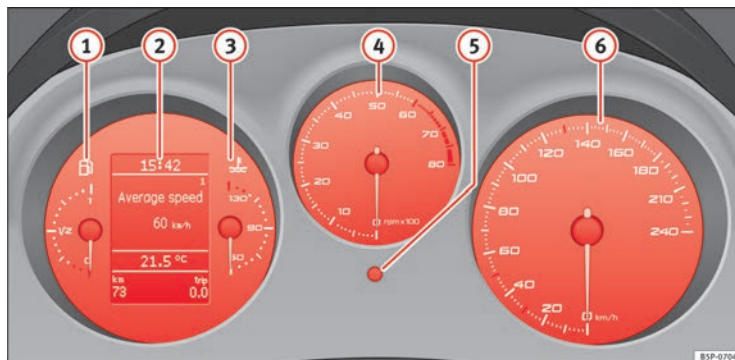

Fig. 34 Detailed view of the dash panel: instrument panel

Detailed view of the dash panel: instrument panel

- ① Fuel gauge ⇒ page 58
- ② Multifunction display ⇒ page 61
- ③ Engine coolant temperature gauge ⇒ page 58
- ④ Rev counter ⇒ page 59
- ⑤ Time adjustment button / trip recorder reset button ⇒ page 59
- ⑥ Speedometer ⇒ page 59

Fuel gauge and reserve indicator



Fig. 35 Instrument panel: fuel gauge

Instrument panel: fuel gauge

The fuel tank has a capacity of approx. 55 litres.

When the needle reaches the reserve area \Rightarrow Fig. 35 (arrow), the warning lamp will light up and an audible warning will sound **reminding the driver to refuel**. At this point there are still 7 litres of fuel in the tank.

The following message appears on the instrument panel display¹⁾ **PLEASE REFUEL [XXX]***.

Engine coolant temperature gauge

This gauge shows the engine coolant temperature.

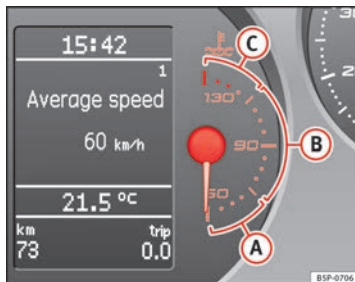

Fig. 36 Instrument panel: engine coolant temperature gauge

Needle in cold zone **(A)**

Avoid high engine speeds and heavy engine loads \Rightarrow Fig. 36.

Needle in normal zone **(B)**

In normal driving conditions, the needle should be in the middle section of the scale. The temperature may also rise when the engine is working hard, especially at high outside temperatures. This is no cause for concern as long as the warning lamp does not light up and no warning message* appears on the instrument panel display.

Needle in warning zone **(C)**

The warning lamp* \Rightarrow Fig. 50 **(2)** will light up if the needle is in the warning zone. The following warning message appears on the instrument panel display¹⁾. **Stop the vehicle and switch off the engine**. Check the coolant level \Rightarrow page 240 \Rightarrow .

¹⁾ Depending on the version of the model.

Even if the coolant level is correct **do not continue driving**. You should obtain technical assistance.



WARNING

When working in the engine compartment, always observe the safety warnings ⇒ page 233.



CAUTION

Accessories in front of the air inlet reduce the cooling effect of the coolant. At high outside temperatures and high engine loads, there is a risk of the engine overheating.

Rev counter

The rev counter displays the engine speed in revolutions per minute.

The start of the red zone ⇒ Fig. 34 ④ indicates the maximum engine speed operating at service temperature. However, it is advisable to change up into a higher gear, move the selector lever to D or lift your foot off the accelerator before the needle reaches the red zone.



CAUTION

To prevent possible engine malfunctions, the rev counter needle should not reach the red zone. The start of the red zone on the dial is different for some engine versions.



For the sake of the environment

Changing up into higher gears sooner, following the recommended gear indications ⇒ Fig. 40 will help you to reduce fuel consumption, emissions and also engine noise.

Speedometer

The speedometer is equipped with a digital odometer and a trip recorder, in addition to a service intervals display.

During the running-in period, the instructions shown on ⇒ page 202 should be followed.

Setting the digital clock*

The digital clock is located in the instrument panel display.

- Turn the setting knob ⇒ Fig. 34 ⑤ clockwise until the first “click” to set the hour. The hour will flash. To change the hour, press the button.
- Turn the setting knob clockwise to the second “click” to set the minutes. The minutes will flash. To change the minutes, press the button.



Note

On Highline versions, the time can also be configured on the Kombi menu.

LPG system*

LPG gauge



Fig. 37 Instrument panel: gas gauge.

LPG system filler level display

The LPG tank →  in the spare wheel well has a capacity of 39 litres at an outside temperature of 15 °C ⇒ page 228, Refuelling with LPG.

The charge level can be checked on the analogue gas gauge located on the instrument panel ⇒ Fig. 37. When the level reaches reserve, a notification text is displayed on the screen. Refill with LPG at the earliest opportunity.

If, while driving in LPG mode, a sudden warning signal is heard and the warning **LPG fault, contact workshop** is displayed on the screen¹⁾, it means that there is a fault in the LPG system. Take the vehicle to a specialised workshop to check the LPG system.

¹⁾ Depending on the model version

²⁾ Optional equipment



WARNING

LPG is a highly explosive and inflammable substance. It may cause severe burns and other injury.

- Due care must be taken to avoid any risk of fire or explosion.
- When parking the vehicle in a closed area (for example in a garage), make sure that there is adequate ventilation, either natural or mechanical, to neutralise the LPG in the event of a leak.



Note

- The values shown in the average fuel consumption and distance to empty indications on the multifunction display (MFI)²⁾ on the instrument panel display¹⁾ are approximate values only.
- Two different consumption values are given on the MFI, depending on whether the vehicle is running in GAS or Petrol mode.
- Please check the fuel level on the fuel level gauge on the instrument panel ⇒ page 58
- If frequent short journeys are made, especially when the outside temperature is low, the vehicle will tend to run on petrol more often than on LPG. Therefore, the petrol tank may empty before the LPG tank. ■

Digital instrument panel display

Display (without warning or information texts)

The display in the instrument panel shows, amongst other things, the mileage and trip recorder as well as the selector lever position.

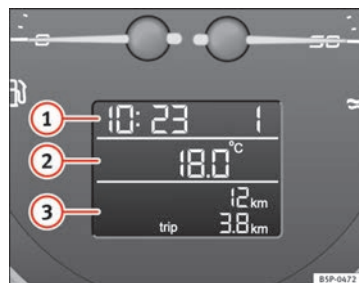

Fig. 38 Detailed view of the instrument panel: screen with different indicators

- ① Digital clock display ⇒ page 59. On the right of the display: Selector lever position display for the automatic gearbox*. The current position of the selector lever or the gear which is engaged (for tiptronic)* is highlighted.
- ② Outside temperature.
- ③ Odometer or flexible service interval display*.

Displayed categories*

The display on the instrument panel shows the mileage and trip recorder as well as the selector lever position.

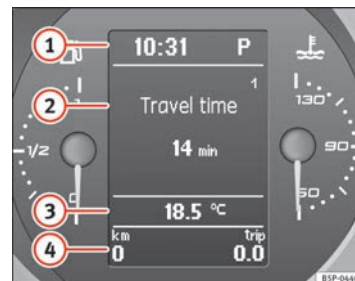

Fig. 39 Digital instrument panel display

- ① Clock: "Setting the time". On the right of the display: Selector lever position display for the automatic gearbox*. The current position of the selector lever or the gear which is engaged (for Tiptronic) is highlighted.
- ② There are optional and automatic displays in this field.
 - **Optional indicators:** e.g. those on the multifunction display (MFI)
 - **Automatic indicators:** Information and warning messages.
 - Menu providing further information and which can be used to make diverse settings are also shown: "Instrument panel menus"
- ③ Outside temperature.
- ④ Odometer or flexible service interval display.

Recommended gear display*

This display helps to save fuel.

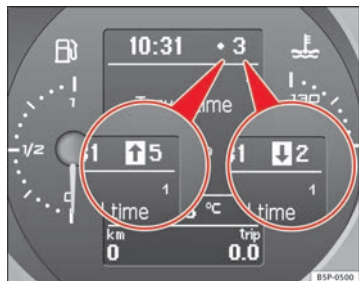

Fig. 40 Gear display

Use the gear display to save fuel. If you are driving in the correct gear, a dot will be shown next to the gear display. If you are not in the correct gear, an arrow will appear next to the gear display indicating whether you should change up or down.



Note

The gear change indication should not be taken into account the acceleration is required (for example when overtaking).

Odometer or flexible service interval display

Odometer

The left-hand counter in the display registers the total amount of distance covered by the vehicle.

The right-hand counter registers the short journeys. The last digit indicates steps of 100 metres. The trip recorder counter may be reset by holding down the reset button for a few seconds.

Service interval display

Vehicles with **Service intervals dependent on time/distance travelled** already have certain service intervals set. The intervals are calculated individually in vehicles with **LongLife service**.

The service interval display only indicates the dates of services that include engine oil change. The dates of all other services, such as Inspection Service or brake fluid change, appear in the sticker on the door pillar or in the Maintenance Programme.

A **Service pre-warning** will appear in the odometer if a service is due soon. A “spanner” symbol appears and the display “km” with the distance that can be driven until the next service appointment is due. The display will change after approximately 10 seconds. A “clock symbol” appears and the number of days until the service appointment should be carried out. The following message is shown in the instrument panel display*:

Service in
[XXXX]
km
or
[XXXX]
days

The service message will disappear approximately 20 seconds after the ignition is switched on or the engine is running. The normal display can be resumed by briefly pressing the reset button on the trip counter or by pressing the **[OK]** button on the steering wheel controls.

With the ignition on, you can **check the current service message** at any moment in the **Vehicle status** menu or turning the reset button to access the service display.

An **overdue service** is indicated by a minus sign in front of the mileage or day information.

Indications for vehicles with LongLife service

Technical progress has made it possible to considerably reduce servicing requirements. With the LongLife System, SEAT ensures that your vehicle only has an interval service when it is necessary. The length of the Interval Services (max. two years) is determined by factors such as conditions under which the vehicle is used and personal driving style.

The service pre-warning will first appear 20 days before the date on which the service is due. The distance travelled is rounded off to the nearest 100 km (miles) and the time to full days. The current service message can only be consulted 500 km (300 miles) after the last service. Until that time, only dashes are displayed.



Note

- If you reset the display manually, the next service interval will be indicated after 15 000 km (10 000 miles) or one year and will not be calculated individually.
- **Do not** reset the display between service intervals as the display will otherwise be incorrect.
- In LongLife Service vehicles, if the battery is disconnected for a long period, the days remaining until the next service cannot be calculated. Therefore, the service message displays on the instrument panel may be incorrect. Take into account the maximum authorised service intervals. ■

Multifunction display (MFI)*

The multifunction display (MFI) shows you information on the journey and fuel consumption.

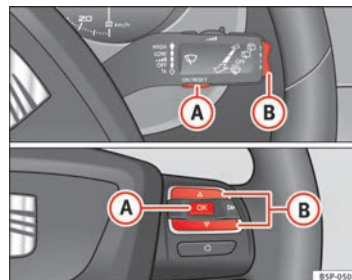

Fig. 41 Rocker buttons A and B. Steering wheel controls.

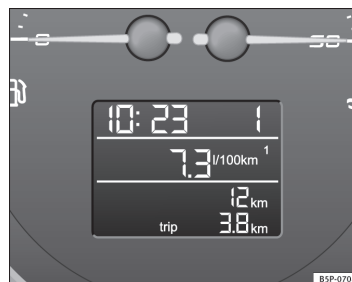

Fig. 42 Digital instrument panel display ▶

The multifunction system uses two automatic memories: **1 - Trip memory** and **2 - Total memory**. The selected memory will be shown in the upper right-hand corner of the display.

Selecting a memory

- When the ignition is on, briefly press button ⇒ Fig. 41 (A) on the windscreen wiper lever to change from one memory to another or press button (A) on the steering wheel controls ⇒ Fig. 41.

Resetting a memory

- Select the memory that you would like to reset.
- Hold down button (A) on the windscreen wiper lever or button (A) on the steering wheel controls for at least 2 seconds.

The **trip memory 1** collects the travel and consumption rates from the moment the ignition is switched on until it is switched off. If the journey is continued within two hours of switching off the ignition, the new values will be added to the existing trip recorder memory. The memory will automatically be deleted if the journey is interrupted for more than two hours.

The **total memory 2** collects the trip data for any number of individual journeys (even if the ignition is switched off for longer than two hours) up to a total of 19 hours and 59 minutes travel time or 1999 km (miles) distance travelled. The memory will automatically be deleted if one of the named values is reached. ■

Information in the multifunction display (MFI)*

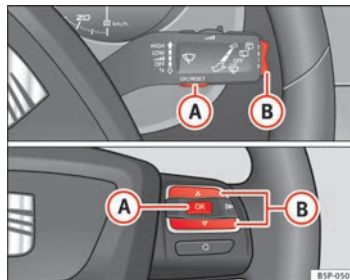

Fig. 43 Rocker buttons A and B. Steering wheel controls.

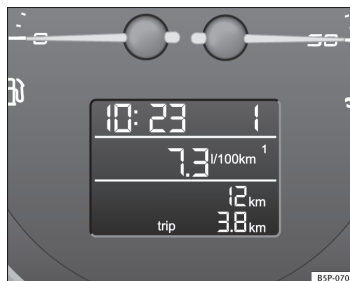

Fig. 44 Digital instrument panel display: average fuel consumption indicator.

You can switch between the following displays in the multifunction display (MFI) by operating rocker switch ⇒ Fig. 43 (B) on the windscreen wiper lever. ►

Memory displays

- Distance
- Average speed
- Driving speed
- Speed warning at --- km/h (mph)
- Journey duration
- Current fuel consumption
- Average fuel consumption
- Fuel range

km (miles) - Distance travelled

The display shows the distance travelled since the ignition was switched on.

The maximum display value in both memories is 1999 km (miles). The memory will automatically be deleted once this value has been reached.

km/h (mph) - Average speed

The average speed will be shown after running a distance of approximately 100 metres. Until then dashes will appear in the display. The display will be updated every 5 seconds while the vehicle is in motion.

km/h (mph) - Driving speed

Driving speed is digitally shown in the display.

Set speed indicator

When driving at the required speed, enter the speed indicator mode and press the button **(A)** (Reset), the display remembers the indicated speed. If the indicated speed is exceeded, a warning message is displayed on the screen¹⁾ and an acoustic signal is given.

This may be deactivated by pressing the button **(A)** (Reset).

¹⁾ Depending on the model version, the message on the screen may vary and may be represented by flashing of the speed indication or by a speed message.

The speed may be altered using the rocker switch **(B)** in steps of 5 km/h (mph) within 5 seconds of the initial memory value.

min - Journey duration

The display shows the amount of time which has elapsed since the ignition was switched on.

The maximum display value in both memories is 19 hours and 59 minutes. The memory will automatically be deleted once this value has been reached.

l/100 km or l/h - Current fuel consumption

The display will show the current fuel consumption in litre/km whilst the vehicle is in motion or in litre/hour when the vehicle is in a stationary position with the engine running.

Using this display you can see how your driving style affects fuel consumption ⇒ page 204.

litre/100 km - Average fuel consumption

The average fuel consumption will be shown ⇒ Fig. 44 after a distance of approximately 100 metres has been travelled. Until then dashes will appear in the display. The display will be updated every 5 seconds while the vehicle is in motion. The amount of fuel used will not be shown.

Km (miles) - Fuel range

The fuel range is calculated using the figures for tank content and current fuel consumption. It shows how far the vehicle can travel using the same conditions as a reference.

Outside temperature indicator

The measurement margin ranges from -40 °C (-40 °F) to +58 °C (+136.4 °F). At temperatures lower than +39 °C (+102.2 °F), an "ice crystal symbol" is displayed and an audible "gong" warning is given if the vehicle is moving ▶

at more than 20 km/h (12 mph) (ice warning). This symbol will flash for about 10 seconds and remains lit until the outside temperature rises above +4 °C (+39.2 °F) or +6 °C (+42.8 °F) if it was already lit.



WARNING

There could be black ice on the road surface even if the “snowflake symbol” is not shown. For this reason you should not rely exclusively on this display - Risk of accident!



Note

When the vehicle is stationary or travelling at very low speeds, the temperature displayed may be slightly higher than the actual outside temperature as a result of the heat radiated from the engine.

Warning or information message in the display

Faults are shown in the display with control lamps and warning/information reports.

The system runs a check on certain components and functions when the ignition is switched on and while the vehicle is moving. Functional faults are indicated by symbols with warning or information messages in the display. An audible warning is given in certain cases.

Warning symbols

There are red warning symbols (priority 1) and yellow warning symbols (priority 2).

Information text

In addition to warning messages given on a fault, you will receive information in the display on procedures or will be asked to carry out certain tasks.



Note

In the case of screens without warning or information messages, faults are indicated exclusively by the control lamps.



Warning messages, Priority 1 (red)

If one of these faults occurs, the warning lamp will flash or light up and will be accompanied by **three audible warnings**. This is a **danger** warning. Stop the vehicle and switch off the engine. Check the fault and correct it. Obtain professional assistance if necessary.

If several priority 1 faults are detected at the same time, the symbols will be displayed one after the other for about 2 seconds at a time and will continue until the fault is corrected.

No menus will be shown in the display for the duration of a priority 1 warning message.

Examples of priority 1 warning messages (red)

- Brake system symbol  with the warning message **STOP BRAKE FLUID INSTRUCTION MANUAL** or **STOP BRAKE FAULT INSTRUCTION MANUAL**.
- Coolant symbol  with the warning message **STOP SEE COOLANT INSTRUCTION MANUAL**.
- Engine oil pressure symbol  with the warning message **STOP ENGINE OIL PRESSURE LOW! INSTRUCTION MANUAL**.

Warning messages, Priority 2 (yellow)

If one of these faults occurs, the warning lamp lights up, and is accompanied by **one audible warning**. The function should be checked as soon as possible.

If several priority 2 warning messages are detected at the same time, the symbols are displayed one after the other for about 2 seconds at a time. After a set time, the information text will disappear and the symbol will be shown as a reminder at the side of the display.

Priority 2 warning messages will not be shown until all **Priority 1** warning messages have been dealt with!

Examples of priority 2 warning messages (yellow):¹⁾

- Fuel warning light with the information text **PLEASE REFUEL**.
- Windscreen washer fluid level symbol  with the information message **ADD WINDSCREEN WASHER FLUID**. Refill the windscreen washer tank
⇒ page 242.

¹⁾ Depending on the version of the model.

Instrument panel menus*

Example of menu use

All the menus on the instrument panel may be used according to the following procedure. The instrument panel menus may vary according to the version of the model.

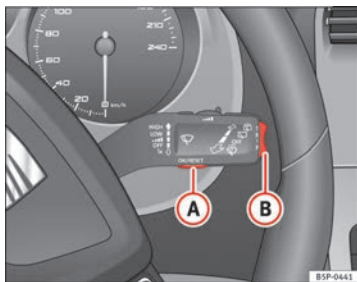

Fig. 45 Windscreen wiper lever: button A to confirm the menu selection and rocker switch B to change the menu

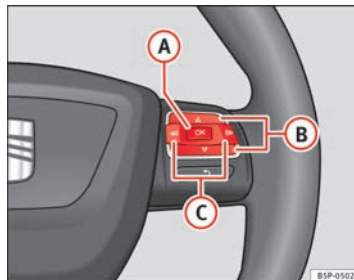

Fig. 46 Steering wheel controls: button A to confirm the menu selection and switch B to change the menu

The setting of a speed warning will be used as an example of how to use the menus. This is a good idea if you are, for example, using winter tyres which are not suited for the top speed of the vehicle.

1. Open the main menu with the MFI lever

- Switch the ignition on.
- Hold down button **(B)** for two seconds to return to main menu from other menu. It may be necessary to repeat this operation until the main menu is displayed.

2. Open the menu “Configuration” with the MFI lever

- To choose an option from the menu, press the upper or lower end of the rocker switch. The selected option is displayed between two lines and there will also be a triangle on the right.
- Select menu **Configuration**.
- Press button **(A)** on the windscreen wiper lever. The **Configuration** menu is opened. ▶

2. Access the Configuration menu with the steering wheel controls

- To access the “Configuration” menu, press button **C** ⇒ Fig. 46 until the menu is displayed. Now you are in this menu.

3. Open the main menu “Winter tyres”

- Select option **Winter tyres** using switch **B**.
- Press the button **A**. The menu **Winter tyres** is opened.

4. Program a speed limit warning

- Use button **B** to select the option **+10 km/h** or **-10 km/h** and press button **B** to either increase or decrease the speed displayed.

5. To activate and deactivate the speed limit warning

- Use switch **B** to select the menu point **On / Off** and press the button to switch the speed warning on or off. If the speed warning is deactivated, three dashes will be displayed ---

6. To close the menu “Winter tyres”

- In the menu select **Back**.

The function “Winter tyres” sends an optical and an acoustic signal when the vehicle reaches the set speed.

Example menu “Winter tyres”

In the menu	Function
Winter tyres	Name of menu displayed
X km/h	The current set speed is displayed
or ---	or dashes will be shown if the function is deactivated.
On / Off	If the function is activated or deactivated
+10 km/h (mph)	The set value increases by 10 km/h (mph)

-10 km/h (mph) The set value decreases by 10 km/h (mph)

Back The menu “Winter tyres” is closed and the last displayed menu is shown.

Note

For electronic and vehicle equipment one or more of these menus will be displayed. ■

Main menu

The menu provides access to the different display functions (only with the MFI lever).

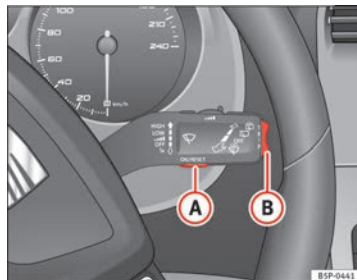

Fig. 47 Windscreen wiper lever (MFI): button A to confirm the menu selection and rocker switch B to change the menu

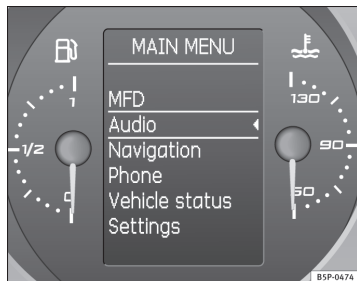

Fig. 48 Digital instrument panel display: Main menu

Open main menu

- Switch the ignition on.
- Press and hold the eject button **(B)** for at least two seconds. It may be necessary to repeat this operation until the main menu is displayed.

Select a menu from the main menu

- To choose an option from the menu, press the upper or lower end of rocker switch **(B)**. The selected option is displayed between two horizontal lines.
- Press button **(A)** to select the entry.

Example of menu use ⇒ page 68

Main menu	Function
Multifunction display	Change to the multifunction display (MFI): "Multifunction display (MFI)"
Audio	This menu displays the available information for the active audio source (radio station, CD audio track / MP3 / USB / iPod / Bluetooth audio ^{a)} / call information ^{a)} .
Navigation	This menu is only available if the vehicle is fitted with a navigation system. The navigation system must be switched on. When the route guidance is activated, the turning arrows and proximity bars are displayed. The appearance is similar to the Navigation system. If the route guidance is not activated, the direction of travel (compass) and the name of the street along which you are driving are shown. ▶

Telephone	This menu is only available in vehicles with radio unit if the vehicle is fitted with the telephone function. In vehicles fitted with a radio navigation system, this menu is available in the central unit (navigator) ⇒ Booklet SEAT Media System 2.1.
Vehicle condition	This menu displays current warning or information texts: "Vehicle status menu" This option flashes when one of these texts is displayed.
Configuration	This option allows the time, the speed warning when using winter tyres, units, language, independent heating, the Light and visibility menu and the Convenience menu to be reset.

a) Only in vehicles fitted with a radio navigation system.



Note

For electronic and vehicle equipment one or more of these menus will be displayed.

Multifunction display menu (MFI)

The multifunction display (MFI) shows you information on the journey and fuel consumption.



Fig. 49 Multifunction display (MFI) instrument panel display.

The multifunction display (MFI) has two automatic memories: **1 - Trip memory and 2 - Total memory**. The selected memory is shown on the upper right hand section of the display ⇒ Fig. 49 at all times.

Open the multifunction display menu

- Select the **Multifunction display** menu from the main menu ⇒ page 70 and press the **OK** button on the windscreen wiper lever or the multifunction steering wheel*.

Selecting a memory

- To change from one memory to another, briefly press button **A** ⇒ Fig. 45 ⇒ page 68 on the windscreen wiper lever or the **OK** button on the multifunction steering wheel ⇒ Fig. 46 ⇒ page 68 while the ignition is switched on. ▶

Resetting a memory

- Select the memory where you wish to erase the values.
- Hold down button **(A)** on the windscreen wiper lever or the **(OK)** button on the multifunction steering wheel* for at least two seconds.

The **trip memory 1** collects the travel and consumption data from the moment the ignition is switched on until it is switched off. If the journey is continued within two hours of switching off the ignition, the new values will be added to the existing trip recorder memory. The memory will automatically be deleted if the journey is interrupted for more than two hours.

The **total memory 2** collects the journey data for any number of individual journeys (even if the ignition is switched off for longer than two hours) up to a total of 19 hours and 59 minutes travel time or 1999 km (miles) distance travelled. The memory will automatically be deleted if one of the named values is reached.

Memory indications

The following data can be viewed on the multifunction display using the rocker switch **(B)** → Fig. 45 ⇒ page 68 on the windscreen wiper lever or by pressing button **(A)** or **(V)** → Fig. 46 on the multifunction steering wheel*.

Personal selection of display

The driver can establish which displays are shown on the instrument panel display as required:

- Select the submenu **Multifunction Display Data** from the **Configuration** menu ⇒ page 73.
- The displays can be activated or deactivated individually by marking the required option and pressing the **(OK)** button on the windscreen wiper lever or the multifunction steering wheel*.

Duration in h and min

The display shows the amount of time which has elapsed since the ignition was switched on.

The maximum display value in both memories is 19 hours and 59 minutes. The memory will automatically be deleted once this value has been reached.

Current fuel consumption in l/100 km or l/hour

The display will show the current fuel consumption in litres/100 km whilst the vehicle is in motion or in litres/hour when the vehicle is in a stationary position with the engine running.

Using this display you can see how your driving style affects fuel consumption ⇒ page 169.

Average fuel consumption in l/100 km

The average fuel consumption will be shown after a distance of approximately 100 metres has been travelled. Until then dashes will appear in the display. The display will be updated every five seconds while the vehicle is in motion. The amount of fuel used will not be shown.

Distance travelled in km (miles)

The display shows the distance travelled since the ignition was switched on.

The maximum display value in both memories is 1999 km (miles). The memory will automatically be deleted once this value has been reached.

Average speed in km/h (mph)

The average speed will be shown after a distance of approximately 100 metres has been travelled. Until then dashes will appear in the display. The display will be updated every five seconds while the vehicle is in motion.

Speed warning at --- km/h (mph)

This function may help you to keep within the speed limits. Press the **(OK)** button on the windscreen wiper lever **(A)** or the multifunction steering wheel* to select the current speed. The instrument panel display gives the selected speed, for example, **Speed warning 120 km/h**. You have five seconds to reset the speed between 30 km/h and 250 km/h using rocker switch **(B)** or buttons **(A)** or **(V)** on the multifunction steering wheel*. Press the **(OK)** button or wait five seconds until the speed is stored and the

warning is activated. If the set speed is exceeded, an audible warning is heard and a warning message is displayed until the speed is reduced to at least 4 km/h (2 mph) below the stored speed. The function is switched off by pressing the **OK** button again. **Speed warning --- km/h (miles)** is now displayed on the instrument panel.



WARNING

There could be black ice on the road surface even if the “snowflake symbol” is not shown. For this reason you should not rely exclusively on this display - Risk of accident!



Note

- There are different instrument panels; therefore the multifunction display may vary.
- When the vehicle is stationary or travelling at very low speeds, the temperature displayed may be slightly higher than the actual outside temperature as a result of the heat radiated from the engine.
- Vehicles with a multifunction steering wheel* do not have buttons on the windscreen wiper lever. The multifunction display can only be controlled from the buttons on the multifunction steering wheel*.

Vehicle status menu

This menu shows warning or information texts

Open Vehicle Condition menu

- Select the option **Vehicle status** from the main menu: “Main menu” and press button **OK** on the windscreen wiper lever **A** ⇒ Fig. 47. **Or**

- Press button **⏪** or **⏩** on the multifunction steering wheel* ⇒ Fig. 46 until the **Vehicle Status** menu is displayed.

Priority 2 warning messages and information texts: “Information and warning messages on the screen” will automatically disappear from the screen after a time and will be stored in the **Vehicle status** menu.

The warning and information texts may be viewed in this menu. If there is no warning or information message, the option **Vehicle status** is not displayed. If there are several messages, each one is shown for a few seconds.

Example of menu use ⇒ page 68



Note

If there are no warning messages, this menu is not available. ■

Configuration menu

This menu is used to make the settings for the vehicle functions.

Open Configuration menu

- Select the option **Configuration** from the main menu: “Main menu” and press button **OK** **A** ⇒ Fig. 45 on the windscreen wiper lever. **Or**
- Press button **⏪** or **⏩** on the multifunction steering wheel* ⇒ Fig. 46 until the **Configuration** menu is displayed.

Example of menu use ⇒ page 68 ▶

Displayed on the screen	Function
Multifunction display data.	This menu is used to establish the data in the multifunction display menu to be displayed on the instrument panel → page 71
Convenience	This menu allows you to make the settings for the convenience functions in the vehicle.
Lights and visibility	From this menu it is possible to alter the vehicle lighting settings.
Time	The hours and minutes of the clock and the navigation system can be changed. Choose between 12 and 24-hour format and change to summer time.
Winter tyres	The menu allows the setting of a speed at which an optical and acoustic warning will be given by the system. You can use this function, for example, if you have fitted winter tyres which are not suited for the top speed of your vehicle. Please see the section "Wheels and tyres".
Language	The display texts and the navigation system texts can be seen in different languages.
Units	This option allows you to select the units for displaying temperature, fuel consumption values and distances.
sel. speed	The instrument panel also displays the speed in another different unit of measurement (mph or km/h) to that given on the speedometer.
Inter Service	Consult service messages and reset service interval display here.
Factory settings	The manufacturer's predefined values for the functions of this menu are restored.
Back^{a)}	This returns to the main menu

^{a)} Only if the windscreen wiper lever is used (MFI).



Note

- For electronic and vehicle equipment one or more of these menus will be displayed.
- SEAT dealerships are able to programme other functions or change the existing functions depending upon the vehicle equipment.
- The Configuration menu is only accessible when the vehicle is at a standstill.

Convenience menu

From this menu it is possible to alter the vehicle convenience settings.

Open menu Convenience

- Choose the option **Configuration** from the main menu and press the button **OK** **(A)** ⇒ Fig. 45 on the windscreen wiper lever.
- Press button **⏪** or **⏩** on the multifunction steering wheel* ⇒ Fig. 46 until the **Configuration** menu is displayed.
- Choose the option **Convenience** from the main menu and press the button **(A)** on the windscreen wiper lever.

Example of menu use ⇒ page 68

Displayed on the screen	Function
Central locking.	One door: individual unlocking activated. Auto lock: The doors are automatically locked when the vehicle is travelling at more than approx 15 km/h (10 mph). Auto unlock: the doors are unlocked when the key is removed from the ignition.
Elec. window control	Opening and closing electric windows: this determines whether to open or close all the windows when the vehicle is unlocked or locked. The open function can also be activated for the driver door only.
Exterior mirror adjust.	If synchronised adjustment is selected, when the driver side exterior mirror is adjusted, the passenger exterior mirror is also moved.
Factory settings	The predefined factory values for the functions of this menu are restored.
Back	This returns to the Configuration menu

**Note**

For electronic and vehicle equipment one or more of these menus will be displayed.

Lights and visibility menu

From this menu it is possible to alter the vehicle lighting settings.

Open Lights and visibility Menu

- Select the option **Configuration** from the main menu: “Main menu” and press button [OK] (A) ⇒ page 68 on the windscreen wiper lever. **Or**
- Press button [▶] or [◀] on the multifunction steering wheel* ⇒ Fig. 46 until the **Configuration** menu is displayed.
- Select the option **Lights & visibil.** from the menu and press button (A) on the windscreen wiper lever.

Example of menu use ⇒ page 68

Displayed on the screen	Function
Coming Home/Leaving Home	This option permits the adjustment of the time during which the headlights remain lit after the vehicle is locked, and also permits the function to be switched on and off
Indicator conf.	The convenience turn signal function can be activated or deactivated here. With the convenience mode activated, the turn signal will blink at least three times when turned on.
Factory settings	The predefined factory values for the functions of this menu are restored.
Back	This returns to the Configuration menu ▶

**Note**

For electronic and vehicle equipment one or more of these menus will be displayed.



Warning lamps

Overview of the warning lamps

The control lamps indicate a number of different functions and possible faults.

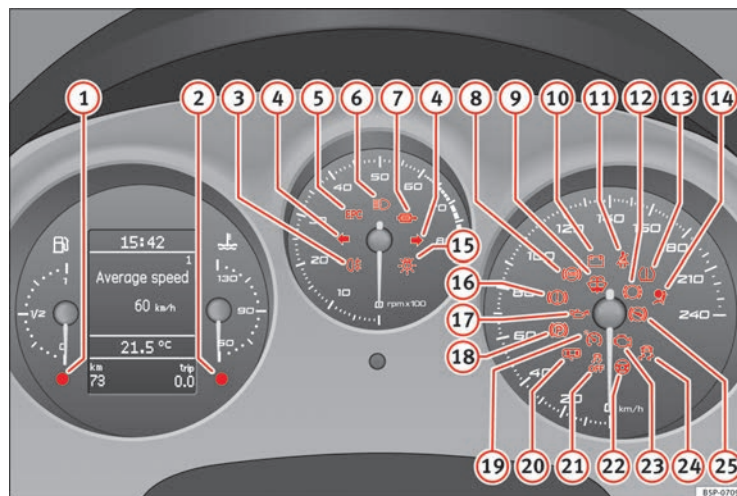

Fig. 50 Instrument panel warning and control lamps. Some of the items of equipment listed here are fitted only on certain model versions or are optional extras. ▶

Item	Symbol	Meaning of control and warning lamps	Further information
①		Fuel level / reserve	⇒ page 81
②		Coolant level / coolant temperature	⇒ page 82
③		Rear fog light switched on	⇒ page 82
④		Turn signals in operation	⇒ page 83
⑤	EPC	Engine fault (petrol engine)	⇒ page 83
		Glow plug system (diesel engines)	⇒ page 83
⑥		Main beam switched on	⇒ page 83
⑦		Soot accumulation in the diesel engine particulate filter	⇒ page 83
⑧		ABS system fault	⇒ page 84
⑨		Windscreen washer fluid level	⇒ page 84
⑩		Alternator fault	⇒ page 85
⑪		Fasten seat belts!	⇒ page 19
⑫		Brake pad worn	⇒ page 85
⑬		Tyre pressure	⇒ page 85

Item	Symbol	Meaning of control and warning lamps	Further information
⑭		Airbag or belt tensioner system fault or airbag disabled	⇒ page 29 ⇒ page 32
⑮		Bulb defective	⇒ page 87
⑯		Brake fluid required or brake system fault	⇒ page 86
⑰		Red: Engine oil pressure	⇒ page 87
		Yellow: If flashing: engine oil sensor faulty If it remains lit: insufficient engine oil	
⑱		Handbrake on	⇒ page 185
⑲		Cruise speed activated (Cruise control)	⇒ page 88
⑳		Door open indicator	⇒ page 88
㉑		If it stays lit: ASR switched off	⇒ page 89 ⇒ page 89 ⇒ page 170
㉒		Electromechanical steering	⇒ page 88
㉓		Fault in the emission control system	⇒ page 88
㉔		If flashing: the Electronic Stability Control (ESC) is in operation or the ASR is in operation	⇒ page 89 ⇒ page 89
		If the following remain lit: ESC or ASR faulty	⇒ page 170
㉕		Selector lever lock (automatic gearbox)	⇒ page 90 ▶

WARNING

- Failure to observe control lamps and warning messages can result in serious personal injury or damage to your vehicle.
- The risk of an accident increases if your vehicle breaks down. Use a warning triangle to draw the attention of other road users in order to prevent danger to third parties.
- The engine compartment is a dangerous area. Before you open the bonnet to work on the engine or in the engine compartment, you must switch the engine off and allow it to cool to reduce the risk of scalding or other injuries. Read and observe the relevant warnings → page 233.



Note



- The appropriate control lamp for a fault will light up in vehicles without warning or information messages in the display.
- In vehicles with warning or information messages on the screen, the appropriate control lamp for a fault will light up and a warning or information message will also appear on the screen.

Overview of control and warning lamps (vehicles with LPG)

The control lamps indicate a number of different functions and possible faults.



Fig. 51 Instrument panel control and warning lamps in vehicles with LPG.

Item	Symbol	Meaning of control and warning lamps	Further information
①		Red: Coolant level/coolant temperature	⇒ page 82
②		Blue: Cold engine warning	⇒ page 82
③		LPG system switched on	⇒ page 175 ▶

**WARNING**

- Failure to observe control lamps and warning messages can result in serious personal injury or damage to your vehicle.
- The risk of an accident increases if your vehicle breaks down. Use a warning triangle to draw the attention of other road users in order to prevent danger to third parties.
- The engine compartment is a dangerous area. Before you open the bonnet to work on the engine or in the engine compartment, you must switch the engine off and allow it to cool to reduce the risk of scalding or other injuries. Read and observe the relevant warnings ⇒ page 233.

**Note**

- The appropriate control lamp for a fault will light up in vehicles without warning or information messages in the display.
- In vehicles with warning or information messages on the screen, the appropriate control lamp for a fault will light up and a warning or information message will also appear on the screen.

Warning symbols

There are red warning symbols (priority 1) and yellow warning symbols (priority 2).



Warning messages, Priority 1 (red)

If one of these faults occurs, the warning lamp will flash or light up and will be accompanied by **three audible warnings**. This is a **danger** warning. Stop the vehicle and switch off the engine. Check the fault and correct it. Obtain professional assistance if necessary.

If several priority 1 faults are detected at the same time, the symbols will be displayed one after the other for about 2 seconds at a time and will continue until the fault is corrected.

No menu will be shown in the display for the duration of a priority 1 warning message.

Examples of priority 1 warning messages (red)

- Brake system symbol  with the warning message **STOP BRAKE FLUID INSTRUCTION MANUAL** or **STOP BRAKE FAULT INSTRUCTION MANUAL**.
- Coolant symbol  with the warning message **STOP SEE COOLANT INSTRUCTION MANUAL**.
- Engine oil pressure symbol  with the warning message **STOP ENGINE OIL PRESSURE LOW! INSTRUCTION MANUAL**.

Warning messages, Priority 2 (yellow)

If one of these faults occurs, the warning lamp lights up, and is accompanied by **one audible warning**. Check the corresponding function as soon as possible although the vehicle may be used without risk.

If several priority 2 warning messages are detected at the same time, the symbols are displayed one after the other for about 2 seconds at a time. After a set time, the information text will disappear and the symbol will be shown as a reminder at the side of the display.

Priority 2 warning messages will not be shown until all **Priority 1** warning messages have been dealt with!

Examples of priority 2 warning messages (yellow):¹⁾

- Fuel warning light with the information text **PLEASE REFUEL**.
- Windscreen washer fluid symbol  with the information text **REFILL WINDSCREEN WASHER FLUID**. Top up the washer fluid level.

¹⁾ Depending on the version of the model.

Information messages displayed on the screen*

Message ^{a)}	Description
SERVICE	The service interval has ended. Take the vehicle to a Technical Service.
IMMOBILISER	Immobiliser system active. The vehicle will not start. Take the vehicle to a Technical Service.
ERROR	Instrument panel faulty. Take the vehicle to a Technical Service.
CLEAN AIR FILTER	Warning: The air filter must be cleaned
NO KEY	Warning: Correct key cannot be found in the vehicle.
KEY BATTERY	Warning: Key battery low. Change the battery.
CLUTCH	Warning: Press the clutch to start. In vehicles with manual gearbox and Start-Stop system.
--> P/N	Warning: Place the selector level in position P/N to start. Only in vehicles with automatic gearbox.
--> P	Warning: Place the selector lever in position P to stop the engine.
STARTING	Warning: The engine starts automatically. Start-Stop system activated.
START MANUALLY	Warning: The engine must be started manually. Start-Stop system activated.
ERROR START-STOP	Warning: Start-Stop system error.
START-STOP IMPOSSIBLE	Warning: Although the Start-Stop system is switched on, the engine cannot be stopped automatically. Not all the necessary conditions are met
START-STOP ACTIVE	Warning: Start-Stop system activated. Vehicle in Stop mode.

¹⁾ Depending on the version of the model.

SWITCH OFF	Warning: Start-Stop system activated. Switch off the ignition when you leave the vehicle.
STOP TRANSMISSION TOO HOT	Warning: Stop the engine. Gearbox overheated.
BRAKE	Warning: To start the engine, press the brake pedal. Only in vehicles with automatic gearbox.
COASTING FUNCTION	Warning: Coasting mode active. Transmission engaged. Only in vehicles with automatic gearbox.
CHECK SAFE-LOCK	Notification of central locking function activated.

^{a)} These messages may vary according to the version of the vehicle model. ■

Fuel level/reserve

This symbol lights up to indicate that the fuel tank is under the reserve level.

It lights up when only 7 litres of fuel remain in the tank. You will also hear an **audible warning**. It reminds you to fuel up the fuel tank as soon as possible ⇒ page 226.

The instrument panel displays the following message¹⁾: **PLEASE REFUEL!** ■

Coolant level* / temperature (red)

The warning lamp lights up if the coolant temperature is too high or if the coolant level is too low.

There is a fault if:

- The warning symbol does not go out again after a few seconds.
- The warning lamp lights up or flashes while the vehicle is moving, and **three acoustic warning signals** ⇒  are emitted.

This means that either the coolant level is too low or the coolant temperature is too high.

Coolant temperature too high

The instrument panel displays the following message¹⁾: **CHECK COOLANT INSTRUCTION MANUAL** ⇒ page 240.

First look at the coolant temperature gauge. The coolant temperature is too high if the needle is over the warning area on the dial. **Stop the vehicle, switch the engine off and wait for it to cool down.** Check the coolant level.

If the coolant level is correct, the overheating may be caused by a malfunction of the radiator fan. Check the radiator fan fuse and have it replaced if necessary ⇒ page 268.

If the control lamp lights up again after driving on for a short distance, **stop the vehicle and switch the engine off.** Contact a Technical Service or a specialised workshop.

Coolant level too low

The instrument panel displays the following message¹⁾: **STOP CHECK COOLANT INSTRUCTION MANUAL.**

First look at the coolant temperature gauge. If the needle is in the normal range, top up with coolant at the earliest opportunity ⇒ .

¹⁾ Depending on the version of the model.



WARNING

- If your vehicle is immobilised for technical reasons, move it to a safe distance from traffic. Turn the engine off, turn the hazard lights on and place the warning triangle.
- Never open the bonnet if you can see or hear steam or coolant escaping from the engine compartment. Risk of scalding. Wait until you can no longer see or hear escaping steam or coolant.
- The engine compartment is a dangerous area. Before carrying out any work in the engine compartment, switch off the engine and allow it to cool down. Always note the corresponding warnings ⇒ page 233.

Coolant temperature (blue)



This lamp lights up when the coolant is below approximately 45 °C. When it exceeds this temperature the lamp turns off.

Rear fog light

This warning lamp lights up when the rear fog light is switched on . For further information see ⇒ page 116.

Turn signals

The control lamp flashes when the turn signals are in operation.

Depending on which turn signal is operating, either the left  or right  turn signal lamp flashes. Both control lamps will flash at the same time when the hazard warning lights are switched on.

If any of both turn signals fails, the warning lamp will start flashing twice faster than normal.

For further information on the turn signals, please see ⇒ page 123.

Engine management* EPC

This warning lamp monitors the engine management system for petrol engines.

The warning lamp **EPC** (Electronic Power Control) lights up when the ignition is switched while the system operation is verified. It should go out once the engine is started.

If there is a fault in the electronic engine management system while you are driving, this warning lamp will light up. Stop the vehicle and seek technical assistance.

Glow plug system/engine fault

The warning lamp lights up to show that the glow plugs are preheating the diesel engine. It flashes if there is an engine fault.

Control lamp is lit

The control lamp  lights up while the glow plug system is preheating. When the warning lamp goes off, the engine should be started straight away.

Control lamp flashes

If a fault develops in the engine management system while you are driving, the glow plug system lamp will flash . Take the vehicle to a specialised workshop as soon as possible and have the engine checked.

Main beam headlights

This control lamp lights up when the main beams are on.

The warning lamp  is switched on once main beams are on or once the headlight flasher is operating.





For further information see ⇒ page 123.

Soot accumulation in the diesel engine particulate filter*



If the lamp  lights up you should help the filter clean itself by driving in the appropriate manner.

To do this, drive about 15 minutes in fourth or fifth gear (automatic gearbox: 5 gear range) at a speed of 60 km/h (40 mph), with the engine running at approximately 2000 rpm. In this way, the pollen build up in the filter is burned. When cleaning is successful, the lamp turns off.

If the lamp  does not turn off, or the three lamps turn on (particulate filter , emission control system fault  and glow plugs ), take the vehicle to a specialised workshop to repair the fault.

WARNING

- Always drive according to the road weather conditions, the terrain and traffic. Driving recommendations should never lead to illegal manoeuvres in surrounding traffic.
- The diesel engine particulate filter may reach extremely high temperatures; it should not enter into contact with flammable materials underneath the vehicle. Otherwise there is a risk of fire.

Anti-lock brake system (ABS)*

A control lamp monitors the ABS.

The control lamp  should light up for a few seconds when the ignition is switched on. It goes out again after the system has run through an automatic test sequence.



There is a fault in the ABS if:

- The control lamp  does not light up when the ignition is switched on.
- The control lamp does not go out again after a few seconds
- The control lamp lights up when the vehicle is moving



The vehicle can still be braked in the normal way, without the ABS function. Take the vehicle to a specialised workshop as soon as possible. For further information on the ABS go to ⇒ page 194.

If a fault occurs in the ABS, the ESC* control lamp will also light up.

Brake system fault

If the ABS warning lamp  lights up together with the brake warning lamp , this indicates not only a fault in the ABS function, but also a possible fault in the brake system ⇒ .

WARNING

- Before opening the bonnet, read and observe the warnings on ⇒ page 233, Working in the engine compartment.
- If the brake system warning lamp  should light up together with the ABS warning lamp , stop the vehicle immediately and check the brake fluid level in the reservoir ⇒ page 245, Brake fluid. If the brake fluid level has dropped below the "MIN" mark you must not drive on. Risk of accident. Obtain technical assistance.
- If the brake fluid level is correct, the fault in the brake system may have been caused by a failure of the ABS system. This could cause the rear wheels to lock quickly when you brake. This could cause the rear to break away. Risk of skidding. Stop the vehicle and seek technical assistance.

Washer fluid*

This warning lamp lights up to indicate that the windscreen washer level is too low.

This serves as a reminder to fill up the reservoir at the earliest opportunity ⇒ page 242. ▶

The following message is shown on the instrument panel display*¹⁾: **REFILL WINDSCREEN WASHER FLUID.**

Alternator

This warning lamp signals a fault in the alternator.

The warning lamp  lights up when the ignition is switched on. It should go out when the engine has started running.

If the warning lamp  lights up while driving, the alternator is no longer charging the battery. You should immediately drive to the nearest specialised workshop.

You should avoid using electrical equipment that is not absolutely necessary because this will drain the battery.

Worn brake pads

If the  symbol lights up, have the front brake pads (and, for safety reasons, the rear pads as well) inspected by a specialised workshop.

¹⁾ Depending on the version of the model.

²⁾ Depending on the model version

Tyre pressure

The tyre pressure control system controls the tyre speed and the frequency spectrum of each tyre.



Fig. 52 Centre console: tyre monitor system button

The tyre control lamp²⁾ compares wheel revolutions and with it, the wheel diameter of each wheel using the ESC. If the diameter of a wheel changes, the tyre control lamp  lights up. The wheel diameter changes when:

- Tyre pressure is insufficient.
- The tyre structure is damaged.
- The vehicle is unbalanced because of a load.
- The wheels of one axle are under more pressure (for example, driving with a trailer or on extreme slopes).
- The vehicle is fitted with snow chains.

- The temporary spare wheel is fitted.
- The wheel on one axle is changed.

Tyre pressure adjustment

Following the modification to tyre pressure or after changing one or more wheels, the button ⇒ Fig. 52 must be kept pressed while the ignition is on until an audible warning is heard and the warning lamp goes out.

If the wheels are under excessive load (for example, driving with a trailer or heavy load), the tyre pressure must be increased to the recommended value for a full load (see the sticker on the inside of the fuel flap). If the tyre monitor system button is pressed down, the new tyre pressures are confirmed.

The tyre pressure control lamp lights up

If the tyre pressure of one or more wheels is much lower than the value set by the driver, the tyre control warning lamp lights up ⇒ .

The tyre pressure control lamp flashes

If the tyre pressure control lamp flashes, this indicates a fault. Go to the nearest specialised workshop.



WARNING

- When the tyre pressure control lamp lights up, reduce speed immediately and avoid any sudden manoeuvre or braking. Stop when possible, and check the tyre pressure and status.
- The driver is responsible for maintaining correct tyre pressures. For this reason, tyre pressure must be regularly checked.
- Under certain circumstances (for example, when driving in a sports-like manner, in winter conditions or on a dirt track) the tyre control lamp may light up or function incorrectly.



Note

If the battery is disconnected, the yellow warning lamp  lights up after turning the ignition on. This should turn off after a brief journey. ■

Brake system*

This warning lamp lights up if the brake fluid level is too low or if there is a fault in the system.

This warning lamp lights up if

- the brake fluid level is too low ⇒ page 245.

The instrument panel displays the following message¹⁾: **STOP BRAKE FLUID INSTRUCTION MANUAL.**



- there is a fault in the brake system.

The instrument panel displays the following message¹⁾: **BRAKE SYSTEM FAULT INSTRUCTION MANUAL.**

This warning lamp can light up together with the ABS system warning lamp. ►

¹⁾ Depending on the version of the model.

**WARNING**

- Before opening the bonnet, read and observe the warnings on ⇒ page 233.
- If the brake warning lamp does not go out, or if it lights up when driving, the brake fluid level ⇒ page 245, Brake fluid in the reservoir is too low. Risk of accident. Stop the vehicle and do not drive on. Obtain technical assistance.
- If the brake warning lamp  lights up together with the ABS warning lamp , the control function of the ABS could be out of action. This could cause the rear wheels to lock quickly when you brake. This could cause the rear to break away. Risk of skidding. Stop the vehicle and seek technical assistance.

Handbrake 

This lamp lights up when the handbrake is applied.

If you drive faster than 6 km/h (4 mph) with the handbrake on, the following message will appear on the instrument panel display¹⁾: **HANDBRAKE ON**. You will also hear an acoustic warning signal ⇒ page 185.

Bulb defect* 

The warning lamp lights up when a bulb in the vehicle's exterior lighting is defective.

The warning lamp  lights up when a bulb in the vehicle's exterior lighting (e.g. left-hand main beam) is defective.

¹⁾ Depending on the version of the model.

The instrument panel displays the following message¹⁾: **LEFT FULL BEAM FAULTY**.

Engine oil pressure 

If this warning lamp is red it indicates that the engine oil pressure is too low.

If this warning symbol starts to flash, and is accompanied by three **audible warnings**, switch off the engine and check the oil level. If necessary, add more oil ⇒ page 236.

The instrument panel displays the following message¹⁾: **STOP ENGINE OIL PRESSURE INSTRUCTION MANUAL**.

If the symbol flashes although the oil level is correct, *do not* drive on. Do not even run the engine at idle speed! Obtain technical assistance.

Checking the oil level 

If the warning lamp is yellow  the engine oil level should be checked as soon as possible. Top up the oil ⇒ page 238 at the next opportunity.

Oil level sensor faulty* 

If the  yellow warning lamp flashes, take the vehicle to a specialised workshop to have the oil level sensor checked. Until then it is advisable to check the oil level every time you refuel.

Cruise speed (Cruise control)*

The warning lamp comes on when the cruise control system is switched on.

The warning lamp  lights up when the cruise control system is switched on. For further information on the cruise control system, see ⇒ page 190. ■

Indicator for open doors or rear lid*

This warning lamp lights up if one of the doors or the rear lid is open.

The warning light  should go off when all the doors are closed correctly.

The system also works when the ignition is switched off. It should go off approx. 15 seconds after the vehicle is locked. ■

Electromechanical steering*

For vehicles with power steering, the level of steering assistance depends on the vehicle's speed and on the steering angle.

The control lamp should light up for a few seconds when the ignition is switched on. It should go out once the engine is started.

If the battery is disconnected, the indicator remains lit, even with the engine running. The warning light only goes off after a distance of approx. 50 m.

There is a fault in the electromechanical steering system if the lamp does not go out or lights up whilst the vehicle is in motion. The warning lamp may appear in two different colours to indicate faults. If it lights yellow, this indicates a minor fault. If it lights red, seek assistance from a specialised workshop immediately, as the steering assistance is not working; in this case you should not keep driving. Stop the vehicle and seek technical assistance. The power steering does not work if the battery is flat or if the engine is off (for example, for towing). You should take into account that you will need considerably more power than normal to steer the vehicle if the power steering is not working correctly or at all.

For those vehicles fitted with ESC*, the "Steering manoeuvre recommendation" function is included. See ⇒ page 196. ■

Emission control system*

This warning lamp monitors the exhaust system.

Control lamp flashes:

When there is misfiring that can damage the catalytic converter. Reduce speed and drive carefully to the nearest specialised workshop to have the engine checked.

The instrument panel displays the following message¹⁾: **EXHAUST GAS SEE WORKSHOP.**



Control lamp is lit:

If a fault has developed during driving which has reduced the quality of the exhaust gas (e.g. lambda probe fault). Reduce speed and drive carefully to the nearest specialised workshop to have the engine checked.

The following message is shown in the instrument panel display: **EXHAUST GAS SEE WORKSHOP.** ■

¹⁾ Depending on the version of the model.

Electronic Stability Control (ESC)* /

There are two control lamps for the electronic stability control. The  lamp provides information concerning the function and the  provides information on the disconnection status

Both lamps come on together when the ignition is switched on and should go out after approx. 2 seconds, which is how long the function check lasts.

This programme includes the ABS, EDL and ASR. This also includes the brake assistance system (BAS), automatic cleaning of the brake discs and the trailer stability programme (TSP).

The warning lamp  has the following functions:

- It flashes whilst driving when the ASR/ESC is activated.
- It will light up continuously if there is a fault in the ESC.
- As the ESC operates in conjunction with the ABS, it will also light up if a fault should occur in the ABS.

If the ESC control lamp  lights up and stays on after the engine is started, this may mean that the control system has temporarily switched off the ESC. In this case the ESC can be reactivated by switching the ignition off and then on again. If the control lamp goes out, this means the system is fully functional.

The  lamp provides information about the disconnection status of the system:

- It stays lit when the ASR is disconnected when pressing the  switch. ■



Differential lock fault (EDL)*

*The EDL operates along with the ABS in vehicles equipped with the Electronic Stability Control (ESC)**

A malfunction in the EDL is indicated by the ABS control lamp . Take the vehicle to a specialised workshop as soon as possible. For further information on the EDL see ⇒ page 197, Electronic differential lock (EDL)*. ■

Traction control system (ASR)* /

The traction control system prevents the driven wheels from spinning when the vehicle is accelerating

There are two warning lamps for the traction control system:  and . Both lamps come on together when the ignition is switched on and should go out after approx. 2 seconds, which is how long the function check lasts.

The  lamp has the following function:

- It flashes when the ASR is working if the vehicle is moving.

If the system is deactivated or if it has any fault, the warning lamp will remain lit. The warning lamp will also light up if a fault should occur in the ABS because the ASR operates in conjunction with the ABS. For further information, see ⇒ page 194, Brakes

The  lamp provides information about the disconnection status of the system:

- It stays lit when the ASR is disconnected when pressing the ASR OFF switch.

By pressing it again, the ASR function is reactivated and the warning lamp switched off. ■

Operating the foot brake

The brake pedal must be depressed when this warning lamp lights up. This is necessary when the automatic gearbox* selector lever is moved out of the positions **P** or **N**. ■

Electronic immobiliser* “Safe”

This warning lamp flashes if an unauthorised key is used.

Inside the key there is a chip that deactivates the electronic immobiliser automatically when the key is inserted into the ignition. The electronic immobiliser will be activated again automatically as soon as you pull the key out of the ignition lock.

The instrument panel displays the following message¹⁾: **IMMOBILISER**. The vehicle cannot be used in that case ⇒ page 172.

The engine can, however, be started if the appropriate coded SEAT genuine key is used.



Note

A perfect operation of the vehicle is ensured if genuine SEAT keys are used. ■

¹⁾ Depending on the version of the model.

Steering wheel controls

General information

The steering wheel includes a multifunction module from where it is possible to control the audio, telephone and radio navigation functions, and the automatic gearbox*, without requiring the driver to be distracted from driving.

There are three versions of the multifunction module:

- Audio version, to control the available audio functions from the steering wheel.
- Audio + Telephone version, to control the available audio functions and the telephone system from the steering wheel.

Both versions may be used to control the Audio system (Radio, Audio CD, mp3 CD, iPod¹⁾/USB¹⁾/SD¹⁾) and the Radio navigation system, in which case they also control the Navigation system.

- Version for automatic gearbox* ⇒ page 183. ■

¹⁾ If fitted in the vehicle.

Audio system

Steering wheel audio version controls

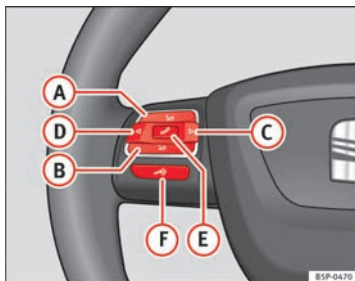

Fig. 53 Controls on the steering wheel

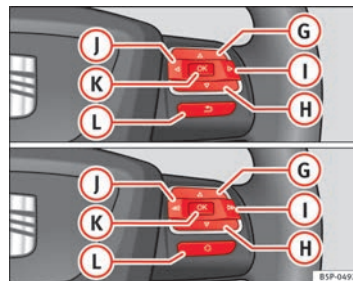

Fig. 54 Steering wheel controls (depending on version of model)

Button	Radio	CD/MP3/USB*/iPod*	AUX → table on page 93
A	Volume up	Volume up	Volume up
B	Volume down	Volume down	Volume down
C	Search for next station	Next track Hold down: Fast forward	No function specified
D	Search for last station	Previous track Hold down: Rewind	No function specified
E	No function specified	No function specified	No function specified
F	Mute	Pause	Mute
G ^{a)}	Operates on instrument panel display Next preset ^{b)}	Operates on instrument panel display Next track ^{b)}	Operates on instrument panel display No function specified ^{b)}
H ^{a)}	Operates on instrument panel display Previous preset ^{b)}	Operates on instrument panel display Previous track ^{b)}	Operates on instrument panel display No function specified ^{b)}

D ^{a)}	Next preset	Change folder	No function specified
	Change menu on instrument panel	Change menu on instrument panel	Change menu on instrument panel
D ^{a)}	Previous preset	Change folder	No function specified
	Change menu on instrument panel	Change menu on instrument panel	Change menu on instrument panel
K	Operates on instrument panel	Operates on instrument panel	Operates on instrument panel
L ^{a)}	Change source	Change source	Change source
	Operates on instrument panel	Operates on instrument panel	Operates on instrument panel

a) Depending on the model version

b) Only if the panel is in Audio menu.

Steering wheel Audio + Telephone version controls

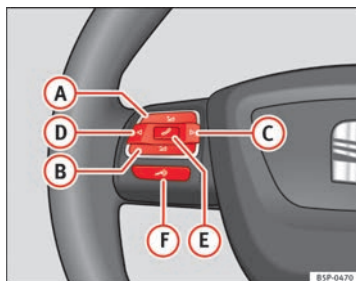

Fig. 55 Controls on the steering wheel

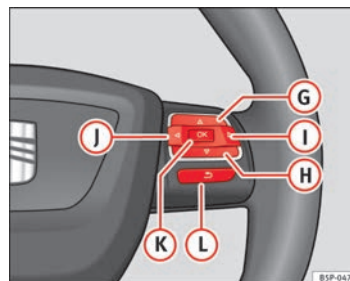

Fig. 56 Steering wheel controls (depending on version of model)

Button	Radio	CD/MP3/USB*/iPod*	AUX	TELEPHONE
A	Volume up	Volume up	Volume up	Volume up
B	Volume down	Volume down	Volume down	Volume down

Ⓒ	Search for next station	Next track Hold down: Fast forward	No function specified	No function specified
Ⓓ	Search for last station	Previous track Hold down: Rewind	No function specified	No function specified
Ⓔ	Access telephone menu on instrument panel	Access telephone menu on instrument panel	Access telephone menu on instrument panel	Make call Accept incoming call End call Hold down: reject incoming call
Ⓕ	Enable voice recognition	Enable voice recognition	Enable voice recognition	Activate voice control/ Interrupt current message/ Deactivate voice control
Ⓖ	Next preset ^{a)}	Next track ^{a)}	No function specified	Previous option in the menu/ list/ selection shown on instrument panel ^{b)}
Ⓕ	Previous preset ^{a)}	Previous track ^{a)}	No function specified	Next option in the menu/ list/ selection shown on instrument panel ^{b)}
Ⓘ	Change menu on instrument panel	Change menu on instrument panel	Change menu on instrument panel	Change menu on instrument panel
Ⓙ	Change menu on instrument panel	Change menu on instrument panel	Change menu on instrument panel	Change menu on instrument panel
Ⓚ	Operates on instrument panel	Operates on instrument panel	Operates on instrument panel	Confirm
Ⓛ	Operates on instrument panel	Operates on instrument panel	Operates on instrument panel	Back to last-opened menu

a) Only if the panel is in Audio menu.

b) Only if the instrument panel is in the "TELEPHONE" menu. Examples of use: Agenda, List of calls, Select numbers, Select letters, Main menu.

Radio navigation system

Steering wheel Audio + Telephone controls

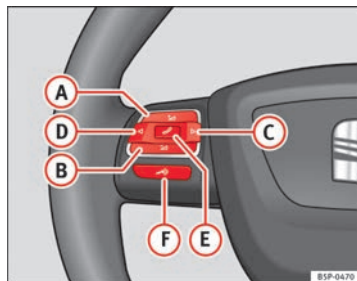

Fig. 57 Controls on the steering wheel

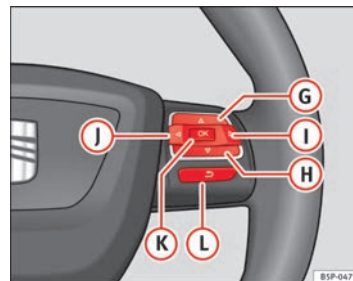

Fig. 58 Steering wheel controls (depending on version of model)

Button	Radio	CD/MP3/USB*/iPod*	AUX	NAVIGATOR	TELEPHONE
A	Volume up	Volume up	Volume up	Volume up	Volume up
B	Volume down	Volume down	Volume down	Volume down	Volume down
C	Search for next station	Next track Hold down: Fast forward	No function specified	No function specified	No function specified
D	Search for last station	Previous track Hold down: Rewind	No function specified	No function specified	No function specified ▶

Ⓔ	No function specified	No function specified	No function specified	No function specified	Accept incoming call (press briefly) Reject incoming call (press and hold down) End ongoing call / establish call (press briefly) Switch to private mode (press and hold down) Redial last number (press and hold down) ^{a)}
Ⓕ	Activation of voice recognition for mobile phone connected to the system (if the phone has this function)* / MUTE	Activation of voice recognition for mobile phone connected to the system (if the phone has this function)* / MUTE	Activation of voice recognition for mobile phone connected to the system (if the phone has this function)* / MUTE	Activation of voice recognition for mobile phone connected to the system (if the phone has this function)* / MUTE	Activation of voice recognition for mobile phone connected to the system (if the phone has this function)* / MUTE
Ⓖ	Next preset ^{b)}	Next track ^{b)}	No function specified	Operates on instrument panel	Operates on instrument panel/No function specified
Ⓕ	Previous preset ^{b)}	Previous track ^{b)}	No function specified	Operates on instrument panel	Operates on instrument panel/No function specified
Ⓘ	Change menu on instrument panel	Change menu on instrument panel	Change menu on instrument panel	No function specified	Change menu on instrument panel
Ⓙ	Change menu on instrument panel	Change menu on instrument panel	Change menu on instrument panel	No function specified	Change menu on instrument panel
Ⓚ	Operates on instrument panel	Operates on instrument panel	Operates on instrument panel	Operates on instrument panel	Operates on instrument panel/No function specified
Ⓛ	Operates on instrument panel	Operates on instrument panel	Operates on instrument panel	Operates on instrument panel	Operates on instrument panel/No function specified

^{a)} For a more detailed description of how to use this button, please refer to the Radio navigation System User Handbook (SEAT Media System 2.1)

^{b)} Only if the panel is in Audio menu.

Opening and closing

Central locking

Basic functions

The central locking system enables you to lock and unlock all doors and the rear lid by just pushing the button.

Description

Central locking can be activated by using any of the following options:

- **the key**, by inserting it into the driver door cylinder and rotating it manually,
- **the central lock button** in the vehicle interior ⇒ page 100.
- **the radio frequency remote control**, using the buttons on the key, ⇒ page 105

Various functions are available to improve the vehicle safety:

- “Safe” locking system
- Selective unlocking system*
- Automatic speed-dependent locking and unlocking system*
- Self-locking system to prevent involuntary unlocking
- Emergency unlocking system

Unlocking the vehicle*

- Press button  ⇒ Fig. 64 on remote control to unlock all the doors and rear lid.

Locking the vehicle*

- Press button  ⇒ Fig. 64 on the remote control to lock all doors and the rear lid or turn the key in the door to lock all doors and the rear lid.



WARNING

- **Never leave children or disabled persons in the vehicle. In case of emergency, they may not be able to leave the vehicle or manage on their own.**
- **Never allow children to play in or around the vehicle. A locked vehicle can be subjected to extremely high and low temperatures, depending on the time of year, thus causing serious injuries/illness. It could even have fatal consequences. Close and lock both the rear lid and all the other doors when you are not using the vehicle.**
- **Always take you car keys with you when you leave the vehicle. Misuse of the keys, for example, by children, may result in serious damage and accident.**
 - The engine may accidentally be started and be out of control.
 - If the ignition is switched on, the electric equipment could be activated with risk of injury, for example, in the electric windows.
 - The doors can be locked using the remote control key. This could become an obstacle for assistance in an emergency situation.
 - Always take the key with you when you leave the vehicle.
- **Never remove the key from the ignition if the vehicle is in motion. The steering lock could suddenly engage, and you would not be able to steer the vehicle.**

**Note**

- While the driver door is open, the vehicle cannot be locked with the remote control. This avoids the user from forgetting his key inside the vehicle.
- If the driver door is unlocked with the key shaft, only the driver door is unlocked, the rest of the doors remain locked. When the ignition is switched on, the door deadlock function is deactivated (although the doors remain locked) and the central lock button is activated. See ⇒ page 107.
- If the central locking or anti-theft alarm are faulty, the driver door control lamp remains lit for approx. 30 seconds after locking the vehicle.
- For anti-theft security, only the driver door is fitted with a lock cylinder. ■

“Safe” Security system*

The deadlock function makes it more difficult to break into the vehicle because the door release lever and the central lock button are not active (depending upon country).

Activating deadlock

- Press *once* the locking button  on the remote control. **Or**
- Turn the key *once* in the driver door lock to lock. A warning lamp in the driver door flashes to indicate the deadlock is working. The warning lamp flashes for approx. two seconds at short intervals and then more slowly.

Deactivating deadlock when the vehicle is locked

- Press the lock button  on the remote control *twice* within two seconds. The vehicle is locked without activating the deadlock. The driver door warning lamp flashes for approx. two seconds and then goes out. After approx. 30 seconds it starts flashing again. ■

The doors can be unlocked and opened from the inside if the deadlock has not been activated. You will have to pull the door release lever once. When the “safe” security system is off, the anti-theft alarm* ⇒ page 107 remains active. The vehicle interior monitoring system* and the anti-tow system are deactivated*.

**WARNING**

Nobody should remain in the vehicle if the anti-tow system deadlock mechanism has been activated. It is not possible to open the doors from the inside. Locked doors could make it more difficult to assist vehicle occupants in the event of an accident. People could become trapped inside in an emergency. ■

Selective unlocking system*

This system allows to unlock either just the driver door or all the vehicle.

Using the remote control, press the unlock button on the remote  once. The Safe system for all the vehicle is deactivated, only the driver door is unlocked and both the alarm and the warning lamp are also turned off.

Unlocking all doors and the luggage compartment

The unlock button on the remote control must be pressed twice  so that all doors and the luggage compartment can be opened.

Press twice within 2 seconds to deactivate the Safe system for all vehicle, to unlock all doors and to use the luggage compartment. The warning lamp and the alarm (only vehicles fitted with one) are turned off. ■

Automatic speed-dependent locking and unlocking system*

This is a safety system which prevent the access to the vehicle from the outside when it is running (for example, when stopped at a traffic light).

Locking

The doors and the rear lid are automatically locked when vehicle speed exceeds 15 km/h (10 mph).

If the vehicle is stopped and one of the doors is opened, when the vehicle moves off again and exceeds a speed of 15 km/h (10 mph), the unlocked door(s) will be locked once more.

Unlocking

The driver door automatically unlocks when the key is removed from the ignition.

Each door can be unlocked and opened independently from the inside (for example, when a passenger gets out of it). To do it, simply operate the lever inside the door.



WARNING

The door handles must not be operated when the vehicle is running: the door would open.

Automatic locking system for involuntary unlocking*

It is an anti-theft system and prevents the unintentional unlocking of the vehicle.

If the vehicle is unlocked and any of the doors (including the rear lid) are opened within 30 seconds, it gets re-locked automatically. This function prevents the vehicle from remaining unlocked if the unlock button is pressed by mistake.

Emergency unlocking system

If the airbags are triggered during an accident, the vehicle is unlocked, except for the luggage compartment. It is possible to lock the vehicle from inside with the central locking, after turning the ignition off and back on again.

If the doors must be locked from the outside, see "Emergency locking of the doors"



Central lock button

The central lock button allows you to lock and unlock the vehicle from the inside.



Fig. 59 Detailed view of the centre console: central lock button

Locking the vehicle

- Press the button  ⇒ .

Unlocking the doors

- Press button .

The central lock button is still operative when the ignition is switched off. Except when the Safe security system is activated.

Please note the following if you lock your vehicle with the central lock button:

- Locking the doors and rear lid prevents access from the *outside* (for safety reasons, e.g. when stopped at a traffic light).
- The driver door and/or front passenger door cannot be locked if any of the vehicle doors (except the rear lid) are open. This avoids the user from forgetting his key inside the vehicle.
- Repeated operation of the central locking will deactivate the central lock button for 30 seconds. Once this time has passed, the button is operative again.
- There is a danger of leaving the key inside the vehicle if the vehicle is locked by the central locking button when the driver door is closed and any of the rear doors open. On closing any of the rear doors, the vehicle locks and the keys remain inside it.
- All doors can be locked separately from inside the vehicle. Do this by pulling the door release lever *once*.





WARNING

- If the vehicle is locked, children and disabled people may be trapped inside it.
- The central lock button is not operative in the following cases:
 - When the vehicle is locked from the outside (with the remote control or the key).
 - While the ignition is not activated after unlocking the door lock cylinder with the key.



Note

- Vehicle locked, amber button .
- Vehicle unlocked, red button .

Unlocking and locking - Manual personalisation

Activating selective unlocking

With the driver door open, turn the key to unlock for approx. 3 s

Deactivating selective unlocking

With the driver door open, turn the key to lock for approx. 3 s

The turn signal lamps flash to confirm activation or deactivation.

Activation of automatic locking

Press the lock button  on the central locking button for 3 seconds.

Deactivation of automatic locking

Press the unlock button  on the central locking button for 3 seconds.

The lock button lamp flashes to confirm activation or deactivation.

Emergency manual locking

This permits mechanical locking of the doors in case of central locking system failure.

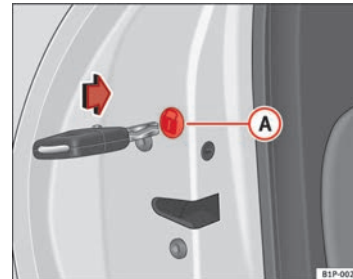



Fig. 60 Locking the doors manually

Locking the driver door manually

Insert the key in the door lock cylinder and rotate in a clockwise direction for the left hand side door and anticlockwise for the right hand side door.

Once the door has been closed it can no longer be opened from the outside.

Manual (emergency) locking of the remaining doors

Open the door and remove the cap  => Fig. 60 printed with a lock image. This will expose a circular element with a groove in the centre. Insert the key into the groove and rotate the element clockwise for the right hand side doors and anticlockwise for the left hand side doors.

Replace the cap and close the door. Once the door has been closed it can no longer be opened from the outside.

Unlocking the manually (emergency) locked driver door

Insert the key in the door lock cylinder and rotate anticlockwise for the left hand side doors and clockwise for the right hand side doors.

The door lock is released and the door may be opened using the exterior door handle.

Unlocking the remaining manually (emergency) locked doors

First the driver door must be unlocked to gain entry to the vehicle. Operate the internal door handle for the required door. If the childproof lock is activated on the rear doors, when the interior door release lever is operated the door is unlocked but does not open. The door must be opened from the outside.

**Note**

Once the vehicle is open, if you wish to lock it manually (emergency locking), repeat the previous instructions. ■

Childproof lock

The childproof lock prevents the rear doors from being opened from the inside. This system prevents minors from opening a door accidentally while the vehicle is running.



Fig. 61 Childproof lock on the left hand side door



Fig. 62 Childproof lock on the right hand side door ▶

This function is independent of the vehicle electronic opening and locking systems. It only affects rear doors. It can only be activated and deactivated manually, as described below:

Activating the childproof lock

- Unlock the vehicle and open the door in which you wish to activate the childproof lock.
- With the door open, rotate the groove in the door using the ignition key, clockwise for the left hand side doors, and anticlockwise for the right hand side doors ⇒ Fig. 61 ⇒ Fig. 62.

Deactivating the childproof lock

- Unlock the vehicle and open the door whose childproof lock you want to deactivate.
- With the door open, rotate the groove in the door using the ignition key, clockwise for the right hand side doors, and anticlockwise for the left hand side doors ⇒ Fig. 61 ⇒ Fig. 62.

Once the childproof lock is activated, the door can only be opened from the outside. The childproof lock can be activated and deactivated by inserting the key in the groove when the door is open, as described above.

Keys

Set of keys

The set of keys includes a remote control, a key without a remote control and a plastic key tab.*

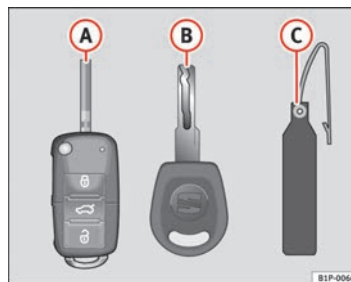

Fig. 63 Set of keys

The set of keys belonging to your vehicle consists of the following items:

- one remote control key ⇒ Fig. 63 (A) with folding key bit,
- one key without remote control (B),
- a plastic key tab* (C).

Duplicate keys

If you need a replacement key, go to a Technical Service with your vehicle identification number. ▶

**WARNING**

- An incorrect use of the keys can cause serious injuries.
- Never leave children or disabled persons in the vehicle. In case of emergency, they may not be able to leave the vehicle or manage on their own.
- An uncontrolled use of the key could start the engine or activate any electric equipment (e.g. electric windows), causing risk of accident. The doors can be locked using the remote control key. This could become an obstacle for assistance in an emergency situation.
- Never forget the keys inside the vehicle. An unauthorised use of your vehicle could result in injury, damage or theft. Always take the key with you when you leave the vehicle.
- Never remove the key from the ignition if the vehicle is in motion. Otherwise, the steering could suddenly block and it would be impossible to steer the vehicle.

**CAUTION**

There are electronic components in the remote control key. Avoid wetting and hitting the keys. ■

Radio frequency remote control

Locking and unlocking the vehicle

The radio frequency remote control key is used to lock and unlock the vehicle from a distance.

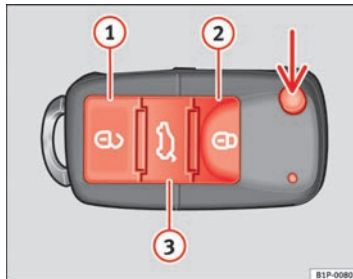

Fig. 64 Assignment of buttons on the remote control key

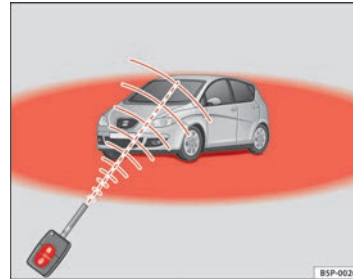

Fig. 65 Range of the radio frequency remote control

Using the button \Rightarrow Fig. 64 (arrow) on the control, the key blade is released.

Unlocking the vehicle \Rightarrow Fig. 64 ①.

Locking the vehicle \Rightarrow Fig. 64 ②.

Unlocking the rear lid. Press button \Rightarrow Fig. 64 ③ until all the turn signals on the vehicle flash briefly. When the unlocking button \Rightarrow Fig. 64 ③ is pressed, you have 2 minutes to open the door. Once this time has passed, it will lock again.

Also, the battery indicator on the key \Rightarrow Fig. 64, will flash.

The remote control transmitter and the batteries are integrated in the key. The receiver is inside the vehicle. The maximum range depends on different factors. The range is reduced as the batteries start to lose power.

Selective unlocking*



When the button \Rightarrow Fig. 64 ①, is pressed once, the driver door is unlocked, all others remain locked.

Press the button \Rightarrow Fig. 64 ① twice to unlock all doors. ▶

**WARNING**

- An improper use of the key can cause serious injuries.
- Never leave children or disabled persons in the vehicle. In case of emergency, they may not be able to leave the vehicle or manage on their own.
- Never forget the keys inside the vehicle. Otherwise, this could result in serious injuries, accidents or even the theft of your vehicle. Always take the key with you when you leave the vehicle.
- An uncontrolled use of the key could start the engine or activate any electric equipment (e.g. electric windows), causing risk of accident. The vehicle can be locked when using the remote control key. This could complicate the aid in case of emergency.

**Note**

- The radio frequency remote control can be programmed by means of pressing the unlocking button once; as a result, only the driver door will unlock. When the button is pressed once more, all doors and the rear lid will be unlocked.
- The radio frequency remote control functions only when you are in range → Fig. 65 (red area).
- If the vehicle is unlocked using the   button, it will lock again automatically if any of the doors or the rear lid are not opened within 30 seconds after unlocking it. This function prevents the vehicle from remaining unlocked if the unlock button is pressed by mistake.
- If the vehicle cannot be opened and closed using the radio frequency remote control, the remote control key will have to be re-synchronised → page 106.

Changing the battery

If the battery indicator does not flash when the buttons are pushed, the battery must be replaced.

**CAUTION**

The use of inappropriate batteries may damage the radio frequency remote control. For this reason, always replace the dead battery with another of the same size and power.

**For the sake of the environment**

Used batteries must be disposed of at an appropriate waste facility or through an authorised service, given that their components can affect the environment.

Synchronising the remote control key

If it is not possible to unlock or lock the door with the remote control, it should be re-synchronised.

- Press the  → Fig. 64 button on the remote control.
- Then close the vehicle using the key bit **within one minute**.

It is possible that the vehicle could no longer be opened and closed with the remote control if the button  is repeatedly pressed outside of the effective range of the radio frequency remote control. The remote control key will have to be resynchronised.

Spare remote control keys are available in your Technical Service, where they must be matched to the locking system.

Up to four remote control keys can be used.

Anti-theft alarm system*

Description of anti-theft alarm system*

The anti-theft alarm triggers if unauthorised movements are detected around the vehicle.

The anti-theft alarm makes it more difficult to break into the vehicle or steal it. Audible and visible alarms are triggered if the vehicle is opened using the key, or if unauthorised access to the vehicle is forced.

The anti-theft alarm system is automatically switched on when locking the vehicle. The system is then primed.

When does the system trigger an alarm?

The system triggers an alarm if the following unauthorised actions are carried out when the vehicle is locked:

- Opening the vehicle mechanically using the key and with the ignition off
- Opening a door
- Opening the bonnet
- Opening the rear lid
- Switching on the ignition
- Movements in the vehicle interior
- Undue manipulation of the alarm
- Battery handling

The acoustic signals sound and the turn signals flash for approx. 30 seconds. This may be repeated up to 10 times depending on the country.

Opening the doors mechanically (emergency opening)

If the radio frequency remote control function fails, you will have to use the key to unlock the vehicle. This is done as follows:

- Unfold the key by pressing the button shown by the (arrow).
- Use the lock on the driver door to unlock the vehicle. The anti-theft alarm system remains active, but an alarm is not triggered immediately.
- Switch on the ignition within 15 seconds. When the ignition is switched on, the electronic immobiliser recognises a valid vehicle key and deactivates the anti-theft alarm system. If you do not switch on the ignition within 15 seconds, the alarm is triggered.

Opening all the doors in manual mode

In vehicles without alarm, when opening the driver door manually all the doors are opened.

How to switch the alarm off

When the vehicle is unlocked via the unlocking button of the radio frequency remote control or when the key is inserted in the ignition lock.



Note

- If, after the audible warning goes off, another monitored area is accessed (e.g. the rear lid is opened after a door has been opened), the alarm is triggered again.
- Vehicle monitoring remains active even if the battery is disconnected or not working for any reason.
- The alarm is triggered immediately if one of the battery cables is disconnected while the alarm system is active. ■

Volumetric sensor*

Monitoring or control function incorporated in the anti-theft alarm which detects unauthorized vehicle entry by means of ultrasound.*

The system consists of 3 sensors, 2 emitters and a receptor. ►

Activation

- It is automatically turned on with the anti-theft alarm, when the vehicle is locked mechanically with the key and when the button  on the remote control is used.

Deactivation

- Press the button  on the remote control twice. Only the volumetric sensor is deactivated. The alarm system remains activated.

**WARNING**

- The Safe security system remains deactivated if the volumetric sensor is deactivated.
- For those vehicles in which a separation screen is fitted, the alarm will not function correctly due to interference with the sensor.

**Note**

- If the alarm has been triggered by the volumetric sensor, this will be indicated by a flashing of the warning lamp on the driver door when the vehicle is opened. This flashing will be different to that for an activated alarm. ■

Rear lid

Unlocking and locking

The rear lid opening system operates electrically. It is activated by using the handle on the rear lid.

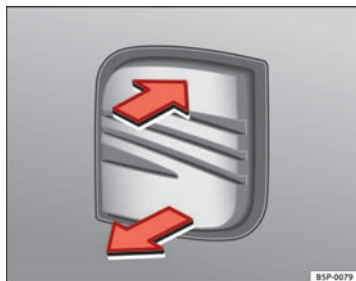

Fig. 66 Rear lid: opening from the outside

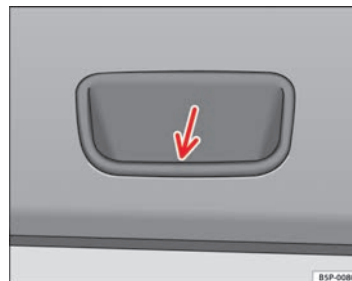

Fig. 67 Close-up of the inside trim of the rear lid: hand grip

Opening the rear lid

- Pull on the release lever and lift the rear lid ⇒ Fig. 66. The rear lid will automatically open.

Closing the rear lid

- Hold the rear lid by one of the two handles on the interior lining and close it, pushing slightly.

This system may or may not be operative, depending on the situation of the vehicle.

If the rear lid is locked then it cannot be opened, however if it is unlocked then the opening system is operative and the rear lid may be opened.

To lock/unlock, press the button  or the button **1** on the remote control key.

A warning appears on the instrument panel display if the rear lid is open or not properly closed.* An audible warning is also given if the rear lid is open when the car is driven faster than 6 km/h*.

**WARNING**

- Always close the rear lid properly. Risk of accident or injury.
- Do not close the rear lid by pushing it down with your hand on the rear window. The glass could smash. Risk of injury!
- Ensure the rear lid is locked after closing it. If not, it may open unexpectedly while driving.
- Never allow children to play in or around the vehicle. A locked vehicle can be subjected to extremely high and low temperatures, depending on the time of year, thus causing serious injuries/illness. It could even have fatal consequences. Close and lock both the rear lid and all the other doors when you are not using the vehicle.
- Closing the rear lid without observing and ensuring it is clear could cause serious injury to you and to third parties. Make sure that no one is in the path of the rear lid.
- Never drive with the rear lid open or half-closed, exhaust gases may penetrate into the interior of the vehicle. Danger of poisoning!
- If you only open the rear lid, do not leave the key inside. The vehicle will not be opened if the key is left inside.

Emergency opening

This allows the vehicle to be opened if the central locking does not operate (for example, if the battery is flat)

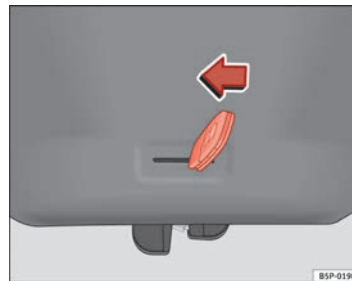

Fig. 68 Rear lid: emergency open

There is a groove in the luggage compartment allowing access to the emergency opening mechanism.

Opening the rear lid from inside the luggage compartment

- Insert the key in the groove and unlock the locking system, turning the key from right to left, as shown by the arrow ⇒ Fig. 68. ■

Windows

Opening or closing the electric windows

The front and rear electric windows can be operated by using the controls on the driver door.

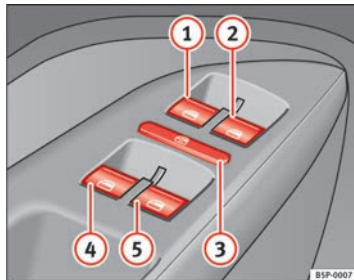

Fig. 69 Detail of the driver door: controls for the front and rear windows

Opening and closing the windows

- Press the button to open the window.
- Pull button to close the window ⇒ .

Always close the windows fully if you park the vehicle or leave it unattended ⇒ .

You can use the electric windows for approx. 10 minutes after switching off the ignition if neither the driver door nor the front passenger door has been opened and the key has not been removed from the ignition.

Buttons on the driver door

- ① Button for window in front left door
- ② Button for window in front right door

Buttons for rear windows*

- ③ Safety switch for deactivating the electric window buttons in the rear doors
- ④ Button for window in rear left door
- ⑤ Button for window in rear right door

Safety switch *

Safety switch ③ on the driver door can be used to disable the electric window buttons in the rear doors.

Safety switch not pressed: buttons on rear doors are activated.

Safety switch pressed: buttons on rear doors are deactivated.

WARNING

- Incorrect use of the electric windows can result in injury.
- Never close the rear lid without observing and ensuring it is clear, to do otherwise could cause serious injury to you and third parties. Make sure that no one is in the path of a window.
- Always take the vehicle key with you when you leave the vehicle.
- Never leave children or disabled persons in the vehicle, particularly if they have access to the keys. An uncontrolled use of the key could start the engine or activate any electric equipment (e.g. electric windows), causing risk of accident. The doors can be locked using the remote control key. This could become an obstacle for assistance in an emergency situation.

 **WARNING (Continued)**

- The electric windows will work until the key has been removed from the ignition and one of the front doors has been opened.
- If necessary, use the safety switch to disable the rear electric windows. Make sure that they have been disabled.

**Note**

If the window is not able to close because it is stiff or because of an obstruction, the window will automatically open again ⇒ page 112. If this happens, check why the window could not be closed before attempting to close it again.

One-touch opening and closing

One-touch opening and closing means you do not have to hold down the button.

One-touch closing

- Pull up the window button briefly up to the second position. The window closes fully.

One-touch opening

- Push down the window button briefly up to the second position. The window opens fully.

Restoring one-touch opening and closing

- Close all windows.
- Use the key to lock the vehicle from outside and hold the key in the lock position for at least one second. The one-touch function is now ready for operation.

The buttons ⇒ Fig. 69 ① and ② have two levels for opening the window and two for closing it. This makes it easier to open and close windows to the desired position.

One-touch closing does not work when the ignition has been switched off, even if the key is in the ignition.

The automatic open and close function will not work if the battery has been temporarily disconnected, or if the battery is flat. The function then has to be reactivated.

The one-touch function and roll-back function will not work if there is a malfunction in the electric windows. Contact a specialised workshop. ■

Roll-back function

The windows have a roll-back function. This reduces the risk of injuries when the windows are closing.

- If a window is obstructed when closing automatically, the window stops at this point and lowers immediately ⇒ .
- If this happens, check immediately (within 10 seconds) why the window could not be closed before attempting to close it again. After 10 seconds the normal automatic function resumes.
- If the window is still obstructed, the window will stop at this point.
- If there is no obvious reason why the window cannot be closed, try to close it again within 5 seconds.

If you wait longer than 5 - 10 seconds, the window will open fully when you operate one of the buttons. One-touch closing is reactivated.

The one-touch function and roll-back function will not work if there is a malfunction in the electric windows. Contact a specialised workshop. ▶

! WARNING

- Incorrect use of the electric windows can result in injury.
- Always take the ignition key with you when leaving the vehicle, even if you only intend to be gone for a short time. Please ensure that children are never left alone inside the vehicle.
- The electric windows will work until the key has been removed from the ignition and one of the front doors has been opened.
- Never close the rear lid without observing and ensuring it is clear, to do otherwise could cause serious injury to you and third parties. Make sure that no one is in the path of a window.
- Never allow people to remain in the vehicle when you close the vehicle from the outside. The windows cannot be opened even in an emergency.

i Note

The roll-back function is deactivated if the windows are closed from the outside of the vehicle using the ignition key for convenience closing
⇒ page 113.

Convenience opening and closing*

Using the door lock

- Hold the key in the door lock of the driver door in either the locking or the unlocking position until all windows are either opened or closed.
- Release the key to interrupt this function.

Using the remote control

- Push the lock or unlock button on the remote control for about 3 seconds. All windows which function electrically will be either opened or closed.
- Release the unlock button to interrupt the function.
- Once the windows are completely closed, the turn signals will flash.

Sliding/tilting sunroof*

Opening and closing the sliding/tilting roof

The sliding/tilting sunroof is opened and closed using the rotary knob when the ignition is switched on.

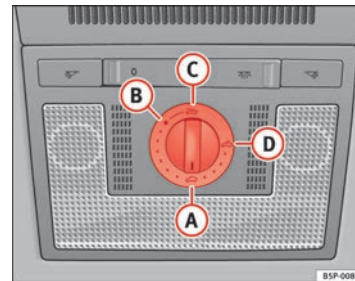

Fig. 70 Roof lining description: sliding/tilting sunroof rotary knob

Closing the sliding/tilting sunroof

- Turn the rotary button to position **A** ⇒ Fig. 70 ⇒ .

Opening the sliding/tilting sunroof

- Turn the rotary button to position **B**. The sunroof opens to the convenience position where wind noise is reduced.
- To open the roof further, turn the switch to position **C** and hold the switch in this position until the roof opens to the desired position.

Tilting the sliding/tilting sunroof

- Turn the rotary button to position **D**.

Always close the sliding/tilting sunroof fully if you park the vehicle or leave it unattended ⇒ .

The sliding/tilting sunroof can be operated for up to about 10 minutes after the ignition has been switched off, provided the driver door and the front passenger door are not opened.

Sun visor

The sun visor is opened together with the sliding/tilting sunroof. If required, it can be closed by hand when the sunroof is closed.

WARNING

- **Incorrect use of the sliding/tilting sunroof can result in injury.**
- **Never close the sliding/tilting sunroof without checking there are no obstructions, to do otherwise could cause serious injury to you and others. Make sure that no one is in the path of the sliding/tilting sunroof.**
- **Always take the vehicle key with you when you leave the vehicle.**

WARNING (Continued)

- **Never leave children or disabled persons in the vehicle, particularly if they have access to the keys. Unsupervised use of a key could mean that the engine is started or that electrical equipment is used (e.g. electric sliding/tilting sunroof). Risk of accident! The doors can be locked using the remote control key. This could become an obstacle for assistance in an emergency situation.**
- **The sliding/tilting sunroof continues to function until one of the front doors is opened and the key removed from the ignition.**

Convenience closing*

Using the door lock

- Hold the key in the door lock of the driver door in the locking position until the sliding/tilting sunroof is closed.
- Release the key to interrupt this function.

Using the remote control

- Push the lock button on the remote control for about 3 seconds. The sliding/tilting sunroof is closed.
- Release the unlock button to interrupt the function.
- When the sliding/tilting sunroof has closed completely, the turn signals flash once.



Note

The sliding/tilting sunroof rotary knob remains in the last position selected if the roof is closed using convenience closing from outside the vehicle and will have to be re-positioned the next time you drive.

Roll-back function of the sliding/tilting sunroof*

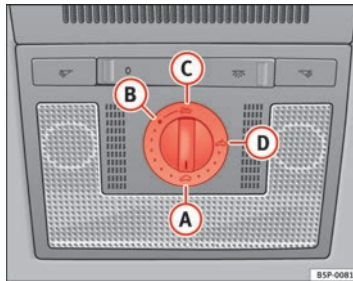

Fig. 71 Roof lining description: sliding/tilting sunroof rotary knob

The sliding/tilting sunroof has a *roll-back function* which prevents larger objects getting trapped when the roof is closed. The roll-back function does not prevent fingers getting pinched against the roof opening. The sliding/tilting sunroof stops and opens again immediately if it is obstructed when closing.

If the sliding/tilting sunroof has been opened again by the roll-back function, it can be closed only by pressing the rotary button at the front in position **A** ⇒ Fig. 71 until the sliding/tilting sunroof has closed fully. **Please note that the sunroof will now close without the roll-back function.** ■

Lights and visibility

Lights

Switching lights on and off



Fig. 72 Detailed view of the dash panel: lights, fog lights and rear fog light switch

Switching on the side lights

- Turn the light switch \Rightarrow Fig. 72 to position \Rightarrow .



Switching on dipped beam headlights

- Turn the light switch to position \Rightarrow .



Switching off the lights

- Turn the light switch to position 0.

Switching on front fog lights*

- Pull the switch out of position \Rightarrow  or \Rightarrow  to the first stop. The symbol \Rightarrow  in the light switch lights up.

Switching on the rear fog lights (vehicles with front fog lights)

- Pull the switch out of position \Rightarrow  or \Rightarrow  to the second stop \Rightarrow . A control lamp lights up in the instrument panel.

Switching on the rear fog lights (vehicles with no front fog lights)

- Pull the light switch from position \Rightarrow  to the last stop. A control lamp lights up in the instrument panel.



WARNING

Never drive with just the side lights on. Risk of accident. The side lights are not bright enough to illuminate the road ahead and to ensure that other road users are able to see you. Always use your dipped beam headlights if it is dark or if visibility is poor.



Note

- The dipped beam headlights will only work with the ignition on. The side lights come on automatically when the ignition is turned off.
- If the lights are left on after the key has been taken out of the ignition lock, an audible warning will sound while the driver door remains open. This is a reminder to switch the lights off.
- The rear fog light is so bright that it can dazzle drivers behind you. You should use the rear fog light only when visibility is very poor. \blacktriangleright

- If you are towing a trailer equipped with a rear fog light on a vehicle with a factory-fitted *towing bracket*, the rear fog light on the vehicle will automatically be switched off.
- The use of the lighting described here is subject to the relevant statutory requirements.
- Depending on weather conditions (very cold or wet), the front and rear lights and the indicators may be temporarily misted. This has no influence on the useful life of the lighting system. The lights will soon demist when they are switched on.

Automatic lighting*



Fig. 73 Automatic lighting

Activation

- Rotate the switch to the position “Auto”, this indication will light up.

Deactivation

- Turn the light switch to 0.

Automatic lighting

If automatic headlight control is switched on, dipped beam headlights are automatically switched on by a photosensor if you drive into a tunnel, for example.

The rain sensor switches on the dipped beam headlights when the windscreen wipers have been operating continuously for a few seconds and it switches the lights off when the continuous or interval wipe is switched off for some minutes ⇒ page 130.

When the automatic dipped beam light control is connected but the dipped beam lights are off, the warning lamp **AUTO** lights up on the light control ⇒ Fig. 73. If the automatic control switches on the dipped lights, the instrument and control lighting is also switched on.



WARNING

- Even if the automatic headlight control is switched on, the dipped beam headlights will not be switched on with fog. Therefore, the dipped beam must be switched on manually.



Note

- For those vehicles with the automatic headlight system, when the key is removed from the ignition, the audible warning will only sound if the light control is in the position ☞ or ☞ if the vehicle is not fitted with the coming home function.
- If the daylight driving automatic light function is switched on, the fog lights or rear fog light cannot be switched on in addition.
- The use of the lighting described here is subject to the relevant statutory requirements.
- Do not put stickers on the windscreen in front of the sensor. This may cause disruptions or faults in the automatic lighting system.
- To avoid damage to the tail lights, the lights mounted on the rear lid go off when the rear lid is opened (depending on the country).

Daytime driving lights*

The daytime light reduces the risk of accidents by increasing the visibility of the vehicle. The daytime running lights are enabled automatically when the ignition is switched on. It is automatically switched off when the side lights are turned on.

Daytime driving lights (halogen lamps)¹⁾

The daytime lights increase road safety in vehicles fitted with halogen lamps. These include the dipped, side and number plate lights.

The daytime lights are switched on each time the ignition is turned on if the light setting is in position **0** or **AUTO**. Depending upon the model, a control lamp \Rightarrow on the light control switch or the lighting up of the instrument panel will indicate that the daytime lighting is on.

It is not possible to switch the daytime lights on or off. Please contact a specialised workshop if you wish to deactivate the lights.

Daytime lights (bi-xenon lamps)

The daytime lights increase road safety in vehicles fitted with bi-xenon lamps. The lights are built-in separately to the headlights and are switched on each time the ignition is turned on if the light setting is in position **0** or **AUTO**.

Automatic control of the dipped beam in combination with the daytime lights (bi-xenon headlights)

If the *dipped light control* and the *daytime lighting* are activated at the same time, the dipped lights and the instrument panel lighting will automatically come on as required (e.g. on entering a tunnel) and the daytime lights will go off. When the automatic dipped light control switches off the

dipped lights (e.g. on coming out of the tunnel), the daytime lights come back on.

Activating the daytime driving lights

With the ignition switched off, move the turn signal and main beam lever upwards and back (right turn signal and headlight flash).

Switch on the ignition for 3 seconds while holding this position. The daytime lights are activated and can be switched on.

Switching off daytime driving lights

With the ignition switched off, move the turn signal and main beam lever upwards and back (left turn signal and headlight flash) and hold in this position.

Switch on the ignition for 3 seconds while holding this position. The daytime lights are deactivated and cannot be switched on.

Activating daytime lights (bi-xenon lamps)

Remove the key from the ignition, move the turn signal lever upwards (right turn signal) and press it backwards to flash position and hold it in this position.

Insert the key and switch the ignition on, holding it in this position for 3 seconds. Then, switch off the ignition. The daytime lights are activated and can be switched on.

Deactivating daytime lights (bi-xenon lamps)

Remove the key from the ignition, move the turn signal lever upwards (left turn signal) and press it backwards to flash position and hold it in this position.

Insert the key and switch the ignition on, holding it in this position for 3 seconds. Then, switch off the ignition. The daytime lights are deactivated and cannot be switched on. ▶

¹⁾ It is only available in some countries or as an optional extra

**Note**

Please observe any relevant legal requirements which may apply in your country.

Coming home/leaving home function*

The Coming Home function is controlled manually. The Leaving Home function is controlled with a photosensor.

If the Coming Home or Leaving Home function is connected, the front side and dipped lights, the tail lights and the number plate light will light up to provide assistance.

Coming home function

The Coming Home function is activated by switching off the ignition and briefly flashing the lights. When the driver door is opened, the Coming Home lighting comes on. If the driver door is already open when the lights are flashed briefly, the Coming Home lighting comes on **immediately**.

When the last door of the vehicle or the rear lid is closed, the Coming Home function starts and the switching off the headlights is delayed.

The Coming Home lighting switches off in the following cases:

- On completion of the time period established for the delay in switching off the lights after all the vehicle doors and the rear lid have been closed.
- If, 30 seconds after being connected, any doors or the rear lid remain open.
- If the light switch is turned to position **0**.
- If the ignition is switched on.

Leaving home function

The Leaving Home function is activated when the vehicle is unlocked if:

- the light control is in position **AUTO** and
- the photosensor detects “darkness”.

■ The Leaving Home lighting switches off in the following cases:

- If the time period for the delay in switching off the headlights has ended
- If the vehicle is locked again.
- If the light switch is turned to position **0**.
- If the ignition is switched on.

**Note**

The setting for the delay in switching off the headlights in the Coming Home and Leaving Home function can be changed or the function can be connected or disconnected in the menu **Lights and visibility** ⇒ page 75.

- If the ignition key is removed while the lights are on, and the lights are flashed briefly and the driver door opened, **no** audible warning is heard, as when the Coming Home function is on, the lights are automatically switched off after a period of time (except when the light switch is in position **⊘** or **⊘D**).

Instrument and switch lighting / Headlight range control

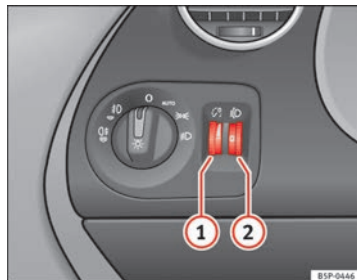

Fig. 74 Dash panel: regulation for instrument and switch lighting and headlight range control

Instrument and switch lighting ①

When the headlights are switched on, the brightness of the instruments and switch lighting can be regulated to suit your requirements by turning the thumb wheel ⇒ Fig. 74 ①.

The instrument lighting (dials and needles), the centre console illumination and the illumination of the displays are regulated by a photodiode incorporated in the instrument panel.

The instrument lighting (dials and needles) is switched on when the ignition is on and the **vehicle lights are off**. The instrument lighting is dimmed automatically as the daylight starts to fade. It goes out completely when the ambient light level is very low. This function is intended to remind the driver to switch on the dipped beam headlights in good time when light conditions become poor.

Headlight range control ②

By using the electrical headlight range control, ② you can adjust the headlight range to the load level that is being carried in the vehicle. This way, it is possible to avoid dazzling oncoming traffic more than necessary. At the

same time, by using the correct headlight settings, the driver has the best possible lighting for the road ahead.

The headlights can only be adjusted when the dipped beam is switched on. To lower the beam, turn the thumb wheel down ② from the basic setting 0.

Dynamic headlight range control

Vehicles with **gas discharge lamps** (“xenon lamps”) are equipped with **dynamic headlight range control**. This means that the headlights will be adjusted to suit the load level of the vehicle and “nodding movements” when pulling off and braking are automatically compensated for.

Vehicles with gas discharge bulbs do not have headlight range control. ■

Adaptive headlights* (for driving round bends)

When driving around bends, the headlights will light the most important areas of the road.

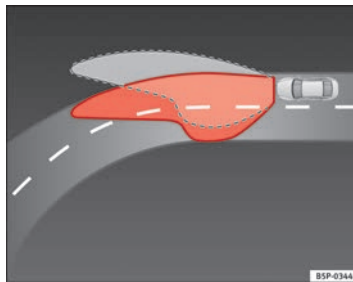



Fig. 75 Cornering lighting using adaptive headlights ▶

Dynamic cornering lights* (AFS)

The **dynamic cornering lights** only operate if the vehicle is travelling at more than 10 km/h (6 mph) and the dipped headlights are on. When taking a bend, the road is illuminated better with directional gas discharge bulbs than with conventional fixed headlights.

A fault in the system is indicated via the flashing of the control lamp  on the instrument panel. At the same time, a text message with information or instructions to perform necessary operations may appear on the instrument panel display. Take the vehicle to a specialised workshop and have the fault repaired.

If the control lamp  lights up on the instrument panel but all the bulbs are operating correctly \Rightarrow page 272, there may still be a fault in the dynamic curve lighting system (AFS). Take the vehicle to a specialised workshop and have the fault repaired.

WARNING

If the “automatic dipped beam control” is switched on, the dipped beam headlights will not be switched on in fog. They should be switched on manually using the light switch. The driver is personally responsible for the correct use of lights in all situations. “Automatic headlight control” is merely a system to support the driver. Where necessary, switch on the lights manually using the light switch.

Fog lights with cornering function*

When the turn signal is switched on to turn or on very tight bends, the right or left fog light automatically comes on to function as a **cornering light**. The cornering light only operates if the dipped beam lights are on.

WARNING

If the “automatic dipped beam control” is switched on, the dipped beam headlights will not be switched on in fog. They should be switched on manually using the light switch. The driver is personally responsible for the correct use of lights in all situations. “Automatic headlight control” is merely a system to support the driver. Where necessary, switch on the lights manually using the light switch.

Hazard warning lights

The hazard warning lights are used to draw the attention of other road users to your vehicle in emergencies.



Fig. 76 Dash panel: switch for hazard warning lights



If your vehicle breaks down:

1. Park your vehicle at a safe distance from moving traffic.
2. Press the button to switch on the hazard warning lights \Rightarrow  \blacktriangleright

3. Switch the engine off.
4. Apply the handbrake.
5. On a manual gearbox engage 1st gear. On an automatic gearbox, move the selector lever to **P**.
6. Use the warning triangle to draw the attention of other road users to your vehicle.
7. Always take the vehicle key with you when you leave the vehicle.

Switch on the hazard warning lights to warn other road users, for example:

- reaching the tail end of a traffic jam,
- there is an emergency
- your vehicle breaks down due to a technical fault,
- you are towing another vehicle or your vehicle is being towed.

All turn signals flash simultaneously when the hazard warning lights are switched on. The two turn signal turn signal lamps  and the turn signal lamp in the switch  will flash at the same time. The hazard warning lights also work when the ignition is switched off.

Emergency braking warning

If the vehicle is braked suddenly and continuously at a speed of more than 80 km/h (50 mph), the brake light flashes several times per second to warn vehicles driving behind. If you continue braking, the hazard warning lights will come on automatically when the vehicle comes to a standstill. They switch off automatically when the vehicle starts to move again.



WARNING

- The risk of an accident increases if your vehicle breaks down. Always use the hazard warning lights and a warning triangle to draw the attention of other road users to your stationary vehicle.
- Never park where the catalytic converter could come into contact with inflammable materials under the vehicle, for example dry grass or spilt petrol. This could start a fire!



Note

- The battery will run down if the hazard warning lights are left on for a long time, even if the ignition is switched off.
- The use of the hazard warning lights described here is subject to the relevant statutory requirements. ■

Turn signal and main beam headlight lever

The turn signal and main beam lever also operates the parking lights and the headlight flasher.

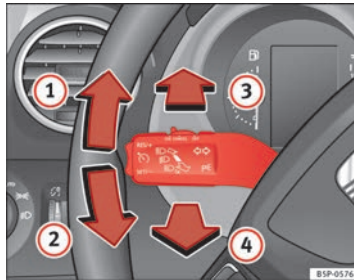

Fig. 77 Turn signal and main beam headlight lever

The turn signal and main beam headlight lever has the following functions:

Switching on the turn signals

- Move the lever all the way up ⇒ Fig. 77 ① to indicate **right**, and all the way down ② to indicate **left**.

Signalling a lane change

- Push the lever up ① or down ② to the point where you incur resistance and then release it. The turn signal will flash several times. The corresponding control lamp will also flash.

Switching main beam on and off

- If the dipped lights are on, push the lever forward ⇒ Fig. 77 ③ to switch on the main beam.
- Push the lever towards the steering wheel ⇒ Fig. 77 ④ to switch off the main beam.

Headlight flashers

- Pull the lever towards the steering wheel ④ to operate the flasher.





Switching on parking lights

- Switch the ignition off and remove the key from the lock.
- Move the turn signal lever up or down to turn the right or left-hand parking lights on, respectively.

WARNING

The main beam can dazzle other drivers. Risk of accident! Never use the main beam headlights or the headlight flasher if they could dazzle other drivers.

Note

- The *turn signals* only work when the ignition is switched on. The corresponding warning lamp  or  flashes in the instrument panel. The control lamp  flashes when the turn signals are operated, provided a trailer is correctly attached and connected to the vehicle. If a turn signal bulb is defective, the control lamp flashes at double speed. If the trailer turn signal bulbs are damaged, control lamp  does not light up. Change the bulb.
- The *main beam headlights* can only be switched on if the dipped beam headlights are already on. The warning lamp  then comes on in the instrument panel. ▶

- The *headlight flasher* comes on for as long as you pull the lever – even if no other lights are switched on. The warning lamp  then comes on in the instrument panel.
- When the *parking lights* are switched on, the headlight and the tail light on the corresponding side of the vehicle light up. The parking lights will only work if the key is removed from the ignition. If the lights are switched on, an **audible warning** will be emitted while the driver door is open.
- If the turn signal lever is left on after the key has been taken out of the ignition lock, an acoustic signal sounds when the driver door is opened. This is a reminder to switch off the turn signal, unless of course you wish to leave the parking light on.

Interior lights

Interior front light, type 1

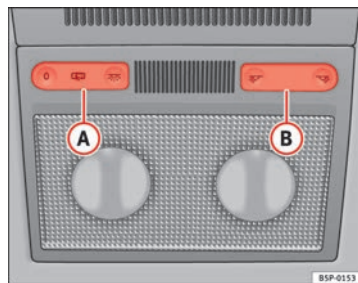

Fig. 78 Interior roof trim:
front interior lighting

The switch \Rightarrow Fig. 78 **A** is used to select the following positions:

Courtesy light position

Rocker switch in flat position (not activated). The interior lighting is automatically switched on when the vehicle is unlocked or the key removed from the ignition. And turn off approx. 20 seconds after closing the doors. The interior lights are switched off when the vehicle is locked or when the ignition is switched on.

Interior light switched on

Push the switch to the position .

Interior light switched off **O**

Push the switch to position **O** \Rightarrow Fig. 78.



Note

If not all the vehicle doors are closed, the interior lights will be switched off after approx. 10 minutes, providing the ignition key has been removed and the courtesy light position selected. This prevents the battery from discharging.

Interior front light, type 2

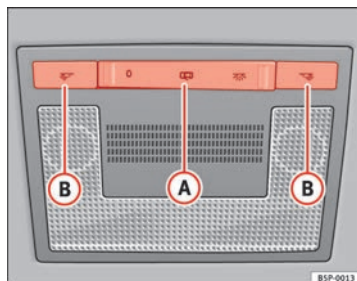

Fig. 79 Interior roof trim:
front interior lighting

The switch ⇒ Fig. 79 (A) is used to select the following positions:

Courtesy light position ☐

Rocker switch in flat position (not activated). The interior lighting is automatically switched on when the vehicle is unlocked or the key removed from the ignition. And turn off approx. 20 seconds after closing the doors. The interior lights are switched off when the vehicle is locked or when the ignition is switched on.

Interior light switched on ☒

Push the switch to the position ☒.

Interior light switched off 0

Push the switch to position 0 ⇒ Fig. 79.

Note

If not all the vehicle doors are closed, the interior lights will be switched off after approx. 10 minutes, providing the ignition key has been removed and the courtesy light position selected. This prevents the battery from discharging.

Front reading lights

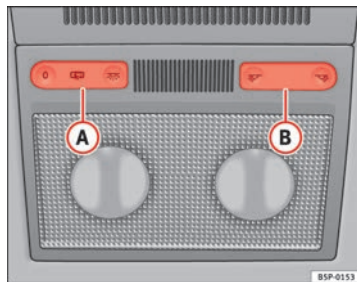

Fig. 80 Interior roof trim: front reading lights, type 1

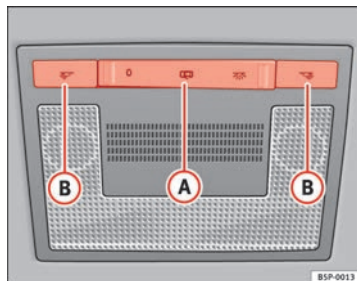

Fig. 81 Interior roof trim: front reading lights, type 2

Switching on the reading light

Press the corresponding button \Rightarrow Fig. 80 (B) and \Rightarrow Fig. 81 (B) to switch on the reading light.

Switching the reading lights off

Press the corresponding button to switch the reading light off. ■

Rear interior lights and reading lights*

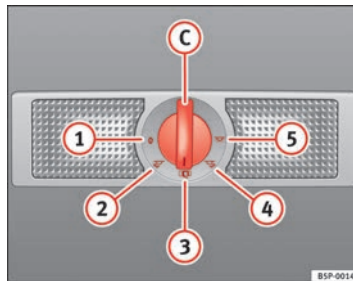

Fig. 82 Interior roof trim: rear interior lights and reading lights.

The switch \Rightarrow Fig. 82 (C) is used to select the following positions:

Interior light switched off 0

In switch position \Rightarrow Fig. 82 (1), the interior and reading lights are switched off.

Switching on the reading light

Turn the switch to position (2) (left reading light) or to position (4) (right reading light).

Courtesy light position

Turn the control to position (3). The interior lighting is automatically switched on when the vehicle is unlocked or the key removed from the ignition. The light turns off about 20 seconds after closing the doors. The interior ►

lights are switched off when the vehicle is locked or when the ignition is switched on.

Interior lights or both reading lights switched on

Turn the control to position .



Note

If not all the vehicle doors are closed, the interior lights will be switched off after approx. 10 minutes, providing the ignition key has been removed and the courtesy light position selected. This prevents the battery from discharging.

The sun visors for the driver and the front passenger can be pulled out of their mountings in the centre of the vehicle and turned towards the doors => Fig. 83 

The vanity mirrors in the sun visors have covers. When you open the cover , a lamp in the roof lights up.

The light* in the roof lining will go out when the vanity mirror cover is pushed back or the sun visor is pushed back up.



Note

The roof lamp will turn off about 10 minutes following the removal of the ignition key. This prevents the battery from discharging.

Visibility

Sun visors

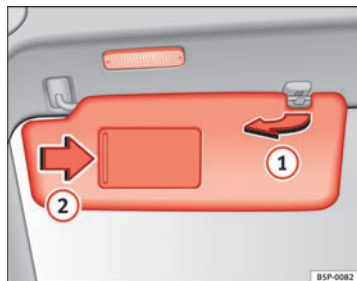

Fig. 83 Sun visor on the driver side

Windscreen wipers

Front windscreen wipers

The windscreen wiper lever controls the windscreen wipers and the automatic wash and wipe.

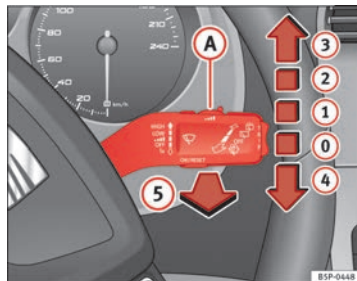

Fig. 84 Windscreen wiper and windscreen wash lever

The windscreen wiper lever ⇒ Fig. 84 has the following positions:

Switching off the windscreen wipers

- Move the lever to position 0.

Interval wipe

- Move the lever up to position 1.
- Move the control A to the left or right to set the length of the wipe intervals. Control to the left: long intervals; control to the right: short intervals. Four wiper interval stages can be set using switch A.

Slow wipe

- Move the lever up to position 2.

Continuous wipe

- Move the lever up to position 3.

Short wipe

- Move the lever down to position 4 to give the windscreen a short wipe. The wiper will start to move faster if you keep the lever pressed down for longer than two seconds.

Wash and wipe automatic system

- Pull the lever towards the steering wheel - Position 5. The wash function will start immediately and the wipers will start with a slight delay. The wash and wiper systems will function at the same time at speeds of over 120 km/h (75 mph).
- Release the lever. The wipers will keep running for approximately four seconds.

Heated windscreen in the wiper blade area*

In some countries and with some versions, there is the possibility of heating the windscreen in the area of the windscreen wiper blades in order to aid de-icing in the zone. The function is switched on by pressing the heated rear window key.

**WARNING**

- Worn and dirty wiper blades reduce visibility and safety levels while driving.
- In cold conditions, you should not use the wash/wipe system unless you have warmed the windscreen with the heating and ventilation system. The windscreen washer fluid could otherwise freeze on the windscreen and obscure your view of the road.
- Always note the corresponding warnings on ⇒ page 243.

**CAUTION**

In icy conditions, always check that the wiper blades are not frozen to the glass before using the wipers for the first time. If you switch on the windscreen wipers when the wiper blades are frozen to the windscreen, you could damage both the wiper blades and the wiper motor.

**Note**

- The windscreen wipers will only work when the ignition is switched on.
- In certain versions of vehicles with alarms, the windscreen wiper will only work when the ignition is on and the bonnet closed.
- When in use, the wipers do not go as far as the rest position. When the lever is moved to position 0, they are totally hidden.
- The next speed down will automatically be selected if wiper speed ② ⇒ Fig. 84 or ③ is selected when the vehicle stops. The set speed will be resumed when the vehicle starts again
- The windscreen will be wiped again after approximately five seconds once the “automatic wipe/wash system” has been operated, provided the vehicle is in transit (drip function). If you activate the wipers less than three seconds after the drip function, a new wash sequence will begin without the last wipe. For the “drip” function to work again, you have to turn the ignition off and then on again.

- When the “interval wipe function” is on, the intervals are directly proportional to the speed. This way, the higher the vehicle speed the shorter the intervals.
- The wiper will try to wipe away any obstacles that are on the windscreen. The wiper will stop moving if the obstacle blocks its path. Remove the obstacle and switch the wiper back on again.
- Before removing any objects that may be trapped in the side areas of the windscreen, always move the wiper arms to the service position (horizontal).
- The heat output of the heated jets is controlled automatically when the ignition is switched on, depending upon the outside temperature. ■

Rain sensor*

The rain sensor controls the frequency of the windscreen wiper intervals, depending on the amount of rain.

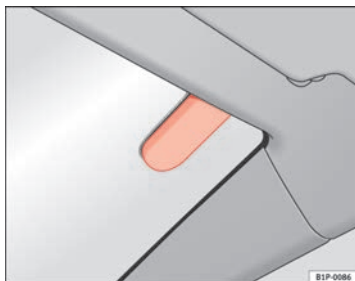

Fig. 85 Rain sensor*



Fig. 86 Windscreen wiper lever

Switching on the rain sensor

- Move the windscreen wiper lever into position ① ⇒ Fig. 86.
- Move the control A to the left or right to set the sensitivity of the rain sensor. Control to the right: highly sensitive. Control to the left: less sensitive.

The rain sensor is part of the interval wipe function. You will have to switch the rain sensor back on if you switch off the ignition. This is done by switching the wiper interval wipe function off and back on.



Note

- Do not put stickers on the windscreen in front of the rain sensor. This may cause sensor disruption or faults.

Rear window wiper

The windscreen wiper lever operates the windscreen wiper and the wash and wipe system for the rear window.



Fig. 87 Windscreen wiper and windscreen wash lever: rear window wiper

Switching on the interval wipe

- Press the lever forwards to position **6** ⇒ Fig. 87. The wiper will wipe the window approximately every 6 seconds.

Switching off the interval wipe function

- Pull the lever back from position **6** towards the steering wheel. The wiper will continue to function for a short period if you switch off whilst the wipers are in motion.

Switching on the windscreen wiper and washer system

- Press the lever fully forwards to position **7** ⇒ Fig. 87. The wash function will start immediately and the wiper will start with a slight delay. The windscreen wash system will function as long as you hold the lever in this position.

- Release the lever. The wiper then wipes for approximately 4 seconds, and then in intervals again.
- Release the lever. The washer system stops and the wipers function.

WARNING

- A worn or dirty wiper blade will obstruct visibility and reduce safety.
- Always note the corresponding warnings on ⇒ page 243.

CAUTION

In icy conditions, always check that the wiper blade is not frozen to the glass before using the wiper for the first time. If you switch on the wiper when the wiper blade is frozen to the glass, this could damage both the wiper blade and the wiper motor.

Note

- The windscreen wiper will only function when the ignition is switched on and the rear lid is closed.
- In reverse gear, with the windscreen wipers switched on, the rear windscreen wiper will make one wipe. ■

Headlight washer*

The headlight washers clean the headlight lenses.

The headlight washers are activated automatically when the windscreen washer is used and the windscreen wiper lever is pulled towards the steering wheel for at least 1.5 seconds – provided the dipped beam headlights or main beams are switched on. Clean off stubborn dirt (insects, etc.) from the headlights at regular intervals, for instance when filling the fuel tank. ▶

**Note**

- To ensure that the headlight washers work properly in winter, keep the nozzle holders in the bumper free of snow and remove any ice with a de-icer spray.
- To remove water, the windscreen wipers will be activated from time to time, the headlight washers will be activated every three cycles.

Rear vision mirrors

Interior rear vision mirror

It is dangerous to drive if you cannot see clearly through the rear window.

Manual anti-dazzle function for interior rear vision mirror

In the basic mirror position, the lever at the bottom edge of the rear vision mirror should be at the front. Pull the lever to the back to select the anti-dazzle function.

Automatic anti-dazzle interior rear vision mirror*

The automatic anti-dazzle function can be switched on and off as desired.

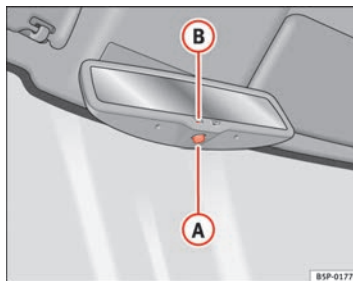

Fig. 88 Automatic anti-dazzle interior rear vision mirror.

Switching off the anti-dazzle function

- Press button **A** ⇒ Fig. 88. Control lamp **B** goes off.

Switching on the anti-dazzle function

- Press button **A** ⇒ Fig. 88. Control lamp is lit.

Anti-dazzle function

The anti-dazzle function is activated every time the ignition is switched on. The green warning lamp lights up in the rear vision mirror housing.

When the anti-dazzle function is enabled, the interior rear vision mirror will darken **automatically** according to the amount of light it receives. The anti-dazzle function is cancelled if reverse gear is engaged. ▶

Note

- The automatic anti-dazzle function will only work properly if the sun blind* for the rear window is retracted and there are no other objects preventing light from reaching the interior rear vision mirror.
- If you have to stick any type of sticker on the windscreen, do not do so in front of the sensors. Doing so could prevent the anti-dazzle function from working well or even from working at all.

Exterior mirrors

The exterior mirrors can be adjusted using the rotary knob in the centre console.

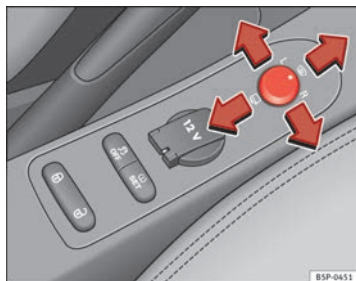



Fig. 89 Controls of exterior mirrors

Basic setting of exterior mirrors

1. Turn knob ⇒ Fig. 89 to position **L (left exterior mirror)**.
2. Turn the rotary knob to position the exterior mirror so that you have a good view to the rear of the vehicle.

3. Turn knob to position **R (right exterior mirror)**.
4. Swivel the rotary knob to position the exterior mirror so that you have a good view to the rear of the vehicle ⇒ .

Heating the exterior mirrors*

- Turn the knob forwards to the central position  so that the heated rear view mirrors warm up and the heated windscreen* in the wiper blade rest area is activated ⇒ page 128.
- The exterior mirror heating is not activated in temperatures above approximately 20 °C.

Folding in exterior mirrors*

- Turn the control ⇒ Fig. 89 to position  to fold in the exterior mirrors. You should always fold in the exterior mirrors if you are driving through an automatic car wash. This will help prevent damage.

Folding exterior mirrors with convenience closing*

- The exterior mirror will fold back automatically with convenience closing (with the remote or the key)
- To unfold it again, open the door and use the contact

Folding exterior mirrors back out to the extended position*

- Turn the knob to another position to fold the exterior mirrors back out ⇒ .

Synchronised mirror adjustment

1. Turn the control to the position **L (left exterior mirror)**.

2. Turn the rotary knob to position the exterior mirror so that you have a good view to the rear of the vehicle. The **right exterior mirror** will be adjusted at the same time (synchronised).

**WARNING**

- Convex or aspheric mirrors increase the field of vision however the objects appear smaller and further away in the mirrors. If you use these mirrors to estimate the distance to vehicles behind you when changing lane, you could make a mistake. Risk of accident.
- If possible, use the rear vision mirror to estimate distances to vehicles behind you.
- Make sure that you do not get your finger trapped between the mirror and the mirror base when folding back the mirrors. Risk of injury!

**For the sake of the environment**

The exterior mirror heating should be switched off when it is no longer needed. Otherwise, it is an unnecessary fuel waste.

**Note**

- If the electrical adjustment ever fails to operate, the mirrors can be adjusted by hand by lightly pressing the edge of the mirror glass.
- In vehicles with electric exterior mirrors, the following points should be observed: if, due to an external force (e.g. a knock while manoeuvring), the adjustment of the mirror housing is altered, the mirror will have to be completely folded **electrically**. Do not readjust the rear vision mirror housing by hand, as this will interfere with the mirror adjuster function.
- The rear vision mirrors can be adjusted separately or simultaneously, as described before.
- The fold-in function on the exterior mirrors is not activated at speeds of above 40 km/h (25 mph). ■

Seats and storage

The importance of correct seat adjustment

Proper seat adjustment optimises the level of protection offered by seat belts and airbags.

Your vehicle has **five** seats, two in the front and three in the rear. Each seat is equipped with a three-point seat belt.

The driver seat and the front passenger seat can be adjusted in many ways to suit the physical requirements of the vehicle occupants. The correct seat position is very important for:

- a fast and easy operation of all controls on the instrument panel,
- a relaxed posture which does not cause drowsiness,
- a safe driving ⇒ page 7,
- ensuring that the seat belts and airbag system provide maximum protection ⇒ page 19.

WARNING

- If the driver and passengers assume improper sitting positions, they may sustain critical injuries.
- Never transport more than the permitted amount of people in your vehicle.
- Every vehicle occupant must properly fasten and wear the seat belt belonging to his or her seat. Children must be protected with an appropriate child restraint system ⇒ page 46, Child safety.
- The front seats and all head restraints must always be adjusted to body size and the seat belt must always be properly adjusted to provide you and your passengers with optimum protection.

WARNING (Continued)

- Always keep your feet on the footwell when the vehicle is moving; never rest them on the dash panel, out of the window or on the seat. This is also applied to passengers. An incorrect sitting position exposes you to an increased risk of injury in case of a sudden braking or an accident. If the airbag is triggered, you could sustain severe injuries due to an incorrect sitting position.
- It is important for the driver and front passenger to keep a distance of at least 25 cm from the steering wheel and dash panel. Failure to respect the minimum distance means that the airbag will not protect you. Risk of fatal injury. The distance between the driver and the steering wheel or between the front passenger and the dash panel should always be as great as possible.
- Adjust the driver or front passenger seat only when the vehicle is stationary. This also applies to the forwards/backwards adjustment of the rear seats. Otherwise, your seat could move unexpectedly while the vehicle is moving. This could increase the risk of an accident and therefore, injury. In addition, while adjusting your seat, you will assume an incorrect sitting position. Risk of fatal accidents.
- Special guidelines apply to installing a child seat on the front passenger seat. When installing a child seat, please observe the warnings described in ⇒ page 46, Child safety.

Head restraints

Correct adjustment of head restraints

Properly adjusted head restraints are an important part of passenger protection and can reduce the risk of injuries in most accident situations.

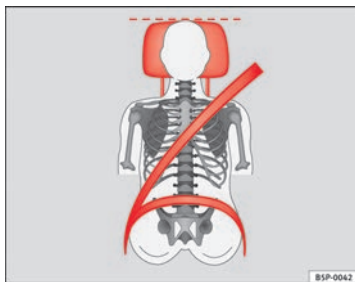

Fig. 90 Front view: head restraints and seat belts correctly adjusted

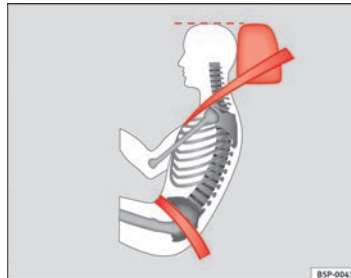

Fig. 91 Side view: head restraints and seat belts correctly adjusted

- Adjust the head restraint so that the top is at the same level as the top of your head or as close as possible to the same level as the top of your head, at least at eye level ⇒ Fig. 90 and ⇒ Fig. 91.

Adjusting the head restraints ⇒ page 137



WARNING

- Travelling with the head restraints removed or improperly adjusted increases the risk of severe injuries.
- Improperly adjusted head restraints could lead to death in the event of a collision or accident.
- Incorrectly adjusted head restraints also increase the risk of injury during sudden or unexpected driving or braking manoeuvres.
- The head restraints must always be adjusted according to the height of the passenger.

Removing or adjusting head restraints

The head restraints can be adjusted by moving them up and down.

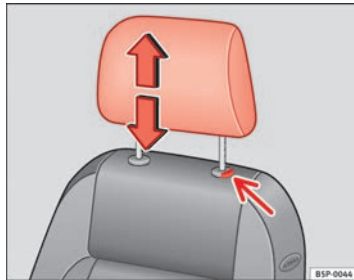

Fig. 92 Adjusting and removing the head restraints

Adjusting height (front seats)

- Press the button on the side and pull upwards to the desired position.
- To lower the head restraint, press the button and push head restraint downwards.
- Make sure that it engages securely into position.

Adjusting height (rear seats)

- Press the button on the side and pull upwards to the desired position.
- To lower the head restraint, press the button and push head restraint downwards.

- Make sure that the head restraint engages securely in one of its positions. ⇒ page 14

Angle adjustment (front seats)

- Press the head restraint forward or back to the required position.

Removing the head restraint

- Push the head restraint up as far as it will go.
- Press the button ⇒ Fig. 92 (arrow).
- Pull head restraint out of fitting without releasing the button.

Fitting the head restraint

- Insert the head restraint into the guides on the backrest.
- Push head restraint down.
- Adjust the head restraint to suit body size ⇒ page 14 and ⇒ page 13.

WARNING

- Never drive if the head restraints have been removed. Risk of injury.
- Never drive if the head restraints are in an unsuitable position, there is a risk of serious injury.
- After refitting the head restraint, you must always adjust it properly for height to achieve optimal protection.
- Please observe the safety warnings in ⇒ page 136, Correct adjustment of head restraints.

Front seats

Adjustment of the front seats



Fig. 93 Front left seat controls

The control elements in ⇒ Fig. 93 are mirrored for the front right-hand seat.

① Adjusting the seat forwards and backwards

- Pull up the grip and move the seat forwards or backwards.
- Then release the grip ① and move the seat further until the catch engages.

② Adjusting the seat height*

- Pull the lever up or push down (several times if necessary) from its home position. This adjusts the seat height in stages.

③ Adjusting the backrest angle

- Take your weight off the backrest and turn the hand wheel.

④ Adjusting the lumbar support*

- Take your weight off the backrest and turn the hand wheel to adjust the lumbar support.

As you make the adjustments, the curvature of the cushioned area of the lumbar region becomes more or less acute. In this way, it adapts to the natural curvature of the spine.

WARNING

- Never adjust the driver or front passenger seat while the vehicle is in motion. While adjusting your seat, you will assume an incorrect sitting position. Risk of fatal accidents. Adjust the driver or front passenger seat only when the vehicle is stationary.
- To reduce the risk of injury to the driver and front passenger in case of a sudden braking or an accident, never drive with the backrest tilted towards the rear. The maximum protection of the seat belt can be achieved only when the backrests are in an upright position and the driver and front passenger have properly adjusted their seat belts. The further the backrests are tilted to the rear, the greater the risk of injury due to improper positioning of the belt web!
- Exercise caution when securing the seat height into forwards/backwards position. Injuries can be caused if the seat height is adjusted without due care and attention.

Heated seats*

The front seat cushions and backrests can be heated electrically.



Fig. 94 Thumb wheel for the front seat heating



Fig. 95 Front seat heating with Climatronic

Front seat heating for vehicles without Climatronic

- Turn the appropriate thumb wheel ⇒ Fig. 94 to switch on the seat heating. The seat heating is switched off in the 0 position.

Front seat heating for vehicles with Climatronic

- Press button  to switch on the seat heating.
- Press once to set seat heating at maximum level (level 3).
- Press twice to set seat heating at medium level (level 2).
- Press three times to set seat heating at minimum level (level 1).
- When the button is pressed four times, the heating goes off and the LED goes out (level 0).

The seat heating only works when the ignition is switched on. The left thumb wheel controls the left seat and the right thumb wheel the right seat.



CAUTION

To avoid damaging the heating elements, please do not kneel on the seat or apply sharp pressure at a single point to the seat cushion and backrest. ■

Rear seats

Seat adjustment

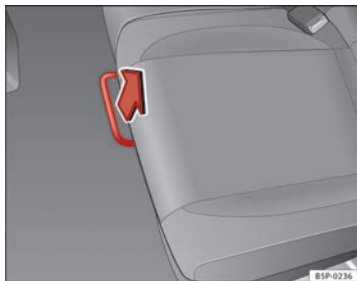

Fig. 96 For unlocking the rear seat

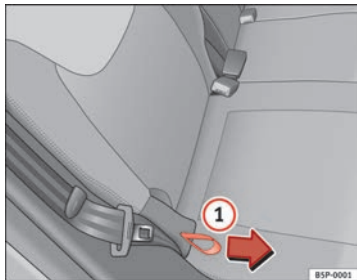

Fig. 97 Rear seat backrest angle adjustment

The seats may be moved forwards or backwards independently. The movement can be 1/3 or 2/3 of the seat. There are various possible positions.

Adjusting reach

- In the seated position, unlock the lever in the direction of the arrow ⇒ Fig. 96.
- Move the seat cushion forwards or backwards to the desired position.

Adjusting the backrest angle

- Hold the backrest at the top. Pull the loop on the side of the seat ⇒ Fig. 97 ① in the direction of the arrow and hold the loop in this position. Push the backrest to the required position and release the loop.



WARNING

- Adjust the seat only when the vehicle is stationary. Otherwise, your seat could move unexpectedly while the vehicle is moving. This could increase the risk of an accident and therefore, injury.
- Do not push the backrests down when the seat is moved, this is to avoid damage to the centre console.
- Ensure that the seat, once moved, is fixed in position.



Note

- In order to maintain the maximum luggage compartment space, put the backrests in position normal, without moving.
- In order to maintain the maximum space without putting the backrests down, move the seats forward to the desired position.

Folding the seat backrests down

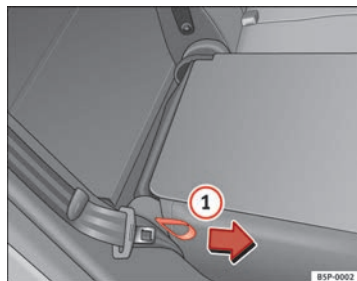

Fig. 98 Folding or opening the rear seat backrests

- Pull the loop on the side of the seat ⇒ Fig. 98 ①

In this position the backrest is locked. This is the reason why the loop located on the side of the seat must be pulled in the direction of the arrow to open the backrest.

WARNING

- You should check that the backrest has engaged properly in position after the loop is released.
- For safety reasons the locking system loops on the seats may not be used to secure any items.

Lifting the seat backrests

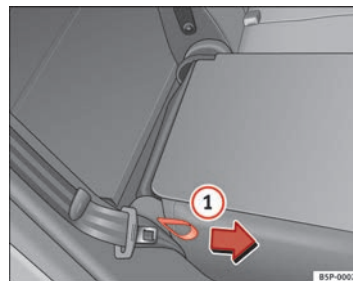

Fig. 99 Folding or opening the rear seat backrest

- Pull the loop on the side of the seat ⇒ Fig. 99 ① in the direction of the arrow and lift the seat backrest into position.

WARNING

- You should check that the backrest has engaged properly in position after the loop is released.
- For safety reasons the locking system loops on the seats may not be used to secure any items.
- After locking the seat backrest into position ensure that the seat belts protrude from the seat.

Storage compartment

Storage compartment on the front passenger side



Fig. 100 Passenger side: storage compartment

The compartment can be opened by pulling the lever ⇒ Fig. 100.

WARNING

Always keep the storage compartment cover closed while the vehicle is in motion in order to reduce the risk of injury caused by a sudden braking or by an accident.

Front centre armrest with storage compartment

There is a storage compartment in the armrest.



Fig. 101 Front armrest with storage compartment

- To open the storage compartment, lift the armrest up in the direction of the arrow ⇒ Fig. 101 and then lift the cover.
- To access the CD changer* or the lower storage compartment, pull on the armrest cover without pressing on the button.
- To close the storage compartment, push the armrest down.

WARNING

Always keep the storage compartment closed while the vehicle is in motion to reduce the risk of injury from the armrest during a sudden braking manoeuvre or in the event of an accident.

Note

The CD changer is located in this compartment.

Storage compartment under the front seats*

There is a storage compartment with a cover under each front seat.



Fig. 102 Storage compartment under the front seats

The drawer* ⇒ Fig. 102 (A) is opened by pushing the button and putting the cover back.

There are two open positions of 15 and 60 degrees depending on the pressure applied to the cover. In the 60 degree position, the cover will collapse if too much pressure is applied.

To close the drawer, press the cover until it locks into position.

WARNING

- The drawers will hold a maximum weight of 1.5 kg.
- Do not drive with the drawer cover open. There is an injury risk for passengers if the cargo is released in case of sudden braking or an accident.

Folding table*

Folding trays are fitted to the rear of the front seat backrests.



Fig. 103 Folding tray on the front left seat

- To open the tray, open it up in the direction of the arrow ⇒ Fig. 103.

WARNING

- The folding trays may not be folded down whilst the vehicle is in motion and anyone is seated on the second row of seats. There is a risk of injury during a sudden braking manoeuvre! The tray must therefore be closed and properly secured whilst the vehicle is in motion.
- Do not put hot drinks in the drink holders. During normal or sudden driving manoeuvres, sudden braking or an accident, the hot drink could be spilled. Danger of scalding.

CAUTION

When driving, do not leave open cans in the cup holders. The drink might be spilt on braking, for example, and could damage the vehicle.

Roof storage compartment*

There are four storage compartments in the roof

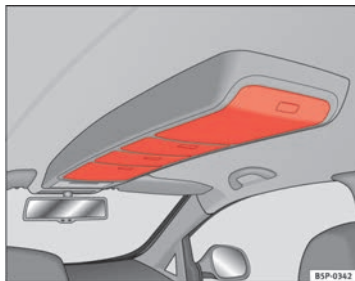

Fig. 104 Roof storage compartments

- Press the button on the cover to open these compartments
⇒ Fig. 104. The cover will then open.
- To close the cover, press it up until it engages.



WARNING

Always keep the storage compartment cover closed while the vehicle is in motion to reduce the risk of injury during a sudden braking manoeuvre or in the event of an accident and to prevent any items from being thrown through the vehicle interior.

Storage in the luggage compartment*

There is a variable storage compartment* in the luggage compartment floor.

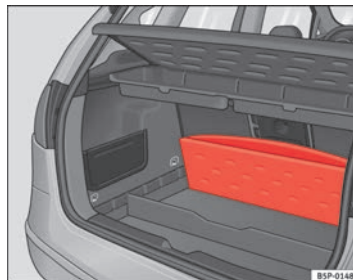

Fig. 105 Foldable luggage compartment cover

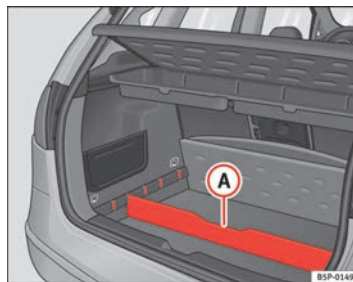

Fig. 106 Luggage compartment divider

- Lift the luggage compartment floor and fold it back all the way ⇒ Fig. 105.
- Fit the separator **(A)** ⇒ Fig. 106, into the side grooves depending on the size of the objects to be transported. The on-board tool kit and the spare wheel are located underneath the luggage compartment.

i Note

- Do not exceed the maximum authorised weight for the vehicle ⇒ page 291.

Luggage compartment net*

There is a storage net in the luggage compartment for securing objects.

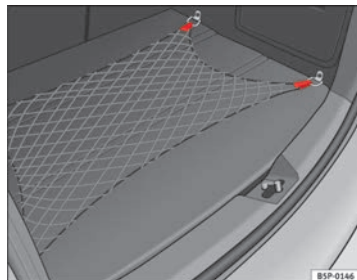

Fig. 107 Luggage compartment net

- Use the fastening rings located on the side of the luggage compartment to attach the storage net ⇒ Fig. 107.

i Note

- Do not exceed the maximum authorised weight for the vehicle ⇒ page 291.

Other storage compartments

Other storage compartments can be found:

- in the centre console,
- in the door trims (front and rear),
- in the side trims of the luggage compartment,
- in the spare wheel recess in the luggage compartment (only on vehicles with an optional anti-puncture kit*).

The clothes hooks are located on the rear roof handles.

! WARNING

- Do not store loose objects on the dash panel. These objects could be flung through the passenger compartment when the vehicle is moving (e.g. while accelerating, braking or cornering) and distract the driver. Risk of accident.
- Ensure that no objects can fall from the centre console or other storage compartments into the driver footwell while the vehicle is moving. In the event of a sudden braking manoeuvre, you will not be able to use the brake, clutch or accelerator. Risk of accident.
- Clothing hung on the coat hooks must not restrict the driver's view. Risk of accident. The coat hooks are intended only for use with light articles of clothing. Do not leave any hard, sharp or heavy objects in hanging articles of clothing. During sudden braking manoeuvres or accidents, especially those involving airbag deployment, these objects could injure the vehicle occupants.

In the centre console, in front of the gear lever, there are two drink holders
⇒ Fig. 108.

! WARNING

- Never place hot drinks in the drink holders. During normal or sudden driving manoeuvres, sudden braking or an accident, the hot drink could be spilled. Danger of scalding.
- Never use rigid materials (for example, glass or ceramic), these could cause injury in the case of an accident.

Front drink holders

Fig. 108 Front drink holders

Rear cup holder*/ Armrest*



Fig. 109 Opening the rear drink holders

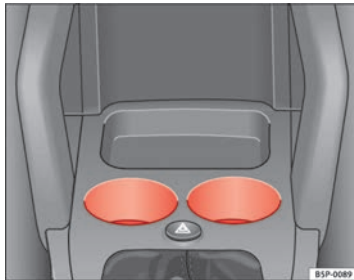

Fig. 110 Rear armrest/ drink holder

Opening and closing the armrest*/ drink holder*

- To open, pull the loop in the direction of the arrow
⇒ Fig. 109 ①.

- To close, lift the Drink holder*/ armrest* in the direction of the arrow ⇒ Fig. 110 ②.

WARNING

Ensure that the load in the luggage compartment is correctly secured with the net* when travelling with the armrest down ⇒ page 145.

Multi-purpose mobile storage compartment* - Installing and removing

This storage compartment may only be placed in the central area of the rear seat

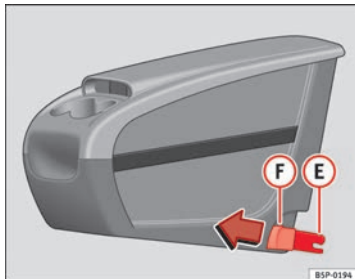

Fig. 111 Mobile storage compartment. Installation

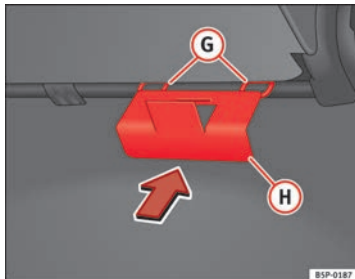

Fig. 112 Mobile storage compartment mounting plate

Fitting mobile storage compartment

- Fold down the small section of the rear seat backrest, in order to access the large section of the backrest.
- Fit the mobile storage compartment mounting plate **(H)** ⇒ Fig. 112 from the inside of the vehicle, through the rear part of the seat. It should be fitted between the backrest and the seat, in the central seat area.
- Push the plate until it clips the cushion frame. The rings of the mobile storage compartment mounting plate appear at the front of the seat.
- If it is difficult to make the plate clip, tilt the rear backrest of the large section forwards slightly and then lean the backrest backwards to make the fitting of the mobile storage compartment onto the mounting plate easier.
- Place the mobile storage compartment onto the foam of the central seat.
- Set both mounting pieces together **(E)** ⇒ Fig. 111, with both mounting rings **(G)** ⇒ Fig. 112 and press hard until both the clips completely connect with the rings.

Removing mobile storage compartment

- Pull each of the buttons ⇒ Fig. 111 **(F)** on the clips (red buttons) forwards, until they snap out of place.
- Fold the larger seat down and remove the mobile storage compartment mounting plate. ■

Multi-purpose mobile storage compartment* - General information

This storage compartment may only be placed in the central area of the rear seat

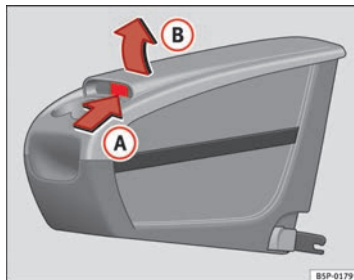

Fig. 113 Mobile storage compartment. Opening

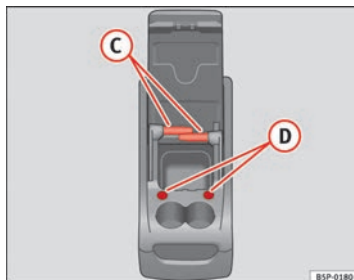

Fig. 114 Mobile storage compartment. Functions

Opening

- Lift the cover (B), in area (A) ⇒ Fig. 113.

Closing

- Push the cover down, until it clips into place.

Uses of the mobile storage compartment

- The front open glove compartment may be used to store small objects that will not damage passengers in the event that the objects are flung around the interior of the vehicle.
- The cup holders are used for holding drink cans or cups.
- The elastic belt on the side may be used for keeping papers and magazines.
- The tables may be used as a support for writing.

To use the table (C) ⇒ Fig. 114, it must be removed from its compartment in the side of the mobile storage compartment and fitted into slot (D) ⇒ Fig. 114 on the front section of the mobile storage compartment.

The table in the right-hand compartment is fitted in the left-hand slot of the front of the mobile storage compartment and the table in the left-hand compartment is fitted in the right-hand slot.

The tables have two positions for use and cannot be interchanged.

WARNING

- The mobile storage compartment supports a maximum load of 5 kg. Do not overload.
- Do not drive when the cover of the mobile storage compartment is open.
- Do not drive when the tables are set up for use.

⚠ WARNING (Continued)

- When the vehicle is moving, keep the tables stored inside the mobile storage compartment with the cover closed, and likewise when they are not in use
- Never place hot drinks in the cup holders. The drink may spill and cause burns when the vehicle is moving.
- Do not leave cans in the cup holders when the vehicle is in motion, there is a danger that the can may be flung around the vehicle and cause injury.
- Make sure that the mounting plate is correctly clipped onto the cushion frame.
- When the plate is not in use, store inside the storage compartment.
- When the mobile storage compartment is not in use, it should always be fastened by the storage net in the luggage compartment.



Note

- Check that the mobile storage compartment is correctly fitted, pulling it forwards by the front glove compartment and checking that both safety clips are correctly clipped onto the rings.

Ashtray*, cigarette lighter* and power sockets

Ashtray*



Fig. 115 Ashtray located in the front drink holder

Opening and closing the ashtray

- To open the ashtray, lift the cover ⇒ Fig. 115.
- To close, push the cover down.

Emptying the ashtray

- Extract the ashtray and empty it.



WARNING

Never put paper in the ashtray. Hot ash could ignite the paper in the ashtray and cause a fire.

Cigarette lighter*



Fig. 116 The cigarette lighter is located in the power socket on the front of the centre console

- Press on the cigarette lighter ⇒ Fig. 116 to activate it ⇒ ⚠.
- Wait for the lighter to spring out.
- Pull out the cigarette lighter and light the cigarette on the glowing coil.

⚠ WARNING

- Improper use of the cigarette lighter can lead to serious injuries or start a fire.
- Using the lighter carefully. Carelessness or negligence when using the cigarette lighter can cause burns and serious injuries.
- The lighter only works when the ignition is turned on or the engine is running. To avoid the risk of fire, never leave children alone inside the vehicle.

Electrical sockets

Electrical equipment can be connected to any of the 12 volt sockets.



Fig. 117 Power socket, centre console, front

Electrical accessories may be connected to the 12 volt power socket in the front centre console ⇒ Fig. 117 and in the luggage compartment*. The appliances connected to each power point must not exceed a power rating of 120 Watt.

⚠ WARNING

The power sockets and the connected accessories will only operate when the ignition is on or when the engine is running. Improper use of the sockets or electrical accessories can lead to serious injuries or cause a fire. To avoid the risk of injury, never leave children alone inside the vehicle.

**Note**

- The use of electrical appliances with the engine switched off will cause a battery discharge.
- Before using any electrical accessories, see the instructions in ⇒ page 224.

Auxiliary audio input (AUX-IN)*



Fig. 118 Auxiliary audio connection

- Lift the AUX cover ⇒ Fig. 118.
- Insert the plug as far as possible (see Radio manual).

AUX RSE connection*



Fig. 119 AUX RSE connection

This connector may be used as an audio input (red and white connectors) or audio and video connector (red, white and yellow connectors). For more details about the use of this audio and video source, see the RSE manual.

MEDIA-IN* connector

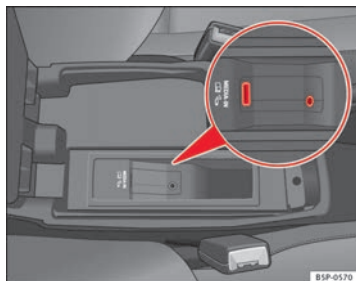

Fig. 120 Connection in central armrest compartment

For information concerning the use of this equipment, please see the Radio handbook. ■

First-aid kit, warning triangle, fire extinguisher

Warning triangle*

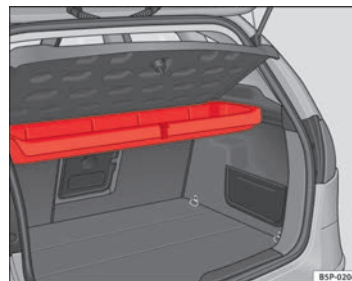

Fig. 121 Warning triangle storage under the rear cover

The warning triangle* is located under the rear shelf in a storage compartment → Fig. 121.



Note

- The warning triangle is not part of the vehicle's standard equipment. ■

First-aid kit and fire extinguisher

The first-aid kit* is located in a storage box on the left side of the luggage compartment. ▶

The fire extinguisher* is attached to the luggage compartment carpet with Velcro.



Note

- The first-aid kit and the fire extinguisher are **not** part of the vehicle's standard equipment.
- The first aid kit must comply with legal requirements.
- Observe the expiry date of the contents of the first aid kit. After it has expired you should purchase a new one.
- The fire extinguisher must comply with legal requirements.
- Ensure that the fire extinguisher is fully functional. The fire extinguisher should, therefore, be checked regularly. The sticker on the fire extinguisher will inform you of the next date for checking.
- Before acquiring accessories and emergency equipment see the instructions in "Accessories and spares" ⇒ page 224. ■

Luggage compartment

Storing objects

All luggage must be securely stowed.

Please observe the following points to ensure the vehicle handles well at all times:

- Distribute the load as evenly as possible.
- Place heavy objects as far forward in the luggage compartment as possible.

- Secure luggage in the luggage compartment with suitable straps on the fastening rings.



WARNING

- **Loose luggage and other loose items in the vehicle can cause serious injuries.**
- **Loose objects in the luggage compartment can suddenly move and change the way the vehicle handles.**
- **During sudden manoeuvres or accidents, loose objects in the passenger compartment can be flung forward, injuring vehicle occupants.**
- **Always store objects in the luggage compartment and secure with suitable straps. This is especially important for heavy objects.**
- **When you transport heavy objects, always take in account that a change in the centre of gravity can also cause changes in vehicle handling.**
- **Please observe information on safe driving ⇒ page 7, Safe driving.**



CAUTION

Hard objects on the shelf could chafe against the wires of the heating element in the rear window and cause damage.



Note

The ventilation slots in front of the rear side windows must not be covered as this would prevent stale air being extracted from the vehicle. ■

Rear shelf

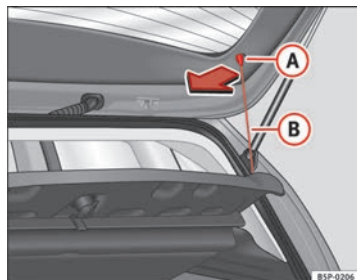

Fig. 122 Rear shelf

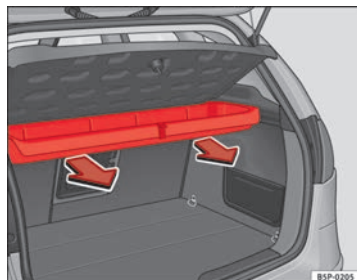

Fig. 123 Removing storage compartment

Removing the shelf

- Unhook the loops ⇒ Fig. 122 B from housings A.

- Extract the shelf from its slot, in its rest position and pull outwards. The storage compartment should remain closed.

To remove the storage compartment

- Pull outwards until the compartment is freed from the pivot point ⇒ Fig. 123.



WARNING

Do not place heavy or hard objects on the rear shelf, because they will endanger the vehicle occupants in case of sudden braking.



CAUTION

- Before closing the rear lid, ensure that the rear shelf is correctly fitted.
- An overloaded luggage compartment could mean that the rear shelf is not correctly seated and it may be bent or damaged.
- If the luggage compartment is overloaded, remove the tray.



Note

- Ensure that, when placing items of clothing on the luggage compartment cover, rear visibility is not reduced.
- If the vehicle is fitted with a storage compartment*, it should only be used to store the emergency triangles* and light objects.

Roof rack*

Please observe the following points if you intend to carry loads on the roof:

- For safety reasons, only luggage racks and accessories supplied by SEAT Official Services should be used.

- It is imperative to precisely follow the fitting instructions included for the rack, taking special care when fitting the front bar in the holes designed for this and the rear bar between the marks on the upper part of the rear door frame while respecting the correct direction of travel indicated in the installation manual. Not following these instructions may damage the bodywork.
- Pay special attention to the tightening torque of the attachment bolts and check them following a short journey. If necessary, retighten the bolts and check them at regular intervals.
- Distribute the load evenly. A maximum load of 40 kg only is permitted for each roof rack system support bar, the load must be distributed evenly along the entire length. However, the maximum load permitted for the entire roof (including the support system) of 75 kg must not be exceeded nor should the total weight of the vehicle be exceeded. See the Technical Data section.
- When transporting heavy or large objects on the roof, any change in the normal vehicle behaviour due to a change in the centre of gravity or an increased wind resistance must be taken into account. For this reason, a suitable speed and driving style must be used.
- For those vehicles fitted with a sliding/tilting sunroof*, ensure that it does not interfere with the load on the roof rack system when opened. ■

Air conditioning

Heating

Operating instructions

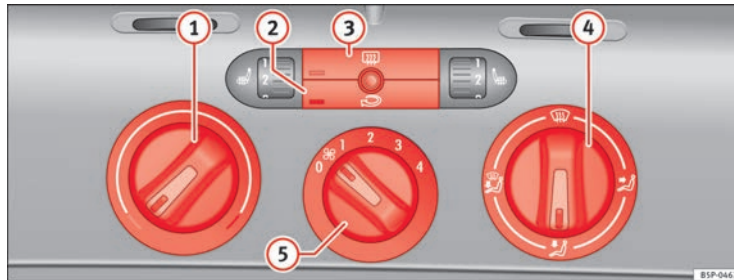

Fig. 124 Heating controls on the dash panel

- Use the knobs ⇒ Fig. 124 ① and ④ and control ⑤ to set the temperature, air distribution and blower speed.
- To switch a function on or off, press the appropriate button ② or ③. When the function is activated, the display window in the lower left of the button is lit.

Temperature

With the regulator ① the heating level is determined. The required temperature inside the vehicle cannot be lower than the ambient temperature. Maximum heat output, which is needed to defrost the windows quickly, is only available when the engine has reached its operating temperature.

Heated rear window

This function ② will be switched off automatically approximately 20 minutes after being switched on. It can also be switched off beforehand by pushing the button

Air recirculation mode

Air recirculation mode ③ prevents strong odours in the outside air from entering the vehicle interior, for example when passing through a tunnel or in queuing traffic ⇒ .

With low outside temperatures, the air recirculation increases the effectiveness of the heating system by heating the air inside the vehicle rather than the air from outside. ▶

Air distribution

Control  for setting the flow of air in the required direction.

 – Air distribution towards the windscreen. If the windscreen air output is on and the air recirculation mode is pressed, this remains active. When the recirculation mode is on, if the air distribution towards the windscreen mode is selected, the recirculation mode is deactivated. For safety reasons, the air recirculation mode should not be connected.

 – Air distribution to the upper body

 – Air distribution to footwell

 – Air distribution to the windscreen and the footwell

Blower

The air flow can be set at four speeds with the control . The air flow should always be set at the lowest speed when driving slowly.



WARNING

- For road safety all windows must be clear of ice, snow, and condensation. This is essential to ensure good visibility. Please familiarise yourself with the correct operation of the heating and ventilation system, including the anti-fog/defrost functions for the windcreens.
- In air recirculation mode, no cold air from the outside enters the vehicle interior. The windows can quickly fog over if the heating is switched off. Therefore, never leave the air recirculation mode switched on for a long time (risk of accident).



Note

Please observe the general notes ⇒ page 167. ■

Climatic*

Controls

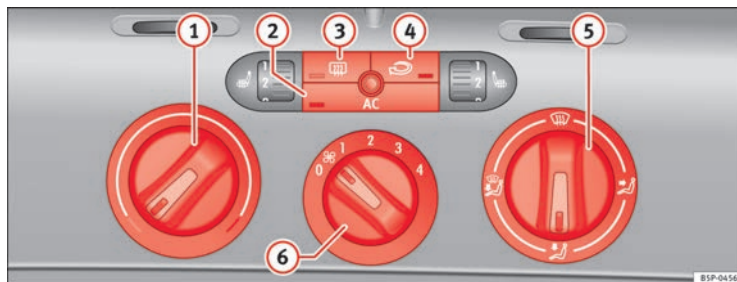

Fig. 125 On the dash panel: Climatic controls

The Climatic or semi-automatic air conditioning system only works when the engine is running and the blower is switched on.

- Use the knobs ⇒ Fig. 125 ① and ⑤ and control ⑥ to set the temperature, air distribution and blower speed.
 - To switch a function on or off, press the appropriate button ②, ③ or ④. When the function is activated, the display window in the lower corner of the button is lit.
- ① Temperature selector ⇒ page 160
 - ② AC button – Heating, ventilation and air-conditioning system on/off ⇒ page 160
 - ③ button – Heated rear window The heating will be switched off automatically approximately 20 minutes after switching on. It can also be switched off beforehand by pushing the button.

- ④ Button – Air recirculation mode ⇒ page 161
- ⑤ Air distribution control ⇒ page 160
- ⑥ Blower switch. There are four speed settings for the air flow. The air flow should always be set at the lowest speed when driving slowly.

WARNING

For road safety all windows must be clear of ice, snow, and condensation. This is essential to ensure good visibility. Please familiarise yourself with the correct operation of the heating and ventilation system, including the anti-fog/defrost functions for the windscreens.

Note

Please observe the general notes ⇒ page 167.

Heating and cooling the interior

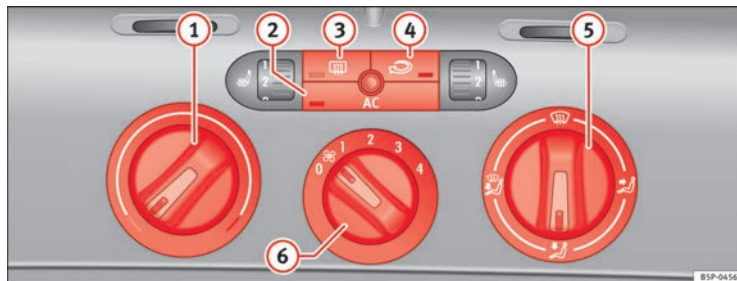

Fig. 126 On the dash panel: Climatic controls

Interior heating

- Turn the temperature selector ⇒ Fig. 126 ① clockwise to select the required temperature.
- Turn the blower switch to one of the settings 1-4.
- Set the air distribution control to the air flow configuration desired: (towards the windscreen), (towards the chest), (towards the footwell) and (towards the windscreen and footwell areas).

Interior cooling

- Switch on the air conditioner using the button ⇒ Fig. 125 .
- Turn the temperature selector anticlockwise until the desired cooling output is reached.
- Turn the blower switch to one of the settings 1-4.

- Use the air distribution regulator to guide the airflow in the required direction (to the windscreen), (to the upper body), (to the footwell) and (to the windscreen and to the footwell).

Heating

Maximum heat output, which is needed to defrost the windows quickly, is only available when the engine has reached its operating temperature.

Air conditioner

When the air conditioning system is switched on, not only the temperature, but also the air humidity in the vehicle interior is reduced. This improves comfort for the vehicle occupants and prevents misting of the windows when the ambient air humidity is high.

If the air conditioning system cannot be switched on this may be caused by the following reasons: ▶

- The engine is not running.
- The blower is switched off.
- The outside temperature is below +3 °C.
- The air conditioning system compressor has been temporarily switched off because the engine coolant temperature is too high.
- The air conditioner fuse is faulty.
- Another fault in the vehicle. Have the air conditioner checked by a specialised workshop.

Air recirculation mode

Air recirculation mode prevents fumes or unpleasant smells from coming from the outside.

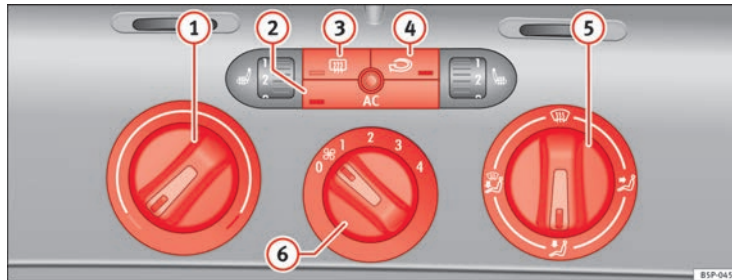



Fig. 127 On the dash panel: Climatic controls

Air recirculation mode \Rightarrow Fig. 127  prevents strong odours in the outside air from entering the vehicle interior, for example when passing through a tunnel or in queuing traffic.

With low temperatures outside, the air recirculation increases the effectiveness of the heating system by warming the air inside the vehicle rather than the cold air from outside.

With high outside temperatures, the air recirculation increases the effectiveness of the air conditioning system by cooling the air inside the vehicle rather than the ambient air.

If the windscreen air output is on and the air recirculation mode is pressed, this remains active. When the recirculation mode is on, if the air distribution towards the windscreen mode is selected, the recirculation mode is deactivated. For safety reasons, the air recirculation mode should not be connected.

! WARNING

In air recirculation mode, no cold air from the outside enters the vehicle interior. If the air conditioning system is switched off, the windows can quickly mist over. Therefore, never leave the air recirculation mode switched on for a long time (risk of accident).

2C-Climatronic*

Controls

The controls allow separate adjustment of air conditioner settings for the left and right.

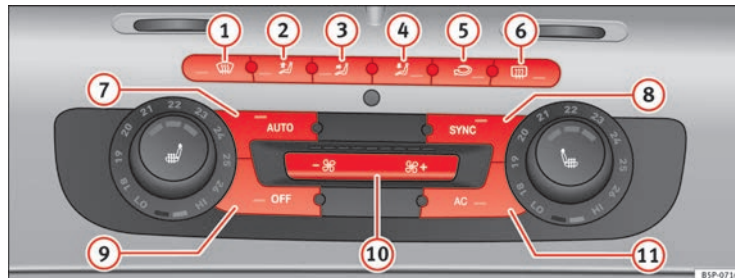











Fig. 128 On the dash panel: 2C Climatronic controls

The air conditioner controls the temperature when the engine is running and the blower is switched on.

- Turn the temperature control knobs ⇒ Fig. 128 to adjust the temperature on the left hand side or the right hand side respectively. ▶

- The functions will be switched on when its buttons are pressed. When these functions are activated, they are indicated on the radio display. In addition, all these functions are lit with LEDs. Press the button again to switch off the function.

The temperature can be adjusted separately for the left and right sides of the vehicle interior.

- 1 Button  – defrost function for the windscreen. The air drawn in from outside the vehicle is directed at the windscreen. The air recirculation mode, if switched on, will be switched off as soon as the defrost function is switched on. At temperatures over 3 °C, the air conditioning system will be switched on automatically in order to dehumidify the air. The button is lit in yellow and the symbol appears on the radio or navigator display.
- 2  button – Upward air distribution
- 3  button – Central air distribution
- 4  button – Downward air distribution
- 5  button – Manual air recirculation mode
- 6  button – Heated rear window The heating will be switched off automatically approximately 20 minutes after switching on. However, it may be turned off by pushing the button. The button lights up yellow and the symbol appears in the display.
- 7  button – Automatic temperature, ventilation and air distribution control ⇒ Booklet Manual de Instrucciones, chapter Automatic mode
- 8  button – Dual zone synchroniser
- 9  button – Switches the 2C Climatronic on and off ⇒ page 165
- 10 Blower control ⇒ page 165
- 11  button – Switches heating, ventilation and air-conditioning system on



WARNING

For road safety all windows must be clear of ice, snow, and condensation. This is essential to ensure good visibility. Please familiarise yourself with the correct operation of the heating and ventilation system, including the anti-fog/defrost functions for the windscreens.



Note

Please observe the general notes ⇒ Booklet Manual de Instrucciones, chapter General notes.

Viewing Climatronic information

Information about the Climatronic system can be displayed on the radio or radio and navigation screen mounted at factory.



Fig. 129 Navigation display with information about the Climatronic

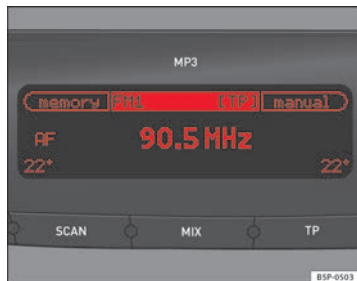

Fig. 130 Radio display with information about Climatronic

The LEDs on the Climatronic controls indicate that the selected function has been activated.

In addition, the radio or radio and navigation displays mounted at factory briefly display the current settings of the Climatronic if any are modified.

The symbols used on the radio or radio and navigation displays are the same as the symbols used for the Climatronic controls. ■

Automatic mode

In automatic mode air temperature, air flow and distribution are automatically regulated so that a specified temperature is attained as quickly as possible and then maintained.

The temperature can be adjusted separately for the left and right sides of the vehicle interior.



Switching on automatic mode

- Press the **AUTO** ⇒ Fig. 128 button. “AUTO High” is shown on the radio display (high fan speed).
- Press the **AUTO** button again ⇒ Fig. 128. “AUTO Low” is shown on the radio display (low fan speed).

Depending upon the version and finish, the vehicle may include:

When a temperature of 22 °C (72 °F) is set in automatic mode a comfortable interior climate is quickly reached. Therefore, we recommend you not to change this adjustment, except as necessary to suit individual preferences or particular circumstances. The inside temperature can be set between +18 °C (64 °F) and +26 °C (80 °F). These are approximate temperatures and the actual temperature may be slightly higher or lower depending on the ambient conditions. ►

Climatronic maintains a constant temperature. The temperature of the air supplied to the interior, the blower speed and the air distribution are regulated automatically. The system also considers the sunlight radiation, so there is no need for manual readjustment. Therefore, **automatic mode** almost always provides the best comfort for the vehicle occupants throughout the year.

Automatic mode is switched off whenever an adjustment is made using the buttons for the air distribution, air flow or  or the air recirculation button . The temperature will continue to be regulated within the parameters manually selected by the user.

Note

There are two automatic modes:

- Automatic mode LO: This calculates the air flow for two people.
- Automatic mode HI: This calculates the air flow for more than two people.

Manual mode

In manual mode you can adjust the air temperature, air flow and distribution as required.

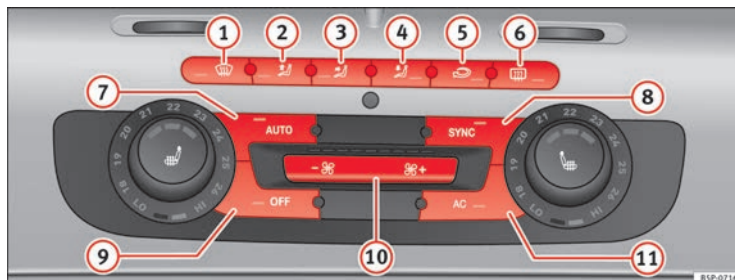

Fig. 131 On the dash panel: 2C Climatronic controls. ►

Switching on manual mode

- To enter manual mode, press one of the buttons ⇒ Fig. 131 ① to ⑤ or press the air flow control ⑩. The selected function is shown on the radio or navigator display.

Temperature

There are separate temperature selectors for the left and right sides of the vehicle interior. The selected temperature is displayed above the selector. The inside temperature can be set between +18 °C (64 °F) and +26 °C (80 °F). These are approximate temperatures and the actual temperature may be slightly higher or lower depending on the ambient conditions.



If a temperature below 18 °C (64 °F) is selected, the display switches to **LO**. In this setting the system runs at maximum cooling output and the temperature is not regulated.

If a temperature above 26 °C (80 °F) is selected, the display switches to **HI**. In this setting the system runs at maximum heating output and the temperature is not regulated.

Blower

The air flow may be adjusted freely using the control ⑩. Always have the blower running at a low setting to ensure a constant flow of fresh air into the vehicle. Pushing the button  to the minimum -1, turns the Climatronic off.

Air distribution

The air distribution is adjusted using the buttons ,  and . It is also possible to open and close some of the air vents separately.

Switching the air conditioning on and off

When the  button is on (LED lit), the air conditioning system is on.

When the  button is off (LED off), the air conditioning system is off.

When the  button is off, the air conditioning system is switched off to save fuel. The temperature continues to self-regulate. The set temperature can then only be reached if it is higher than the outside temperature.

Driver and passenger temperature control

The  button controls the synchronisation of the 2 Climatronic climate zones.



When the  button is off (LED off), the climate zone of the Climatronic is personalised. For example: driver side temperature 22 °C and passenger side temperature 23 °C.

When the  button is on (LED lit), the climate zone of the Climatronic is synchronised. For example: driver side temperature 22 °C and passenger side temperature 22 °C.

If the  button is on and the passenger side temperature is changed, the function is automatically deactivated. ■

Air recirculation mode

Air recirculation mode prevents fumes or unpleasant smells from coming from the outside.

- Press the button  ⇒ Fig. 131 ② to switch air recirculation mode on or off. It is switched on if the following symbol appears in the display .

Air recirculation mode prevents strong odours in the ambient air from entering the vehicle interior, for example when passing through a tunnel or in a traffic jam.

With low outside temperatures, the air recirculation increases the effectiveness of the heating system by heating the air inside the vehicle rather than the air from outside. ►

With high outside temperatures, the air recirculation increases the effectiveness of the air conditioning system by cooling the air inside the vehicle rather than the ambient air.

If the windscreen air output is on and the air recirculation mode is pressed, this remains active. When the recirculation mode is on, if the air distribution towards the windscreen mode is selected, the recirculation mode is deactivated. For safety reasons, the air recirculation mode should not be connected.



WARNING

In air recirculation mode, no cold air from the outside enters the vehicle interior. If the air conditioning system is switched off, the windows can quickly mist over. Therefore, never leave the air recirculation mode switched on for a long time (risk of accident).

General notes

Pollution filter

The pollution filter (a combined particulate filter and active carbon filter) serves as a barrier against impurities in the outside air, including dust and pollen.

For the air conditioner to work with maximum efficiency, the pollution filter must be replaced at the intervals specified in the Service Plan.

If the filter loses efficiency prematurely due to use in areas reaching very high pollution levels, the pollen filter must be changed more frequently than stated in the Service Schedule.

Air conditioner

When the air conditioning system is switched on, not only the temperature, but also the air humidity in the vehicle interior is reduced. This improves

comfort for the vehicle occupants and prevents misting of the windows when the ambient air humidity is high.

If the air conditioning system cannot be switched on this may be caused by the following reasons:

- The engine is not running.
- The (AC) button is disconnected.
- The outside temperature is below +3 °C.
- The air conditioning system compressor has been temporarily switched off because the engine coolant temperature is too high.
- The air conditioner fuse is faulty.
- Another fault in the vehicle. Have the air conditioner checked by a specialised workshop.



CAUTION

- If you suspect that the air conditioner is damaged, switch it off with button (AC) to prevent further damage and have it checked by a specialised workshop.
- Repairs to the air conditioner require specialist knowledge and special tools. Therefore, we recommend you to take the vehicle to a specialised workshop.



Note

- If the humidity and temperature outside the vehicle are high, **condensation** can drip off the evaporator in the cooling system and so forming a puddle underneath the vehicle. This is completely normal and there is no need to suspect a leak.
- Keep the air intake slots in front of the windscreen free of snow, ice and leaves to ensure heating and cooling are not impaired, and to prevent the windows from misting over.
- The air from the vents flows through the vehicle interior and is extracted by slots designed for this purpose. Therefore, do not cover these slots with items of clothing or other objects. ▶

- The air conditioner operates most effectively with the windows and the sliding/tilting sunroof* closed. However, if the temperature inside the vehicle is excessive because of the sun, the air inside can be cooled faster by opening the windows for a short time.
- Do not smoke while air recirculation mode is on, as smoke drawn into the air conditioning system leaves a residue on the evaporator, producing a permanent unpleasant odour.
- It is advisable to connect the air conditioning at least once a month, to lubricate the system gaskets and prevent leaks. If a decrease in the cooling capacity is detected, a Technical Service should be consulted to check the system. ■

Driving

Steering

Adjusting the steering wheel position

The height and reach of the steering wheel can be freely adjusted to suit the driver.

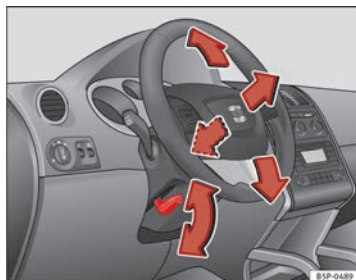

Fig. 132 Adjusting the steering wheel position

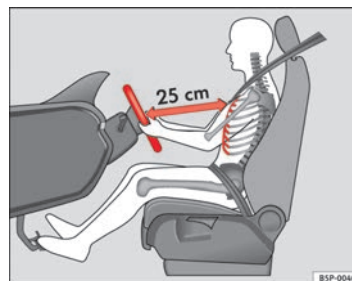

Fig. 133 Proper sitting position for driver

- Adjust the driver seat to the correct position.
- Push the lever under the steering column ⇒ Fig. 132 down ⇒ ⚠.
- Adjust the steering wheel until the correct position is set ⇒ Fig. 133.
- Then push the lever up again firmly ⇒ ⚠.



WARNING

- Incorrect use of the steering column adjustment function and an incorrect seating position can result in serious injury.
- To avoid accidents, the steering column should be adjusted only when the vehicle is stationary.

⚠ WARNING (Continued)

- Adjust the driver seat or steering wheel so that there is a distance of at least 25 cm between the steering wheel and your chest ⇒ Fig. 133. If you fail to observe the minimum distance, the airbag will not protect you. Risk of fatal injury.
- If your physical constitution does not allow you to maintain the minimum distance of 25 cm, contact a Technical Service. The Technical Service will help you to decide if special specific modifications are necessary.
- If you adjust the steering wheel so that it points towards your face, the driver airbag will not protect you properly in the event of an accident. Make sure that the steering wheel points towards your chest.
- When driving, always hold the steering wheel with both hands on the outside of the ring at the 9 o'clock and 3 o'clock positions. Never hold the steering wheel at the 12 o'clock position, or in any other manner (e.g. in the centre of the steering wheel, or on the inside of the rim). In such cases, if the airbag is triggered, you may sustain injuries to the arms, hands and head.

Safety

Electronic Stability Control (ESC)*

The ESC helps make driving safer in extreme driving conditions.



Fig. 134 Detailed view of the centre console: ESC switch.

The Electronic Stability Control ESC includes the electronic differential lock (EDL), the traction control system (ASR), the brake assist system (BAS) and the trailer stabilisation programme (TSP). The ESC works together with the ABS. Both control lamps will light up if the ESC or ABS systems are faulty.

The ESC system is started automatically when the engine is started.

The ESC system is always active and cannot be switched off. The ESC switch only switches the ASR off.

The ASR can be deactivated when wheel spin is desirable.

For example: ▶

- When driving with snow chains.
- When driving in deep snow or on loose surfaces.
- When the vehicle is stuck, to rock it backwards and forwards.

Press the button to switch the ASR back on when you no longer need wheel spin.

WARNING

- Do not forget that the Electronic stability control (ESC) cannot defy the laws of physics. This should be kept in mind, particularly on slippery and wet roads and when towing a trailer.
- Always adapt your driving style to suit the condition of the roads and the traffic situation. The greater safety provided by the ESC should not encourage you to run any risks.
- Please refer to the corresponding warning notes on ESC in ⇒ page 194, Intelligent technology.

Ignition lock

Position of the ignition key

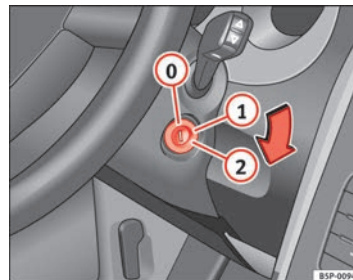



Fig. 135 Ignition key positions

Ignition switched off, steering lock 0

In this position ⇒ Fig. 135 the ignition and the engine are OFF and the steering may get locked.

For the **Steering lock** to operate without the ignition key, turn the steering wheel until it locks with an audible sound. You should always lock the steering wheel when you leave your vehicle. This will help prevent vehicle theft ⇒ .

Switching the ignition or the glow plug system on 1

Turn the ignition key to this position and release it. If the key cannot be turned or it is difficult to turn from position 0 to position 1, move the steering wheel from one side to the other until it is released. ▶

Starting ②

The engine is started when the key is in this position. Electrical components with a high power consumption are switched off temporarily.

Every time the vehicle is started again, the ignition key must be turned to position ①. The **repetitive start prevention lock** of the ignition prevents possible damage to the starter motor if the engine is already running.

⚠ WARNING

- The ignition key must NOT be removed from the lock until the vehicle comes to a standstill. Otherwise, the steering could be immediately blocked- Risk of accident!
- Always remove the key from the ignition when leaving the vehicle, even for a short period. This is especially important if children or disabled people are left alone in the vehicle. They could accidentally start the engine or work electrical equipment such as the electric windows, consequently resulting in an accident.
- Unsupervised use of the keys could start the engine or any electrical system, such as the electric window. This could result in serious injury.

⚠ CAUTION

The starter motor will only work when the engine is stopped (ignition key position ②).

Electronic immobiliser

The electronic immobiliser prevents unauthorised persons from driving the vehicle.

Inside the key there is a chip that deactivates the electronic immobiliser automatically when the key is inserted into the ignition.

The electronic immobiliser will be activated again automatically as soon as you pull the key out of the ignition lock.

The engine can only be started using a genuine SEAT key with its correct code.

**Note**

A perfect operation of the vehicle is ensured if genuine SEAT keys are used. ■

Starting and stopping the engine**Starting petrol engines**

The engine can only be started using a genuine SEAT key with its correct code.

- Move the gearbox lever to the neutral position and depress the clutch pedal thoroughly and hold it in this position for the starter to turn the engine on.
- Turn the ignition key to the starting ⇒ page 171 position.
- Let go of the ignition key as soon as the engine starts; the starter motor must not run on with the engine.

After starting a very hot engine, you may need to slightly press down the accelerator.

When starting a very cold engine, it may be a little noisy for the first few seconds until oil pressure has built up in the hydraulic valve compensators. This is quite normal, and no cause for concern. ►

If the engine does not start immediately, switch the starter off after 10 seconds and try again after half a minute. If the engine still does not start, the fuel pump fuse should be checked ⇒ page 268, Fuses.



WARNING

- **Never start or run the engine in unventilated or closed rooms. The exhaust gases contain carbon monoxide, an odourless and colourless poisonous gas. Risk of fatal accidents. Carbon monoxide can cause loss of consciousness. It can also result in death.**
- **Never leave the vehicle unattended if the engine is running.**
- **Never use “cold start sprays”, they could explode or cause the engine to run at high revs. Risk of injury.**



CAUTION

- When the engine is cold, you should avoid high engine speeds, driving at full throttle and over-loading the engine. Risk of engine damage.
- The vehicle should not be pushed or towed more than 50 metres to start the engine. Unburnt fuel could enter the catalytic converter and damage it.
- Before attempting to push-start or tow a vehicle in order to start it, you should first try to start it using the battery of another vehicle. Note and follow the instructions in ⇒ page 281, Jump-starting.



For the sake of the environment

Do not warm-up the engine by running the engine with the vehicle stationary. Start off immediately, driving gently. This helps the engine reach operating temperature faster and reduces emissions.

Starting diesel engines

The engine can only be started using a genuine SEAT key with its correct code.

- Move the gearbox lever to the neutral position and depress the clutch pedal thoroughly and hold it in this position for the starter to turn the engine on.
- Turn the ignition key to the starting position.
- Turn the ignition key to position ⇒ Fig. 135 ①. The warning lamp  will light for engine pre-heating.
- When the lamp turns off, turn the ignition key to position ② to start the engine. Do not press the accelerator.
- Let go of the ignition key as soon as the engine starts, the starter motor must not be allowed to run on with the engine.

When starting a very cold engine, it may be a little noisy for the first few seconds until oil pressure has built up in the hydraulic valve compensators. This is quite normal, and no cause for concern.

If there are problems starting the engine, see the ⇒ page 281.

Glow plug system for the diesel engine

To avoid unnecessary discharging of the battery, do not use any other major electrical equipment while the glow plugs are pre-heating.

Start the engine as soon as the glow plug warning lamp ⇒ page 83 goes out.

Starting the diesel engine after the fuel tank has been completely run dry

If the fuel tank has been completely run dry, it may take longer than normal (up to one minute) to start a diesel engine after refuelling. This is because the fuel system must eliminate air first. ▶

**WARNING**

- Never start or run the engine in unventilated or closed rooms. The exhaust gases contain carbon monoxide, an odourless and colourless poisonous gas. Risk of fatal accidents. Carbon monoxide can cause loss of consciousness. It can also result in death.
- Never leave the vehicle unattended if the engine is running.
- Never use “cold start sprays”, they could explode or cause the engine to run at high revs. Risk of injury.

**CAUTION**

- When the engine is cold, you should avoid high engine speeds, driving at full throttle and over-loading the engine. Risk of engine damage.
- The vehicle should not be pushed or towed more than 50 metres to start the engine. Unburnt fuel could enter the catalytic converter and damage it.
- Before attempting to push-start or tow a vehicle in order to start it, you should first try to start it using the battery of another vehicle. Note and follow the instructions in → page 281, Jump-starting.

**For the sake of the environment**

Do not warm-up the engine by running the engine with the vehicle stationary. You should drive off as soon as you start the engine. This helps the engine reach operating temperature faster and reduces emissions. ■

Switching off the engine

- Stop the vehicle.
- Turn the ignition key to position ⇒ Fig. 135 ①.

After switching the engine off, the radiator fan may run on for up to 10 minutes. It is also possible that the fan turns itself on once more if the coolant

temperature increases due to the heat accumulated in the engine compartment or due to its prolonged exposure to solar radiation.

**WARNING**

- Never switch the engine off until the vehicle is completely stationary.
- The brake servo works only when the engine is running. With the engine switched off, more strength is needed to brake. As normal brake operation cannot be performed, risk of accidents and serious injury may exist.
- The steering lock can be immediately blocked once the key is removed from the ignition. The vehicle cannot be steered. Risk of accident.

**CAUTION**

When the engine has been running under a heavy load for a long period, heat can accumulate in the engine compartment and cause engine damage. For this reason, you should idle the engine for approx. 2 minutes before you switch it off. ■

Driving with LPG*



Fig. 136 Centre console: gas system control switch.

Your SEAT vehicle has a bivalent engine able to run on either LPG or petrol. The LPG tank ⇒ page 228, Refuelling with LPG is in the spare wheel well ⇒ .

It is possible to change from LPG to petrol while the engine is running, even if the vehicle is moving, by pressing the **(GAS)** button located on the centre console ⇒ **Fig. 136**. The selected operating mode is displayed on the warning lamp on the instrument panel ⇒ page 79.

Starting the engine

The engine is always started with petrol, even when LPG was being used when it was switched off.

Automatic switch from petrol to LPG

When the engine is turned on and the following conditions are met, the system will automatically switch from petrol mode to LPG mode, the notification **changed to GAS mode** is displayed and the green warning lamp on the instrument panel lights up:

- There is enough LPG in the tank.
- The temperature of the vehicle coolant is above 30 °C.
- Engine speed while driving is above 1200 rpm.

Automatic switch from LPG to petrol

When the vehicle is operating in LPG mode and one of these conditions is met, the system automatically switches to petrol mode, the notification **changed to petrol mode** is displayed and the green warning lamp on the instrument panel goes out:

- When the engine is started.
- If the LPG tank is empty.
- If there is a fault in the LPG system.
- At very low temperatures below minus 10 °C.

Manual switch from petrol to LPG

Press the **(GAS)** button on the centre console ⇒ **Fig. 136** to change mode. The notification **changed to GAS mode** is displayed. When the following conditions are met, the system switches to LPG mode, the green warning lamp on the instrument panel lights up and the notification displayed changes to **changed to GAS mode**.

- There is enough LPG in the tank.
- The temperature of the vehicle coolant is above 30 °C.
- Engine speed while driving is above 1200 rpm.

Manual switch from LPG to petrol

Press the **(GAS)** button on the centre console ⇒ **Fig. 136** to change mode. The green lamp on the instrument panel goes out and the notification **changed to petrol mode** is displayed.

Running on petrol

Run the engine with petrol for short journeys at regular intervals to avoid problems in the petrol system. ▶

**WARNING**

LPG is a highly explosive and inflammable substance. It may cause severe burns and other injury.

- Due care must be taken to avoid any risk of fire or explosion.
- When parking the vehicle in a closed area (for example in a garage), make sure that there is adequate ventilation, either natural or mechanical, to neutralise the LPG in the event of a leak.

**Note**

- If frequent short journeys are made, especially when the outside temperature is low, the vehicle will tend to run on petrol more often than on LPG. Therefore, the petrol tank may empty before the LPG tank.
- The notification **LPG mode not possible** may be displayed.



Start-Stop function*

Description and operation

The Start-Stop function stops the engine when the vehicle is stopped and starts it automatically when required.



- When the vehicle is stopped, put it in neutral and release the clutch pedal. The engine will stop.
- When the clutch pedal is pressed, the engine starts again.
- The instrument panel display shows information about the status of the Start-Stop function ⇒ Fig. 138.

Start-Stop function conditions

- The driver seat belt must be buckled.
- The bonnet must be closed.
- The engine must be at operating temperature.
- The steering wheel must not be turned more than 270°.
- The vehicle must not be on a steep gradient.
- The vehicle must not be in reverse.
- A trailer must not be connected.
- The temperature of the passenger compartment must be within the comfort limits (button   ⇒ Fig. 131 should be selected).
- The windscreen de-mist function must be off.
- If **not**, it requires an increase in airflow  ⇒ Fig. 131 for more than three presses.
- The temperature must not be set to **HI** or **LO**.
- The driver door must be closed.
- The diesel particulate filter must not be in regeneration mode, for diesel engines.
- The battery charge must not be low for the next start.
- The battery temperature must be between -1 °C and 55 °C.
- The Parking aid system (Park Assist*) must not be activated.

Start-Stop function interruption

In the following situations, the Start-Stop function will be interrupted and the engine will automatically start:

- The vehicle starts moving.
- The brake pedal is pressed several times in a row.
- The battery has been discharged excessively.
- The Start-Stop System is manually deactivated.
- The windscreen de-mist function is turned on.
- The temperature of the passenger compartment exceeds the comfort limits (button   ⇒ Fig. 131 should be selected).

- If an increase in airflow (10) ⇒ Fig. 131 is required for more than three presses.
- Temperature setting **HI** or **LO** is selected.
- The engine coolant temperature is insufficient.
- The alternator is faulty, for example the V-belt has ruptured.
- If any of the conditions described in the previous section are not fulfilled.

WARNING

Never allow the vehicle to move with the engine off for any reason. You could lose control of your vehicle. This could cause an accident and serious injury.

- Power steering does not work when the engine is not running. That is why it is much more difficult to turn the steering wheel.
- Turn off the Start-Stop system when driving through water (fording streams, etc.).

Note

- For vehicles with the Start-Stop function and a manual gearbox, when the engine is started, the clutch must be pressed.
- When the conditions for the Start-Stop function are not fulfilled, the instrument panel displays the Start-Stop indicator dimmed.
- If the steering wheel is turned more than 270°, Stop will not function; however, the angle of steering wheel turn does not affect starting the vehicle.

Activating and deactivating the Start-Stop function

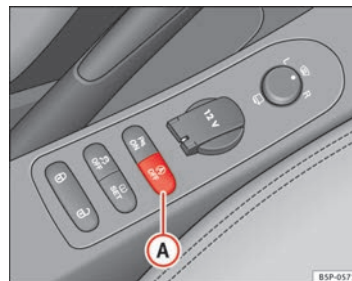



Fig. 137 The Start-Stop function button.

Every time the ignition is switched on, the Start-Stop function is automatically switched on.

Manually deactivating the Start-Stop function

- Press the  ⇒ Fig. 137 located in the centre console. When the Start-Stop function is deactivated, the pushbutton indicator lights.
- If the Start-Stop function is operating then the engine starts immediately.

Switching the Start-Stop function on manually

- Press the  ⇒ Fig. 137 located in the centre console. The indicator on the button will go out.

Driver messages



Fig. 138 Display on the instrument panel during Start-Stop function operation.

When the engine is turned off by the Start-Stop function, this is displayed on the instrument panel.

Note

There are different versions of the dash panel; the display of indications on the screen may differ. ■

Manual gearbox

Driving with a manual gearbox

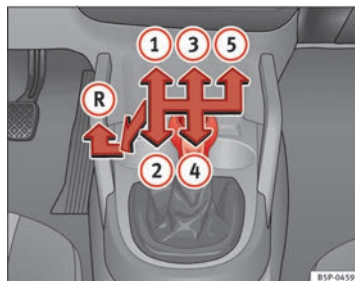

Fig. 139 Detailed view of the centre console: gear shift pattern of a 5-speed manual gearbox

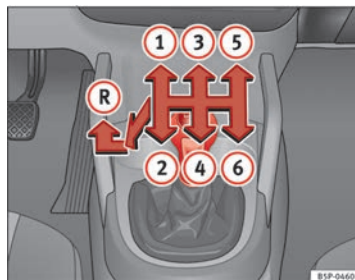

Fig. 140 Detailed view of the centre console: gear shift pattern of a 6-speed manual gearbox

Engaging the reverse gear

- The vehicle should be stationary with the engine idling. Press the clutch down thoroughly.
- Place the gearbox lever into neutral and push the lever downwards.
- Slide the gearbox lever to the left, and then into the reverse position shown on the lever.

The reverse gear can only be engaged when the vehicle is stationary. When the engine is running and before engaging this gear, wait about 6 seconds with the clutch pressed down thoroughly in order to protect the gearbox.

The reverse lights switch on when the reverse gear is selected and the ignition is on.

WARNING

- When the engine is running, the vehicle will start to move as soon as a gear is engaged and the clutch released.
- Never select the reverse gear when the vehicle is in motion. Risk of accident.

Note

- Do not rest your hand on the gear lever while driving. The pressure of your hand could cause premature wear on the selector forks in the gearbox.
- When changing gear, you should always depress the clutch fully to avoid unnecessary wear and damage.
- Do not hold the vehicle “on the clutch” on hills. This causes premature wear and damage to the clutch.
- Do not leave your foot on the clutch pedal; although the pressure may seem insignificant, it can cause the premature wear of the clutch plate. Use the foot rest when you do not need to change gear.

Automatic gearbox/DSG automatic gearbox*

Selector lever positions



Fig. 141 Centre console: Selector lever for automatic gearbox / DSG automatic gearbox

Selector lever positions indicated on the cover

- P** Parking position (lever locked).
- R** Reverse position.
- N** Neutral position (lever locked). This position is similar to the neutral position for manual gearboxes.
- D** Drive position (economic driving programme).
- S** Sports driving position.
- +/- Tiptronic driving position (this programme is similar to the operation of a manual gearbox).

Driving programmes

The automatic gearbox / DSG automatic gearbox has three programmes.



Fig. 142 Programme selection

Selecting the economy programme

- This programme selects a higher gear earlier rather than remain in a lower gear.
- Put the selector lever into position **D** to drive forwards
- Put the selector lever into position **R** to reverse. This position is shared by all programmes for reversing.

Selecting the sport programme

- Move the lever to position **S**.

If you select the sport programme, **S**, the programme is designed for a sports mode, that is, a programme which changes up at higher engine

speeds to use the full power of the engine. This programme is not recommended for use on the motorway or in the city.

Selecting the manual programme (tiptronic)

This programme allows driving similar to a manual gearbox.

This programme may be accessed using the selector lever or from the steering wheel controls when this option is fitted → page 183. ■

Selector lever locking

The selector lever lock prevents gears from being engaged inadvertently, which would cause the vehicle to move.

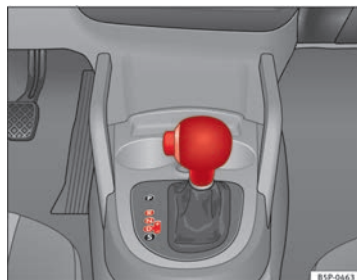

Fig. 143 Deactivating the lock

Releasing the selector lever lock

- Start the vehicle.
- Press and release the brake pedal, at the same time press the button on the selector lever.

The lock is only activated when the vehicle is stopped or at a speed of less than 5 km/h (3 mph). At higher speeds, the lock is automatically released in position **N**.

For rapid changes of position (e.g. from **R** to **D**) the lever will not lock. If the lever remains in the position **N** more than one second then it is locked. With the automatic lock, the lever is prevented passing from **P** and **N** to any other gear without first pressing the brake pedal.

The selector lever must be put in the position **P** in order to remove the key. ■

Driving with automatic gearbox/DSG automatic gearbox*

The drive and reverse gears are automatically engaged.



Fig. 144 Driving

Driving

- Press and hold the foot brake.
- Press on the button on the selector lever knob (on the left, → Fig. 144. ▶

- Select a gear for driving (**R**, **D** or **S**).
- Release the button and wait a few seconds for the gear to engage, a light jerk will be felt.
- Release the brake and accelerate.

Short stop

- Hold the vehicle stationary with the brake pressed down (for example at traffic lights). The selector lever does not need to be put into the positions **P** or **N** for this.
- Do not press the accelerator.

Parking

- Press the brake pedal and hold to bring the vehicle to a stop.
- Apply the handbrake firmly.
- Press in the button on the selector lever knob, move the lever to the position **P** and release the button.

Driving slowly

- Move the selector lever to position **D** and press to the right to put the lever into tiptronic mode.
- Press the gear lever towards (–) to select a lower gear.

Hill stop

- Hold the vehicle, in all cases, using the brake pedal to prevent rolling back.
- Do not try to slow the vehicle using another forward gear (engine braking).

Descending gradients

- With the gear engaged, release the brake and accelerate.

The steeper the gradient the lower the gear must be for effective engine braking. For example, if 3rd gear is used on a very steep gradient, the engine braking is insufficient and vehicle accelerates. So that the engine speed does not become excessive, the gearbox changes to the next highest gear. Depress the brake pedal and move the selector lever to the tiptronic gate to return to 3rd gear.



WARNING

- The driver should never leave the vehicle while the engine is running or with any gear selected. If for any reason you must leave the vehicle with the engine running, apply the handbrake and move the selector lever to position **P**.
- When the engine is running and the positions **D**, **S** or **R** are selected, it is necessary to hold the vehicle with the brake pedal because the vehicle will creep at a low speed.
- Never accelerate while changing the position of the gear lever (risk of an accident).
- The gear lever must never be moved into the positions **R** or **P** while moving (risk of an accident).
- Before descending a steep gradient, reduce speed and use the tiptronic programme to select a lower gear.
- If you must stop on a hill, always hold the vehicle using the footbrake to avoid rolling back.

⚠ WARNING (Continued)

- The footbrake must not be held for a long period of time, not even lightly; continuous braking will cause overheating of the brakes and a reduction or even a loss of braking power and a significant increase in braking distances.
- Never allow the vehicle to coast down a gradient with the selector lever in positions N or D, even when the engine is not running. For descents, the use of the tiptronic programme is recommended to keep the speed reduced.



CAUTION

- Never use the automatic gearbox to hold the vehicle stationary on a hill, even for short periods, as this may overheat the gearbox and cause damage. Apply the handbrake or depress the foot brake to hold the vehicle in position.
- If the vehicle is allowed to roll with the engine stopped but the selector in position N then the gearbox may be damaged because it will not be lubricated.

Changing gear in tiptronic mode*

The tiptronic system allows the driver to select gears manually

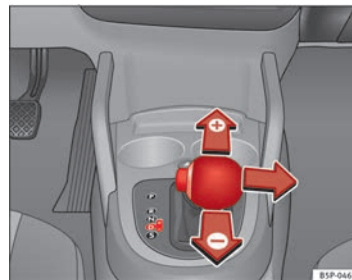



Fig. 145 Changing gear with tiptronic





Fig. 146 Steering wheel with levers for automatic gearbox

General information about driving in Tiptronic mode ▶

Changing gear with the selector lever

- Put the lever in position **D** and press towards the right to enter the tiptronic gate ⇒ Fig. 145.
- Press the gear lever forwards  ⇒ Fig. 145 to select a higher gear.
- Press the gear lever back  ⇒ Fig. 145 to select a lower gear.

Changing gear with the steering wheel levers

- Press the right paddle lever  (+OFF) towards the steering wheel to change up ⇒ Fig. 146.
- Press the left paddle  towards the steering wheel to change down ⇒ Fig. 146.

Using the paddle levers on the steering wheel, you can access manual driving mode regardless of the pre-selected driving mode.

General information about driving in tiptronic mode

When accelerating, the automatic gearbox / DSG automatic gearbox goes into a higher gear a little before the engine reaches its maximum permitted revolutions.

If a lower gear is selected, the automatic gearbox / DSG automatic gearbox will only change down when the engine cannot go over its maximum permitted revolutions.

If tiptronic is selected whilst the vehicle is in motion and the automatic gearbox / DSG automatic gearbox is in third gear and selector lever position **D**, tiptronic mode will then also be in third gear.

Changing gears in the normal or sport programme using the steering wheel paddle levers

If the paddle levers ⇒ Fig. 146 are used in the normal or sport programme, the system switches temporarily to tiptronic mode. To exit tiptronic mode

again, press the right paddle lever  towards the steering wheel for approximately one second. You will also leave “Tiptronic” mode if the paddle levers are not moved for a certain time.



Note

- The gearbox controls on the steering wheel can operate with the selector lever in any position and with the vehicle in motion. ■

Kick-down feature

This feature allows maximum acceleration.

If you press the accelerator down thoroughly, the gearbox automatically changes down, depending on speed and engine speed, into a lower gear to take full advantage of give the vehicle maximum acceleration.

The gearbox does not change gear until the engine reaches the maximum determined engine speed for the gear.



WARNING

You could lose control of the vehicle if you accelerate on slippery road surfaces. Risk of serious injury.

- **Be particularly careful when using the kick-down features on slippery road surfaces. With a fast acceleration, the vehicle could lose traction and skid.**
- **You should use the kick-down feature only when traffic and weather conditions allow it to be used safely.** ■

Handbrake

Using the handbrake

The handbrake should be applied firmly to prevent the vehicle from accidentally rolling away.

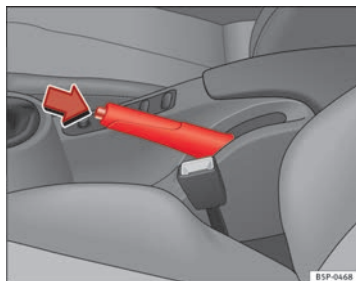

Fig. 147 Handbrake between the front seats

Always apply the handbrake when you leave your vehicle and when you park.

Applying the handbrake

- Pull the handbrake lever up firmly ⇒ Fig. 147.

Releasing the handbrake

- Pull the lever up slightly and press the release knob in the direction of the arrow ⇒ Fig. 147 and guide the handbrake lever down fully ⇒ ⚠.

Always apply the handbrake *as far as it will go* in order to prevent yourself from driving with the handbrake applied by mistake ⇒ ⚠.

The handbrake warning lamp  lights up when the handbrake is applied and the ignition switched on. The warning lamp turns off when the handbrake is released.

If you drive faster than 6 km/h (4 mph) with the handbrake on, the following message* will appear on the instrument panel display: **HANDBRAKE ON**. You will also hear an audible warning.

WARNING

- Never use the handbrake to stop the vehicle when it is in motion. The braking distance is considerably longer, because braking is only applied to the rear wheels. Risk of accident!
- If the handbrake is only partially released, this will cause the rear brakes to overheat, which can impair the function of the brake system and could lead to an accident. This also causes premature wear on the rear brake pads.

CAUTION

Always apply the handbrake before you leave the vehicle. The first gear should also be selected. ■

Parking

The handbrake should always be firmly applied when the vehicle is parked.

Always note the following points when parking the vehicle:

- Use the brake pedal to stop the vehicle. ▶

- Apply the handbrake.
- Select first gear.
- Switch the engine off and remove the key from the ignition. Turn the steering wheel slightly to engage the steering lock.
- Always take your keys with you when you leave the vehicle ⇒ ⚠.

Additional notes on parking the vehicle on gradients:

Turn the steering wheel so that the vehicle rolls against the kerb if it started to roll.

- If the vehicle is parked facing **downhill**, turn the front wheels so that they point *towards the kerb*.
- If the vehicle is parked facing **uphill**, turn the front wheels so that they point *away from the kerb*.
- Secure the vehicle as normal by applying the handbrake firmly and selecting first gear.

WARNING

- Take measures to reduce the risk of injury when you leave your vehicle unattended.
- Never park where the hot exhaust system could ignite inflammable materials, such as dry grass, low bushes, spilt fuel etc.
- Never allow vehicle occupants to remain in the vehicle when it is locked. They would be unable to open the vehicle from the inside, and could become trapped in the vehicle in an emergency. In the event of an emergency, locked doors will delay assistance to vehicle occupants.
- Never leave children alone in the vehicle. They could set the vehicle in motion, for example, by releasing the handbrake or the gearbox lever.
- Depending on weather conditions, it may become extremely hot or cold inside the vehicle. This can be fatal. ■

Hill-start aid*

This function is only included in vehicles with ESC.

This device helps when starting uphill.

These are the basic operation conditions: doors closed, brake pedal pressed down and vehicle in neutral. The system gets activated on engaging gear.

After removing your foot from the brake pedal, the braking force is maintained for a few seconds to prevent the vehicle from moving backward when putting into gear. This short space of time is enough to start the vehicle with ease.

This system also works when reversing uphill.

WARNING

- If you do not start the vehicle immediately after taking your foot off the brake pedal, the vehicle may start to roll back under certain conditions. Depress the brake pedal or use the handbrake immediately.
- If the engine stalls, depress the brake pedal or use the handbrake immediately.
- When following a line of traffic uphill, if you want to prevent the vehicle from rolling back accidentally when starting off, hold the brake pedal down for a few seconds before starting off.



Note

The Official Service or a specialised workshop can tell you if your vehicle is equipped with this system. ■

Parking aid acoustic system*

General notes

Various parking aid systems are available to help you when parking or manoeuvring in tight spaces, depending on the equipment fitted on your vehicle.

The SEAT Parking System* gives an audible warning if there are any obstacles behind your vehicle.

When you are parking, the SEAT Parking System Plus* warns you acoustically and optically¹⁾ about obstacles “in front of” and “behind” the vehicle.



Note

To ensure the acoustic parking aid works properly, the sensors must be kept clean and free of snow and ice.

SEAT Parking System: Description

The Parking System is an acoustic parking aid.

Sensors are located in the rear bumper. When the sensors detect an obstacle, you are alerted by audible warnings. The measuring range of the sensors starts at approximately:

Rear	Side	0,60
	Centre	1,60

¹⁾ Vehicles with a navigation system.

The audible warnings sound with increasing frequency as you approach the obstacle. When the vehicle is less than 0.30 m away from the obstacle, the warning tone will sound continuously. Do not drive on!

The volume of the warning beeps will be gradually reduced after about four seconds if the vehicle remains at a constant distance from a detected obstacle (it does not affect the permanent audible warning).

The parking aid is switched on automatically when reverse gear is engaged. You will hear a brief confirmation tone.



WARNING

- **The parking aid is not a replacement for driver awareness. The driver is personally responsible for safe parking and other manoeuvres.**
- **The sensors have blind spots in which obstacles are not registered. Always look out for small children and animals because the system will not always detect them. Always pay attention when reversing to avoid accidents.**
- **Always keep a close eye on the area around the vehicle and make full use of the rear vision mirrors.**



CAUTION

Please note that low obstacles detected by the system may no longer be registered by the sensors as the vehicle moves closer, so the system will not give any further warning. Certain kinds of obstacles (such as wire fences, chains, thin painted posts or trailer draw bars, etc) may not always be detected by the system, so take care not to damage the vehicle in such cases.



Note

Please refer to the notes on towing ⇒ page 189.

SEAT Parking System Plus*: Description

The Parking System Plus is an acoustic and optical parking aid.

Sensors are located in the front and rear bumpers. When the sensors detect an obstacle, you are alerted by audible and optical warnings. The measuring range of the sensors starts at approximately:

Front	Side	0,90
	Centre	1,20
Rear	Side	0,60
	Centre	1,60

The audible warnings sound with increasing frequency as you approach the obstacle. When the vehicle is less than 0.30 m away from the obstacle, the warning tone will sound continuously. Stop moving immediately!

The volume of the warning beeps will be gradually reduced after about four seconds if the vehicle remains at a constant distance from a detected obstacle (it does not affect the permanent audible warning).

Activating/Deactivating



Fig. 148 Centre console: Switch for parking aid

Activate

- Connects the radio navigator
- Press the switch P_{PA} on the centre console \Rightarrow Fig. 148 or on the gear indicator. You will hear a brief confirmation tone and the LED on the switch will light up.

Deactivating

- Drive forward faster than 10 km/h (6 mph), or
- Press the switch P_{PA} or
- Switch the ignition off.

Segments in the optical display

Some colour segments in front and behind and an audible warning enable the driver to assess the distance with respect to an obstacle. The amber colour segments combined with a discontinuous beep indicate the presence of ►

an obstacle. As the vehicle gets closer to the obstacle, the colour of the segment changes to red and the acoustic signal beeps continuously. When the penultimate segment is displayed, this means that the vehicle has reached the collision zone. Stop moving immediately! ⇒ ⚠.



WARNING

- The parking aid is not a replacement for driver awareness. The driver is personally responsible for safe parking and other manoeuvres.
- The sensors have blind spots in which obstacles are not registered. Always look out for small children and animals because the system will not always detect them. Always pay attention when reversing to avoid accidents.
- Always keep a close eye on the area around the vehicle and make full use of the rear vision mirrors.



CAUTION

Please note that low obstacles detected by the system may no longer be registered by the sensors as the vehicle moves closer, so the system will not give any further warning. Certain kinds of obstacles (such as wire fences, chains, thin painted posts or trailer draw bars, etc) may not always be detected by the system, so take care not to damage the vehicle in such cases.



Note

- Please refer to the notes on towing ⇒ page 189.
- There is a slight delay in the picture display.

Towing bracket

In towing mode, the rear parking aid sensors are not enabled when you select reverse gear or press the switch P_u. This function may not be guaran-

teed on towing brackets that are not factory fitted. This results in the following restrictions:

SEAT Parking System*

No warning is given

SEAT Parking System Plus*

There is no rear distance warning. The system will still give a warning when obstacles are detected while driving forward. The optical display changes to towing mode.

Fault messages

If you hear a long beep for a few seconds and the LED on the switch P_u* starts flashing when you switch on the parking aid, a system fault has occurred. Please refer the problem to a SEAT Official Service or specialised workshop.



Note

If the fault is not corrected before you switch off the ignition, it will only be indicated by the flashing LED on the switch P_u the next time you switch on the parking aid.

Cruise speed* (Cruise control system)

Description

The cruise control system is able to maintain the set speed in the range of 30 km/h (20 mph) to 180 km/h (110 mph).

Once the speed setting has been saved, you may take your foot off the accelerator.



WARNING

It could be dangerous to use the cruise control system if it is not possible to drive at constant speed.

- Do not use the cruise control system when driving in dense traffic, on roads with lots of bends or on roads with poor conditions (with ice, slippery surfaces, loose grit or gravel), as this could cause an accident.
- Always switch the cruise control system off after using it in order to avoid involuntary use.
- It is dangerous to use a set speed which is too high for the current road, traffic or weather conditions. Risk of accident.



Note

The cruise control cannot maintain a constant speed when descending downhill. The vehicle will accelerate due to its own weight. Use the foot brake to slow the vehicle.

¹⁾ Depending on the model version

Switching the cruise control system on and off

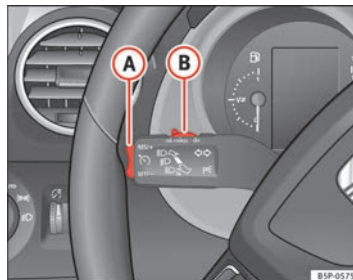



Fig. 149 Turn signal and main beam headlight lever: switch and rocker switch for the cruise control

Switching on the cruise control system

- Push the switch ⇒ Fig. 149 (A) to the left to ON.

Switching off the cruise control system

- Either push the switch (B) to the right to OFF or turn the ignition off when the vehicle is stationary.

When the cruise control is on and a speed is programmed, the indicator  on the instrument panel is lit.¹⁾

- If the cruise control system is switched off, the  symbol is switched off. The system will also be deactivated completely when 1st gear is selected.* ■

Setting speed*

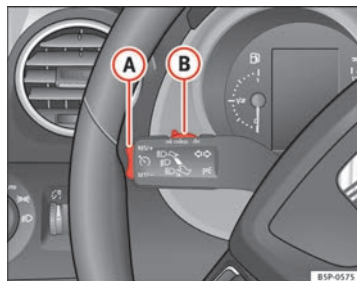

Fig. 150 Turn signal and main beam headlight lever; switch and rocker switch for the cruise control

- Press the lower part **SET/-** of the rocker switch ⇒ Fig. 150 **A** once briefly when you have reached the speed you wish to set.

When you release the rocker switch, the current speed is set and held constant.

Adjusting set speed*

The speed can be altered without touching the accelerator or the brake.

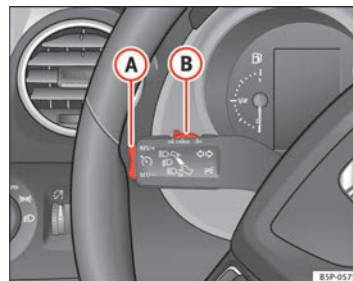

Fig. 151 Turn signal and main beam headlight lever; switch and rocker switch for the cruise control

Setting a higher speed

- Press the upper part **RES/+** of the rocker switch ⇒ Fig. 151 **A** to increase the speed. The vehicle will continue to accelerate as long as you keep the rocker switch pressed. When you release the switch, the new speed is stored.

Setting a lower speed

- Press the lower part **SET/-** of the rocker switch **A** to reduce the speed. The vehicle will automatically reduce its speed for as long as you keep the switch pressed. When you release the switch, the new speed is stored.

When you increase speed with the accelerator and then release the pedal, the system will automatically restore the set speed. This will not be the case, however, if the vehicle speed is more than 10 km/h (mph) higher than ▶

the stored speed for longer than 5 minutes. The speed will have to be stored again.

Cruise control is switched off if you reduce speed by depressing the brake pedal. You can reactivate the control by pressing once on the upper part of the rocker switch **RES/+** ⇒ Fig. 151 **(A)**.

WARNING

It is dangerous to use a set speed which is too high for the current road, traffic or weather conditions. Risk of accident.

Switching off cruise control temporarily*

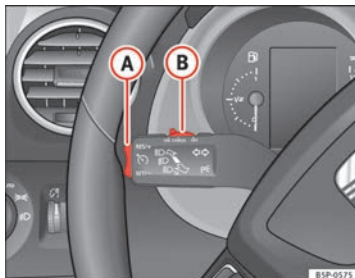

Fig. 152 Turn signal and main beam headlight lever: switch and rocker switch for the cruise control

The cruise control system will be switched off in the following situations:

- if the brake pedal is depressed,
- if the clutch pedal is depressed,
- if the vehicle is accelerated to over 180 km/h (110 mph),

- when the ESC or ASR is used.
- when the lever **(B)** is moved to the position “CANCEL” without reaching the “OFF” position. Once the “CANCEL” operation is completed, the lever is released and returns to its initial position.

To resume the cruise control, release the brake or clutch pedal or reduce the vehicle speed to less than 180 km/h (110 mph) and press once on the upper part of the rocker switch **RES/+** ⇒ Fig. 152 **(A)**.

WARNING

It is dangerous to use a set speed which is too high for the current road, traffic or weather conditions. Risk of accident.

Complete system deactivation*

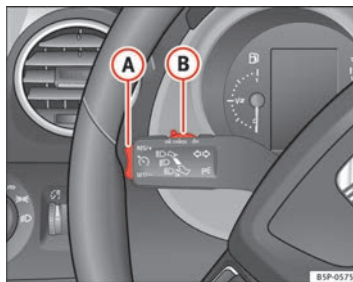

Fig. 153 Turn signal and main beam headlight lever: switch and rocker switch for the cruise control

Vehicles with a manual gearbox

The system is **completely turned off** by moving the control **(B)** all the way to the right hand side (OFF engaged), or when the vehicle is stationary, ignition off.

Vehicles with automatic gearbox/DSG automatic gearbox

To completely disengage the system, the selector lever must be placed in one of the following positions: **P, N, R** or **1** or with the vehicle stopped and the ignition turned off. ■

Practical Tips

Intelligent technology

Brakes

Brake servo

The brake servo increases the pressure you apply to the brake pedal. It works **only when the engine is running**.

If the brake servo is not functioning due to a malfunction, or if the vehicle has to be towed, you will have to press the brake pedal considerably harder to make up for the lack of servo assistance.



WARNING

The braking distance can also be affected by external factors.

- **Never let the vehicle coast with the engine switched off. Failure to do so could result in an accident. The braking distance is increased considerably when the brake servo is not active.**
- **If the brake servo is not working, for example when the vehicle is being towed, you will have to press the brake pedal considerably harder than normal.**

Hydraulic Brake Assist (HBA)*

The function (Hydraulic Brake Assist HBA) is only included in vehicles with ESC.

In an emergency, most drivers brake in time, but not with maximum force. This results in unnecessarily long braking distances.

This is when the brake assist system comes into action. When pressing the brake pedal rapidly, the assistant interprets it as an emergency. It then very quickly builds up the full brake pressure so that the ABS can be activated more quickly and efficiently, thus reducing the braking distance.

Do not reduce the pressure on the brake pedal. The brake assist system switches off automatically as soon as you release the brake.

Emergency braking warning

If the vehicle is braked suddenly and continuously at a speed of more than 80 km/h (50 mph), the brake light flashes several times per second to warn vehicles driving behind. If you continue braking, the hazard warning lights will come on automatically when the vehicle comes to a standstill. They switch off automatically when the vehicle starts to move again. ▶

 **WARNING**

- The risk of accident is higher if you drive too fast, if you do not keep your distance to the vehicle in front, and when the road surface is slippery or wet. The increased accident risk cannot be reduced by the brake assist system.
- The brake assist system cannot defy the laws of physics. Slippery and wet roads are dangerous even with the brake assist system! Therefore, it is essential that you adjust your speed to suit the road and traffic conditions. Do not let the extra safety features tempt you into taking any risks when driving.

Anti-lock brake and traction control systems M-ABS (ABS and ASR)

Anti-lock brake system (ABS)

The anti-lock brake system prevents the wheels locking during braking.

The anti-lock brake system (ABS) is an important part of the vehicle's active safety system.

How the ABS works

If one of the wheels is turns too slowly in relation to the road speed, and is close to locking, the system will reduce the braking pressure for this wheel. The driver is made aware of this control process by a **pulsating of the brake pedal** and audible noise. This is a deliberate warning to the driver that one or more of the wheels is tending to lock and the ABS control function has intervened. In this situation it is important to keep the brake pedal fully depressed so the ABS can regulate the brake application. Do not "pump".

If you brake hard on a slippery road surface, the best possible control is retained as the wheels do not lock.

However, ABS will not necessarily guarantee shorter braking distances in *all* conditions. The braking distance could even be longer if you brake on gravel or on fresh snow covering a slippery surface.

 **WARNING**

- The anti-lock brake system cannot defy the laws of physics. Slippery and wet roads are dangerous even with ABS! If you notice that the ABS is working (to counteract locked wheels under braking), you should reduce speed immediately to suit the road and traffic conditions. Do not let the extra safety features tempt you into taking any risks when driving.
- The effectiveness of ABS is also determined by the tyres fitted
⇒ page 250.
- If the running gear or brake system is modified, the effectiveness of the ABS could be severely limited.

Drive wheel traction control system (ASR)

The traction control system prevents the driven wheels from spinning when the vehicle is accelerating.

Description and operation of the traction control system during acceleration (ASR)

On front-wheel drive vehicles, the ASR system intervenes, reducing engine power and preventing the driven wheels from slipping during acceleration. The system works in the entire speed range in conjunction with ABS. If a failure occurs in the ABS, the ASR will also stop working.

The ASR helps the car to start moving, accelerate and climb a gradient in slippery conditions, where this may otherwise be difficult or even impossible.

The ASR automatically switches on when the engine is started. If necessary, it may be turned on or off by briefly pushing the button on the centre console.

When the ASR is switched off, the  warning lamp will light up. The ASR should normally be left on. Only in exceptional circumstances, when the slipping of the wheels is required, it will be necessary to have it disconnected, for example.

- With compact temporary spare wheel.
- When using the snow chains.
- When driving in deep snow or on loose surfaces
- When the vehicle is bogged-down, to free it by rocking.

The ASR should be switched on again as soon as possible.



WARNING

- Remember that not even the ASR can defy the laws of physics. This should be kept in mind, particularly on slippery and wet roads and when towing a trailer.
- Always adapt your driving style to suit the condition of the roads and the traffic situation. The greater safety provided by the ASR should not encourage you to run any risks.



CAUTION

- To ensure that the ASR works correctly, identical tyres should be fitted on all four wheels. Any differences in the rolling radius of the tyres can cause the system to reduce engine power when this is not desired.
- Any modifications made to the vehicle (for example, to the engine, brake system, running gear or to the combination of wheels and tyres) may affect the operation of the ABS and ASR.

XDS*

Driveshaft differential

When taking a bend, the driveshaft differential mechanism allows the outer wheel to turn at a higher speed than the inner wheel. In this way, the wheel that is turning faster (outer wheel) receives less drive torque than the inner wheel. This may mean that in certain situations the torque delivered to the inner wheel is too high, causing the wheels to spin. On the other hand, the outer wheel is receiving a lower drive torque than it could transmit. This causes an overall loss of lateral grip on the front axle, resulting in under-steer or “lengthening” of the trajectory.

The XDS system can detect and correct this effect via the sensors and signals of the ESC.

Via the ESC, the XDS will brake the inside wheel and counter the excess driving torque of that wheel. This means that the driver's desired trajectory is much more precise,

The XDS system works in combination with the ESC and is always active, even when the ASR traction control is disconnected. ■

Electronic Stability Control (ESC)*

General notes

The Electronic Stability Control increases the vehicle's stability on the road.

■ The Electronic Stability Control helps reduce the danger of skidding.

The Electronic Stability Control (ESC) includes the **ABS, EDL, ASR and Steering manoeuvre recommendation** systems. ►

Electronic Stability Control (ESC)*

The ESC reduces the risk of skidding by braking the wheels individually.

The system uses the steering wheel angle and road speed to calculate the changes of direction desired by the driver, and constantly compares them with the actual behaviour of the vehicle. When irregularities occur, for example, if the vehicle begins to skid, the ESC brakes the appropriate wheel automatically.

The forces acting on the braked wheel bring the vehicle back to a stable condition. If the vehicle tends to oversteer, the system will act on the front wheel on the outside of the turn.

Steering manoeuvre recommendations

This is a complementary safety function included in the ESC. This function aids the driver to better stabilize the vehicle in a critical situation. For example, in case of sudden braking surface with varied adherence, the vehicle will tend to destabilise its trajectory to the right or to the left. In this case, the ESC recognises the situation and assists the driver with a counter steering manoeuvre from the power steering.

This function simply provides the driver with a recommended manoeuvre in critical situations.

The vehicle does not steer itself with this function, the driver has full control of the vehicle at all times.

**WARNING**

- Remember that not even the ESC can defy the laws of physics. This should be kept in mind, particularly on slippery and wet roads and when towing a trailer.
- Always adapt your driving style to suit the condition of the roads and the traffic situation. The greater safety provided by the ESC should not encourage you to run any risks.

**CAUTION**

- To ensure that the ESC works correctly, all four wheels must be fitted with the same tyres. Any differences in the rolling radius of the tyres can cause the system to reduce engine power when this is not desired.
- Any modifications made to the vehicle (for example, to the engine, brake system, running gear or to the combination of wheels and tyres) may affect the operation of the ABS, EDL, ESC and ASR.

Anti-lock brake system (ABS)

The anti-lock brake system prevents the wheels locking during braking
⇒ page 195.

Electronic differential lock (EDL)*

The electronic differential lock helps prevent the loss of traction caused if one of the driven wheels starts spinning.

EDL helps the vehicle to start moving, accelerate and climb a gradient in slippery conditions where this may otherwise be difficult or even impossible.

The system will control the revolutions of the driven wheels using the ABS sensors (in case of an EDL fault the warning lamp for ABS lights up)
⇒ page 84.

At speeds of up to approximately 80 km/h, it is able to balance out differences in the speed of the driven wheels of approximately 100 rpm caused by a slippery road surface on *one side* of the vehicle. It does this by braking the wheel which has lost traction and distributing more driving force to the other driven wheel via the differential.

To prevent the disc brake of the braking wheel from overheating, the EDL cuts out automatically if subjected to excessive loads. The vehicle will continue to function normally without EDL. For this reason, the driver is not informed that the EDL has been switched off.

The EDL will switch on again automatically when the brake has cooled down.



WARNING

- **When accelerating on a slippery surface, for example on ice and snow, press the accelerator carefully. Despite EDL, the driven wheels may start to spin. This could impair the vehicle's stability.**
- **Always adapt your driving style to suit road conditions and the traffic situation. Do not let the extra safety afforded by EDL tempt you into taking any risks when driving, this can cause accidents.**



CAUTION

Modifications to the vehicle (e.g. to the engine, the brake system, running gear or any components affecting the wheels and tyres) could affect the efficiency of the EDL ⇒ page 224. ■

Drive wheel traction control system (ASR)

The traction control system prevents the driven wheels from spinning when the vehicle is accelerating ⇒ page 195. ■

All-wheel drive*

On all-wheel drive models, the engine power is distributed to all four wheels

General notes

The all-wheel drive system operates completely automatically. The propulsion force is distributed among the four wheels and adapted to the driving style and the road conditions.

The all-wheel drive is specially designed to complement the superior engine power. This combination gives the vehicle exceptional handling and performance capabilities, both on normal roads and in more difficult conditions, such as snow and ice.

Winter tyres

Thanks to its all-wheel drive, your vehicle will have plenty of traction in winter conditions, even with the standard tyres. Nevertheless, we still recommend that winter tyres or all-season tyres should be fitted on all four wheels when winter road conditions are expected, mainly because this will give a better braking response.

Snow chains

On roads where snow chains are mandatory, this also applies to cars with all-wheel drive.

Changing tyres

On vehicles with all-wheel drive, all four tyres must have the same rolling circumference ⇒ page 255. ▶

**WARNING**

- Even with all-wheel drive, you should always adjust your speed to suit the conditions. Do not let the extra safety features tempt you into taking any risks when driving. Failure to do so could result in an accident.
- The braking capability of your vehicle is limited by the tyres' grip. Vehicle behaviour is no different from a vehicle without four-wheel drive. So do not be tempted to drive too fast on icy or slippery roads just because the vehicle still has good acceleration in these conditions. Failure to do so could result in an accident.
- On wet roads bear in mind that the front wheels may start to aquaplane and lose contact with the road if the vehicle is driven too fast. If this should happen, there will be no sudden increase in engine speed when aquaplaning begins to warn the driver, as with a front-wheel drive vehicle. For this reason and for that mentioned above, always choose a driving speed suitable for the road conditions. Failure to do so could result in an accident.

Brakes

What factors can have a negative effect on the brakes?

New brake pads

New brake pads do not provide optimal performance during the first 400 km (250 miles); first they must be "run in". However, the reduced braking capacity may be compensated by pressing on the brake pedal a little harder. Avoid overloading the brakes during run-in.

Wear

The rate of wear on the **brake pads** depends a great deal on how you drive and the conditions in which the vehicle is operated. Negative factors are, for instance, city traffic, frequent short trips or hard driving with abrupt starts and stops.

Wet roads or road salt

In certain conditions, such as in heavy rain, or after washing the vehicle or driving through water, the full braking effect can be delayed by moisture (or in winter by ice) on the discs and brake pads. In this case the brakes should be dried by pressing the brake pedal several times.

The effectiveness of the brakes can also be temporarily reduced if the vehicle is driven for some distance without using the brakes when there is a lot of salt on the road in winter. In this case, the layer of salt on the brake discs and pads has to wear off before braking.

Corrosion

There may be a tendency for corrosion to form on the discs and dirt to build up on the brake pads if the vehicle is used infrequently or the brakes are not used very often.

If the brakes are not used frequently, or if rust has formed on the disks, it is advisable to clean off the pads and disks by braking firmly a few times at a moderately high speed ⇒ ⚠.

Faults in the brake system

If the brake pedal travel should ever increase *suddenly*, this may mean that one of the two brake circuits has failed. Drive immediately to the nearest specialised workshop and have the fault repaired. Drive there slowly and remember that you will have to apply more pressure on the brake pedal and allow for longer stopping distances.

Low brake fluid level

Malfunctions can occur in the brake system if the brake fluid level is too low. The brake fluid level is monitored electronically.

Brake servo

The brake servo increases the pressure you apply to the brake pedal. The brake servo works only when the engine is running. ▶

**WARNING**

- Apply the brakes heavily to clean the brake system only in a suitable traffic situation. Be sure not to inconvenience or endanger other road users. Risk of accident.
- Ensure the vehicle does not move while in neutral, when the engine is stopped. Failure to do so could result in an accident.

**CAUTION**

- Never let the brakes “drag” by leaving your foot on the pedal when it is not necessary to brake. This overheats the brakes, resulting in longer stopping distances and greater wear.
- Before driving down a long, steep gradient, it is advisable to reduce speed and change to a lower gear (or move the gear lever to a lower gear position if your vehicle has an automatic gearbox). This makes use of engine braking and prolongs the useful life of the brakes. If you still have to use the brakes, it is better to brake firmly at intervals than to apply the brakes continuously.

**Note**

- If the brake servo is not functioning due to a malfunction, or if the vehicle has to be towed, you will have to press the brake pedal considerably harder to make up for the lack of servo assistance.
- If you wish to equip the vehicle with accessories such as a front spoiler or wheel covers, it is important that the flow of air to the front wheels is not obstructed, otherwise the brakes can overheat.

Power steering (servotronic*)

Power steering makes it easier to turn the steering wheel when the engine is running.

Power steering assists the driver by reducing the force needed to turn the steering wheel. In cars equipped with servotronic* power steering the degree of power assistance is regulated *electronically* according to road speed.

The power *steering* will keep on working even if the *servotronic** device fails. The degree of power assistance will, however, no longer adapt to different speeds. If the electronic regulating system is not working properly, this is most noticeable when turning the steering wheel at low speeds (for instance when parking), as more effort will be required than usual. The fault should be corrected by a specialised workshop as soon as possible.

Power steering does not work if the engine is off. In this case the steering wheel requires much more force to turn.

If the steering is held at its *turning limit* when the vehicle is stationary, this will place an excessive load on the power steering system. Turning the steering wheel to its limit places a load on the system, which causes noise. It will also reduce the idling speed of the engine.

**CAUTION**

When the engine is running, do not turn the steering wheel to its limit for more than 15 seconds. Otherwise, there is a risk of damaging the power steering.

**Note**

- If the power steering should fail at any time or the engine is switched off (for instance when being towed), the vehicle can still be steered. However, more effort will be required to turn the steering wheel.
- If the system is leaking or malfunctioning, please take the vehicle to a specialised workshop as soon as possible.
- The power steering system requires a special hydraulic fluid. The container is located in the engine compartment (front left). The correct fluid level in the reservoir is important for the power steering to function properly. The hydraulic fluid level is checked at the Inspection Service. ■

Driving and the environment

Running-in

Running in a new engine

The engine needs to be run in over the first 1500 km (1000 miles).

Up to 1000 kilometres (600 miles)

- Do not drive at speeds of more than 2/3 the maximum speed.
- Do not accelerate hard.
- Avoid high engine revolutions.
- Do not tow a trailer.

From 1000 to 1500 kilometres (600 to 900 miles)

- Speeds can be *gradually* increased to the maximum road speed or maximum permissible engine speed (rpm).

During its first few hours of running, the internal friction in the engine is greater than later on, when all the moving parts have bedded in.



For the sake of the environment

If the engine is run in gently, its life will be increased and its oil consumption reduced.

Braking capacity and braking distance

The braking capacity and braking distance are influenced by driving situations and road conditions.

The efficiency of the brakes depends directly on the **brake pad** wear. The rate of wear of the brake pads depends to a great extent on the conditions under which the vehicle is operated and the way the vehicle is driven. If you often drive in town traffic, drive short distances or have a sporty driving style, we recommend that you have the thickness of your brake pads checked by a Technical Service more frequently than recommended in the Service Plan.

If you drive with **wet brakes**, for example, after crossing areas of water, in heavy rainfall or even after washing the vehicle, the effect of the brakes is lessened as the brake discs are wet or even frozen (in winter). In this case the brakes should be dried by pressing the brake pedal several times.



WARNING

Longer braking distances and faults in the brake system increase the risk of accidents.

- **New brake pads must be run in and do not have the correct friction during the first 400 km (120 miles). However, the reduced braking capacity may be compensated by pressing on the brake pedal a little harder. This also applies when the brake pads have to be changed further on.**
- **If brakes are wet or frozen, or if you are driving on roads which have been salted, braking power may be lower than normal.**

⚠ WARNING (Continued)

- On steep slopes, if brakes are excessively used, they will overheat. Before driving down a long steep slope, it is advisable to reduce speed and change down into a lower gear or range (depending on the type of transmission). This makes use of engine braking and relieves the brakes.
- Never let the brakes “drag” by applying light pressure. Continuous braking will cause the brakes to overheat and the braking distance will increase. Apply and then release the brakes alternately.
- Never let the vehicle run with the engine switched off. The braking distance is increased considerably when the brake servo is not active.
- If the brake fluid loses its viscosity and is subjected to heavy use, vapour bubbles can form in the brake system. This reduces the efficiency of the brakes.
- Non-standard or damaged front spoilers could restrict the airflow to the brakes and cause them to overheat. Before purchasing accessories please observe the relevant instructions ⇒ page 224, Technical modifications.
- If a brake system circuit fails, the braking distance will be increased considerably. Contact a specialised workshop immediately and avoid unnecessary journeys.

Exhaust gas purification system

Catalytic converter*

To maintain the useful life of the catalytic converter

- Use only unleaded petrol with petrol engines, as lead damages the catalytic converter.
- Do not let the fuel get too low in the tank.

- For engine oil changes, do not replenish with too much engine oil ⇒ page 238, Topping up engine oil .
- Never tow the vehicle to start it, use jump leads if necessary ⇒ page 281.

If you notice misfiring, uneven running or loss of power when the vehicle is moving, reduce speed immediately and have the vehicle inspected at the nearest specialised workshop. In general, the exhaust gas warning lamp will light up when any of the described symptoms occur ⇒ page 77. If this happens, unburnt fuel can enter the exhaust system and escape into the environment. The catalytic converter can also be damaged by overheating.

⚠ WARNING

The catalytic converter reaches very high temperatures! Risk of fire!

- Never park where the catalytic converter could come into contact with dry grass or flammable materials under the vehicle.
- Do not apply additional underseal or anti-corrosion coatings to the exhaust pipes, catalytic converter or the heat shields on the exhaust system. These materials could catch fire when the vehicle is being driven.

**CAUTION**

Never run the fuel tank completely dry because the irregularity of the fuel supply may cause ignition problems. This allows unburnt fuel to enter the exhaust system, which could cause overheating and damage the catalytic converter.

**For the sake of the environment**

Even when the emission control system is working perfectly, there may be a smell of sulphur from the exhaust gas under some conditions. This depends on the sulphur content of the fuel used. Quite often the problem can be solved by changing to another brand of fuel.

Diesel engine particulate filter*

The diesel engine particulate filter eliminates soot produced by burning diesel.



Fig. 154 Vehicle data sticker on back cover of the Maintenance Programme

Your vehicle is fitted with a DPF (Diesel particulate filter) if the vehicle data sticker (back cover of the “Maintenance Programme”) lists the PR code 7GG or 7MG ⇒ Fig. 154.

The diesel engine particulate filter eliminates most of the soot from the exhaust gas system. Under normal driving conditions, the filter cleans itself. If driving conditions do not allow the filter to clean itself (for example, multiple short trips) the filter will be obstructed by dust and pollen and the diesel engine particulate filter warning lamp  will light up. This does not represent a fault, it is a warning that indicates that the filter has not been able to regenerate automatically and that you must carry out a cleaning cycle, as indicated in ⇒ page 83.



WARNING

- The diesel engine particulate filter may reach extremely high temperatures; the vehicle should be parked so that the exhaust pipe does not come into contact with flammable materials underneath the vehicle. Otherwise there is a risk of fire.



CAUTION

- Your vehicle is **not** designed to use biodiesel fuel. **Never, under any circumstances** refuel with biodiesel. The use of biodiesel fuel could damage the engine and the fuel system. The addition of biodiesel to diesel by the diesel producer in accordance with standard EN 590 is authorised and will not cause damage to the engine or the fuel system.
- Using diesel fuel with a high sulphur content may significantly reduce the useful life of the diesel particulate filter. Your Technical Service will be able to tell you which countries have diesel with a high sulphur content. ■

Economical and environmentally friendly driving

Economical and environmentally friendly driving

Fuel consumption, environmental pollution and wear to the engine, brakes and tyres depends in large part on your driving style. By adopting an economical driving style and anticipating the traffic situation ahead, you can easily reduce fuel consumption by 10-15%. Some tips on how to help you reduce pollution while saving money are listed below.

Drive anticipating the traffic situation

A vehicle uses most fuel when accelerating. When you anticipate the situation, you have to brake less often and, thus, accelerate less. If it is possible, ►

let the vehicle roll with a **gear engaged**, for example, if you see a red light ahead. The braking effect achieved in this way helps to reduce the wear of brakes and tyres; emissions and fuel consumption are reduced to zero (disconnection due to inertia).

Change gear early to save energy

An effective way of saving fuel is to change up *quickly* through the gears. Running the engine at high rpm in the lower gears uses an unnecessary amount of fuel.

Manual gearbox: Change from first to second gear as quickly as possible. We recommend that, whenever possible, you change to a higher gear upon reaching 2000 rpm. Follow the “recommended gear” indication that appears on the instrument panel ⇒ page 62.

Avoid driving at high speed

We advise you not to drive at the top speed permitted by the vehicle. Fuel consumption, exhaust emissions and noise levels all increase very rapidly at higher speeds. Driving at moderate speeds will help to save fuel.

Avoid idling

It is worthwhile switching off the engine when waiting in a traffic jam, at level crossings or at traffic lights with a long red phase. The fuel saved after only 30 - 40 seconds is greater than the amount of fuel needed to restart the engine.

The engine takes a long time to warm up when it is idling. Mechanical wear and pollutant emissions are also especially high during this initial warm-up phase. It is therefore best to drive off immediately after starting the engine. Avoid running the engine at high speed.

Periodic maintenance

Periodic maintenance work guarantees that, before beginning a journey, you will not consume more than the required amount of fuel. A well-serviced engine gives you the benefit of **improved fuel efficiency** as well as maximum reliability and an enhanced resale value.

A badly serviced engine can consume up to 10% more fuel than necessary.

Avoid short journeys

To reduce the consumption and emission of polluting exhaust gases, the engine and the exhaust gas filtration systems should reach the optimum **operating temperature**.

With the engine cold, fuel consumption is proportionally higher. The engine does not warm up and fuel consumption does not normalise until having driven approximately *four* kilometres (2.5 miles). This is why we recommend avoiding short trips whenever possible.

Maintain the correct tyre pressures

Bear in mind that keeping the tyres at an adequate pressure saves fuel. If the tyre pressure is just one bar too low, fuel consumption can increase by as much as 5%. Due to the greater rolling resistance, under-inflation also increases **tyre wear** and impairs handling.

The tyre pressures should always be checked when the tyres are *cold*.

Do not use **winter tyres** all year round as they increase fuel consumption by up to 10%.

Avoid unnecessary weight

Given that every kilo of **extra weight** will increase the fuel consumption, it is advisable to always check the luggage compartment to make sure that no unnecessary loads are being transported.

A roof rack is often left in place for the sake of convenience, even when it is no longer needed. At a speed of 100-120 km/h (60-75 mph) your vehicle will use about 12% more fuel as a result of the extra wind resistance caused by the roof rack even when it is not in use.

Save electricity

The engine activates the alternator, which produces electricity. With the need for electricity, fuel consumption is also increased. Because of this, always turn off electrical components when you do not need them. Examples of components that use a lot of electricity are: the fan at high speeds, the rear window heating or the seat heaters*.

**Note**

- If your vehicle has *Start-Stop*, it is not recommended to switch this function off.
- It is recommended to *close the windows* when driving at more than 60 km/h (40 mph)
- Do not drive with your foot resting *on the clutch pedal*, as the pressure can make the plate spin, more fuel will be used and it can burn the clutch plate lining, causing a serious fault.
- Do not hold the vehicle on a hill with the clutch, use the foot brake or hand brake, using the latter to start. The fuel consumption will be lower and you will prevent the clutch plate from being damaged.
- On descents, use the engine brake, changing to the gear that is more suitable for the slope. The fuel consumption will be lower and the brakes will not suffer.

Environmental friendliness

Environmental protection is a top priority in the design, choice of materials and production of your new Seat.

Design measures for economical recycling

- Joints and connections designed for easy dismantling
- Modular construction to facilitate dismantling
- Increased use of single-grade materials
- Plastic parts and elastomers are marked in accordance with ISO 1043, ISO 11469 and ISO 1629

Choice of materials

- Nearly all materials used can be recycled
- Similar types of plastics grouped together for easy recycling
- Recycled materials used in manufacture

- Reduction of volatile compounds in plastics
- CFC-free refrigerant in air conditioner

Compliance with prohibited materials regulation: cadmium, lead, mercury, chrome VI.

Manufacturing methods

- Use of recycled material for manufacturing plastic parts
- Solvent-free cavity sealing
- Solvent-free wax for protecting the vehicles in transit
- Solvent-free adhesives
- No CFCs used in production
- Surplus materials used extensively for energy conversion and building materials
- Overall water consumption reduced
- Heat recovery systems
- The use of water-soluble paints

Driving abroad

Observations

To drive abroad, the following must be taken into consideration:

- For vehicles fitted with a catalytic converter ensure that unleaded petrol is available for the journey. See the chapter "Refuelling". Automobile organisations will have information about service station networks selling unleaded fuel.
- In some countries, it is possible that your vehicle model is not sold, and therefore spare parts are not available or the Technical Services can only carry out limited repairs.

SEAT importers and distributors will gladly provide information about the technical preparations that your vehicle requires and also about necessary maintenance and repair possibilities. ■

Adhesive strips for headlights

If you have to drive a right-hand drive vehicle in a left-hand drive country, or vice versa, the asymmetric dipped beam headlights will dazzle oncoming traffic.

To prevent dazzling, you must apply stickers to certain parts of the headlight lenses. Further information is available at your Technical Service.

In vehicles with adaptive headlights, the rotation system must previously be disconnected. To do this, please go to a specialised workshop. ■

Trailer towing

Instructions to follow

Your vehicle may be used to tow a trailer when fitted with the correct equipment.

If the vehicle is supplied with a **factory-fitted** towing bracket it will already have the necessary technical modifications and meet the statutory requirements for towing a trailer. If you wish to **retrofit** a towing bracket, consult → page 210.

Connectors

Your vehicle is fitted with a 12-pin connector for the electrical connection between the trailer and the vehicle.

If the trailer has a **7-pin plug** you will need to use an adapter cable. This is available in any Technical Service.

Trailer weight/drawbar load

Never exceed the authorised trailer weight. If you do not load the trailer up to the maximum permitted trailer weight, you can then climb correspondingly steeper slopes.

The maximum trailer weights listed are only applicable for **altitudes** up to 1000 m above sea level. With increasing altitude the engine power and therefore the vehicle climbing ability are impaired because of the reduced air density. The maximum trailer weight has to be reduced accordingly. The weight of the vehicle and trailer combination must be reduced by 10% for every further 1000 m (or part thereof). The gross combination weight is the actual weight of the laden vehicle plus the actual weight of the laden trailer. When possible, operate the trailer with the maximum permitted **drawbar load** on the ball joint of the towing bracket, but do not exceed the specified limit.

The figures for **trailer weights** and **drawbar loads** that are given on the data plate of the towing bracket are for certification purposes only. The correct figures for your specific model, which may be *lower* than these figures for the towing bracket, are given in the vehicle documentation or in → chapter Technical Data.

Distributing the load

Distribute loads in the trailer so that heavy objects are as near to the axle as possible. Loads carried in the trailer must be secured to prevent them moving.

Tyre pressure

Set tyre pressure to the maximum permissible pressure shown on the sticker on the inside of the fuel tank flap. Set the tyre pressure of the trailer tyres in accordance with the trailer manufacturer's recommendations.

Exterior mirrors

Check whether you can see enough of the road behind the trailer with the standard rear vision mirrors. If this is not the case, you should have additional exterior mirrors fitted. Both exterior mirrors should be mounted on hinged extension brackets. Adjust the mirrors to give sufficient vision to the rear.



WARNING

Never transport people in a trailer. This could result in fatal accidents. ▶

**Note**

- Towing a trailer places additional demands on the vehicle. We recommend additional services between the normal inspection intervals if the vehicle is used frequently for towing a trailer.
- Find out whether special regulations apply to towing a trailer in your country.

Ball coupling of towing bracket*

Depending on the model version, the spherical head on the trailer hook may be stored in the tool box.

The ball coupling is provided with instructions on fitting and removing the ball coupling of the towing bracket.

**WARNING**

The towing bracket ball coupling must be stored securely in the luggage compartment to prevent them being flung through the vehicle and causing injury.

**Note**

- By law, the ball coupling must be removed if a trailer is not being towed if it obscures the number plate.

Driving tips

Driving with a trailer always requires extra care.

Weight distribution

- The weight distribution of a loaded trailer with an unladen vehicle is very unfavourable. However, if this cannot be avoided, drive extra slowly to allow for the unbalanced weight distribution.

Speed

The stability of the vehicle and trailer is reduced with increasing speed. For this reason, it is advisable not to drive at the maximum permissible speed in an unfavourable road, weather or wind conditions. This applies especially when driving downhill.

You should always reduce speed immediately if the trailer shows the slightest sign of **snaking**. Never try to stop the “snaking” by increasing speed.

Always brake in due course. If the trailer has an **overrun brake**, apply the brakes *gently at first* and then, *firmly*. This will prevent the jerking that can be caused by locking of trailer wheels. Select a low gear in due course before going down a steep downhill. This enables you to use the engine braking to slow down the vehicle.

Reheating

At very high temperatures and during prolonged slopes, driving in a low gear and high engine speed, always monitor the coolant temperature gauge ⇒ page 55.

Electronic Stability Control*

The ESC* system helps to stabilise the trailer in case of skidding or rocking. ■

Fitting a towing bracket*

It is possible to fit a towing bracket to the rear of the vehicle.

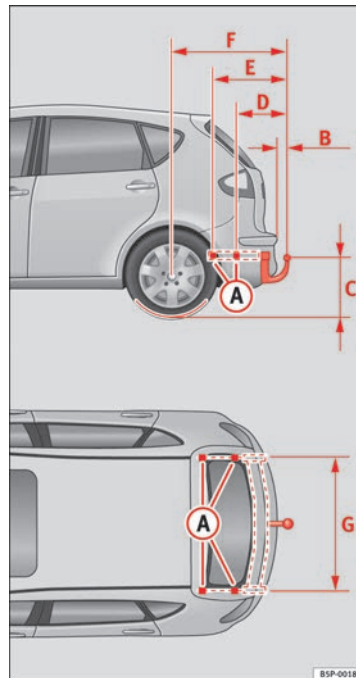

Fig. 155 Attachment points for towing bracket

If a towing bracket is to be fitted after the vehicle is purchased, this must be completed according to the instructions of the towing bracket manufacturer. ►

The attachment points for the towing bracket **A** are on the lower part of the vehicle.

The distance between the centre of the ball coupling and the ground should never be lower than the indicated value, even with a fully loaded vehicle and including the maximum drawbar load.

Elevation values for securing the towing bracket:

- B** 65 mm (minimum)
- C** 350 mm to 420 mm (fully laden vehicle)
- D** 357 mm
- E** 569 mm
- F** 875 mm
- G** 1040 mm

Fitting a towing bracket

- Driving with a trailer involves an extra effort for the vehicle. Therefore, before fitting a towing bracket, please contact a Technical Service to check whether your cooling system needs modification.
- The legal requirements in your country must be observed (e.g. the fitting of a separate control lamp).
- Certain vehicle components, e.g. the rear bumper, must be removed and reinstalled. The towing bracket securing bolts must be tightened using a torque wrench, and a power socket must be connected to the vehicle electrical system. This requires specialised knowledge and tools.
- Figures in the illustration show the elevation value and the attachment points which must be considered if you are retrofitting a towing bracket.



WARNING

The towing brackets should be fitted at a specialised workshop.

- If the towing bracket is incorrectly installed, there is a serious danger of accident.
- For your own safety, please observe the instructions provided by the manufacturer of the towing bracket.



CAUTION

- If the power socket is incorrectly installed, this could cause damage to the vehicle electrical system.



Note

For the sports model (FR), fitting of a trailer bracket is not recommended due to the design of the bumpers. ■

Vehicle maintenance and cleaning

General notes

Regular washing and care help maintain the value of your vehicle.

Vehicle maintenance

Regular care and washing help to **maintain the value** of the vehicle. This may also be one of the requirements for acknowledging warranty claims in the event of bodywork corrosion or paint defects.

The best way to protect your vehicle against the harmful effects of the environment is through correct maintenance and *frequent* washing. The longer substances such as insect remains, bird droppings, resinous tree sap, road dirt, industrial deposits, tar, soot or road salt and other aggressive materials remain on the vehicle, the more damage they do to the paintwork. High temperatures (for instance in strong sunlight) further intensify the corrosive effect.

After winter, a period when salt is put on the roads, it is important to have the **underside** of the vehicle washed thoroughly.

Products for vehicle maintenance

Car-care products are available in your Technical Services. Keep the product instructions until you have used them up.



WARNING

- Car-care products can be toxic. Because of this, they must always be kept closed in their original container. Keep them out of the reach of children. Failure to comply could result in poisoning.
- Always read and observe the instructions and warnings on the package before using car-care products. Improper use could cause health problems or damage the vehicle. The use of certain products may produce noxious vapours; they should be used in well ventilated areas.
- Never use fuel, turpentine, engine oil, nail varnish remover or other volatile fluids. These are toxic and highly flammable. Risk of fire and explosion.
- Before washing your vehicle, or carrying out any maintenance, switch the engine off, apply the handbrake firmly and remove the key from the ignition.



CAUTION

Never attempt to remove dirt, mud or dust if the surface of the vehicle is dry. Never use a dry cloth or sponge for cleaning purposes. This could damage the paintwork or the windows of your vehicle. Soak dirt, mud or dust with plenty of water.



For the sake of the environment

- When purchasing products for your vehicle maintenance, select the ones which are not harmful to the environment.
- The waste from car-care products should not be disposed of with ordinary household waste. Observe the disposal information on the package. ■

Care of the vehicle exterior

Automatic car wash tunnel

The vehicle can normally be washed without problem in an automatic car wash.

The vehicle paintwork is so durable that the vehicle can normally be washed without problems in an automatic car wash tunnel. However, the paintwork wear depends to a large extent on the kind of the car wash tunnel, the brushes used, its water filtering and the type of cleaning and preservative products.

Before going through a vehicle wash, be sure to take the usual precautions such as closing the windows and sunroof.

If the vehicle has special accessories such as spoilers or a roof rack or two-way radio aerial, etc., it is advisable to consult the car wash tunnel operator.

After washing, the **brakes** could take some time to respond as the brake discs and pads could be wet, or even frozen in winter. Dry the brakes by braking several times.



WARNING

Water, ice and salt on the brake system can reduce braking effectiveness. Risk of accident.



CAUTION

If an automatic car wash tunnel is used, before entering the tunnel, put the aerial down parallel to the roof and do not tighten to avoid damage. ■

Washing by hand

Vehicle washing

- First soften the dirt and rinse it off with water.
- Clean your vehicle from top to bottom with a soft sponge, a glove or a brush. Use very light pressure.
- Rinse the sponge or glove often with clean water.
- Special car shampoo should only be used for very stubborn dirt.
- Leave the wheels, sill panels etc. until last, using a different sponge or glove.
- Rinse the vehicle thoroughly with water.
- Dry the vehicle surface gently with a chamois leather.
- In **cold temperature**, dry the rubber seals and their surfaces to prevent them from freezing. Apply silicone spray to the rubber seals.

After washing the vehicle

- After washing, avoid sudden and sharp braking. Dry the brakes by braking several times ⇒ page 202, Braking capacity and braking distance. ▶

**WARNING**

- Wash your vehicle with the ignition switched off.
- Protect your hands and arms from cuts on sharp metal edges when cleaning the underbody, the inside of the wheel housings etc. Risk of injury.
- Water, ice and salt on the brake system can reduce braking effectiveness. Risk of accident.

**CAUTION**

- Never remove dirt, mud or dust if the vehicle surface is dry. Never use a dry cloth or sponge for cleaning purposes. This could scratch the paintwork or glass on your vehicle.
- Washing the vehicle in low temperatures: when washing the vehicle with a hose, do not direct water into the lock cylinders or the gaps around the doors, rear lid, or sunroof. Risk of freezing.

**For the sake of the environment**

To protect environment, the vehicle should be washed only in specially provided wash bays. This prevents toxic, oil-laden waste water entering the sewerage system. In some places, washing vehicles outside wash bays is prohibited.

**Note**

Do not wash the vehicle in direct sunlight.

Washing the vehicle with a high pressure cleaner

Be particularly careful when using a high pressure cleaner!

- Always observe the instructions for the high-pressure cleaner, particularly those concerning the **pressure** and the **spraying distance**.
- Increase the spraying distance for soft materials and painted bumpers.
- Do not use a high pressure cleaner to remove ice or snow from windows ⇒ page 215.
- Never use concentrated jet nozzles (“rotating jets”) ⇒
- After washing, avoid sudden and sharp braking. “Dry” the brakes by braking several times ⇒ page 202.

**WARNING**

- **Never wash tyres with a concentrated jet (“rotating nozzle”). Even at large spraying distances and short cleaning times, visible and invisible damage can occur to the tyres. This may cause an accident.**
- **Water, ice and salt on the brake system can reduce braking effectiveness. Risk of accident.**

**CAUTION**

- Do not use water hotter than 60 °C. This could damage the vehicle.
- To avoid damage to the vehicle, keep a sufficient distance from sensitive materials such as flexible hoses, plastic, soundproofing material, etc. This is also important for bumpers painted in the colour of the bodywork. The closer the nozzle is to the surface, the greater the wear on the material.

Vehicle paint maintenance

Regular waxing protects the paintwork.

You need to apply wax to your vehicle if water does not form small drops and run off the paintwork when it is *clean*.

Good quality *hard wax* products are available at your Technical Service.

Regular wax applications help to protect the paintwork from environmental contaminants. ⇒ page 212. It also protects against minor scratches.

Even if a **wax solution** is used regularly in the vehicle washing tunnel, it is advisable to protect the paint with a hard wax coating at least twice a year. ■

Polishing the paintwork

Polishing brings back gloss to the paintwork.

Polishing is only necessary if the paint has lost its shine, and the gloss cannot be brought back by applying wax. Polishing products can be purchased in your Technical Service.

The vehicle must be waxed after polishing if the polish used does not contain wax compounds to seal the paint ⇒ page 215, Vehicle paint maintenance.



CAUTION

To prevent damage to the paintwork:

- Do not use polishes and hard wax on painted parts with a matt finish or on plastic parts.
- Do not polish your vehicle in a sandy or dusty environment. ■

Caring for plastic parts

Solvents damage plastic parts.

If normal washing fails to clean plastic parts, clean them with approved **solvent-free** plastic cleaning and care products.



CAUTION

- The use of liquid air freshener directly over the air vents of the vehicle may damage the plastic parts if the liquid is accidentally spilled.
- Cleaning products which contain solvents will damage the material. ■

Cleaning windows and exterior mirrors

Cleaning windows

- Moisten the windows with commercially available, alcohol based glass cleaner.
- Dry the windows with a clean chamois leather or a lint-free cloth.

Removing snow

- Use a small brush to remove snow from the windows and mirrors.

Removing ice

- Use a de-icer spray.

Use a clean cloth or chamois leather to dry the windows. The chamois leathers used on painted surfaces are not suitable to clean windows because they are soiled with wax deposits which could smear the windows. ►

If possible, use a de-icing spray to remove ice. If you use an ice scraper, push it in one direction only without swinging it.

Use window cleaner or a silicone remover to clean rubber, oil, grease and silicone deposits off.

Wax deposits can be removed with a special cleaner available in your Technical Services. Wax deposits on the windscreen could cause the wiper blades to judder. Adding a window cleaner that dissolves wax to the windscreen washer fluid prevents wiper blades from juddering, but wax deposits are not removed.



CAUTION

- Never use warm or hot water to remove snow and ice from windows and mirrors. This could cause the glass to crack!
- The heating element for the rear window is located on the inner side of the window. To prevent damage, do not put stickers over the heating elements on the inside of the window.

Cleaning windscreen wiper blades

Clean wiper blades improve visibility.

1. Use a soft cloth to remove dust and dirt from the windscreen wiper blades.
2. Use window cleaner to clean the windscreen wiper blades. Use a sponge or a cloth to remove stubborn dirt.

Rubber seals maintenance

If rubber seals are well looked after, they will not freeze so quickly.

1. Use a soft cloth to remove dust and dirt from the rubber seals.
2. Apply a specialist care product to the rubber seals.

The rubber strips on the doors, windows, bonnet and rear lid will remain pliable and last longer if they are treated with a suitable care product (for example silicone spray).

Caring for rubber seals will also prevent premature ageing and leaks. The doors will be easier to open. If rubber seals are well looked after, they will not freeze so quickly in winter.

Door lock cylinders

The door lock cylinders can freeze up in winter.

To de-ice the lock cylinders you should only use spray with lubricating and anti-corrosive properties.

Cleaning chrome parts

1. Clean chrome parts with a damp cloth.
2. Polish chrome parts with a soft, dry cloth.

If this does not provide satisfying results, use a specialist **chrome cleaning product**. Chrome cleaning products will remove stains from the surface.

**CAUTION**

To prevent scratching chrome surfaces:

- Never use an abrasive cleaning product on chrome.
- Do not clean or polish chrome parts in a sandy or dusty environment. ■

Steel wheel rims

- Clean steel wheel rims regularly using a separate sponge.

Use an industrial cleaner to remove brake dust. Any damage to the paint on steel wheel rims should be repaired before starting to rust.

**WARNING**

- Never wash tyres with a cylindrical jet. Even at large spraying distances and short cleaning times, visible and invisible damage can occur to the tyres. This may cause an accident.
- Water, ice and salt on the brake system can reduce braking effectiveness. Risk of accident. Directly after washing, avoid sudden and sharp braking. Dry the brakes by braking several times ⇒ page 202. ■

Alloy wheel rims**Every two weeks**

- Wash salt and brake dust from alloy wheels.
- Use an acid free detergent to clean the wheel rims.

Every three months

- Apply a hard wax compound to the wheels.

Alloy wheels require regular attention to preserve their appearance. If road salt and brake dust are not often removed, the aluminium finish will be impaired.

Always use an acid-free detergent for alloy wheel rims.

Car polish or other abrasive agents should not be used for maintaining the rims. If the protective coating is damaged, e.g. by flying stones, the damaged area should be repaired immediately.

**WARNING**

- Never wash tyres with a cylindrical jet. Even at large spraying distances and short cleaning times, visible and invisible damage can occur to the tyres. This may cause an accident.
- Water, ice and salt on the brake system can reduce braking effectiveness. Risk of accident. Directly after washing, avoid sudden and sharp braking. Dry the brakes by braking several times ⇒ page 202. ■

Underbody protection

The vehicle underbody is coated to protect it from chemical and mechanical damage.

The protective coating can be damaged when driving. We recommend you to check the protective coating under the body and on the running gear, and reinstated if necessary, before and after the winter season.

We recommend you to go to your Technical Service to carry out repair work and additional anti-corrosion work. ▶

**WARNING**

Do not apply underseal or anti-corrosion coatings to the exhaust pipes, catalytic converter or the heat shields on the exhaust system. The heat of the exhaust system or the engine could cause them to ignite. Risk of fire. ■

Cleaning the engine compartment

Take special care when cleaning the engine compartment.

Anti-corrosion treatment

The engine compartment and the surface of the power unit are given anti-corrosion treatment at the factory.

Good corrosion protection is particularly important in winter when the vehicle is frequently driven on salted roads. To prevent the salt corroding the vehicle, the entire engine compartment should be thoroughly cleaned before and after winter.

Your Technical Services have got the necessary workshop equipment to provide the correct cleaning and preserving products. For this reason, we recommend having this work performed by them.

The anti-corrosion protection is usually removed if the engine compartment is cleaned with grease removing solutions, or if you have the engine cleaned. On commissioning this work, ensure that all surfaces, seams, joints and components in the engine compartment are given anti-corrosion treatment.

**WARNING**

- When working in the engine compartment, always observe the safety warnings ⇒ page 233.
- Before opening the bonnet, switch the engine off, apply the hand-brake firmly and always remove the key from the ignition.
- Allow the engine to cool before you clean the engine compartment.
- Do not clean the vehicle underbody, wheel arches or wheel trims without protecting your hands and arms. You may cut yourself on sharp-edged metal parts. Failure to comply could result in injury.
- Moisture, ice and salt on the brake system may affect braking effectiveness. Risk of accident. Directly after washing, avoid sudden and sharp braking.
- Never touch the radiator fan. It is temperature-controlled and could start automatically, even when the key is removed from the ignition!

**For the sake of the environment**

Fuel, grease and oil deposits could be removed when the engine is washed. The polluted water must be cleaned in an oil separator. For this reason, engine washing should be carried out only by a specialised workshop or a petrol station. ■

Vehicle interior maintenance

Introduction

The dye used in many modern garments, for example dark jeans, is not always sufficiently colour-fast. Seat upholstery (material and leather), especially when light-coloured, may visibly discolour if the dye comes out of clothing (even when used correctly). This is not an upholstery defect but indicates that the dye in the item of clothing is not sufficiently colour-fast. ►

The longer stains or dirt remain on the vehicle surfaces, especially the fabrics covering the padded upholstery, the more difficult it becomes to clean and maintain them. If stains and dirt are left for a long time, it may be that they are impossible to remove.

WARNING

Car-care products may be toxic and hazardous. Using unsuitable car-care products or, using them in the wrong way, may cause accidents, serious injury, burns or intoxication.

- Keep your car-care products in their original containers.
- Read the instructions.
- Never keep car-care products in empty food containers, bottles or other similar containers, other people may confuse them.
- Keep all car-care products out of the reach of children.
- Some products may give off harmful vapours during use. Therefore, they should be used outdoors in well-ventilated places.
- Never use fuel, turpentine, engine oil, nail-varnish remover or any other volatile product for washing, maintenance or cleaning. These are toxic and highly flammable.

WARNING

Unsuitable maintenance and cleaning of vehicle components may impair proper operation of safety equipment and cause serious injury.

- Maintain and clean vehicle components according to the manufacturer's instructions.
- Only use approved or recommended cleaning products.

CAUTION

- Cleaning products which contain solvents have a corrosive effect and may damage the material irreparably.
- Stains and dirt containing aggressive substances or solvents attack the material and may damage it irreparably, even when they are cleaned quickly.
- Dirt and stains should not be allowed to dry and should be cleaned as quickly as possible.
- In the case of stubborn stains, take the vehicle to a specialised workshop to avoid damage.

Treating your upholstery

Checklist

To treat and maintain your seat upholstery, keep the following in mind ⇒ :

- ✓ Before entering the vehicle, close any Velcro fasteners that might snag on the upholstery or trim fabric. Any open Velcro fasteners may damage the trim or upholstery fabrics.
- ✓ To prevent damage, avoid direct contact between sharp decorative objects and the upholstery and trim fabrics. Decorative objects include zips, rivets and rhinestones on clothing and belts.
- ✓ From time to time, clean the dust that gathers in the perforations, folds and seams so that the surfaces of the seats are not damaged by its abrasive effect.
- ✓ Make sure clothes are colour-fast to avoid them running and staining the upholstery. This is especially important if the upholstery is light in colour.

**CAUTION**

If you ignore this checklist, which is important for maintaining your seat upholstery, the fabric may be damaged or stained.

- Consult the checklist and carry out the operations it describes.

**Note**

SEAT recommends you take the vehicle to a specialised workshop to treat any stains on the upholstery caused by the discolouration of clothing. ■

How to clean the upholstery, trim fabrics and Alcantara®

Cleaning the fabric on heated seats and electrically adjustable seats or seats with airbag components

It is possible that there are important airbag components and electrical connections inside the driver seat, passenger seat and possibly the outer rear seats. If these seats and backrests are damaged, or are cleaned and are treated incorrectly, or if they get wet, the vehicle electric system may be destroyed and the airbag system damaged ⇒ ⚠.

Electric and heated seats contain components and electrical connections that may be damaged if the seats are cleaned or incorrectly treated ⇒ ⚠. Similarly, damage might be caused at other points in the vehicle's electric system.

For this reason, bear the following indications in mind for cleaning:

- Do not use high-pressure or steam cleaning equipment or cold aerosols.
- Do not use cream detergents or detergent-based solutions for delicate garments.
- Prevent the fabric from getting wet at all times.
- Only use cleaning products approved by SEAT.
- If in doubt, take the vehicle to a professional cleaning company.

Cleaning the fabric on unheated seats, non-electrically adjustable seats and seats without airbag components

- Before using any cleaning products, consult and keep in mind the instructions of use, indications and warnings on the container.
- Use a vacuum cleaner (with the brush attachment) on the trim and seat fabrics, the Alcantara® upholstery of the seats and the carpet.
- Do not use high-pressure or steam cleaning equipment or cold aerosols.
- For general cleaning, use a soft sponge or an ordinary lint-free microfibre cloth ⇒ Ⓐ.
- Clean Alcantara® surfaces with a slightly damp cotton or woollen cloth, or a standard lint-free microfibre cloth ⇒ Ⓐ.

If the dirt on the trim and upholstery fabrics is only superficial, you can use a standard foam cleaner.

If the upholstery and trim are very dirty, before cleaning them we recommend you find out about the most suitable cleaning options from a professional cleaning company. If necessary, the cleaning should be carried out by a specialised company.

Stain removal

When removing stains, it may be necessary to clean the whole surface and not just the stain itself. Especially if the surface has been dirtied through normal use. If you only clean the stained area, that part may then look lighter than the rest. If in doubt, take the vehicle to a professional cleaning company.

**WARNING**

If there is a fault in the airbag system, it is likely that the airbag will not deploy correctly, not deploy at all, or do so unexpectedly, which could cause serious or fatal injuries.

- **Have the system checked immediately by a specialised workshop.** ▶

**CAUTION**

If the upholstery on electrically operated seats or seats with airbag components gets soaked, the vehicle's electric system and certain other components may be damaged.

- If the seat gets soaked, take the vehicle immediately to a specialised workshop to be dried and for the system components to be inspected.
- Do not use steam cleaning equipment as the dirt becomes more encrusted and fixed in the material.
- High-pressure cleaning equipment and cold aerosols may damage the upholstery.

**CAUTION**

- Brushes should only be used to clean the carpet and floor mats! Other fabrics may be damaged if cleaned with a brush.
- If cream detergents or detergents for delicate garments are applied with a damp cloth or sponge, they may, for example, leave rings when dry because of the tensioactive components they contain. Generally, such rings are very difficult or almost impossible to remove.

**CAUTION**

- Do not let water soak into Alcantara® under any circumstances.
- Do not use leather cleaning products, solvents, wax polish, shoe cream, stain removers or similar products on Alcantara®.
- Never use brushes for cleaning damp material as they could damage the surface. ■

Cleaning and maintenance of natural leather upholstery

Consult a professional cleaning workshop if you have any doubts on cleaning and maintaining the leather equipment in your vehicle.

Maintenance and treatment

Nappa natural leather is delicate because it has no additional protective layer.

- After cleaning, regularly apply a conditioner with sun-screen and impregnating action. These products nourish the leather, soften it and make it more breathable, as well as re-hydrating it. They also provide it with a protective film.
- Clean the leather every two or three months and remove stains as they appear.
- Treat the leather regularly (about twice a year) with a suitable maintenance product.
- Apply as few cleaning and maintenance products as possible, always using a dry, lint-free cotton or woollen cloth. Do not apply cleaning and maintenance products directly to the leather.
- Remove recent ball-point pen and ink stains, lipstick, shoe cream and similar stains as soon as possible.
- Maintain the colour of the leather. To do this, use a special cream especially coloured for leather to achieve the same overall colour, if necessary.
- Afterwards, go over it with a soft cloth.

Cleaning the vehicle

SEAT recommends using a slightly damp cotton or woollen cloth for general cleaning purposes.

Generally, the leather should never be soaked at any point, nor should water penetrate the seams.

Before cleaning the leather upholstery, bear in mind the following recommendations ⇒ page 220, Cleaning the fabric on heated seats and electrical adjustable seats or seats with airbag components. ▶

**CAUTION**

- On no account use solvents, wax polish, shoe cream, stain removers or similar materials on leather.
- If the stain remains on the leather for long, it will soak in and be impossible to remove.
- In the event of spilt liquids, dry immediately with an absorbent cloth to prevent the liquid penetrating through the leather or seams.
- If the vehicle is left standing in the sun for long periods, the leather should be protected against direct sunlight to prevent it from fading.

**Note**

The leather will usually change colour slightly with use.

Cleaning synthetic leather upholstery

Before cleaning the synthetic leather upholstery, bear in mind the following recommendations ⇒ page 220, Cleaning the fabric on heated seats and electrically adjustable seats or seats with airbag components

Only use water and neutral cleaning products to clean synthetic leather upholstery.

**CAUTION**

Do not use solvents, floor wax, shoe cream, stain removers or similar products on synthetic leather. These will stiffen the material, causing it to crack prematurely.

Plastic parts and dash panel cleaning

- Use a clean, damp cloth to clean plastic parts and the dash panel.
- If this does not provide satisfactory results, use a special **solvent-free** plastic cleaning product.

**WARNING**

Never clean the dash panel and the airbag module surface with cleaners containing solvents. Solvents cause the surface to become porous. If the airbag triggered, plastic parts could become detached and cause injuries.

**CAUTION**

Cleaning products which contain solvents will damage the material.

Wooden trim cleaning*

- Clean the wooden trim with a water-moistened clean cloth.
- If this does not provide satisfactory results, use a *gentle* soap solution.

**CAUTION**

Cleaning products which contain solvents will damage the material.

Cleaning the radio and climate controls

To clean the radio and/or climate controls, use a soft damp cloth. For more resistant dirt, a neutral soap solution may be used. ■

Seat belt cleaning

A dirty belt may not work properly.

Check all seat belts regularly and keep them clean.

Seat belt cleaning

- Pull the dirty seat belt right out and unroll it.
- Clean dirty seat belts with a *gentle* soap solution.
- Allow it to dry.
- Do not roll the seat belt up until it is dry.

If large stains form on the belts, it will not retract correctly into the automatic belt retractor.



WARNING

- Do not use chemical cleaning agents on the seat belts, as this can impair the strength of the webbing. Ensure that seat belts do not come into contact with corrosive fluids.
- Check the condition of the seat belts at regular intervals. If you notice that the belt webbing, fittings, retractor mechanism or buckle of any of the belts is damaged, the belt must be replaced by a specialised workshop.
- Do not attempt to repair a damaged seat belt yourself. The seat belts must not be removed or modified in any way.



CAUTION

After cleaning, allow seat belts to dry completely before rolling them up. Otherwise, the belt retractors could become damaged. ■

Accessories, replacement of parts and modifications

Accessories and spare parts

Always consult a SEAT dealership before purchasing accessories and parts.

Your vehicle is designed to offer a high standard of active and passive safety.

Before purchasing accessories and parts, and before making technical changes to your vehicle, we recommend that you consult your Technical Service.

SEAT dealerships will be happy to provide you with the latest information about the use, legal requirements and recommendations from the manufacturer regarding accessories and spare parts.

We recommend you use only **SEAT Approved Accessories®** and **SEAT Approved Spare Parts®**. This way, SEAT can guarantee that the product in question is suitable, reliable and safe. SEAT Technical Services have the necessary experience and facilities to ensure that parts are correctly and professionally installed.

Despite a continuous observation of the market, SEAT is not able to assess the reliability, safety and suitability of parts that **SEAT has not approved**. For this reason, SEAT cannot assume responsibility for any non-genuine parts used, even if these parts have been approved by an official testing agency or are covered by an official approval certificate.

Any **equipment subsequently installed** which has a direct effect on the driver's control of the vehicle (e.g. cruise control system or electronically-controlled suspension) must be approved by SEAT and bear the **e** mark (the European Union's authorisation symbol).

If any **additional electrical components** are fitted which do not serve to control the vehicle itself (e.g. refrigerator box, laptop or ventilator fan), these must bear the **CE** mark (European Union manufacturer conformity declaration).



WARNING

Accessories, for example telephone holders or cup holders, should never be fitted on the covers, or within the working range, of the airbags. Otherwise, there is a danger of injury if the airbag is triggered in an accident. ■

Technical modifications

Modifications must always be carried out according to our specifications.

Unauthorised modifications to the electronic components or software in the vehicle may cause malfunctions. Due to the way the electronic components are linked together in networks, other indirect systems may be affected by the faults. This can seriously impair safety, lead to excessive wear of components, and also invalidate your vehicle registration documents.

SEAT Technical Services cannot be held liable for any damage caused by modifications and/or work incorrectly performed.

For this reason, we recommend having all work performed by a SEAT Technical Service using **SEAT Original Spare Parts®**. ▶

**WARNING**

Any type of work or modification performed incorrectly on your vehicle can lead to malfunctions and can cause accidents. ■

Roof aerial*

The vehicle may be fitted with a foldable* and anti-theft* aerial that may be positioned parallel to the roof.

To fold down

Unscrew the rod, position parallel to the roof and tighten once again.

To return to working position

Continue in the reverse order to the previous instruction.

**CAUTION**

If an automatic car wash tunnel is used, before entering the tunnel, put the aerial down parallel to the roof and do not tighten to avoid damage. ■

Mobile phones and two-way radios

First consult your Technical Service if you wish to use a mobile telephone or a two-way radio with a transmitting power output in excess of 10 watts. Here you will receive information concerning the technical possibilities for retrofitting this equipment.

Mobile telephones and two-way radios should be only fitted by a specialised workshop, for example a SEAT dealership.

**WARNING**

- Always concentrate primarily on driving. If you are distracted while driving you could have an accident.
- Never attach the telephone mountings to the surfaces covering the airbag units or within the range of the airbags. There is a high danger of injury if the airbag is triggered.

**Note**

Please observe the operating instructions of your mobile telephone/two-way radio. ■

Checking and refilling levels

Refuelling

The tank flap is released manually. The tank holds approximately 55 litres.

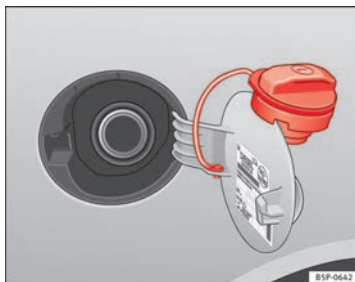

Fig. 156 Tank flap open

Opening the fuel tank cap

- Lift the lid.
- Hold the cap firmly with one hand, then insert the key into the lock and rotate 180° to the left.
- Unscrew the cap, turning it anticlockwise.

Closing the fuel tank cap

- Screw the tank cap to the right, until the point of feeling a “click”.

- Turn the key in the lock, without releasing the cap, clockwise through 180°.
- Remove the key and close the flap until it clicks into place. The tank cap is secured with an anti-loss attachment

The tank flap is at the rear of the vehicle on the right.

If the automatic filler nozzle is operated correctly, it will switch itself off as soon as the fuel tank is “full”. Never attempt to fill beyond this point, as this will fill the expansion chamber. Fuel may leak out if ambient conditions are warm.

The correct fuel grade for your vehicle is given on a sticker on the inside of the fuel tank flap. Here you will find further information on fuel. ▶

 **WARNING**

- Fuel is highly flammable and can cause serious burns and other injuries.
 - Never smoke or use an open flame when filling the fuel tank of the vehicle, or a spare fuel canister, with fuel. This is an explosion hazard.
 - Follow legal requirements for the use of spare fuel canisters.
 - For safety reasons we do not recommend carrying a spare fuel canister in the vehicle. The canister could be damaged in an accident and leak.
- If, in exceptional circumstances, you have to carry a spare fuel canister, please observe the following points:
 - Never fill the spare fuel canister inside the vehicle or on it. An electrostatic charge could build up during filling, causing the fuel fumes to ignite. This could cause an explosion. Always place the canister on the ground to fill it.
 - Insert the fuel nozzle into the mouth of the canister as far as possible.
 - If the spare fuel canister is made of metal, the filling nozzle must be in contact with the canister during filling. This helps prevent an electrostatic charge building up.
 - Never spill fuel in the vehicle or in the luggage compartment. Fuel vapours are explosive. Danger of death.

 **CAUTION**

- Fuel spills should be removed from the paintwork immediately.
- Never run the tank completely dry. An irregular fuel supply could cause misfiring. As a result, unburnt fuel could enter the catalytic converter and cause damage.

**For the sake of the environment**

Do not try to put in more fuel after the automatic filler nozzle has switched off; this may cause the fuel to overflow if it becomes warm. ■

LPG system*

Refuelling with LPG

The LPG filler neck is behind the fuel cap, next to the petrol filler neck.

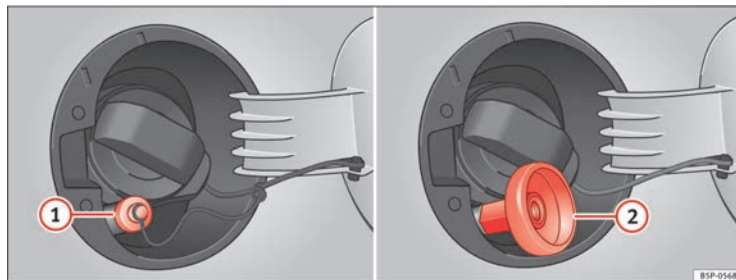

Fig. 157 Fuel tank open with LPG filler neck and adapter.

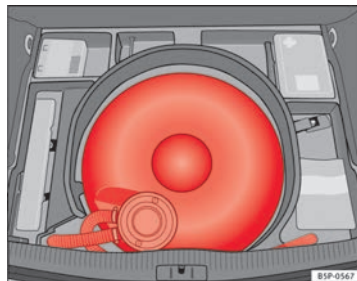

Fig. 158 LPG tank in spare wheel well

Refuelling with LPG

- **Before** refuelling, stop the engine and switch off the ignition.
- Open the fuel tank flap.
- **Before** refuelling, please read the instructions on the pump.
- Unscrew the cap of the gas filler neck ①.
- Screw the required adapter ② on the gas filler neck ①.
- Refuel as indicated in the instructions on the pump.
- Unscrew the adapter ②.

- Screw on the cap of the gas filler neck ①.
- Close the fuel tank flap.

When the hose is removed from the tank, a small amount of LPG may spill out ⇒ ⚠.

The LPG tank ⇒ Fig. 158 in the spare wheel well has a capacity of 39 litres. If the outside temperatures are very low, it may not be possible to completely fill the LPG tank.

Pump attachments

There are a variety of types of LPG pump, and the methods of use may vary. Therefore, let the pump operator fill the tank when refuelling for the first time or fill from another pump.

Noises when refuelling with LPG

When refuelling with LPG, noises may be heard. These noises are insignificant.



WARNING

Failure to refuel or handle LPG in the correct way could result in a fire, cause an explosion or lead to injuries.

- LPG is a highly explosive and inflammable substance. It may cause severe burns and other injury.
- Switch off the engine before refuelling.
- Always switch off mobile phones and any other radiophony appliances, as electromagnetic waves may produce sparks and cause a fire.
- Do not remain in the vehicle while refuelling. If it is absolutely necessary to enter the vehicle, close the door and touch a metal surface before touching the attachment again. This will prevent the generation of static electricity and any possible fires while refuelling.



WARNING (Continued)

- Small quantities of LPG may leak out after refuelling. If LPG comes into contact with skin, there is a risk of freezing.
- Do not smoke and always keep bare flames away from the tank during refuelling. Failure to do so may lead to an explosion.

Adapter for the liquid petroleum gas (LPG) filler neck

An adapter is required due to the existence of a range of pumps with different nozzles.

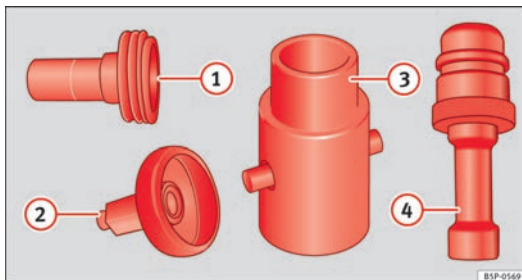

Fig. 159 General table of LPG filler neck adapters.

- ① ACME adapter (adapter for Europe)
- ② Dish Coupling Adapter (adapter for Italy)
- ③ Bayonet adapter
- ④ EURO adapter (adapter for Spain)

The supply includes the adapter for the country in question, the ACME ①, the Dish Coupling ②, the bayonet ③ or the EURO adapter ④.

The filler systems and corresponding adapters vary according to country. As petrol stations abroad do not always have the necessary adapters for your LPG system, we recommend you purchase the appropriate adapter before travelling abroad. Check that the adapters are suited to your filling system.

Note

The four most common types of adapter in Europe are the ACME adapter ①, the Dish Coupling adapter ②, the bayonet adapter ③ and the EURO adapter ④. On the whole, we recommend you carry all four adapters in your vehicle, as some countries use more than one type of filling system. The introduction of a single system (Euro nozzle) throughout Europe is being studied. ■

LPG fuel

LPG is an alternative vehicle fuel and is a blend of propane and butane.

The success of LPG is due to the strict regulations concerning exhaust gas emissions. Compared to other fossil fuels, LPG is characterised by its reduced emissions.

LPG quality and consumption

Quality requirements for LPG are regulated for all Europe in DIN EN 589 and permit the use of LPG throughout Europe.

A difference is drawn between winter gas and summer gas. Winter gas has a higher proportion of propane gas. As a result, the driving range of winter gas may be lower (due to increased consumption) than that of summer gas.

LPG supplier network

The number of LPG pumps is constantly increasing.

Lists of existing LPG pumps may be found on Internet. ■

LPG safety

A series of collision tests performed on this vehicle while running with LPG have confirmed its high level of safety. ►

The safety of the LPG system guarantees operation without risk. The following safety measures have been adopted:

- The LPG tank has a solenoid valve which closes automatically when the engine is switched off (ignition off) or when running on petrol.
- A solenoid type main valve disconnects the supply of gas to the engine compartment when the engine is switched off or running on petrol.
- A safety valve in the LPG tank with pipes to the outside prevents the gas from entering the vehicle interior.
- All anchorage points and materials have been designed to ensure the maximum possible levels of safety.

The condition of the LPG system should be checked regularly to guarantee safe driving conditions ⇒ ⚠. These checks are included in the Maintenance Programme.



WARNING

- If there is a smell of gas or a suspected leak, stop the vehicle immediately and switch off the ignition. Open the doors to ventilate the vehicle. Do not carry on driving! Take the vehicle to a specialised workshop and have the fault repaired.
- Immediately extinguish any cigarettes and remove from the vehicle any objects which might produce a spark or cause a fire, and switch off immediately if gas is smelt or a leak is detected.
- LPG tanks are subject to pressure and must be checked regularly. The owner of the vehicle must check that these services are performed correctly.
- When parking the vehicle in a closed area (for example in a garage), make sure that there is adequate ventilation, either natural or mechanical, to neutralise the LPG in the event of a leak.



Note

For any fault in the LPG system, please refer to the SEAT web page, which lists the workshops authorised to repair these faults. ■

Petrol

Petrol types

The recommended fuel types are listed on a sticker inside the fuel tank flap.

Only **unleaded petrol conforming to standard DIN EN 228** may be used for vehicles with catalytic converters (EN = “European Standard”).

Fuel types are differentiated by the **octane rating**, e.g: 91, 95, 98 RON (RON = “Research Octane Number”, unit for determining the knock resistance of petrol). You may use petrol with a higher octane number than the one recommended for your engine. However, this has no advantage in terms of fuel consumption and engine power.

The correct fuel type for your vehicle is given in the technical table for the engine, in the Technical Data section.



CAUTION

- Petrol with standard EN 228 may be mixed with small quantities of ethanol. However, bioethanol fuels available at commercial establishments with reference E50 or E85, which contain a high percentage of ethanol, may not be used, as they will damage the fuel system.
- Even one tankful of leaded fuel would permanently impair the efficiency of the catalytic converter.
- High engine speed and full throttle can damage the engine when using petrol with an octane rating lower than the correct grade for the engine.



For the sake of the environment

Just one full tank of leaded fuel would seriously impair the efficiency of the catalytic converter. ■

Petrol additives

Petrol additives improve the quality of the petrol.

The quality of the petrol influences the performance, power and life of the engine. For this reason, you should use good quality petrol containing additives. These additives will help to prevent corrosion, keep the fuel system clean and prevent deposits from building up in the engine.

If good quality petrol with additives is not available or engine problems occur, the required additives must be added during refuelling. ■

Diesel

Diesel*

Diesel fuel must conform to DIN EN 590 (EN = "European Standard"). It must have a cetane number (CN) of at least 51. The cetane number indicates the ignition quality of the diesel fuel.

Notes on refuelling ⇒ page 226.

Biodiesel*



CAUTION

- Your vehicle is **not** designed to use biodiesel fuel. **Never, under any circumstances** refuel with biodiesel. The use of biodiesel fuel could damage the engine and the fuel system. The addition of biodiesel to diesel fuel by the diesel manufacturer in accordance with standard EN 590 or DIN 51628 is authorised and will not cause damage to the engine or the fuel system.
- The diesel engine has been designed to be used exclusively with diesel fuel conforming to standard EN 590. **Never** refuel or use petrol, kerosene, fuel oil or any other type of fuel. If you accidentally fill up the vehicle with the wrong type of fuel, do not start the engine. Seek assistance from specialised personnel. The composition of these fuels may severely damage the fuel system and the engine. ■

Winter driving

Diesel can thicken in winter.

Winter-grade diesel

■ When using "summer-grade diesel fuel", difficulties may be experienced at temperatures below 0 °C because the fuel thickens due to wax separation. Therefore, "winter-grade diesel fuel" is available in some countries during the cold months. It can be used at temperatures as low as -22 °C.

In countries with different climatic conditions the diesel fuel generally sold has different temperature characteristics. Check with the Technical Services or filling stations in the country concerned regarding the type of diesel fuels available.

Filter pre-heater

Your vehicle is fitted with a fuel filter glow plug system, making it well equipped for operation in winter. This ensures that the fuel system remains ►

operational to approx. -24 °C, provided you use winter-grade diesel which is safe to -15 °C.

However, if the fuel has waxed to such an extent that the engine will not start at temperatures of under -24 °C, simply place the vehicle in a warm place for a while.



CAUTION

Do not mix fuel additives (thinners or similar products) with diesel fuel. ■

Working in the engine compartment

Safety instructions on working in the engine compartment

Any work carried out in the engine compartment or on the engine must be carried out cautiously.

Before starting any work on the engine or in the engine compartment:

1. Switch off the engine and remove the key from the ignition.
2. Apply the handbrake.
3. Move the gear lever to neutral or the selector lever to position P.
4. Wait for the engine to cool down.
5. Keep children away from the vehicle.
6. Raise the bonnet ⇒ page 235.

You should not do any work in the engine compartment unless you know exactly how to carry out the jobs and have the correct tools! Have the work carried out by a specialised workshop if you are uncertain.

All service fluids and consumables, e.g. coolant, engine oil, spark plugs and batteries, are under constant development. SEAT provides a constant flow of information to the Technical Services concerning modifications. For this reason, we recommend you to have service fluids and consumables replaced by a Technical Service. Please observe the relevant instructions ⇒ page 224. The engine compartment of the vehicle is a hazardous area. ⇒ ⚠.



WARNING

All work on the engine or in the engine compartment, e.g. checking and refilling fluids, involves the danger of injury and scalding as well as the risk of accident or fire.

- Never open the bonnet if you see steam, smoke or coolant escaping from the engine compartment. Otherwise, there is a risk of sustaining burns. Wait until no more steam or coolant is emitted, then allow the engine to cool before carefully opening the bonnet.
- Switch off the engine and remove the key from the ignition.
- Apply the handbrake and move the gear lever to neutral or selector lever to position P.
- Keep children away from the vehicle.
- Never touch hot engine parts. There is a risk of burns.
- Never spill liquids on a hot engine or on a hot exhaust gas system. This is a fire hazard.
- Avoid causing short-circuits in the electrical system, particularly at the points where the jump leads are attached ⇒ page 282. The battery could explode. ▶

 **WARNING (Continued)**

- Never touch the radiator fan. It is temperature controlled and could start automatically, even when the engine has been switched off and the key removed from the ignition!
- Do not unscrew the cap on the coolant expansion tank when the engine is hot. If the coolant is hot, the cooling system will be pressurised!
- Protect face, hands and arms by covering the cap with a large, thick cloth to protect against escaping coolant and steam.
- Always make sure you have not left any objects, such as cleaning cloths and tools, in the engine compartment.
- If you have to work underneath the vehicle, you must use suitable stands additionally to support the vehicle, there is a risk of accident! A hydraulic jack is insufficient for securing the vehicle and there is a risk of injury.
- If any work has to be performed when the engine is started or with the engine running, there is an additional, potentially fatal, safety risk from the rotating parts, such as the drive belts, alternator, radiator fan, etc., and from the high-voltage ignition system. You should also observe the following points:
 - Never touch the electrical wiring of the ignition system.
 - Ensure that jewellery, loose clothing and long hair do not get trapped in rotating engine parts. Danger of death. Before starting any work remove jewellery, tie back and cover hair, and wear tight-fitting clothes.
 - Never accelerate with a gear engaged without taking the necessary precautions. The vehicle could move, even if the handbrake is applied. Danger of death.
- If work has to be carried out on the fuel system or on electrical components, you must observe the following safety notes in addition to the above warnings:
 - Always disconnect the battery from the on-board network. The vehicle must be unlocked when this is done, otherwise the alarm will be triggered.
 - Do not smoke.

 **WARNING (Continued)**

- Never work near naked flames.
- Always have a fire extinguisher on hand.

**CAUTION**

When topping up service fluids, make sure not to mistake them. Using the wrong fluids could cause serious malfunctions and engine damage!

**For the sake of the environment**

Service fluids leaks are harmful to the environment. For this reason you should make regular checks on the ground underneath your vehicle. If you find spots of oil or other fluids, have your vehicle inspected in a specialised workshop. ■

Opening the bonnet

The bonnet is released from inside the vehicle.

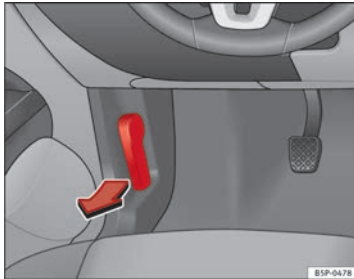

Fig. 160 Detail of footwell area on driver side: lever for unlocking the bonnet.

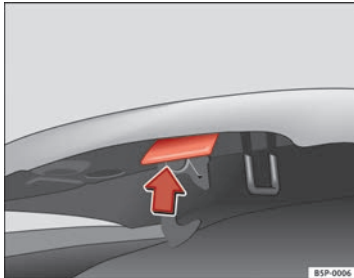

Fig. 161 Arrester hook for bonnet.

Before opening the bonnet ensure that the windscreen wipers are in rest position.

- To release the bonnet, pull the lever under the dash panel ⇒ Fig. 160 in the direction indicated (arrow). The bonnet will be released by a spring action ⇒ ⚠.
- Lift the bonnet using the release lever (arrow) and open the bonnet.
- Release the bonnet stay and secure it in fixture designed for this in the bonnet.

⚠ WARNING

Hot coolant can scald!

- Never open the bonnet if you see steam, smoke or coolant escaping from the engine compartment.
- Wait until no more steam, smoke or coolant is emitted from the bonnet, then carefully open the bonnet.
- When working in the engine compartment, always observe the safety warnings ⇒ page 233.

Closing the bonnet

- Raise the bonnet slightly
- Release the bonnet stay and replace it in its support.
- At a height of about 30 cm let it fall so it is locked.

If the bonnet does not close, do not press downwards. Open it once more and let it fall as before. ▶

**WARNING**

If the bonnet is not closed properly, it could open while you are driving and completely obscure your view of the road. Risk of accident.

- After closing the bonnet, always check that it is properly secured. The bonnet must be flush with the surrounding body panels.
- If you notice that the bonnet latch is not secured when the vehicle is moving, stop the vehicle immediately and close the bonnet properly. Risk of accident.

Engine oil

General notes

The engine comes with a special, multi-grade oil that can be used all year round.

Because the use of high-quality oil is essential for the correct operation of the engine and its long useful life, when topping up or changing oil, use only those oils that comply with VW standards.

The specifications (VW standards) set out in the following page should appear on the container of the service oil; when the container displays the specific standards for petrol and diesel engines together, it means that the oil can be used for both types of engines.

We recommend that the oil change, indicated in the Maintenance Programme, be performed by a Technical Service or a specialised workshop.

The correct oil specifications for your engine are listed in the ⇒ page 237, Oil properties.

Service intervals

Service intervals can be flexible (LongLife service) or fixed (dependent on time/distance travelled).

If the PR code that appears on the back of the “Maintenance Programme” booklet is PR Q16, this means that your vehicle has the LongLife service programmed. If it lists the codes Q11, Q12, Q13, Q14 or Q17, the interval service is dependent on time/distance travelled.

Flexible service intervals (LongLife service intervals*)

Special oils and processes have been developed which, depending on the characteristics and individual driving profiles, enable the extension of the oil change service (LongLife service intervals).

Because this oil is essential for extending the service intervals, it **must only** be used observing the following indications:

- Avoid mixing it with oil for fixed service intervals.
- Only in exceptional circumstances, if the engine oil level is too low ⇒ page 237 and LongLife oil is not available, it is permitted to top up (once) with oil for **fixed service intervals** ⇒ page 237 (up to a maximum of 0.5 litres).

Fixed service intervals*

If your vehicle does not have the “LongLife service interval” or it has been disabled (by request), you may use oils for **fixed service intervals**, which also appear in ⇒ page 237, Oil properties. In this case, your vehicle must be serviced after a fixed interval of 1 year/15 000 km (10 000 miles) (whatever comes first) ⇒ Booklet Maintenance Programme.

- In exceptional circumstances, if the engine oil level is too low ⇒ page 237 and you cannot obtain the oil specified for your vehicle, you can put in a small quantity of oil conforming to the specification ACEA A2 or ACEA A3 (petrol engines) or ACEA B3 or ACEA B4 (diesel engines) (up to 0.5 l).

Vehicles with diesel particulate filter*

The “Maintenance Programme” states whether your vehicle is fitted with a diesel particulate filter.

Only VW 507 00 engine oil, with reduced ash formation, may be used in diesel engines equipped with particulate filter. Using other types of oil will cause a higher soot concentration and reduce the life of the DPF. Therefore:

- Avoid mixing this oil with other engine oils.
- Only in exceptional circumstances, if the engine oil level is too low ⇒ page 237 and you cannot obtain the oil specified for your vehicle, you can use a small quantity of oil (once) conforming to the VW 506 00, VW 506 01, VW 505 00, VW 505 01 or ACEA B3/ACEA B4 specification. (up to 0.5 l).

Oil properties

Engine type	Specification
Petrol without flexible service interval	VW 502 00/VW 504 00
Petrol with flexible service interval (LongLife)	VW 504 00
Diesel. Engines without Particulate filter (DPF)	VW 505 01/VW 506 01/VW 507 00
Diesel. Particulate Filter Engines (DPF). With or without flexible service interval (with and without LongLife) ^{a)}	VW 507 00

^{a)} Only use recommended oils, otherwise you may damage the engine.

Engine oil additives

No type of additive should be mixed with the engine oil. The deterioration caused by these additives is not covered by the warranty.



Note

Before a long trip, we recommend finding an engine oil that conforms to the corresponding VW specifications and recommend keeping it in the vehicle. This way, the correct engine oil will always be available for a top-up if needed.

Checking the engine oil level

The engine oil dipstick indicates the level of the oil.

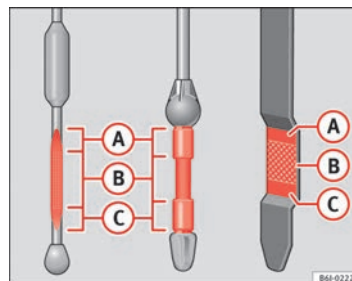

Fig. 162 Engine oil dipstick

Checking oil level

- Park the vehicle in a horizontal position.

- Briefly run the engine at idle speed until the operating temperature is reached and then stop.
- Wait two minutes.
- Pull out the dipstick. Wipe the dipstick with a clean cloth and insert it again, pushing it in as far as it will go.
- Then pull it out once more and check the oil level ⇒ Fig. 162. Top up with engine oil if necessary.

Oil level in area A

- Do **not** add oil ⇒ ④.

Oil level in area B

- You **can** add oil, but keep the level in this zone.

Oil level in area C

- Oil **must** be added. **Afterwards**, the oil level should be in the lined area **B**.

Depending on how you drive and the conditions in which the vehicle is used, oil consumption can be up to 0.5 l/1000 km. Oil consumption is likely to be higher for the first 5000 km (3000 miles). For this reason the engine oil level must be checked at regular intervals, preferably when filling the tank and before a journey.

⚠ WARNING

Any work carried out in the engine compartment or on the engine must be carried out cautiously.

- **When working in the engine compartment, always observe the safety warnings ⇒ page 233.**

⚠ CAUTION

If the oil level is above the area **A** do not start the engine. This could result in damage to the engine and catalytic converter. Contact a Technical Service. ■

Topping up engine oil 🛢

Top up gradually with small quantities of engine oil.



Fig. 163 In the engine compartment: Engine oil filter cap

Before opening the bonnet, read and observe the warnings ⇒ ⚠ in Safety instructions on working in the engine compartment on page 233.

- Unscrew cap from engine oil filler opening ⇒ Fig. 163.
- Top-up oil in small amounts, using the correct oil. ▶

- To avoid over-filling with engine oil, you should top-up using small quantities, wait a while and check the oil level before adding any more oil.
- As soon as the oil level is in area **B**, carefully close the cap.

The position of the oil filler opening is shown in the corresponding engine compartment illustration ⇒ page 291.

Engine oil specification ⇒ page 236.

WARNING

Oil is highly inflammable! Ensure that no oil comes into contact with hot engine components when topping up.

CAUTION

If the oil level is above the area **A** do not start the engine. This could result in damage to the engine and catalytic converter. Contact a specialised workshop.

For the sake of the environment

The oil level must never be above area **A**. Otherwise oil can be drawn in through the crankcase breather and escape into the atmosphere via the exhaust system.

Changing engine oil

The engine oil must be changed at the intervals given in the service schedule.

We recommend that you have the engine oil changed by a Technical Service.

The oil change intervals are shown in the Maintenance Programme.

WARNING

Only change the engine oil yourself if you have the specialist knowledge required!

- **Before opening the bonnet, read and observe the warnings** ⇒ page 233, Safety instructions on working in the engine compartment.
- **Wait for the engine to cool down.** Hot oil may cause burn injuries.
- **Wear eye protection to avoid injuries, such as acid burns, caused by splashes of oil.**
- **When removing the oil drain plug with your fingers, keep your arm horizontal to help prevent oil from running down your arm.**
- **Wash your skin thoroughly if it comes into contact with engine oil.**
- **Engine oil is poisonous! Used oil must be stored in a safe place out of the reach of children.**

CAUTION

No additives should be used with engine oil. This could result in engine damage. Any damage caused by the use of such additives would not be covered by the factory warranty.

For the sake of the environment

- Because of the disposal problems, the necessary special tools and specialist knowledge required, we recommend that you have the engine oil and filter changed by a Technical Service.
- **Never pour oil down drains or into the ground.**
- **Use a suitable container when draining the used oil.** It must be large enough to hold all the engine oil.



Coolant

Engine coolant specifications

The engine cooling system is supplied from the factory with a specially treated mixture of water and, at least, 40 % of the additive **G 13** (TLVW 774 J). The engine coolant additive is recognisable by its purple colour. This mixture of water and additive gives the necessary frost protection down to -25 °C (-13 °F) and protects the light alloy parts of the cooling system against corrosion. It also prevents scaling and considerably raises the boiling point of the coolant.

To protect the engine cooling system, the percentage of additive must *always* be at least 40 %, even in warm climates where anti-freeze protection is not required.

If greater frost protection is required in very cold climates, the proportion of additive can be increased. However, the percentage of additive should not exceed 60 %, as this would reduce the frost protection and, in turn, decrease the cooling capacity.

When the coolant is topped up, use a mixture of **distilled water** and, at least, 40 % of the G 13 or G 12 plus-plus (TL-VW 774 G) additive (both are purple) to obtain an optimum anticorrosion protection ⇒ . The mixture of G 13 with G 12 plus (TL-VW 774 F), G 12 (red) or G 11 (green-blue) engine coolants will significantly reduce the anticorrosion protection and should, therefore be avoided ⇒ .



WARNING

If there is not enough anti-freeze in the coolant system, the engine may fail leading to serious damage.

- Please make sure that the percentage of additive is correct with respect to the lowest expected ambient temperature in the zone in which the vehicle is to be used.
- When the outside temperature is very low, the coolant could freeze and the vehicle would be immobilised. In this case, the heating would not work either and inadequately dressed passengers could die of cold.



CAUTION

The original additives should never be mixed with coolants which are not approved by SEAT. Otherwise, you run the risk of causing severe damage to the engine and the engine cooling system.

- If the fluid in the expansion tank is not purple but is, for example, brown, this indicates that the G 13 additive has been mixed with an inadequate coolant. The coolant must be changed as soon as possible if this is the case! This could result in serious faults and engine damage.



For the sake of the environment

Coolants and additives can contaminate the environment. If any fluids are spilled, they should be collected and correctly disposed of, with respect to the environment. ■

Checking the coolant level and topping up

The correct coolant level is important for fault-free functioning of the engine cooling system.



Fig. 164 In the engine compartment: Coolant expansion tank cap

Before opening the bonnet, read and observe the warnings ⇒  in Safety instructions on working in the engine compartment on page 233.

Opening the coolant expansion tank

- Switch off the engine and allow it to cool.
- To prevent scalding, cover the cap on the coolant expansion tank with a thick cloth and carefully unscrew the cap ⇒ .

Checking coolant level

- Look into the open coolant expansion tank and read off the coolant level.
- If the level is below the “MIN” mark, top up with coolant.

Topping up coolant

- Only use **new** coolant liquid.
- Do not fill above the “MAX” mark.

Closing the coolant expansion tank

- Screw the cap on again *tightly*.

The position of the coolant expansion reservoir is shown in the corresponding engine compartment illustration ⇒ page 291.

Make sure that the coolant meets the required specifications ⇒ page 240. Do not use a different type of additive if additive G12+ is not available. In this case use only water and bring the coolant concentration back up to the correct level as soon as possible by putting in the specified additive ⇒ page 240.

Always top up with *new* coolant.

Do not fill above the “MAX” mark. Otherwise the excess coolant will be forced out of the cooling system when the engine is hot.

The coolant additive G12+ (dyed purple) may be mixed with G12 (dyed red) and also with G11.

WARNING

Any work carried out in the engine compartment or on the engine must be carried out cautiously.

- When working in the engine compartment, always observe the safety warnings ⇒ page 233.
- When the engine is warm or hot, the cooling system is pressurised! Do not unscrew the cap on the coolant expansion tank when the engine is hot. This is a burn injury risk.

⚠ CAUTION

- When mixed with other additives the colour of G12 will change to brown. If this occurs you should have the coolant changed immediately. Failure to do so will result in engine damage!
- If a lot of coolant fluid has been lost, wait for the engine to *cool down* before putting in cold coolant. This avoids damaging the engine. Large coolant losses are an indication of leaks in the cooling system. See a specialised workshop immediately and have the cooling system checked. Otherwise, there is a risk of engine damage.

Washer fluid and windscreen wiper blades

Topping up washer fluid 🚿

The water for cleaning the windscreen should always be mixed with washer fluid.



Fig. 165 In the engine compartment: Cap of windscreen washer fluid reservoir.

The **windscreen washer** and the **headlight washers** are supplied with fluid from the windscreen washer fluid container in the engine compartment.

The reservoir is located on the right-hand side of the engine compartment.

Plain water is not enough to clean the windscreen and headlights. We recommend that you always add a product to the windscreen washer fluid. Approved windscreen cleaning products exist on the market with high detergent and anti-freeze properties, these may be added all-year-round. Please follow the dilution instructions on the packaging.

⚠ WARNING

Any work carried out in the engine compartment or on the engine must be carried out cautiously.

- **When working in the engine compartment, always observe the safety warnings ⇒ page 233.**

⚠ CAUTION

- Never put radiator anti-freeze or other additives into the windscreen washer fluid.
- Always use approved windscreen cleansing products diluted as per instructions. If you use other washer fluids or soap solutions, the tiny holes in the fan-shaped nozzles could become blocked.

Changing windscreen wiper blades

If the windscreen wiper blades are in perfect condition, you will benefit from an improved visibility. Damaged wiper blades should be replaced immediately.

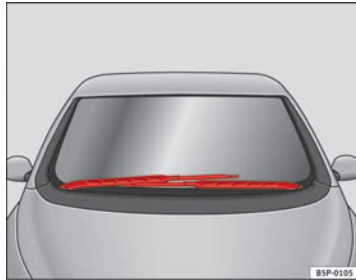

Fig. 166 Windscreen wipers in the service position

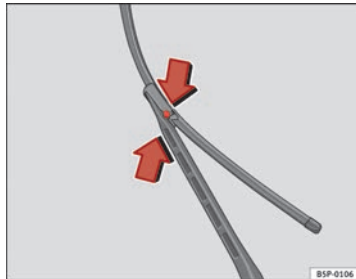

Fig. 167 Changing the front wiper blades

To change the blades it is necessary to change the rest position of the wipers to the service position.

Service position (For changing wiper blades)

- Ensure that the wiper blades are not frozen.
- Turn ignition on and off and then (before approx. 8 seconds have elapsed), move the windscreen wiper lever to the intermittent wipe position. The windscreen wipers will move to the service position.

Changing the windscreen wiper blades

- Lift the wiper arm away from the windscreen.
- Push the side buttons, free the blade and pull in the direction of the arrow → Fig. 167

Fitting the wiper blade

- Insert a blade of identical length and design into the wiper arm.
- Slide the blade until it clicks into position.
- Push the wiper arms back against the windscreen.

If the **windscreen wipers smear**, they should be replaced if they are damaged, or cleaned if they are soiled.

If this does not produce the desired results, the setting angle of the windscreen wiper arms might be incorrect. They should be checked by a specialised workshop and corrected if necessary. ▶

! WARNING

Do not drive unless you have good visibility through all windows!

- Clean the windscreen wiper blades and all windows regularly.
- The wiper blades should be changed once or twice a year.

! CAUTION

- Damaged or dirty windscreen wipers could scratch the windscreen.
- Never use fuel, nail varnish remover, paint thinner or similar products to clean the windows. This could damage the windscreen wiper blades.
- Never move the windscreen wiper or windscreen wiper arm manually. This could cause damage.
- Do not pull the windscreen wipers forward unless they are in the service position. Otherwise the bonnet could be damaged.

i Note

- The windscreen wiper arms can be moved to the service position only when the bonnet is properly closed. ■

Changing the rear wiper blade

A good rear wiper blade is essential for clear rear vision. Damaged wiper blades should be replaced immediately.

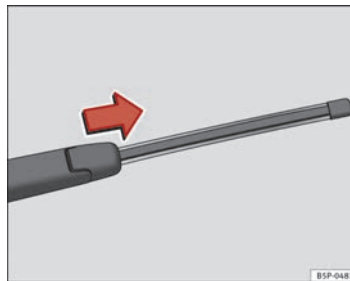

Fig. 168 Removing the rear window wiper blade

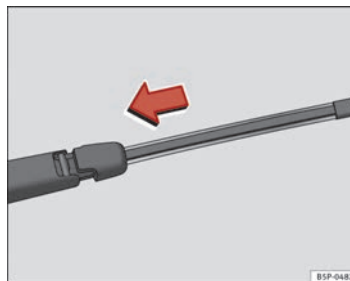

Fig. 169 Fitting the rear window wiper blade ▶

Removing the wiper blade

- Lift the wiper arm away from the glass ⇒ Fig. 168
- Slide the blade adapter in the direction of the arrow and remove the blade ⇒ Fig. 168.

Fitting the wiper blade

- With one hand, hold the top end of the wiper arm.
- Place the blade as shown in the ⇒ Fig. 169 and slide the adapter along until it engages.

Check the condition of the wiper blade regularly. Change as required.

If the **windscreen wiper scrapes**, it should be replaced if damaged, or cleaned if soiled.

If this is not sufficient, refer to a specialised workshop.

WARNING

Do not drive unless you have good visibility through all windows!

- Clean the windscreen wiper blades and all windows regularly.
- The wiper blades should be changed once or twice a year.

CAUTION

- A damaged or dirty window wiper could scratch the rear window.
- Never use fuel, nail varnish remover, paint thinner or similar products to clean the window.
- Never move the windscreen wiper by hand. This could cause damage. ■

Brake fluid

Checking the brake fluid level

The brake fluid is checked at the intervals given in the service schedule.



Fig. 170 In the engine compartment: Brake fluid reservoir cover

- Read off the fluid level at the transparent brake fluid reservoir. It should always be between the “MIN” and “MAX” marks.

The position of the brake fluid reservoir is shown in the corresponding engine compartment illustration ⇒ page 291. The brake fluid reservoir has a black and yellow cap.

The brake fluid level drops slightly when the vehicle is being used as the brake pads are automatically adjusted as they wear.

However, if the level goes down noticeably in a short time, or drops below the “MIN” mark, there may be a leak in the brake system. A display on the instrument panel will warn you if the brake fluid level is too low ⇒ page 77. ▶

**WARNING**

Before opening the bonnet to check the brake fluid level, read and observe the warnings ⇒ page 233.

Changing the brake fluid

The Maintenance Programme indicates the brake fluid change intervals.

We recommend that you have the brake fluid changed by a Technical Service.

Before opening the bonnet, please read and follow the warnings ⇒  in Safety instructions on working in the engine compartment on page 233 in section "Safety notes for working in the engine compartment".

Brake fluid absorbs moisture. In the course of time, it will absorb water from the ambient air. If the water content in the brake fluid is too high, the brake system could corrode. This also considerably reduces the boiling point of the brake fluid. Heavy use of the brakes may then cause a vapour lock which could impair the braking effect.

Be sure to always use the correct brake fluid. Only use brake fluid that expressly meets VW 501 14 standards.

You can buy VW 501 14 standard brake fluid in a SEAT dealership or SEAT Official Service. If none is available, use only high quality brake fluid that meets DIN ISO 4925 CLASS 4 standards, or USA Standards FMVSS 116 DOT 4.

Using any other kind of brake fluid or one that is not of a high quality may affect operation of the brake system and reduce its effectiveness. Never use a brake fluid if the container does not state that it complies with VW 501 14, DIN ISO 4925 CLASS 4 standards, or USA standards FMVSS 116 DOT 4.

**WARNING**

Brake fluid is poisonous. Old brake fluid impairs the braking effect.

- Before opening the bonnet to check the brake fluid level, read and observe the warnings ⇒ page 233.
- Brake fluid should be stored in the closed original container in a safe place out of reach of children. There is a toxic risk.
- Complete the brake fluid change according to the Maintenance Programme. Heavy use of the brakes may cause a vapour lock if the brake fluid is left in the brake system for too long. This would seriously affect the effectiveness of the brakes and the safety of the vehicle. This may cause an accident.

**CAUTION**





Brake fluid damages the vehicle paintwork. Wipe off any brake fluid from the paintwork immediately.

**For the sake of the environment**

The brake pads and brake fluid must be collected and disposed of according to the applicable regulations. The SEAT Technical Service network has the necessary equipment and qualified personnel for collecting and disposing of this waste material.

Vehicle battery

Warnings on handling the battery

	Wear eye protection
	Battery acid is extremely corrosive. Wear protective gloves and eye protection!
	Fires, sparks, open flames and smoking are prohibited!
	A highly explosive mixture of gases is released when the battery is under charge.
	Keep children away from acid and batteries!

 **WARNING**

Always be aware of the danger of injury and chemical burns as well as the risk of accident or fire when working on the battery and the electrical system:

- Wear eye protection. Protect your eyes, skin and clothing from acid and particles containing lead.
- Battery acid is extremely corrosive. Wear protective gloves and eye protection. Do not tilt the batteries. This could spill acid through the vents. Rinse battery acid from eyes immediately for several minutes with clear water. Then seek medical care immediately. Neutralise any acid splashes on the skin or clothing with a soapy solution, and rinse off with plenty of water. If acid is swallowed by mistake, consult a doctor immediately.

 **WARNING (Continued)**



- Fires, sparks, open flames and smoking are prohibited. When handling cables and electrical equipment, avoid causing sparks and electrostatic charge. Never short the battery terminals. High-energy sparks can cause injury.
- A highly explosive mixture of gases is released when the battery is under charge. The batteries should be charged in a well-ventilated room only.
- Keep children away from acid and batteries.
- Before working on the electrical system, you must switch off the engine, the ignition and all consumers. The negative cable on the battery must be disconnected. When a light bulb is changed, you need only switch off the light.
- Deactivate the anti-theft alarm by unlocking the vehicle before you disconnect the battery! The alarm will otherwise be triggered.
- When disconnecting the battery from the vehicle on-board network, disconnect first the negative cable and then the positive cable.
- Switch off all electrical consumers before reconnecting the battery. Reconnect first the positive cable and then the negative cable. Never reverse the polarity of the connections. This could cause an electrical fire.
- Never charge a frozen battery, or one which has thawed. This could result in explosions and chemical burns. Always replace a battery which has frozen. A flat battery can freeze at temperatures around 0 °C.
- Ensure that the vent hose is always connected to the battery.
- Never use a defective battery. This could cause an explosion. Replace a damaged battery immediately.

**CAUTION**

- Never disconnect the battery if the ignition is switched on or if the engine is running. This could damage the electrical system or electronic components.
- Do not expose the battery to direct sunlight over a long period of time, as the intense ultraviolet radiation can damage the battery housing.
- If the vehicle is left standing in cold conditions for a long period, protect the battery from freezing. If it freezes it will be damaged.

Checking the electrolyte level

The electrolyte level should be checked regularly in high-mileage vehicles, in hot countries and in older batteries.

- Open the engine bonnet and the battery cover ⇒  in Safety instructions on working in the engine compartment on page 233 ⇒  in Warnings on handling the battery on page 247.
- Check the colour display in the "magic eye" on the top of the battery.
- If there are air bubbles in the window, tap the window gently until they disperse.

The position of the battery is shown in the corresponding engine compartment diagram ⇒ page 291.

The "magic eye" indicator, located on the top of the battery changes colour, depending on the charge state and electrolyte level of the battery.

There are two different colours:

- Black: correct charge status.
- Transparent/clear yellow: the battery must be replaced. Contact a specialised workshop.

Charging and changing the vehicle battery

The battery is maintenance-free and is checked during the inspection service. All work on the vehicle battery requires specialist knowledge.

If you often drive short distances or if the vehicle is not driven for long periods, the battery should be checked by a specialised workshop between the scheduled services.

If the battery has discharged and you have problems starting the vehicle, the battery might be damaged. If this happens, we recommend you have the vehicle battery checked by a Technical Service where it will be re-charged or replaced.

Charging the battery

The vehicle battery should be charged by a specialised workshop only, as batteries using special technology have been installed and they must be charged in a controlled environment.

Replacing a vehicle battery

The battery has been developed to suit the conditions of its location and has special safety features.

Genuine SEAT batteries fulfil the maintenance, performance and safety specifications of your vehicle.

**WARNING**

- We recommend you use only maintenance-free or cycle free leak-proof batteries which comply with standards T 825 06 and VW 7 50 73. This standard applies as of 2001.
- Before starting any work on the batteries, you must read and observe the warnings ⇒  in Warnings on handling the battery on page 247.

**For the sake of the environment**

Batteries contain toxic substances such as sulphuric acid and lead. They must be disposed of appropriately and must not be disposed of with ordinary household waste. ■

Wheels and tyres

Wheels

General notes

Avoiding damage

- If you have to drive over a kerb or similar obstacle, drive very slowly and at a right angle.
- Keep grease, oil and fuel off the tyres.
- Inspect the tyres regularly for damage (cuts, cracks or blisters, etc.). Remove any foreign objects embedded in the treads.

Storing tyres

- When you remove the tyres, mark them in order to maintain the same direction of rotation when they are installed again.
- When removed, the wheels and/or tyres should be stored in a cool, dry and preferably dark location.
- Store tyres in a vertical position if they are not fitted on wheel rims.

New tyres

New tyres must be run in ⇒ page 202.

The tread depth of new tyres may vary, according to the type and make of tyre and the tread pattern.

Concealed damage

Damage to tyres and rims is often not readily visible. If you notice unusual vibrations or the vehicle pulling to one side, this may indicate that one of the tyres is damaged. The tyres should be checked immediately by a Technical Service.

Tyres with directional tread pattern

An arrow on the tyre sidewall indicates the direction of rotation on tyres with directional tread. Always observe the direction of rotation indicated when fitting the wheel. This guarantees optimum grip and helps to avoid aquaplaning, excessive noise and wear.



WARNING

- **New tyres do not have maximum grip during the first 500 km (300 miles). Drive particularly carefully to avoid possible accidents.**
- **Never drive with damaged tyres. This may cause an accident.**
- **If you notice unusual vibrations or if the vehicle pulls to one side when driving, stop the vehicle immediately and check the tyres for damage.**

Checking tyre pressure

The correct tyre pressure can be seen on the sticker on the inside of the fuel tank flap.

1. Read the required tyre inflation pressure from the sticker. The values refer to Summer tyres. For Winter tyres, you must add 0.2 bar to the values given on the sticker. ▶

- The tyre pressures should only be checked when the tyres are cold. The slightly raised pressures of warm tyres must not be reduced.
- Adjust the tyre pressure to the load you are carrying.

Tyre pressure

The correct tyre pressure is especially important at high speeds. The pressure should therefore be checked at least once a month and before starting a journey.

The sticker with the tyre pressure values can be found on the inside of the fuel tank flap. The tyre pressure values given are for cold tyres. Do not reduce the slightly raised pressures of warm tyres ⇒ ⚠.



WARNING

- Check the tyre pressure at least once per month. Checking the tyre pressure is very important. If the tyre pressure is too high or too low, there is an increased danger of accidents - particularly at high speeds.
- A tyre can easily burst if the pressure is too low, causing an accident!
- At continuously high speeds, a tyre with insufficient pressure flexes more. In this way it becomes too hot, and this can cause tread separation and tyre blow-out. Always observe the recommended tyre pressures.
- If the tyre pressure is too low or too high, the tyres will wear prematurely and the vehicle will not handle well. Risk of accident!



For the sake of the environment

Under-inflated tyres will increase fuel consumption. ■

Tyre pressure monitoring

The tyre pressure monitoring system constantly checks the pressure of the tyres.

The system uses the speed sensors of the ABS wheels. It operates by analysing the speed and frequency spectrum of each wheel.

For optimum performance, use genuine SEAT tyres. In addition, check and adjust tyre pressures regularly.

Whenever the tyre pressures are changed or one or more tyres are changed, the system should be Reset by pressing the SET switch on the centre console.

The system warns the driver in the event of a loss of pressure by means of symbols and messages in the instrument panel display. The system operates via the ESC ⇒ page 196.

Note that tyre pressure also depends on tyre temperature. Tyre pressure increases about 0.1 bar for each 10 °C in tyre temperature increase. The tyre heats up while the vehicle is being driven and the tyre pressure will rise accordingly. For this reason, you should only adjust the tyre pressures when they are cold (i.e. approximately at ambient temperature).

To ensure that the tyre pressure monitoring system works reliably, you should check and, if necessary, adjust the tyre pressures at regular intervals and store the correct pressures (reference values) in the system.

A tyre pressure information label is attached to the inside of the fuel tank flap. ▶

**WARNING**

- Never adjust tyre pressure when the tyres are hot. This may damage or even burst the tyres. Risk of accident!
- An insufficiently inflated tyre flexes a lot more at high speeds and causes significant heating of the tyre. Under these conditions, the tyre bead may be released or the tyre may burst. Risk of accident!

**For the sake of the environment**

Under-inflated tyres lead to increased fuel consumption and tyre wear. ■

Significant tyre pressure loss

The tyre symbol (⚠) is displayed and indicates that the tyre pressure of at least one tyre is insufficient.

- Stop the vehicle.
- Switch the engine off.
- Check the tyre(s).
- Change the wheel if necessary. ■

Tyre useful life

The useful life of tyres is dependent on tyre pressure, driving style and fitting.



Fig. 171 Tyre tread wear indicators

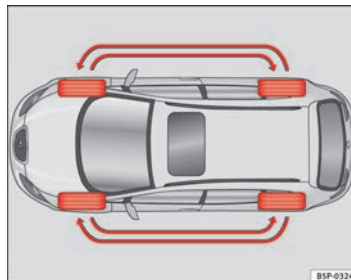

Fig. 172 Diagram for changing wheels ▶

Wear indicators

The original tyres on your vehicle have 1.6 mm high “tread wear indicators” ⇒ Fig. 171, running across the tread. Depending on the make, there will be 6 to 8 of them evenly spaced around the tyre. Markings on the tyre sidewall (for instance the letters “TWI” or other symbols) indicate the positions of the tread wear indicators. The minimum tread depth required by law is 1.6 mm (measured in the tread grooves next to the tread wear indicators). Worn tyres must be replaced. Different figures may apply in export countries ⇒ ⚠.

Tyre pressure

Incorrect tyre pressure causes premature wear and could cause tyre blow-out. For this reason, the tyre pressure should be checked at least once per month ⇒ page 250.

Driving style

Fast cornering, heavy acceleration and hard braking all increase tyre wear.

Changing wheels around

If the front tyres are worn considerably more than the rear ones it is advisable to change them around as shown ⇒ Fig. 172. The useful life of all the tyres will then be about the same time.

Wheel balance

The wheels on new vehicles are balanced. However, various factors encountered in normal driving can cause them to become unbalanced, which results in steering vibration.

Unbalanced wheels should be rebalanced, as they otherwise cause excessive wear on steering, suspension and tyres. A wheel must also be rebalanced when a new tyre is fitted.

Incorrect wheel alignment

Incorrect wheel alignment causes excessive tyre wear, impairing the safety of the vehicle. If tyres show excessive wear, you should have the wheel alignment checked by a Technical Service.



WARNING

There is a serious danger of accidents if a tyre bursts during driving!

- **The tyres must be replaced at the latest when the tread wear indicators are worn ⇒ page 253. Failure to do so could result in an accident. Worn tyres do not grip well at high speeds on wet roads. There is also a greater risk of aquaplaning.**
- **At continuously high speeds, a tyre with insufficient pressure flexes more. This causes it to overheat. This can cause tread separation and tyre blow-out. Risk of accident. Always observe the recommended tyre pressures.**
- **If tyres show excessive wear, you should have the running gear checked by a Technical Service.**
- **Keep chemicals such as oil, fuel and brake fluid away from tyres.**
- **Damaged wheels and tyres must be replaced immediately!**



For the sake of the environment

Under-inflated tyres will increase fuel consumption. ■

Run-flat tyres

Run-flat tyres allow you to continue driving even with a punctured tyre, in the majority of cases.

In vehicles that are factory-fitted with run-flat tyres¹⁾ the loss of tyre pressure is indicated on the instrument panel.

Driving with run-flat tyres (emergency running)

- Leave the ESC/ASR on (Electronic Stability Control), or switch it on ⇒ page 195.
- Continue driving carefully and slowly (80 km/h (50 mph) maximum).
- Avoid sudden manoeuvres and sharp turns.
- Avoid driving over obstacles (for example kerbs) or potholes.
- Pay attention if the ESC/ASR activates often, if smoke comes from the tyres or there is a smell of rubber, the vehicle vibrates or there are clattering noises. If any of these occur, stop the vehicle.

The run-flat tyres have a tag on the side of the tyre, with the description: “DSST”, “Eufonia”, “RFT”, “ROF”, “RSC”, “SSR” or “ZP”.

The sides of this type of tyre are reinforced. When the tyres lose air they are supported on the sides (emergency driving).

The loss of pressure in the tyre is shown on the instrument panel. You can then drive a maximum of 80 km (50 miles) and if the circumstances are favourable (for example, low load), even more.

The damaged tyre should be changed as soon as possible. The rim should be checked in a specialised workshop to detect possible damage and replace it if necessary. We recommend you contact Technical Service. If more than one tyre is being used under emergency conditions, this reduces the distance which can be travelled.

Starting driving in emergency conditions

When loss in tyre pressure is displayed on the instrument panel, this means that at least one tyre is being driven in emergency conditions ⇒ .

End of emergency operation

Do not drive on if:

- smoke is coming from one of the tyres,
- there is a smell of rubber,
- the vehicle vibrates,
- there is a rattling noise.

When is it no longer possible to continue driving even using run-flat tyres?

- If one of the tyres has been severely damaged in an accident, etc. If a tyre has been badly damaged there is a risk that parts of the tread can be thrown off and cause damage to the fuel lines, brake pipes or fuel filler.
- It is also advisable to stop driving if severe vibrations occur, or if the wheel starts overheating and gives off smoke. ►

¹⁾ Depending upon version and country.

**WARNING**

When driving in emergency conditions, the driving quality of the vehicle is considerably impaired.

- The maximum permitted speed of 80 km/h (50 mph) is subject to road and weather conditions. Please observe legal requirements when doing so.
- Avoid sharp turns and rapid manoeuvres, and brake earlier than usual.
- Avoid driving over obstacles (for example kerbs) or potholes.
- If one or more tyres are being driven in emergency conditions, the driving quality of the vehicle is impaired and there is a risk of accident.

**Note**

- The run-flat tyres do not “deflate” on losing pressure because they are supported on the reinforced sides. Therefore defects in the tyre cannot be detected with a visual inspection.
- Snow chains must not be used on front tyres used in emergency conditions.

New tyres and wheels

New tyres and wheels have to be run in.

The tyres and wheel rims are an essential part of the vehicle's design. The tyres and rims approved by SEAT are specially matched to the characteristics of the vehicle and make a major contribution to good road holding and safe handling ⇒ .

Tyres should be replaced at least in pairs and not individually (i.e. both front tyres or both rear tyres together). A knowledge of tyre designations makes it easier to choose the correct tyres. Radial tyres have the tyre designations marked on the sidewall, for example:

195/65 R15 91T

This contains the following information:

195 Tyre width in mm
 65 Height/width ratio in %
 R Tyre construction: Radial
 15 Rim diameter in inches
 91 Load rating code
 T Speed rating

The tyres could also have the following information:

- A direction of rotation symbol
- “Reinforced” denotes heavy-duty tyres.

The manufacturing date is also indicated on the tyre sidewall (possibly only on the inner side of the wheel).

“DOT ... 1103 ...” means, for example, that the tyre was produced in the 11th week of 2003.

We recommend that work on tyres and wheels be carried out by a Technical Service. They are familiar with the procedure and have the necessary special tools and spare parts as well as the proper facilities for disposing of the old tyres.

Any Technical Service has full information on the technical requirements when installing or changing tyres, wheels or wheel trims. ▶

**WARNING**

- We recommend that you use only wheels and tyres which have been approved by SEAT for your model. Failure to do so could impair vehicle handling. Risk of accident.
- Avoid running the vehicle on tyres that are more than 6 years old. If you have no alternative, you should drive slowly and with extra care at all times.
- Never use old tyres or those with an unknown history of use.
- If wheel trims are retrofitted, you must ensure that the flow of air to the brakes is not restricted. This could cause the brake system to overheat.
- All four wheels must be fitted with radial tyres of the same type, size (rolling circumference) and the same tread pattern.

**For the sake of the environment**

Old tyres must be disposed of according to the laws in the country concerned.

**Note**

- For technical reasons, it is not generally possible to use the wheels from other vehicles. This can also apply to wheels of the same model. The use of wheels or tyres which have not been approved by SEAT for use with your model may invalidate the vehicle's type approval for use on public roads.
- If the spare tyre is not the same as the tyres that are mounted on the vehicle (e.g. winter tyres) you should only use the spare tyre for a short period of time and drive with extra care. Refit the normal road wheel as soon as possible.

Wheel bolts

Wheel bolts must be tightened to the correct torque.

The design of wheel bolts is matched to the rims. If different wheel rims are fitted, the correct wheel bolts with the right length and correctly shaped bolt heads must be used. This ensures that wheels are fitted securely and that the brake system functions correctly.

In certain circumstances, you should not use wheel bolts from a different vehicle, even if it is the same model ⇒ page 224.

After the wheels have been changed, the tightening torque of the wheel bolts should be checked as soon as possible with a torque wrench ⇒ . The tightening torque for steel and alloy wheels is 120 Nm.

**WARNING**

If the wheel bolts are not tightened correctly, the wheel could become loose while driving. Risk of accident.

- The wheel bolts must be clean and turn easily. Never apply grease or oil to them.
- Use only wheel bolts which belong to the wheel.
- If the tightening torque of the wheel bolts is too low, they could loosen whilst the vehicle is in motion. Risk of accident! If the tightening torque is too high, the wheel bolts and threads can be damaged.

**CAUTION**

The prescribed tightening torque for wheel bolts for steel and alloy wheels is 120 Nm.

Winter tyres

Winter tyres will improve the vehicles handling on snow and ice.

In winter conditions winter tyres will considerably improve the vehicle's handling. The design of summer tyres (width, rubber compound, tread pattern) gives less grip on ice and snow.

Winter tyres must be inflated to a **pressure** 0.2 bar higher than the pressures specified for summer tyres (see sticker on fuel tank flap).

Winter tyres must be fitted on all four wheels.

Information on permitted **winter tyre sizes** can be found in the vehicle's registration documentation. Use only radial winter tyres. All tyre sizes listed in the vehicle documentation also apply to winter tyres.

Winter tyres lose their effectiveness when the tread is worn down to a depth of 4 mm.

The speed rating code ⇒ page 255, New tyres and wheels determines the following **speed limits** for winter tyres: ⇒ ⚠

- Q max. 160 km/h (100 mph)
- S max. 180 km/h (110 mph)
- T max. 190 km/h (120 mph)
- H max. 210 km/h (130 mph)

In some countries, vehicles which can exceed the speed rating of the fitted tyre must have an appropriate sticker in the driver's field of view. These stickers are available from your Technical Service. The legal requirements of each country must be followed.

Do not have winter tyres fitted for unnecessarily long periods. Vehicles with summer tyres handle better when the roads are free of snow and ice.

If you have a flat tyre, please refer to the notes on the spare wheel
⇒ page 255, New tyres and wheels.



WARNING

The maximum speed for the winter tyres must not be exceeded. Otherwise, this could lead to tyre damage and risk of accident.



For the sake of the environment

Fit your summer tyres again as soon as possible. They are quieter, do not wear so quickly and reduce fuel consumption.

Snow chains

Snow chains are only permitted on front wheels and only for tyres 195/65R15 and 205/55R16. These tyres may only be fitted with fine-pitch link chains which do not protrude more than 15 mm ⇒ page 290.

Other tyres may use fine-pitch links which do not protrude more than 9 mm, including tension device.

Remove wheel hub covers and trim rings before fitting snow chains. For safety reasons cover caps, available in any Technical Service, must then be fitted over the wheel bolts.



WARNING

Snow chains should be correctly tightened in accordance with the manufacturer's instructions. This will prevent the chains coming into contact with the wheel housing.

**CAUTION**

Remove the snow chains to drive on roads without snow. Otherwise they will impair handling, damage the tyres and wear out very quickly.

**Note**

- In some countries, the speed limit for using snow chains is 50 km/h (30 mph). The legal requirements of the country should be followed.
- We recommend that you ask your Technical Service for information about appropriate wheel, tyre and snow chain size.



If and when

Vehicle tools, tyre repair kit and spare wheel

Vehicle Tools

The vehicle tools are located under the floor panel in the luggage compartment.

- Lift the cover of the luggage compartment, by pulling it up with a finger in the fitting.
- Take the vehicle tools out of the vehicle.

The vehicle tool kit includes:

- Jack*
- Hook for removing wheel covers* or hub caps*
- Box spanner for wheel bolts*
- Towline anchorage
- Adapter for the anti-theft wheel bolts*

Some of the items listed are only provided in certain model versions, or are optional extras.

WARNING

- The factory-supplied jack is only designed for changing wheels on this model. On no account attempt to use it for lifting heavier vehicles or other loads. Risk of injury.
- Use the jack only on a firm, level ground.

WARNING (Continued)

- Never start the engine when the vehicle is on the jack. Risk of accident.
- If work is to be carried out underneath the vehicle, this must be secured by suitable stands. Otherwise, there is a risk of injury.

Compact spare wheel* (temporary spare wheel)

The compact spare wheel (temporary spare wheel for vehicles without the anti-puncture kit) should only be used when strictly necessary.



Fig. 173 Luggage compartment. Access to the spare wheel

The temporary spare wheel is stored under the floor panel in the luggage compartment and is attached by a thumbnut.

How to use the temporary spare wheel

Should you ever have a punctured tyre, the temporary spare wheel is only intended for temporary use until you can reach a workshop. The standard-size road wheel should be replaced as soon as possible.

Please note the following restrictions when using the temporary spare wheel. This temporary spare wheel has been specially designed for your vehicle, thus, it cannot be changed with the temporary spare wheel from another vehicle.

No other type of tyre (normal summer or winter tyre) may be fitted on the compact temporary spare wheel rim.

Snow chains

For technical reasons, snow chains must **not** be used on the compact temporary spare wheel.

If you have a puncture on one of the *front wheels* when using snow chains, fit the compact temporary spare wheel in place of one of the rear wheels. You can then attach the snow chains to the wheel taken from the rear and use this wheel to replace the punctured front wheel.



WARNING

- The tyre pressures must be checked and corrected as soon as possible after fitting the temporary spare wheel. The temporary spare wheel pressure for dimensions 125/70R16 125/70R18 135/90R16 is 4.2 bar; for all other tyre dimensions please refer to the label on the fuel cap. Failure to do so could result in an accident.
- Do not drive faster than 80 km/h (50 mph). Higher speeds can cause an accident.
- Avoid heavy acceleration, hard braking and fast cornering. Risk of accident.



WARNING (Continued)

- Never use more than one temporary spare wheel at the same time, risk of accident.
- No other type of tyre (normal summer or winter tyre) may be fitted on the compact temporary spare wheel rim.

Tyre repair kit*

The tyre repair kit (for vehicles not including a temporary spare wheel) is stored under the floor panel in the luggage compartment.

Your vehicle is equipped with the Tyre Mobility System (tyre repair kit).

The tyre repair kit consists of a container with sealing product to repair the puncture and a **compressor** to generate the required tyre pressure. The kit will reliably seal punctures up to a size of about 4 mm caused by the penetration of a foreign body into the tyre.



Note

- Seek professional assistance if the repair of a tyre puncture is not possible with the sealing product.

Wheel change

Preparation work

What you must do before changing a wheel.

- If you have a flat tyre or puncture, park the vehicle as far away from the flow of traffic as possible. Choose a location that is as level as possible.
- All vehicle occupants should leave the vehicle. They should wait in a safe area (for instance behind the roadside crash barrier).
- Switch off the engine. Switch on the hazard warning lights.
- Apply the **handbrake** firmly.
- Engage the **first gear**, or put the selector lever to position **P** for those vehicles with an automatic gearbox.
- If you are towing a trailer, unhitch it from your vehicle.
- Take the **vehicle tools** and the **spare wheel** out of the luggage compartment.



WARNING

Put the hazard warning lights on and place the warning triangle in position. This is for your own safety and also warns other road users.



CAUTION

If you have to change the tyre on a gradient, block the wheel opposite the wheel being changed by placing a stone or similar object under it to prevent the vehicle from rolling away.



Note

Please observe legal requirements when doing so. ■

Changing a wheel

Change the wheel as described below

- Remove the **wheel cover**. Also refer to ⇒ Fig. 174
- Slacken the **wheel bolts**.
- **Raise** the vehicle with the jack at the corresponding area
- **Remove** the wheel and **put on** the spare one
- **Lower** the vehicle.
- Tighten the wheel bolts **firmly** with the box spanner
- Replace the **hub cap**. ■

After changing a wheel

After changing the wheel there are still tasks to complete.

- Put the tools and jack back in the luggage compartment. ►

- Place the wheel with the defective tyre in the luggage compartment and secure it.
- Check the tyre pressure of the newly fitted tyre as soon as possible.
- Have the tightening torque of the wheel bolts checked as soon as possible with a torque wrench. The prescribed torque must be 120 Nm.

**Note**

- If you notice that the wheel bolts are corroded and difficult to turn when changing a wheel, they must be replaced before having the wheel bolt tightening torque checked.
- For safety reasons, drive at moderate speeds until the wheel bolt tightening torque has been checked. ■

Wheel trims

The wheel trims must be removed to gain access to the wheel bolts.



Fig. 174 Changing a wheel: Removing a hub cap

Removing

- Insert the **extraction hook** from the tools into the designated ring, located in one of the bolt hole covers of the wheel cover ⇒ Fig. 174.
- Pull off the **hub cap**. ■

Wheel covers*

The wheel covers must be removed for access to the wheel bolts

Removing

- Remove the wheel cover using the wire hook.
- Hook this into one of the cut-outs of the wheel cover.

Fitting

- Fit the wheel cover onto the wheel rim by pressing it firmly. Put pressure initially on the point of the cut-out for the valve. Then press the wheel cover onto the steel rim so that it engages all round.

Loosening the wheel bolts

The wheel bolts must be loosened before raising the vehicle.



Fig. 175 Changing a wheel: loosen the wheel bolts

Loosening

- Fit the **box spanner** as far as it will go over the wheel bolt.
- Grasp the box spanner by the end turn it about one full turn to the **left** → Fig. 175.

Tightening

- Fit the box spanner as far as it will go over the wheel bolt.
- Grasp the box spanner close to the end and turn the bolt to the **right** until it is secured.
- An adapter is required to unscrew or tighten the anti-theft wheel bolts.

! WARNING

Loosen the wheel bolts only about one turn before raising the vehicle with the jack, loosening the wheel bolts more than one turn can result in an accident.



Note

- If the wheel bolt is very tight, you may be able to loosen it by pushing down the end of the spanner carefully with your foot. Hold on to the vehicle for support and take care not to slip.

Raising the vehicle

In order to remove the wheel, the vehicle must be raised with a jack.

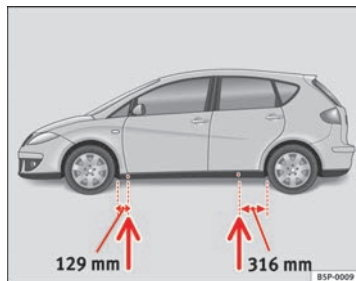

Fig. 176 Jack position points

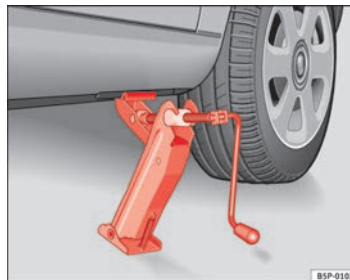

Fig. 177 Fitting the jack

- Locate the jacking point under the door sill closest to the wheel to be changed ⇒ Fig. 176.
- Place the jack under the jacking point and turn the crank until the arm of the jack is directly below the vertical rib under the door sill.
- Align the jack so that the arm of the jack fits around the rib under the door sill and the movable base plate of the jack is flat on the ground ⇒ Fig. 177.
- Raise the jack until the defective wheel is just clear of the ground.

Recesses at the front and rear of the door sills mark the jacking points ⇒ Fig. 176. There is only one jacking point for each wheel. Do not fit the jack anywhere else.

An **unstable surface** under the jack may cause the vehicle to slip off the jack. Therefore, the jack must be fitted on solid ground offering good support. Use a large and stable base, if necessary. On a hard, slippery surface (such as tiles) use a rubber mat or similar to prevent the jack from slipping. ►

! WARNING

- Take all precautions so that the base of the jack does not slip. Failure to do so could result in an accident.
- The vehicle can be damaged if the jack is not applied at the correct jacking points. There is also a risk of injury since the jack can slip off suddenly if it is not properly engaged.

Removing and fitting the wheel

For removal and fitting the wheel, the following tasks must be completed.

Change the wheel as described below after loosening the wheel bolts and raising the vehicle with the jack.

Removing a wheel

- Unscrew the wheel bolts using the box spanner and place them on a clean surface.

Fitting a wheel

- Screw on the wheel bolts in position and tighten them loosely with a box spanner.

The wheel bolts should be clean and easily screwed. Before fitting the spare wheel, inspect the wheel condition and hub mounting surfaces. These surfaces must be clean before fitting the wheel.

If tyres with a specific direction of rotation are fitted, note the direction of rotation.

Anti-theft wheel bolts*

A special adapter is required to turn the anti-theft wheel bolts.

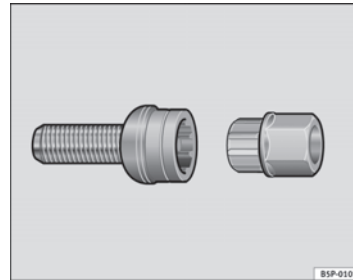

Fig. 178 Anti-theft wheel bolt

- Insert the adapter onto the wheel bolt and push it on as far as it will go → Fig. 178.
- Fit the box spanner as far as it will go over the adapter.
- Loosen or tighten the wheel bolt as appropriate.

Code

The code number of the anti-theft wheel bolt is stamped onto the front part of the adaptor.

The code number should be noted and kept in a safe place, as it is only by using the code number that a duplicate adaptor can be obtained from the SEAT Official Services.

Tyres with directional tread pattern

Tyres with directional tread pattern must be fitted so that they rotate in the correct direction.

A directional tread pattern can be identified by arrows on the sidewall that point in the direction of rotation. Always note the direction of rotation indicated when fitting the wheel. This is important so that these tyres can give maximum grip and avoid excessive noise, tread wear and aquaplaning.

If, in an emergency, you have to mount the spare wheel so it rotates in the wrong direction, you must drive extremely carefully. The tyre will not give optimum performance. This is particularly important when driving on wet roads.

To benefit from the advantages of tyres with this type of tread pattern, the defective tyre should be replaced as soon as possible so that all tyres again rotate in the correct direction. ■

Tyre repair kit (Tyre-Mobility-System)*

General information and safety notes

Your vehicle is equipped with a tyre repair kit: the **Tyre Mobility System**.

In the event of a tyre puncture, a **sealing product** and an **air compressor** are located in the luggage compartment under the floor panel.

The Tyre Mobility System will reliably seal punctures caused by the penetration of a foreign body of up to about 4 mm in diameter.

It is not necessary to remove the foreign body from the tyre.

Instructions for the sealing product are located on the sealing compound container.

Notes for the proper use of the air compressor are included in an additional instruction leaflet.



WARNING

- **Do not attempt to repair a puncture with the sealing product if the tyre has been damaged by driving the vehicle after the tyre has lost its air.**
- **Always observe warnings and follow instructions concerning compressor and sealing compound carefully.**
- **Do not drive faster than 80 km/h (50 mph), avoid heavy acceleration, hard braking and fast cornering.**
- **Tyres which have been repaired with sealing compound are only suitable for temporary use over a short period. Therefore, please drive carefully to the next available specialised workshop.**



For the sake of the environment

If you have to dispose of a sealant can, go to a specialised waste service or to a SEAT Technical Service, where the product can be recycled in an appropriate waste container.



Note

- If sealing product should leak out, leave it to dry. This way you can pull it off like a piece of foil.
- Observe the expiry date stated on the sealing compound can. Have the sealing compound exchanged by a specialised workshop.
- Seek professional assistance if the repair of a tyre puncture is not possible with the sealing product. ■

Preparation work

Certain steps must be taken before repairing a tyre.

- If you have a flat tyre or puncture, park the vehicle as far away from the flow of traffic as possible.
- Apply the **handbrake** firmly.
- Engage **first gear**, or put the selector lever to position **P**.
- All occupants should **leave** the vehicle. They should wait in a safe area (for instance behind the roadside crash barrier).
- Check whether a repair is possible using the Tyre Mobility System “General information and safety notes.”
- Unscrew inflation cap from the affected wheel.
- Take the **tyre repair kit** out of the luggage compartment.



WARNING

Put the hazard warning lights on and place the warning triangle in position. This is for your own safety and also warns other road users.



CAUTION

Take special care if you have to repair a tyre on a slope.



Note

Please observe legal requirements when doing so.

Tyre repair

The following sections describe the procedures for repairing a tyre.

Using the sealing product

- The instructions on the container give detailed information on how to use the sealing product.

Inflating the tyre.

- Remove the air compressor and hose from the container.
- Screw the retaining nut onto the valve.
- Plug the compressor cable into a 12 volt power socket.
- Turn on compressor and monitor the pressure shown on the pressure gauge.

Completing the repair

- Remove the compressor hose from the valve.
- Fit the valve cap.
- Unplug the compressor from the socket.
- Return all tools to their proper storing location.



Note

- If the vehicle is equipped with tyre pressure control, enter the new tyre pressures using the SET button on the centre console.
- The compressor should never be allowed to run for longer than 6 minutes.

Fuses

Changing a fuse

Blown fuses must be replaced

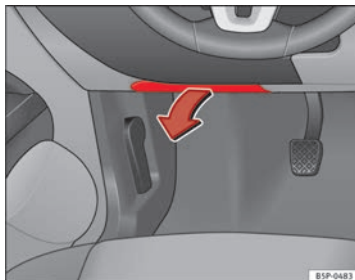

Fig. 179 Left side of dash panel: Fuse box cover

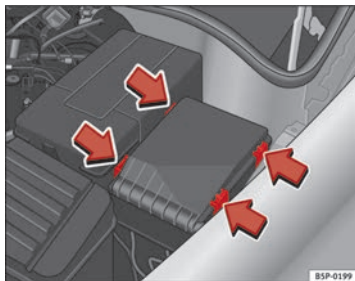

Fig. 180 Fuse box cover in engine compartment

Fuse cover underneath the steering wheel

- Switch off the ignition and the component concerned.
- Identify the fuse corresponding to the damaged electric consumer ⇒ page 270.
- Take the plastic clip from inside the fuse cover, fit it onto the blown fuse and pull the fuse out.
- Replace the blown fuse (which will have a melted metal strip) with a new fuse of the same ampere rating.

Fuse cover in engine compartment

- Switch off the ignition and its failed electrical component.
- Prise off the fuse cover in the engine compartment by pressing the tabs towards the centre of the cover ⇒ Fig. 180.
- Identify the fuse for the failed component ⇒ page 270.
- Take the plastic clip from inside the fuse cover (at left-hand end of the dash panel), fit it onto the blown fuse and pull the fuse out.
- Replace the blown fuse (which will have a melted metal strip) with a new fuse of the same ampere rating.
- Carefully fit the fuse cover back on to ensure no water can enter the fuse box.

The individual electrical circuits are protected by fuses. The fuses are located behind a cover at the left-hand end of the dash panel and on the left-hand side of the engine compartment. ▶

The electric windows are protected by **circuit breakers**. These reset automatically after a few seconds when the overload (caused for example by frozen windows) has been corrected.

Fuses colour code

Colour	Amps
Light brown	5
Red	10
Blue	15
Yellow	20
Natural (white)	25
Green	30
Orange	40
Red	50
White	80
Blue	100
Grey	150
Violet	200



WARNING

Never “repair” damaged fuses and never replace them with fuses with a higher rating. Failure to comply could result in fire. This could also cause damage to other parts of the electrical system.



Note

- If a newly replaced fuse blows again after a short time, the electrical system must be checked by a specialised workshop as soon as possible.
- If you replace a fuse with higher-rating fuse, you could cause damage to another location in the electrical system.

- Always keep some spare fuses in the vehicle. These are available from SEAT Official Services.
- In addition to the fuses listed in the following tables, there are other fuses which must be replaced by the Technical Service Workshop. ■

Fuses on left side of dash panel

Fuses

Number	Consumer	Amps
1	Vacant	
2	Vacant	
3	Vacant	
4	Vacant	
5	Vacant	
6	Vacant	
7	Vacant	
8	Vacant	
9	Airbag	5
10	RSE input (roof screen)	10
11	Vacant	
12	Left xenon headlight	10
13	Instrument panel (oil level)/Switchboard wiring (BCM)/Heater / ABS, ESC / Park Pilot/ Gateway/ Flow meter	5
14	Gearbox/ Power steering/ Brake light sensor/ Trailer/ ABS, ESC/ Haldex/ Light switch	10
15	Heated windscreen / Instrument lighting / Diagnosis switchboard/Engine management/Additional heating/AFS headlights/Park Pilot	10
16	Right xenon headlight	10
17	Engine management/RSE system with START-STOP	10
18	Kombi/levers with START-STOP	5
19	Navigation/Radio with START-STOP	15
20	Park Pilot (parking aid) / Gear lever/ ESC switchboard	10

Number	Consumer	Amps
21	Vacant	
22	Volumetric alarm sensor/ Alarm horn	5
23	Diagnosis / Rain sensor / Light switch	10
24	Trailer hook pre-installation assistant	15
25	Vacant	
26	Vacuum pump	20
27	RSE supply (Ceiling display) without START-STOP	10
28	Rear window wiper motor	20
29	Vacant	
30	Cigarette lighter/power socket	20
31	Vacant	
32	Vacant	
33	Heater	40
34	Vacant	
35	Vacant	
36	Vacant	
37	Vacant	
38	Vacant	
39	Trailer control unit (coupling)	15
40	Trailer control unit (turn signals, brakes and left side)	20
41	Trailer control unit (fog light, reverse light and right side)	20
42	BCM wiring switchboard	20
43	Trailer pre-installation	40
44	Heated rear window	25
45	Electric windows (front)	30
46	Rear electric windows	30
47	Engine (Fuel control unit, petrol relay)	15

Number	Consumer	Amps
48	Convenience controls	20
49	Heating controls	40
50	Heated seats	30
51	Sunroof	20
52	Headlight washer system	20
53	Trailer hook pre-installation assistant	20
54	Taxi (taximeter power supply)	5
55	Trailer hook pre-installation assistant	20
56	Taxi (transmitter power supply)	15
57	Telephone power supply with START-STOP	10
58	Central locking control unit	30

Some of the electrical items listed in the table are only fitted on certain models or are optional extras.

Please note that the above list, while correct at the time of printing, is subject to alterations. If discrepancies should occur, please refer to the sticker on the inside of the fuse cover for the correct information for your model. ■

Fuses layout, engine compartment, left part

Fuses

Number	Consumer	Amps
1	Windscreen wipers	20
2	DQ200 gearbox	30
3	Cable control unit	5
4	ABS	20
5	AQ gearbox	15
6	Instrument panel/Steering column	5

Number	Consumer	Amps
7	Ignition key	40
8	Radio	15
9	Telephone/TomTom Navigator	5
10	Engine management	5
	Engine management	10
11	Vacant	
12	Electronic control unit	5
13	Petrol injection module supply	15
	Diesel injection module supply	30
14	Coil	20
15	Engine management	5
	Pump relay	10
16	Right lighting	30
17	Horn	15
18	Vacant	
19	Clean	30
	Water pump	10
20	Pressure sensor pump for 1.8 engine	20
21 ^{a)}	Lambda probe	15
22	Brake pedal, speed sensor	5
	Engine management	5
23 ^{a)}	Engine management	10
	Engine management	15
24	AKF, gearbox valve	10
25 ^{a)}	ABS pump	40
26	Left lighting	30
27 ^{a)}	Engine management	40
	Engine management	50
28	Vacant	

Number	Consumer	Amps
29 ^{a)}	Electric windows (front and back)	50
	Electric windows (front)	30
30	Ignition key	50

^{a)} Ampere rating according to motorisation

Bulb change

General notes

Before changing any bulb, first turn off the failed component.

Do not touch the glass part of the bulb with your bare hands. The fingerprints left on the glass will vaporise as a result of the heat generated by the bulb, causing a reduction in bulb life and condensation on the mirror surface, thus reducing effectiveness.

A bulb must only be replaced by one of the same type. The type is indicated on the bulb, either on the glass part or on the base.

It is highly recommended to keep a box of spare bulbs in the vehicle. At the very least, the following spare bulbs, which are essential for road safety, should be kept in the vehicle.

Main headlights

Dipped beam - H7

Main beam - H1

Side - W5W

Turn signal - PY21W

Xenon headlights¹⁾ /adaptive*

Dipped and full beam - D1S²⁾

Daylight - P21W SLL

Side - W5W

Turn signals - PY21W

Fog light

Fog light - H3

Upper tail light

Stop/Position - P21W³⁾

Turn signal - R10W

Lower tail light

Fog light - P21W

Reverse light - P21W

Side turn signal

Side turn signal - W5W

¹⁾ On this type of headlight, the bulb changes must be made by the Technical Service, given that complex elements must be removed from the vehicle and a reset must be made on the automatic control system incorporated.

²⁾ The Xenon bulbs discharge 2.5 times the light flux and have an average lifespan of 5 times more than that of halogen bulbs, this means that, except due to unusual circumstances, there is no need to change the bulbs for the whole life of the vehicle.

³⁾ Electronically controlled single filament bulb for Stop/side bulbs. If the bulb blows it will not work in either position or Stop.

Number plate light

Number plate light - C5W



Note

- Depending on weather conditions (cold or wet), the headlights, the fog lights, the tail lights and the turn signals may be temporarily misted. This has no influence on the useful life of the lighting system. By switching on the lights, the area through which the beam of light is projected will quickly be demisted. However, the edges may continue to be misted.
- Please check at regular intervals that all lighting (especially the exterior lighting) on your vehicle is functioning properly. This is not only in the interest of your own safety, but also that of all other road users.
- Due to the difficulty in accessing some of the bulbs, any replacement work should be done by a Technical Service. However, the following is a description of how to change the lamps except for the fog lights* and interior lamps.

Main headlight bulbs

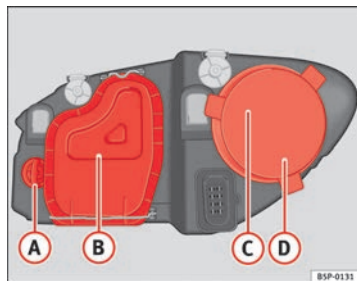

Fig. 181 Main headlight bulbs

- (A) Turn signal
- (B) Dipped beam headlights
- (C) Main beam headlights
- (D) Side light

Turn signal bulbs

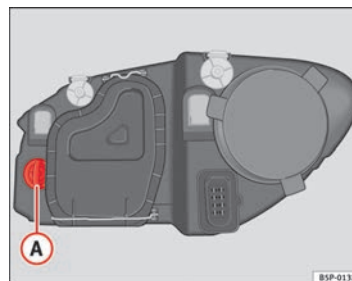

Fig. 182 Turn signal bulb

- Raise the bonnet.
- Turn bulb holder ⇒ Fig. 182 (A) to the left and pull.
- Remove the bulb by pressing on the bulb holder and rotating at the same time to the left.
- Installation involves the above steps in reverse sequence.

Dipped lights

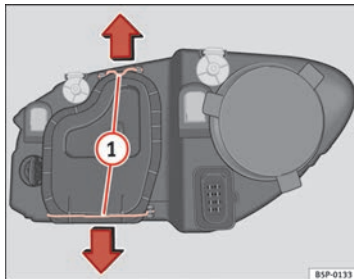

Fig. 183 Dipped beam headlights

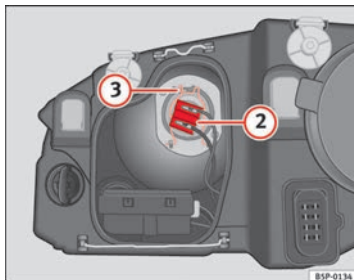
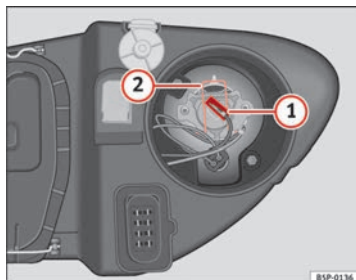
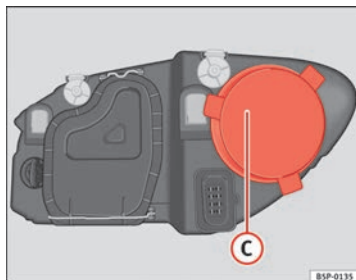

Fig. 184 Dipped beam headlights

- Remove connector ⇒ Fig. 184 ② from the bulb.
 - Unclip the retainer spring ⇒ Fig. 184 ③ pressing inwards to the right.
 - Extract the bulb and fit the replacement so that the rim of the attachment plate is on the reflector cut-out. ■
- Raise the bonnet.
 - Move the loops ⇒ Fig. 183 ① in the direction of the arrow and remove the cover.

Main beam lights



- Press the spring ⇒ Fig. 186 ② inwards and to the right.
- Extract the bulb and fit the replacement so that it sits correctly into the cut-out on the reflector.
- Installation involves the above steps in reverse sequence. ■

- Raise the bonnet.
- Remove the cover ⇒ Fig. 185 ③ by pulling on this.
- Remove connector ⇒ Fig. 186 ① from the bulb.

Side lights

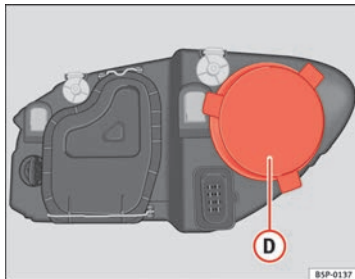

Fig. 187 Side light

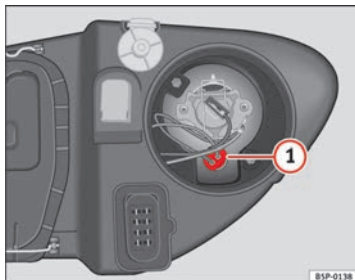

Fig. 188 Side light

- Raise the bonnet.
- Remove the cover ⇒ Fig. 187 **D** by pulling on this.
- Extract the bulb holder ⇒ Fig. 188 **1** outwards.

- Replace the bulb by pulling it out and inserting the replacement.
- Installation is done in the reverse order. ■

Tail lights

- Side light
- Brake lights
- Turn signals
- Reverse lights
- Rear fog light

Side lights/ brake lights

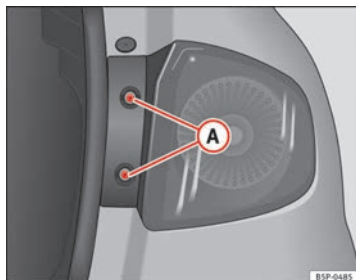

Fig. 189 Side lights and brake lights

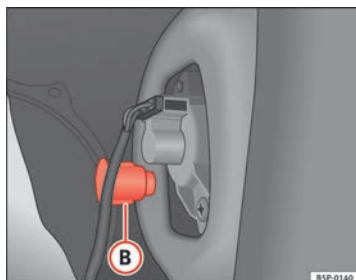

Fig. 190 Side lights and brake lights

- Open the rear lid.
- Remove the bolts ⇒ Fig. 189 **A**.
- Remove the cover of the luggage compartment lateral panel.

- Unscrew the plastic fitting ⇒ Fig. 190 **B** securing the tail light. Inserting a screwdriver under the plastic fitting may help to loosen it.
- Partially remove the tail light from its casing taking care not to pull on the cable.
- Remove the bulb holder connector.
- Unscrew the bolts ⇒ Fig. 191 **C** from the bulb holder and pull on this.
- Press on the bulb and rotate to the left then fit the replacement.
- To refit follow the steps in reverse order, taking special care when fitting the bulb holder. The metal contacts of the bulb holder ends should be correctly fitted with respect to the tail light contacts. ■

Turn signal light

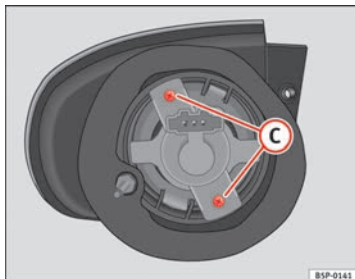

Fig. 191 Turn signal

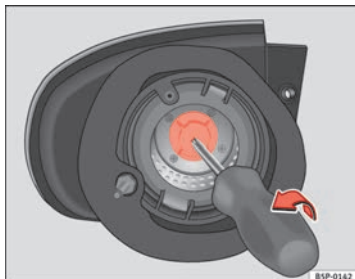

Fig. 192 Turn signal light.

- Remove the diode from its housing ⇒ page 277.
- Unscrew the bolts ⇒ Fig. 191 C from the bulb holder and pull on this.

- Pull out the turn signal bulb holder using a screw driver in the direction of the arrow ⇒ Fig. 192.
- Fit the replacement bulb by pressing it down and rotating to the left.
- Installation involves the above steps in reverse sequence. ■

Reverse light/rear fog light

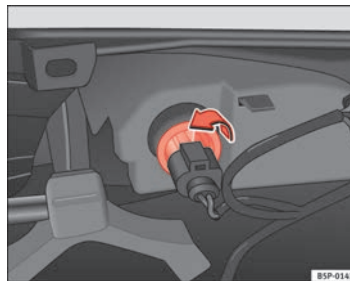

Fig. 193 Lamp on interior side of bumper

- Rotate the bulb holder to the left, and remove it in the direction of the arrow ⇒ Fig. 193.
- Replace the bulb by pressing on it and rotating at the same time to the left ■

Side turn signals

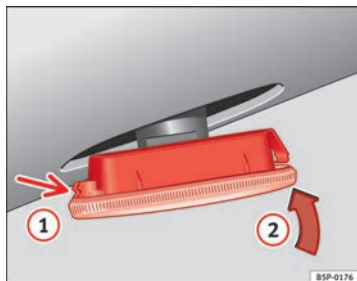

Fig. 194 Side turn signal

- Press the turn signal to the left or to the right to remove the bulb.
- Remove the bulb holder from the turn signal.
- Remove the failed glass bulb and replace with a new bulb.
- Insert the bulb holder in the turn signal guide until it clicks into place.
- First place the turn signal in the opening in the bodywork, fixing the tabs ⇒ Fig. 194, arrow ①.
- Insert the bulb as shown by the arrow ② ⇒ Fig. 194.

Luggage compartment lights

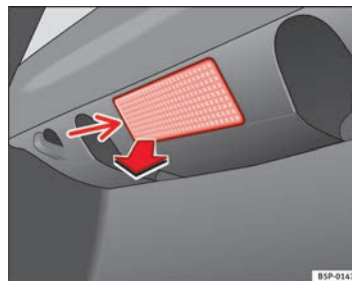

Fig. 195 Luggage compartment light

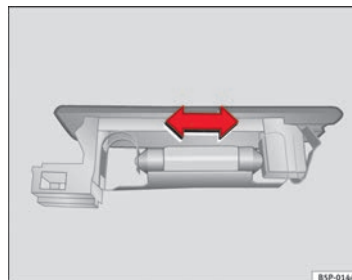

Fig. 196 Luggage compartment light

- Extract the bulb by pressing on its inside edge -arrow- using the flat side of a screwdriver ⇒ Fig. 195.

- Press the bulb sideways and remove it from its housing
⇒ Fig. 196.

Registration light

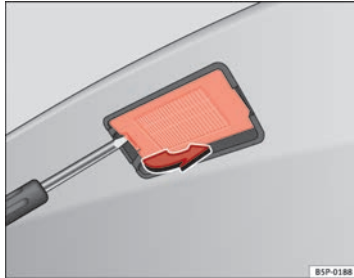

Fig. 197 Number plate light



Fig. 198 Number plate light

- Remove the bulb, carefully using the flat side of a screwdriver as a lever inserted in the crack as shown by the arrow ⇒ Fig. 197.
- Remove the bulb, moving it in the direction of the arrow and outwards ⇒ Fig. 198.

Sun visor light

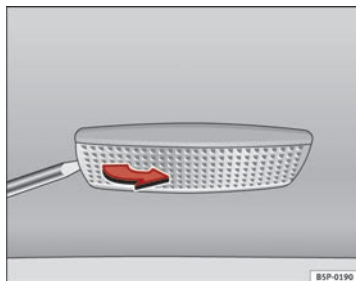

Fig. 199 Removing sun visor light

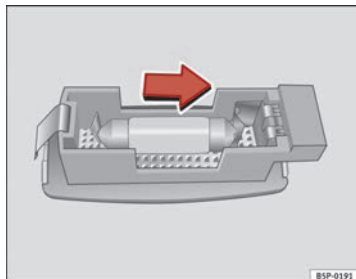

Fig. 200 Removing sun visor light

- Carefully remove the lamp, using the flat side of a screwdriver, as shown in the figure ⇒ Fig. 200.

- Remove the bulb, moving it in the direction of the arrow and outwards ⇒ Fig. 200.

Jump-starting

Jump leads

The jump lead must have a sufficient wire cross section.

If the engine fails to start because of a discharged battery, the battery can be connected to the battery of another vehicle to start the engine.

Jump leads

Jump leads must comply with standard **DIN 72553** (see cable manufacturer's instructions). The wire cross section must be at least 25 mm² for petrol engines and at least 35 mm² for diesel engines.



Note

- The vehicles must not touch each other, otherwise electricity could flow as soon as the positive terminals are connected.
- The discharged battery must be properly connected to the on-board network.

How to jump start: description

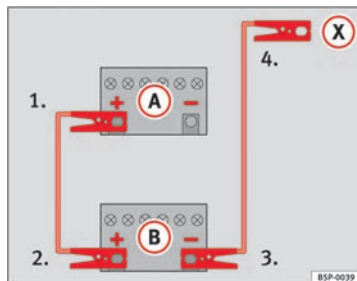

Fig. 201 Diagram of connections for vehicles without Start-Stop system

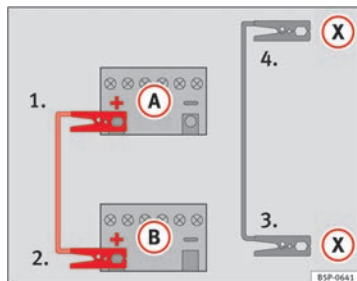

Fig. 202 Diagram of connections for vehicles with Start-Stop system

Jump lead terminal connections

1. Switch off the ignition of both vehicles ⇒ Δ .
2. For vehicles without Start-Stop system:

- Connect one end of the *red* jump lead to the positive \oplus terminal of the vehicle with the flat battery \textcircled{A} ⇒ Fig. 201.
- Connect the other end of the *red* jump lead to the positive terminal \oplus in the vehicle providing assistance \textcircled{B} .
- Connect one end of the *black* jump lead to the negative terminal \ominus of the vehicle providing assistance \textcircled{B} ⇒ Fig. 201.
- Connect the other end of the *black* jump lead \textcircled{X} to a solid metal component bolted to the engine block or to the engine block itself of the vehicle with the flat battery. However, connect it to a point as far as possible from the battery \textcircled{A} .

3. For vehicles with Start-Stop system:

- Connect one end of the *red* jump lead to the positive \oplus terminal of the vehicle with the flat battery \textcircled{A} ⇒ Fig. 202.
 - Connect the other end of the *red* jump lead to the positive terminal \oplus in the vehicle providing assistance \textcircled{B} .
 - Connect one end of the *black* jump lead \textcircled{X} to a suitable ground terminal, a solid piece of metal in the engine block, or to the engine block ⇒ Fig. 202.
 - Connect the other end of the *black* jump lead \textcircled{X} to a solid metal component bolted to the engine block or to the engine block itself of the vehicle with the flat battery. However, connect it to a point as far as possible from the battery \textcircled{A} .
4. Position the leads in such a way that they cannot come into contact with any moving parts in the engine compartment. ▶

Starting

5. Start the engine of the vehicle with the boosting battery and let it run at idling speed.
6. Start the engine of the vehicle with the flat battery and wait two or three minutes until the engine is “running”.

Removing the jump leads

7. Before you remove the jump leads, switch off the dipped beam headlights (if they are switched on).
8. Turn on the heater blower and heated rear window in the vehicle with the flat battery. This helps minimise voltage peaks which are generated when the leads are disconnected.
9. When the engine is running, disconnect the leads in reverse order to the details given above.

Connect the battery clamps so they have good metal-to-metal contact with the battery terminals.

If the engine fails to start, switch off the starter after about 10 seconds and try again after about half a minute.

WARNING

- Please note the safety warnings referring to working in the engine compartment ⇒ page 233, Working in the engine compartment.
- The battery providing assistance must have the same voltage as the flat battery (12V) and approximately the same capacity (see imprint on battery). Failure to comply could result in an explosion.

WARNING (Continued)

- Never use jump leads when one of the batteries is frozen. Danger of explosion! Even after the battery has thawed, battery acid could leak and cause chemical burns. If a battery freezes, it should be replaced.
- Keep sparks, flames and lighted cigarettes away from batteries, danger of explosion. Failure to comply could result in an explosion.
- Observe the instructions provided by the manufacturer of the jump leads.
- Do not connect the negative cable from the other vehicle directly to the negative terminal of the flat battery. The gas emitted from the battery could be ignited by sparks. Danger of explosion.
- Do not attach the negative cable from the other vehicle to parts of the fuel system or to the brake line.
- The non-insulated parts of the battery clamps must not be allowed to touch. The jump lead attached to the positive battery terminal must not touch metal parts of the vehicle, this can cause a short circuit.
- Position the leads in such a way that they cannot come into contact with any moving parts in the engine compartment.
- Do not lean on the batteries. This could result in chemical burns.

Note

The vehicles must not touch each other, otherwise electricity could flow as soon as the positive terminals are connected. ■

Towing and tow-starting

Tow-starting

The use of jump leads is preferable to tow-starting.

We recommend that you do **not** tow-start your vehicle. Jump-starting is preferable ⇒ page 281.

However, if your vehicle has to be tow-started:

- Engage the 2nd or the 3rd gear.
- Keep the clutch pressed down.
- Switch the ignition on.
- Once both vehicles are moving, release the clutch.
- As soon as the engine starts, press the clutch and move the gear lever into neutral. This helps to prevent driving into the towing vehicle.



WARNING

The risk of accidents is high when tow-starting. The vehicle being towed can easily collide with the towing vehicle.



CAUTION

When tow-starting, fuel could enter the catalytic converter and damage it. ■

General notes

Please observe the following points if you use a tow rope:

Notes for the driver of the towing vehicle

- Drive slowly at first until the tow rope is taut. Then accelerate gradually.
- Begin and change gears cautiously. If you are driving an automatic vehicle, accelerate gently.
- Remember that the brake servo and power steering are not working in the vehicle you are towing. Brake sooner than normal and pressing the pedal gently.

Notes for the driver of the towed vehicle

- Ensure that the tow rope remains taut at all times when towing.

Tow rope or tow bar

It is easier and safer to tow a vehicle with a tow bar. You should only use a tow rope if you do not have a tow bar.

A tow rope should be slightly elastic to reduce the loading on both vehicles. It is advisable to use a tow rope made of synthetic fibre or similarly elastic material.

Attach the tow rope or the tow bar only to the towline anchorages provided or a towing bracket.

Driving style

Towing requires some experience, especially when using a tow rope. Both drivers should be familiar with the technique required for towing. Inexperienced drivers should not attempt to tow. ►

Do not pull too hard with the towing vehicle and take care to avoid jerking the tow rope. When towing on an unpaved road, there is always a risk of overloading and damaging the anchorage points.

The ignition of the vehicle being towed must be switched on to prevent the steering wheel from locking and also to allow the use of the turn signals, horn, windscreen wipers and washers.

As the brake servo does not work if the engine is not running, you must apply considerably more pressure to the brake pedal than you normally would.

As the power assisted steering does not work if the engine is not running, you will need more strength to steer than you normally would.

Towing vehicles with an automatic gearbox

- Put the selector lever into position "N".
- Do not drive faster than 50 km/h (30 mph).
- Do not tow further than 50 km.
- If a breakdown vehicle is used, the vehicle must be towed with the front wheels raised.



Note

- Observe legal requirements when towing or tow-starting.
- Switch on the hazard warning lights of both vehicles. However, observe any regulations to the contrary.
- For technical reasons, vehicles with an automatic gearbox must not be tow-started.
- If damage to your vehicle means that there is no lubricant in the gearbox, you must raise the driven wheels while the vehicle is being towed.
- If the vehicle has to be towed more than 50 km (30 miles), the front wheels should be raised during towing, and towing should be carried out by a qualified person.

- The steering wheel is locked when the vehicle has no electrical power. The vehicle must then be towed with the front wheels raised. Towing should be carried out by a qualified person.
- The towline anchorage should always be kept in the vehicle. Please refer to the notes on ⇒ page 284, Tow-starting. ■

Towline anchorages



Fig. 203 The front right section of the vehicle: Fitting the front towline anchorage

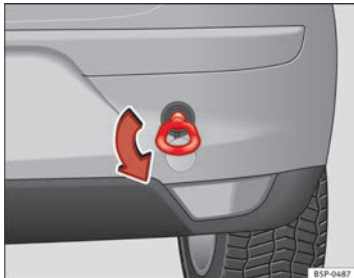

Fig. 204 Fitting the towline anchorage to the rear of the vehicle

- Remove the cover of the screw hole, insert a screwdriver into the lower slot and lever gently.
- Screw the towline anchorage as shown by the arrow *anticlockwise* to the limit position in the front → Fig. 203 or rear → Fig. 204 threaded hole.

Fitting the towline anchorage

- Take the towline anchorage from the on-board tool set.
- Remove the front cover by pressing down on its left-hand side.

Technical Specifications

Description of specifications

Important information

Important

The information in your vehicle's official documents always take precedence over the information in the current instruction manual.

All technical specifications provided in this documentation are valid for the standard model in Spain. The vehicle data card included in the Maintenance Programme or the vehicle registration documents shows which engine is installed in the vehicle.

The figures may be different depending whether additional equipment is fitted, for different models, for special vehicles and for other countries.

Abbreviations used in the Technical Specifications section

Abbreviation	Meaning
kW	Kilowatt, engine power measurement.
PS	Pferdestärke (horsepower), formerly used to denote engine power.
rpm	Revolutions per minute - engine speed.
Nm	Newton metres, unit of engine torque.
l/100 km	Fuel consumption in litres per 100 km.
g/km	Carbon dioxide emissions in grams per km travelled.
CO ₂	Carbon dioxide

Abbreviation	Meaning
CN	Cetane number, indication of the diesel combustion power.
RON	Research octane number, indication of the knock resistance of petrol.

Vehicle identification data

The most important information is given on the identification plate and the vehicle data sticker.

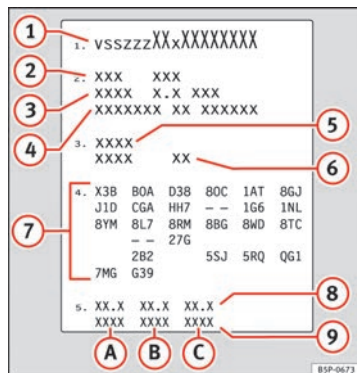

Fig. 205 Vehicle data sticker (luggage compartment)

Vehicles for certain export countries do not have an identification plate.

Identification plate

The identification plate is located on the left rib inside the engine compartment.

Vehicle identification number

The vehicle identification number (chassis number) can be read from outside the vehicle through a viewer in the windscreen. This is located on the left-hand side of the vehicle in the lower area of the windscreen. It is also located on the right hand side of the engine compartment.

Vehicle data

The data sticker is placed on the inside of the spare wheel well, in the luggage compartment and on the rear cover of the Maintenance Programme.

The following information is provided on the vehicle data sticker: ⇒ Fig. 205

- ① Production control number
- ② Vehicle identification number (chassis number)
- ③ Model code number
- ④ Model designation/engine power output
- ⑤ Engine and gearbox code letters
- ⑥ Paintwork number/interior trim code
- ⑦ Optional equipment codes
- ⑧ Consumption values
- ⑨ CO₂ emissions values

At the end of the data sticker, in points ⑧ and ⑨, you can see the consumption and emission information.

Information on consumption and emissions

- Ⓐ Urban consumption (l/100 km)
Urban CO₂ emissions (g/km)
- Ⓑ Extra-urban consumption (l/100 km)
Extra-urban CO₂ emissions (g/km)
- Ⓒ Combined consumption (l/100 km)
Combined CO₂ emissions (g/km)

Information on fuel consumption

Fuel consumption

The consumption and emission details shown on the vehicle data sticker differ from one vehicle to another.

The vehicle fuel consumption and CO₂ emissions can be consulted on the vehicle data sticker in the spare wheel well, inside the luggage compartment and on the rear cover of the Maintenance Programme.

The fuel consumption and CO₂ emission values refer to the weight category assigned to your vehicle according to the engine and gearbox combination, as well as the specific equipment fitted, and is only used to compare between the different models.

The fuel consumption and CO₂ emissions do not depend only on the performance of the vehicle, they can also differ from the established values depending on other factors such as driving style, road conditions, traffic conditions, environmental conditions, load and number of passengers.

Calculation of fuel consumption

The consumption values have been calculated based on measurements performed or supervised by certified CE laboratories according to the latest version of directives 715/2007/EC and 80/1268/CEE (for more information consult the European Union Publications Office at EUR-Lex: © European Union, <http://eur-lex.europa.eu/en/index.htm>) and are valid for the kerb weight indicated for the vehicle.



Note

In practice, and considering all the factors mentioned here, consumption values can differ from those calculated in the current European regulations. ■

Weights

Kerb weight refers to the basic model with a fuel tank filled to 90% capacity and without optional extras. The figure quoted includes 75 kg to allow for the weight of the driver.

For special versions and optional equipment fittings or for the addition of accessories, the weight of the vehicle will increase ⇒ ⚠.



WARNING

- **Please note that the centre of gravity may shift when transporting heavy objects; this may affect vehicle handling and lead to an accident. Always adjust your speed and driving style to suit road conditions and requirements.**
- **Never exceed the gross axle weight rating or the gross vehicle weight rating. If the allowed axle load or the allowed total weight is exceeded, the driving characteristics of the vehicle may change, leading to accidents, injuries and damage to the vehicle.**

Towing a trailer

Trailer weights

Trailer weight

The trailer weights and drawbar loads approved are selected in intensive trials according to precisely defined criteria. The approved trailer weights are valid for vehicles in the *EU* for maximum speeds of 80 km/h (50 mph) (in certain circumstances up to 100 km/h (60 mph)). The figures may be different in other countries. All data in the official vehicle documentation takes precedence over these data at all times ⇒ ⚠. ▶

Drawbar loads

The *maximum* permitted drawbar load on the ball joint of the towing bracket must not exceed **75 kg**.

In the interest of road safety, we recommend that you always tow approaching the maximum drawbar load. The response of the trailer on the road will be poor if the drawbar load is too small.

If the maximum permissible drawbar load cannot be met (e.g. with small, empty and light-weight single axle trailers or tandem axle trailers with a wheelbase of less than 1 metre), a minimum of 4% of the actual trailer weight is legally required for the drawbar load.

 **WARNING**

- For safety reasons, do not exceed the 80 km/h (50 mph) limit. This is also valid in countries where higher speeds are permitted.
- Never exceed the maximum trailer weights or the drawbar load. If the permissible axle load or the permissible total weight is exceeded, the driving characteristics of the vehicle may change, leading to accidents, injuries and damage to the vehicle.

Wheels

Tyre pressure, snow chains, wheel bolts

Tyre pressures

The sticker with the tyre pressure values can be found on the inside of the fuel tank flap. The tyre pressure values given there are for *cold* tyres. Do not reduce the slightly raised pressures of warm tyres ⇒ .

Snow chains

Snow chains may be fitted only to the *front wheels*.

Consult the section “wheels” of this manual.

Wheel bolts

After the wheels have been changed, the **tightening torque** of the wheel bolts should be checked as soon as possible with a torque wrench ⇒ . The tightening torque for steel and alloy wheels is **120 Nm**.

 **WARNING**

- Check the tyre pressure at least once per month. Checking the tyre pressure is very important. If the tyre pressure is too high or too low, there is an increased danger of accidents, particularly at high speeds.
- If the tightening torque of the wheel bolts is too low, they could loosen while the vehicle is in motion. Risk of accident! If the tightening torque is too high, the wheel bolts and threads can be damaged.

**Note**

We recommend that you ask your Technical Service for information about appropriate wheel, tyre and snow chain size.

Technical specifications

Checking fluid levels

From time to time, the levels of the different fluids in the vehicle must be checked. Never fill with incorrect fluids, otherwise serious damage to the engine may be caused.

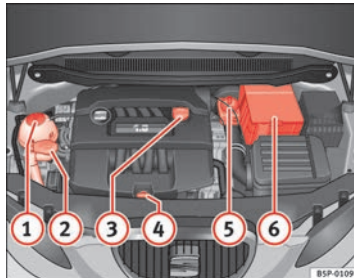

Fig. 206 Diagram for the location of the various elements

- ① Coolant expansion tank
- ② Windscreen washer reservoir
- ③ Engine oil filler cap
- ④ Engine oil dipstick
- ⑤ Brake fluid reservoir
- ⑥ Vehicle battery (underneath the cover)

The checking and refilling of service fluids are carried out on the components mentioned above. These operations are described in the ⇒ page 233.

Overview

You will find further explanations, instructions and restrictions on the technical specifications as of ⇒ page 287. ■

Petrol engine 1.4 63 kW (85 PS)

Engine specifications

Power output in kW (PS)	rpm	63 (85)/ 5000
Maximum torque	in Nm at rpm	132/ 3800
No. of cylinders/capacity	in cm ³	4/ 1390
Fuel		Super 95 RON ^{a)} /Normal 91 RON ^{b)}

a) Research Octane Number = Anti-detonation rating of the petrol.

b) Slight power loss.

Performance

Maximum speed	in km/h (mph)	169
Acceleration from 0-80 km/h (0-50 mph)	in sec.	9,8
Acceleration from 0-100 km/h (0-60 mph)	in sec.	15

Weights

Gross vehicle weight	in kg	1855
Weight in running order (with driver)	in kg	1335
Gross front axle weight	in kg	940
Gross rear axle weight	in kg	984
Permitted roof load	in kg	75

Trailer weight

Trailer without brakes	in kg	660
Trailer with brakes, gradients up to 8%	in kg	1200
Trailer with brakes, gradients up to 12%	in kg	800

Petrol engine 1.6 75 kW (102 PS)

Engine specifications

		Running on LPG	Running on petrol or E-85 ^{a)}
Power output in kW (PS)	rpm	72 (98)/ 5600	75 (102)/ 5600
Maximum torque	in Nm at rpm	144/ 3800	148/ 3800
No. of cylinders/capacity	in cm ³	4/ 1595	4/ 1595
Fuel		LPG	Super 95 RON ^{b)} /Normal 91 RON ^{c)} /E-85

a) Ethanol at 85%.

b) Research Octane Number = Anti-detonation rating of the petrol.

c) Slight power loss.

Performance

		Running on LPG	Running on petrol	Running on petrol or E-85
Maximum speed	in km/h (mph)	178	181	181
Acceleration from 0-80 km/h (0-50 mph)	in sec.	9,2	8,6	8,6
Acceleration from 0-100 km/h (0-60 mph)	in sec.	13,8	12,8	12,8

Weights

		Running on LPG	Running on petrol or E-85
Gross vehicle weight	in kg	1951	1920
Weight in running order (with driver)	in kg	1456	1395
Gross front axle weight	in kg	965	967
Gross rear axle weight	in kg	1000	980
Permitted roof load	in kg	75	75

Trailer weight

		Running on LPG	Running on petrol or E-85
Trailer without brakes	in kg	720	690
Trailer with brakes, gradients up to 8%	in kg	1500	1500
Trailer with brakes, gradients up to 12%	in kg	1200	1200

Petrol engine 1.2 77 kW (105 PS)

Engine specifications

Power output in kW (PS)	rpm	77 (105)/5000
Maximum torque	in Nm at rpm	175/1550-4100
No. of cylinders/capacity	in cm ³	4/ 1197
Fuel		Super 95 RON ^{a)} /Normal 91 RON ^{b)}

a) Research Octane Number = Anti-detonation rating of the petrol.

b) With a slight power loss

Performance

		without Start-Stop	with Start-Stop
Maximum speed	in km/h (mph)	184	184
Acceleration from 0-80 km/h (0-50 mph)	in sec.	7,3	7,3
Acceleration from 0-100 km/h (0-60 mph)	in sec.	11,3	11,3

Weights

		without Start-Stop	with Start-Stop
Gross vehicle weight	in kg	1875	1880
Weight in running order (with driver)	in kg	1355	1360
Gross front axle weight	in kg	970	970
Gross rear axle weight	in kg	980	980
Permitted roof load	in kg	75	75

Trailer weight

		without Start-Stop	with Start-Stop
Trailer without brakes	in kg	670	680
Trailer with brakes, gradients up to 8%	in kg	1500	1500
Trailer with brakes, gradients up to 12%	in kg	1200	1200

Petrol engine 1.4 92 kW (125 PS)**Engine specifications**

Power output in kW (PS)	rpm	92 (125)/ 5000
Maximum torque	in Nm at rpm	200/ 1500-4000
No. of cylinders/capacity	in cm ³	4/ 1390
Fuel		Super 95 RON ^{a)} /Normal 91 RON ^{b)}

a) Research Octane Number = Anti-detonation rating of the petrol.

b) With a slight power loss

Performance

Maximum speed	in km/h (mph)	194
Acceleration from 0-80 km/h (0-50 mph)	in sec.	6,9
Acceleration from 0-100 km/h (0-60 mph)	in sec.	10,3

Weights

Gross vehicle weight	in kg	1959
Weight in running order (with driver)	in kg	1439
Gross front axle weight	in kg	1008
Gross rear axle weight	in kg	987
Permitted roof load	in kg	75

Trailer weight

Trailer without brakes	in kg	710
Trailer with brakes, gradients up to 8%	in kg	1500
Trailer with brakes, gradients up to 12%	in kg	1300

Petrol engine 1.8 118 kW (160 PS)**Engine specifications**

Power output in kW (PS)	rpm	118 (160)4500-6200
Maximum torque	in Nm at rpm	250/1500-4500
No. of cylinders/capacity	in cm ³	4/1798
Fuel		Super 95 RON ^{a)} /Normal 91 RON ^{b)}

a) Research Octane Number = Anti-detonation rating of the petrol.

b) Slight power loss.

Performance

		Manual	Automatic
Maximum speed	in km/h (mph)	210	210
Acceleration from 0-80 km/h (0-50 mph)	in sec.	5,9	5,8
Acceleration from 0-100 km/h (0-60 mph)	in sec.	8,4	8,4

Weights

		Manual	Automatic
Gross vehicle weight	in kg	1995	2015
Weight in running order (with driver)	in kg	1475	1495
Gross front axle weight	in kg	1062	1062
Gross rear axle weight	in kg	994	994
Permitted roof load	in kg	75	75

Trailer weight

		Manual	Automatic
Trailer without brakes	in kg	730	740
Trailer with brakes, gradients up to 8%	in kg	1500	1500
Trailer with brakes, gradients up to 12%	in kg	1400	1400

Diesel engine 1.6 TDI CR 66 kW (90 PS) with/without DPF

Engine specifications

Power output in kW (PS)	rpm	66 (90) / 4200
Maximum torque	in Nm at rpm	230 / 1500-2500
No. of cylinders/capacity	in cm ³	4 / 1598
Fuel		Min, diesel acc. to DIN EN 590 51 CN ^{a)}

^{a)} Cetane Number (cetane index) = Measure of the combustion power of the diesel

Performance

Maximum speed	in km/h (mph)	172
Acceleration from 0-80 km/h (0-50 mph)	in sec.	9,1
Acceleration from 0-100 km/h (0-60 mph)	in sec.	13,8

Weights

Gross vehicle weight	in kg	1975
Weight in running order (with driver)	in kg	1455
Gross front axle weight	in kg	1045
Gross rear axle weight	in kg	960
Permitted roof load	in kg	75

Trailer weight

Trailer without brakes	in kg	720
Trailer with brakes, gradients up to 8%	in kg	1500
Trailer with brakes, gradients up to 12%	in kg	1400

Diesel engine 1.6 TDI CR 77 kW (105 PS) with/without DPF**Engine specifications**

Power output in kW (PS)	rpm	77 (105)/ 4400
Maximum torque	in Nm at rpm	250/1500-2500
No. of cylinders/capacity	in cm ³	4/1598
Fuel		Min, diesel acc. to DIN EN 590 51 CN ^{a)}

^{a)} Cetane Number (cetane index) = Measure of the diesel combustion power.

Performance

		Manual	Automatic
Maximum speed	in km/h (mph)	183	183
Acceleration from 0-80 km/h (0-50 mph)	in sec.	8	8
Acceleration from 0-100 km/h (0-60 mph)	in sec.	12,2	12,4

Weights

		Manual	Automatic
Gross vehicle weight	in kg	1975	1995
Weight in running order (with driver)	in kg	1455	1475
Gross front axle weight	in kg	1045	1065
Gross rear axle weight	in kg	960	960
Permitted roof load	in kg	75	75

Trailer weight

		Manual	Automatic
Trailer without brakes	in kg	720	730
Trailer with brakes, gradients up to 8%	in kg	1500	1500
Trailer with brakes, gradients up to 12%	in kg	1400	1400

Diesel engine 1.6 TDI CR 77 kW (105 PS) DPF Start-Stop**Engine specifications**

Power output in kW (PS)	rpm	77 (105)/ 4400
Maximum torque	in Nm at rpm	250/1500-2500
No. of cylinders/capacity	in cm ³	4/1598
Fuel		Min, diesel acc. to DIN EN 590 51 CN ^{a)}

^{a)} Cetane Number (cetane index) = Measure of the combustion power of the diesel

Performance

Maximum speed	in km/h (mph)	183
Acceleration from 0-80 km/h (0-50 mph)	in sec.	8
Acceleration from 0-100 km/h (0-60 mph)	in sec.	12,2

Weights

Gross vehicle weight	in kg	1970
Weight in running order (with driver)	in kg	1450
Gross front axle weight	in kg	1045
Gross rear axle weight	in kg	960
Permitted roof load	in kg	75

Trailer weight

Trailer without brakes	in kg	720
Trailer with brakes, gradients up to 8%	in kg	1500
Trailer with brakes, gradients up to 12%	in kg	1400

Diesel engine 2.0 TDI CR 103 kW (140 PS)**Engine specifications**

Power output in kW (PS)	rpm	103 (140) / 4200
Maximum torque	in Nm at rpm	320/ 1750 - 2500
No. of cylinders/capacity	in cm ³	4/ 1968
Fuel		Min, diesel acc. to DIN EN 590 51 CN ^{a)}

^{a)} Cetane Number (cetane index) = Measure of the diesel combustion power.

Performance

		Manual	Automatic
Maximum speed	in km/h (mph)	201	201
Acceleration from 0-80 km/h (0-50 mph)	in sec.	6,6	6,6
Acceleration from 0-100 km/h (0-60 mph)	in sec.	9,7	9,7

Weights

		Manual	Automatic
Gross vehicle weight	in kg	1985	2000
Weight in running order (with driver)	in kg	1465	1480
Gross front axle weight	in kg	1065	1080
Gross rear axle weight	in kg	955	955
Permitted roof load	in kg	75	75

Trailer weight

		Manual	Automatic
Trailer without brakes	in kg	730	740
Trailer with brakes, gradients up to 8%	in kg	1500	1500
Trailer with brakes, gradients up to 12%	in kg	1500	1500

Dimensions and capacities

Dimensions		
Length, width	4282 mm/1768 mm	
Height at kerb weight	1546 mm	
Front and rear projection	916 mm/788 mm	
Wheelbase	2578 mm	
Turning circle	10.7 m	
Track width ^{a)}	Front	Rear
	1525 mm	1509 mm
	1539 mm	1523 mm
Capacities		
Fuel tank	55 l. Reserve 7 l.	
Windscreen washer fluid container with headlight washer	3 l/5.5 l	
Tyre pressure		
<p>Summer-grade tyres: The correct tyre pressure can be seen on the sticker on the inside of the tank flap.</p> <p>Winter tyres: The pressure of these tyres is the same as the summer tyre pressure plus 0.2 bar.</p>		

^{a)} This data will change depending on the type of wheel rim.

Index

A

- ABS 195
 - control lamp 84
- Accessories 224
- Acoustic warning 171
- Adaptive headlights 120
- Adjusting the seat belt height 28
- AFS (cornering lights) 121
- Airbag covers 36
- Airbag system 30
 - control lamp 32
 - Curtain airbags 41
 - Front airbags 34
 - side airbags 38
- Air conditioner 162
 - 2C-Climatronic 162
 - General notes 167
- Air conditioner automatic mode 164
 - 2C-Climatronic 164
- Air conditioning 159
- Air recirculation mode 166
 - 2C-Climatronic 166
 - Manual air conditioner 161
- Alarm system 107
 - Switching off 107
- Alcantara 220
- All-wheel drive 198
- Alternator 85
 - Warning lamp 85
- Anti-lock brake system 195
 - control lamp 84
- Anti-theft alarm system 107
 - Switching off 107
- Anti-theft wheel bolts 263
- Antifreeze 240
- Aquaplaning 253
- Ashtray 150
- Aspects to note before setting off 8
- ASR 195
 - Control lamp 89
- Audible warning 20
- Automatic anti-dazzle interior rear vision mirror 132
 - Activating the anti-dazzle function 132
 - Deactivating the anti-dazzle function 132
- Automatic car wash tunnel 213
- Automatic gearbox 184
 - Kick-down feature 184
- Automatic gearbox/DSG automatic gearbox 180
- Automatic lighting 117
- Automatic windscreen wiper/washer 128
- Auxiliary audio input: AUX-IN 152
- Battery 248
 - Changing 248
 - Charging 248
 - Winter conditions 247
- Before setting off 8
- Biodiesel 232
- Biodiesel fuel 232
- Bonnet 235
- Brake fluid 245
 - Changing 246
 - control lamp 66
- Brake pads 202
- Brake pedal 90
 - control lamp 202
- Brakes 85
 - Worn brake pads 85
- Brake servo 194, 202
- Brake system 245
 - Brakes 199
 - Brake servo 199
 - warning lamp 86
- Braking distance 202
- Bulb changes 272
 - General notes 272
- Bulb defect 87
 - Control lamp 87
- Buzzer 123, 171
- B 209
 - Ball coupling 209

C

- Car care
 - Exterior 213
- Catalytic converter 203
- CCS 190
- CD changer 142
- Central lock button
 - Locking 100
 - Unlocking 100
- Central locking 97
 - Automatic locking system for involuntary unlocking 99
 - Automatic speed-dependent locking and unlocking system 99
 - Emergency unlocking system 99
 - Selective unlocking system 98
 - Unlocking system 99
- Centre armrest 142
- Cetane number 232
- Changing gear
 - see* Manual gearbox 179
- Changing gear in tiptronic mode 183
- Changing the bulbs
 - Main headlight bulbs 273
 - Tail lights 276
- Changing the main headlight bulbs
 - Main beam lights 275
 - Side lights 276
 - Turn signal bulbs 273
- Changing the main headlight lamps
 - dipped lights 274
- Changing the tail lights
 - Luggage compartment lights 279
 - Rear fog light 278
 - Reverse light 278
 - Side lights 277
 - Turn signal light 278
- Changing windscreen wiper blades 243
- Chassis number 288
- Checking 248
- Checking battery electrolyte level 248
- Checking engine oil level 237
- Checklist
 - Seat upholstery 219
- Child safety 46
- Child seat
 - Categorisation in groups 48
 - Group 1 49
 - Group 2 49
 - Group 3 49
 - Groups 0 and 0+ 48
 - Safety notes 46
 - Securing 51
- Child seats 48
 - ISOFIX system 52
 - on the front passenger seat 31
 - Top Tether system 52
- Cigarette lighter 151
- Cleaning alloy wheel rims 217
- Cleaning chrome 216
- Cleaning engine compartment 218
- Cleaning steel wheel rims 217
- Cleaning windows 215
- Climatic 159
- Climatronic
 - General notes 167
- Clock 59
- Clothes hook 145
- Cockpit 55
- Compartment for on-board documentation .. 142
- control lamp 32
- Control lamps 77
- Control lighting 55
- Controls
 - electric windows 111
 - Exterior mirrors 133
 - Sliding/tilting sunroof 113
- Convenience closing
 - Sliding/tilting sunroof 114
 - Windows 113
- Convenience opening
 - Windows 113
- Coolant 240, 241
 - control lamp 66
 - Coolant level 241
 - Control lamp 82
- Coolant loss 241
- Coolant temperature
 - control lamp 82
 - Control lamp 82
 - Gauge 58
 - Safety instructions 82
- Cornering lights
 - Dynamic 121

- Correct adjustment of front seat head restraints 13
- Correct adjustment of rear seat head restraints
In-use and non-use positions 14
- Correct sitting position
front passenger 11
Incorrect sitting position 15
passenger 12
- Cruise control
Complete system deactivation 192
Control lamp 88
- Cruise control system 190
- Cruise speed 190
Control lamp 88
- Curtain airbags 41
Description 41
Operation 42
Safety notes 42
- D**
- Danger of fitting a child seat on the front passenger seat 31
- Dash panel 55
- Dash panel cleaning 222
- Daytime driving lights 118
Activating 118
Deactivating 118
- Deactivating front passenger airbag
Safety notes 45
- Deactivating the airbag
Front passenger front airbag 44
- Diesel 232
Diesel engine
Winter driving 232
Diesel engine particulate filter 204
Differential lock 197
Differential lock fault (EDL)
control lamp 89
Digital clock 59
Dipped beam headlights 116
Display (without warning or information texts) 61
Disposal
Airbags 32
Seat belt tensioners 29
Door lock cylinders 216
Door release lever 55
Doors
Childproof locks 102
control lamp 88
Drawer 143
Driver
see Correct sitting position 10, 11, 12
Driveshaft differential
XDS 196
Drive wheel traction control system (ASR) ... 195
Driving
Driving abroad 206
Economical/Environmentally friendly ... 204
With a trailer 209
Driving abroad 206
Headlights 207
Driving programmes 180
Driving safety 8
Driving with automatic gearbox/DSG automatic gearbox 181
Duplicate keys 103
Dust filter 167
Dynamic headlight range control 120
- E**
- Economical driving 204
EDL 197
control lamp 84
Electrical sockets 151
Electric power steering
Control lamp 88
Electronic differential lock 197
control lamp 84
Electronic immobiliser 90, 172
Electronic Stability Control 89, 196
description 170
Emergency braking warning 122, 194
Emergency manual locking 101
Emergency opening
Doors 107
Emission control system
control lamp 88
Engine
Running in 202
Engine compartment
Working in the engine compartment 233

- Engine coolant 240
- G 12 plus-plus 240
 - G 13 240
 - Specifications 240
- Engine fault
- Control lamp 83
- Engine management
- control lamp 83
- Engine oil 236
- Changing 239
 - Checking engine oil level 237
 - Oil properties 237
 - Specifications 236
 - Topping up 238
- Engine oil dipstick 237
- Engine oil pressure
- control lamp 66, 87
- Environment 204
- Environmental friendliness 206
- Environmentally friendly driving 204
- Environmental tip
- Avoiding pollution 227
- ESC 89, 170, 196
- see also* Electronic Stability Control 170
- Example of menu use
- Program a speed limit warning 69
 - To activate and deactivate the speed limit warning 69
- Example of the use of the menus
- Open the Configuration menu with the MFI lever 68
 - Open the Configuration menu with the steering wheel controls 69
- Examples of menu use
- Open the main menu 68
 - Open the winter tyres menu 69
 - To close the winter tyres menu 69
- Exhaust gas purification system 203
- Exterior mirrors 215
- ## F
- Fastening rings 18
- Fire extinguisher 153
- First-aid kit 153
- Flexible service interval display 62
- Floor mats 16
- Fog lights 116
- Fog lights with cornering function 121
- Folding table 143
- Folding the seat backrests down 141
- Front airbags 34
- Description 34
 - Operation 35
 - Safety notes 37
- Front drinks holders 146
- Front passenger airbag deactivation 44
- Front reading lights 126
- Front seat adjustment
- Lumbar support 138
- Fuel
- Diesel 232
 - Petrol 231
- fuel consumption 204
- Fuel consumption 288
- Fuel level
- Indicator 58
- Fuel reserve 81
- Warning message 67
- Fuel tank
- see* Fuel reserve 81
- Fuel Tank
- Opening the fuel tank flap 226
- Fuel: save 204
- Fuses 268
- ## G
- Gear shift pattern 179
- General overview of the engine compartment 291
- Glove compartment 142
- Glow plug system 173
- Control lamp 83
- ## H
- Handbrake 185
- Control lamp 87
 - Warning lamp 185
- Hazard warning lights 121
- HBA 194
- Headlight flashers 123
- Headlight range control 120
- Headlights
- Driving abroad 207
 - Fog lights 116
 - Headlight washer 131

- Head restraints
 Adjusting 136, 137
 Adjustment of the head restraint angle .. 137
 Removing 137
- Heated front seats 139
- Heated rear window
 2C-Climatronic 163
 Heating element wires 216
- Heating 157
- High pressure cleaners 214
- Hill-start aid 186
- Horn 55
- How to jump start description 282
- Hydraulic Brake Assist 194
- I**
- Identification number 288
- Identification plate 288
- Ignition key 171
- Ignition lock 171
- Information in the multifunction display
 Memory displays 64
- Information messages in the display 66
- Instrument and switch lighting 120
- Instrument lighting 55
- Instrument panel menu
 Lights and visibility menu 75
- Instrument panel menus
 Configuration menu 73
 Example of menu use 68
- Main menu 68
- Vehicle status menu 73
- Instruments 57
- Interior front light, type 1 124
- Interior front light, type 2 125
- Interior rear vision mirror 132
- Interval wipe, windscreen 128
- ISOFIX system 52
- J**
- Jump-starting 281
- Jump leads 281
- K**
- Keys 103
- L**
- Lights 116
- Load compartment in the luggage compartment
see Loading the luggage compartment ... 17
- Loading the luggage compartment 17
- Locks 216
- LPG 60, 175, 228
- LPG system
 Driving 175
 Filler neck adapter 230
 Level indicator 60
 Refuelling 228
- Luggage compartment 154
see also Loading the luggage compartment 17
- Luggage compartment net 145
- M**
- Main beam 116, 123
- Main beam headlights
 control lamp 83
- Main headlight bulbs 273
- Maintenance
 Airbags 32
- Maintenance and cleaning 212
- Manual gearbox 179
- Manual mode
 2C-Climatronic 165
- MEDIA-IN connector 153
- MFI 63
- Mirrors
 Exterior mirrors 133
 Interior rear vision mirror 132
 Vanity mirrors 127
- Mobile phones and two-way radios 225
- Multi-purpose mobile storage compartment
 Closing 149
 Functions 149
 Installing 148
 Opening 149
 Removing 148
- Multi-purpose mobile storage compartment* 149
- Multifunction display 63

N

Number of seats 19

O

Observations 206

Octane number 231

Odometer 62

Oil 236

Oil change 239

Oil properties 237

One-touch opening and closing

Electric windows 112

Opening and locking 109

Outside temperature indicator 65

Overview

control lamps 79

control lamps 77

Dash panel 55

Instruments 57

warning lamps 79

Warning lamps 77

P

Paintwork

Polishing 215

Parking 185

Parking aid acoustic system 187

Parking lights 123

Parking system 187

Parking system plus 188

Passenger

see Correct sitting position 10, 11, 12

Pedals 16

Petrol 231

Driving abroad 206

Petrol additives 232

Physical principles of a frontal collision 21

Plastic parts 215

Plastic parts cleaning 222

Pollen filter 167

Pollution filter 167

Power steering 200

Products for vehicle maintenance 212

R

Radio frequency remote control 105

Changing the battery 106

Radio navigation controls on the steering

wheel

Audio + telephone version 95

Rain sensor 130

Rear cup holder

Armrest 147

Rear fog light

control lamp 82, 116

Control lamp 116

Rear interior lights 126

Rear lid 109

control lamp 88

Emergency opening 110

Rear reading lights 126

Rear seats 140

Rear shelf

Storage compartment 155

Rear window automatic wiper/washer 131

Rear window wiper 131

Recommended gear display 62

Refuelling 226

Registration light 280

Remote control key

Buttons 105

Synchronising 106

Removing and fitting the wheel 265

Repairs

Airbags 32

Replacement keys 103

Replacement of parts 224

Rev counter 59

Reverse gear

Manual gearbox 179

Roll-back function

Sliding/tilting sunroof 115

Windows 112

Roof aerial 225

Roof rack 155

Roof storage compartment 144

Rubber seals 216

Run-flat tyres 254

Running in

Engine 202

S

- Safe- security system 98
- Safe driving 7
- Safety 8
- Safety equipment 7
- Safety instructions
 - Coolant temperature 82
- Safety notes
 - Airbags 32
 - Curtain airbags 42
 - Deactivating front passenger airbag 45
 - Front airbags 37
 - Seat belt tensioners 29
 - Side airbags 40
 - Using child seats 46
 - Using seat belts 23
- Seals 216
- Seat adjustment 135, 138, 140
- Seat belt cleaning 223
- Seat belt control lamp 19
- Seat belt position
 - Pregnant women 27
 - Seat belts 26
- Seat belt protection 23
- Seat belt release 27
- Seat belts 19
 - Adjustment 25
 - control lamp 19
 - Incorrectly fastened 28
 - Not worn 22
 - Safety notes 23
- Seat belt tensioner
 - control lamp 32
- Seat belt tensioners 29
- Seat heating 139
- Seat upholstery
 - Alcantara 220
 - Checklist 219
 - cleaning Alcantara 220
 - Cleaning and maintenance of natural leather 221
 - cleaning the trim fabric 220
 - synthetic leather 222
 - Selective opening 98
 - Selector lever locking 181
 - Selector lever positions 180
 - servotronic 200
 - Side airbags 38
 - Description 38
 - Operation 39
 - Safety notes 40
 - Side lights 116
 - Sitting position
 - driver 10
 - Sitting position, occupants 10
 - Sliding/tilting sunroof 113
 - Snow chains 257, 290
 - Soot accumulation in the diesel engine particulate filter
 - Indicator 83
 - Spare parts 224
 - Spare wheel 259
 - Start-Stop
 - Activating and deactivating 177
 - Function 176
 - Starting petrol engines 172, 173
 - Starting the engine 172, 173
 - After the fuel tank has been run dry 173
 - Steam jets 214
 - Steering 169
 - Steering lock 171
 - Steering wheel audio controls
 - Audio version 91
 - Audio + telephone version 91
 - Steering wheel height adjustment 169
 - Storage compartment
 - Centre armrest 142
 - Front passenger side 142
 - Front seats 143
 - Lock 155
 - Other storage compartments 145
 - Storage in the luggage compartment 144
 - Sun visor
 - Sliding/tilting sunroof 114
 - Sun visors 127
 - Switch
 - Hazard warning lights 121
 - Light switch 116
 - Switches
 - electric windows 111
 - Switching off the engine 174

T

Tail lights	276
Tank	
Fuel level	58
Reserve indicator	58
Tank capacity	58
Technical modifications	224
The danger of not using the seat belt	22
Tightening torque of wheel bolts	290
Tilting sunroof	113
Tools	259
Top Tether system	52
Tow-starting	284
Towing	284
Towing a trailer	289
Towing bracket	209
Towing bracket, fitting	210
Towline anchorage	284
Towline anchorages	286
Tow starting	
General notes	284
Traction control system (ASR)	
control lamp	89
Trailer	
Trailer towing	208
Trailer turn signals	
control lamp	123
Trailer weights	289
Turn signals	123
control lamp	83, 123
Tyre-Mobility-System (Tyre repair kit)	266

Tyre Mobility-System (Tyre repair kit)	260
Tyre pressure	250
Loss	252
Tyre pressure control lamp	85
Tyre pressure monitoring	251
Tyre pressures	290
Tyre repair kit	260, 266
Tyres and wheels	
Dimensions	255
Tyres tread depth	253
Tyres useful life	252
Tyres with directional tread pattern	250

U

Underbody protection	217
Unlocking and locking	
Personalisation	101
Upholstery	
Treating your upholstery	219

V

Vehicle battery	247
Vehicle data	288
Vehicle identification data	288
Vehicle identification number	288
Vehicle maintenance	
electrically adjustable seats	220
heated seats	220
natural leather	221
non-electrically adjustable seats	220

seats with airbag components	220
seats without airbag components	220
synthetic leather	222
Treating your upholstery	219
trim fabrics	220
unheated seats	220
Vehicle modifications	224
Vehicle paintwork	
Maintenance	215
Products for vehicle maintenance	212
Vehicle tools	
Storage	259
Vehicle washing	213
Ventilation slits	18
Volumetric sensor	
Activation	107
Deactivation	107

W

Warning lamps	77
Warning messages	
Red	66, 80
Yellow	66, 80
Warning messages in the display	66
Warning symbols	80
Warning triangle	153
Washer fluid	242
Washing by hand	213
Washing the vehicle	213
Washing with high pressure cleaners	214

Water	
Warning message	67
Water in the windscreen washer tank	242
Wear indicators	253
Wearing suitable shoes	16
Wheel bolts	263, 290
Tightening torque	256
Wheel change	261
Wheels	250, 290
Wheel trims	262
Why assume the correct sitting position?	30
Why should head restraints be correctly adjusted?	13
Why wear seat belts?	19, 21, 30
Windows	111
Windscreen washer fluid	
Control lamp	84
Windscreen wiper blades	
Cleaning	216
Windscreen wipers	128
Changing blades	243
Changing the rear wiper blade	244
Winter driving	
Diesel engine	232
Winter tyres	257
Wooden trim cleaning	222
Working in the engine compartment	233

SEAT S.A. is permanently concerned about continuous development of its types and models. For this reason we ask you to understand, that at any given time, changes regarding shape, equipment and technique may take place on the car delivered. For this reason no right at all may derive based on the data, drawings and descriptions in this current handbook.

All texts, illustrations and standards in this handbook are based on the status of information at the time of printing. Except for error or omission, the information included in the current handbook is valid as of the date of closing print.

Re-printing, copying or translating, whether total or partial is not allowed unless SEAT allows it in written form.

SEAT reserves all rights in accordance with the "Copyright" Act.

All rights on changes are reserved.

 This paper has been manufactured using bleached non-chlorine cellulose.

© SEAT S.A. - Reprint: 15.07.12

Inglés 5P0012003FN (07.12) (GT9)



5P0012003FN

