



Alhambra

Owner's manual

Vehicle identification data

Model:
Vehicle Registration:
Vehicle identification number:
Date of vehicle registration or vehicle delivery:
SEAT Official Service:
Service advisor:
Telephone:

Confirmation of receipt of documentation and vehicle keys

The following items were delivered with the vehicle:	YES	NO
On-board documentation	<input type="checkbox"/>	<input type="checkbox"/>
First key	<input type="checkbox"/>	<input type="checkbox"/>
Second key	<input type="checkbox"/>	<input type="checkbox"/>
Correct working order of all keys was checked	<input type="checkbox"/>	<input type="checkbox"/>
Location:		
Date:		
Signature of owner:		

Introduction

Thank you for your trust choosing a SEAT vehicle.

With your new SEAT, you will be able to enjoy a vehicle with state-of-the-art technology and top quality features.

We recommend reading this Instruction Manual carefully to learn more about your vehicle so you can enjoy all its benefits in your daily driving.

Information about handling is complemented with instructions regarding the operation and maintenance of the vehicle in order to ensure its safety and maintain its value. Moreover, we want to give you valuable advice and tips to drive your vehicle efficiently and respecting the environment.

We wish you safe and enjoyable motoring.

SEAT, S.A.

WARNING

Read and always observe safety information concerning the passenger's front airbag »» page 31, Fitting and using child seats.

About this manual

This instruction manual is valid for all variants and versions of your SEAT model. It describes all equipment and models without specifying whether they are optional equipment or model variants. As a result, equipment not fitted to your vehicle or only available in certain countries may be described. Find out about your vehicle's equipment in the documentation supplied with it and please contact your SEAT Official SEAT Service if you require more detailed information.

All information provided in instruction manual corresponds to the information available at the time of going to press. As the vehicle is under continuous development, it may have differences to the data included in this manual. For this reason, no claims can be made in the event of mismatching data, illustrations and descriptions.

Ensure that the on-board documentation is kept in the vehicle at all times if you sell it or lend it to third parties. In addition, SEAT recommends resetting the infotainment system to factory settings to delete all personal data.

Some details on the **drawings** may vary from its vehicle and must be interpreted as a standard representation.

The **direction indicators** (left, right, forwards, backwards) in this manual refer to the travel

direction of the vehicle unless otherwise stated.

This instruction manual has been written for **left-hand drive vehicles**. In right-hand drive vehicles, the arrangement of the controls differs partly from that shown in the illustrations or described in the texts.

Technical modifications to the vehicle or safety-critical issues that have arisen since the time of going to press will be included in a supplement to the on-board documentation.

© **Trademarks** are marked with ®. The absence of this symbol does not guarantee that the term is not a trademark.

>> It indicates that the section continues on the next page.

You can access the information in this manual using:

- Thematic table of contents that follows the manual's general chapter structure.
- Visual table of contents that uses graphics to indicate the pages containing "essential" information, which is detailed in the corresponding chapters.
- Alphabetical index with many terms and synonyms to help you find information.

WARNING

Texts after this symbol contain information about safety and warn you about possible accident or injury risks.

CAUTION

Texts after this symbol indicate possible damage to the vehicle.

For the sake of the environment

Texts after this symbol contain information about the protection of the environment.

Note

Texts after this symbol contain additional information.

Digital instruction manual

The digital version of the manual can be found on SEAT's official website:



- scan the QR code »» Fig. 1
- **OR** enter the following address in the navigator website:

<http://www.seat.com/owners/your-seat/manuals-offline.html>

and select your vehicle.

Related videos

The operation of some of the vehicle's features can be shown as an instruction video:



- scan the QR code »» Fig. 2
- **OR** enter the following address in the navigator website:

<http://www.seat.com/owners/your-seat/manuals-offline.html>

choose your vehicle and then "Multimedia".

Note

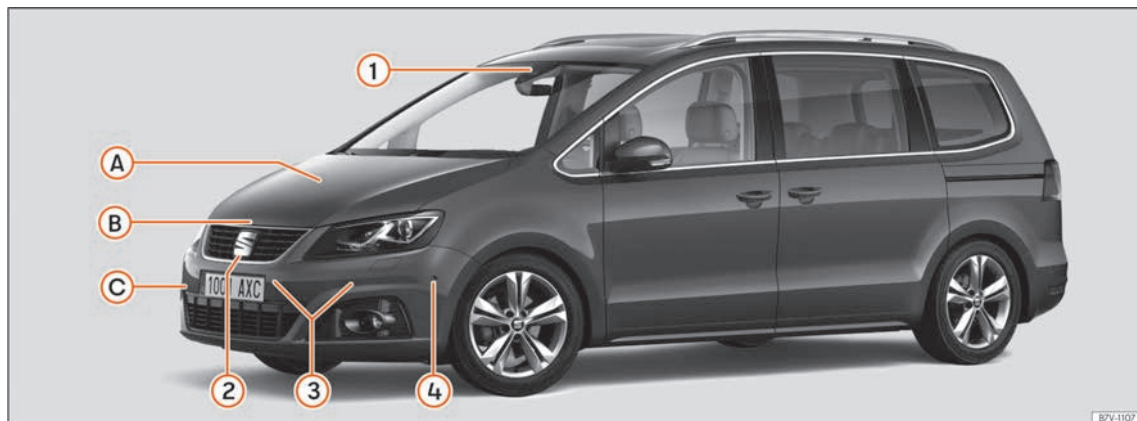
Video instructions are only available in certain languages.

Table of Contents

General views of the vehicle	7		
Exterior view	7		
Exterior view	8		
Overview (left hand drive)	9		
Interior view	10		
Safety	11		
Safe driving	11		
Advice about driving	11		
Correct sitting position of vehicle occupants	12		
Pedal area	15		
Seat belts	15		
The whys and wherefores of seat belts	15		
How to properly adjust your seat belt	18		
Seat belt tensioners	21		
Airbag system	22		
Brief introduction	22		
Operation of the airbags	24		
Transporting children safely	30		
Child safety	30		
Integrated child seat	36		
Emergencies	40		
Self-help	40		
Emergency equipment	40		
Tyre repairs	42		
Changing a wheel	45		
Changing the windscreen wiper blades	50		
		Jump start	51
		Tow start and towing	53
		Fuses and bulbs	58
		Fuses	58
		Changing bulbs	60
		Operation	69
		Controls and displays	69
		Interior view	69
		Instruments and warning/control lamps	70
		Instrument panel	70
		Using the instrument panel	85
		Control lamps	87
		Multifunction steering wheel	89
		Three button unit in the roof	91
		Opening and closing	93
		Set of vehicle keys	93
		Central locking	95
		Anti-theft alarm system	101
		Doors	103
		Sliding doors	105
		Rear lid	107
		Window controls	113
		Sunroof	114
		Lights	117
		Vehicle lighting	117
		Interior lights	124
		Visibility	125
		Windscreen wiper and rear window wiper systems	125
		Mirrors	128
		Sun protection	130
		Seats and headrests	131
		Adjusting seats	131
		Headrest	133
		Seat functions	135
		Transport and practical equipment	140
		Storing objects	140
		Luggage compartment	141
		Net partition	149
		Roof carrier	150
		Storage compartment	152
		Drink holder	157
		Power sockets	158
		Air conditioning	161
		Heating, ventilation and cooling	161
		Auxiliary heating (additional heating)	168
		Infotainment system	172
		Introduction	172
		Safety warnings	172
		Overview of the unit	174
		General instructions for use	177
		Voice control	183
		Connectivity	186
		Full Link	186
		Operating modes	194
		Radio	194
		Media	203
		Navigation	215
		Telephone	226
		Multimedia	239
		Driving	241
		Start and driving	241
		Starting and stopping the engine	241
		Start-Stop system	245
		Manual gearbox	247

Automatic gearbox/DSG automatic gearbox	248	Engine management and emissions control system	314
Gear-change recommendation	253	Engine compartment	315
Steering	253	Engine oil	318
Dynamic chassis control (DCC)	255	Cooling system	321
Driving tips	255	Brake fluid	323
Driver assistance systems	259	Windscreen washer reservoir	324
General notes	259	12-volt battery	325
Drive assist sensors and cameras	260	Wheels	328
Cruise control system (CCS)	262	Wheels and tyres	328
Emergency brake assistance system (Front Assist)	265	Tyre pressure monitor system	334
ACC - Adaptive Cruise Control	268	Maintenance	337
Lane Assist	274	SEAT Maintenance Programme	337
Using the blind spot detector (BSD) with parking assistant (RCTA)	277	Service intervals	337
Braking and parking	282	Additional service offers	339
Braking system	282	Warranty	340
Stabilisation and brake assistance systems	287	Vehicle maintenance	340
Parking	290	Maintenance and cleaning	340
Help with parking and manoeuvring	290	Accessories and modifications to the vehicle	345
Park Assist system	290	Accessories, spare parts and repair work	345
Parking aid	294	Information for the user	348
Reverse Assist (Rear View Camera)	297	Information for the user	348
Towing bracket device	301	Information stored by the control units	348
Trailer mode	301	Other important information	349
Electrically unlocking trailer hook	308	Radioelectrical equipment	351
Retrofitting a towing bracket	310	Technical data	357
Practical tips	311	Indications about the technical data	357
Checking and refilling levels	311	Important information	357
Refuelling	311	Index	361
Fuel types	312		

Exterior view



Driving assistance sensors »» page 259

- ① Front multifunction camera
- ② Front radar
- ③ Parking aid sensors
- ④ Park assist sensor

A Levels control

- Oil »» page 318
- Brake fluid »» page 323
- Battery »» page 325

B Bonnet

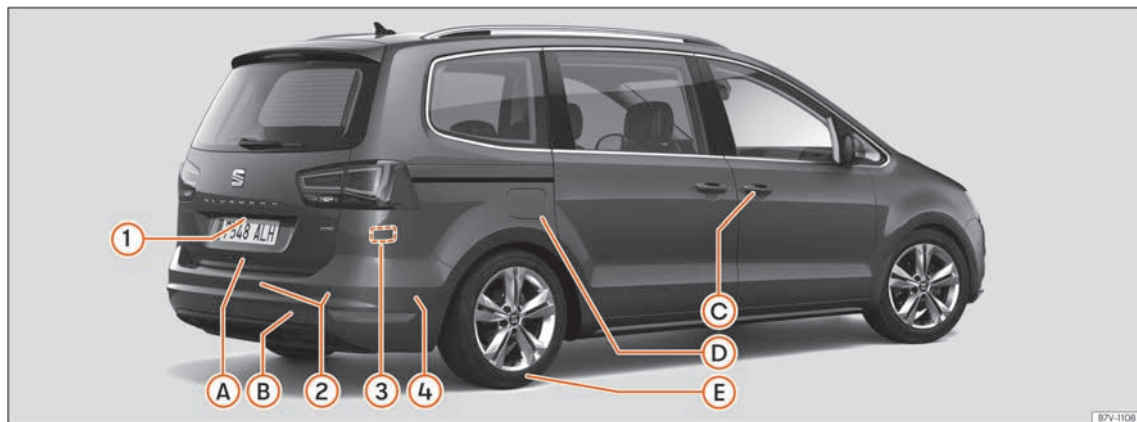
- Unlocking lever »» page 316
- Open/close »» page 316

C Towing the vehicle

- Towline anchorage »» page 56

- Tow-start »» page 54

Exterior view



Driving assistance sensors » page 259

- ① Rear view camera
- ② Parking aid sensors
- ③ Rear radars
- ④ Park assist sensor

A Rear lid

- Opening from outside
- Emergency opening » page 112

B Towing the vehicle

- Towline anchorage » page 56
- Tow-start » page 54

C Opening and closing

- Doors » page 103
- Central locking » page 95
- Emergency lock » page 104

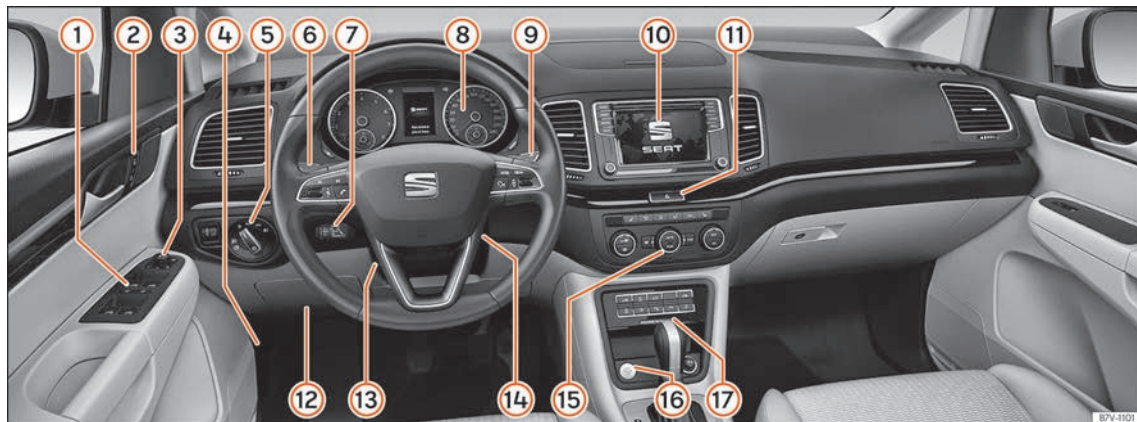
D Fuel tank

- Fuel capacity » page 357
- Open/Close cap » page 311

E Action in the event of a puncture

- Anti-puncture kit » page 42
- Wheel change » page 45

Overview (left hand drive)



- | | | |
|-----------------------------------------------|------------------------------------------------------------------------------------|-----------------------------------------------------------|
| ① Electric windows »» page 113 | ⑨ Wipers and rear window wiper »» page 125
Driver information system »» page 85 | ⑯ Starter button »» page 241 |
| ② Central locking »» page 95 | ⑩ Infotainment system (factory fitted) »» page 172 | ⑰ Front passenger airbag disconnection display »» page 26 |
| ③ Exterior mirror adjustment »» page 128 | ⑪ Hazard warning lights »» page 122 | |
| ④ Open bonnet lever »» page 316 | ⑫ Fuses »» page 58 | |
| ⑤ Headlight switch »» page 117 | ⑬ Steering wheel adjustment »» page 14 | |
| ⑥ Turn signal and main beam lever »» page 119 | ⑭ Ignition lock »» page 241 | |
| ⑦ Cruise control »» page 262 | ⑮ Air conditioning »» page 161 | |
| ⑧ Warning lamps »» page 87 | | |

Interior view



① Access to the third row of seats
»» page 137

② Seat belts »» page 15

③ Isofix anchors »» page 32

④ Headrest adjustment »» page 133

⑤ Panoramic roof »» page 114

⑥ Interior mirror »» page 128

⑦ Disconnecting the front passenger front
airbag »» page 26

⑧ Armrest »» page 139

⑨ Seat adjustment »» page 131

Safety

Safe driving

Advice about driving

Safety first!

WARNING

- This manual contains important information about the operation of the vehicle, both for the driver and the passengers. The other sections of the on-board documentation also contain further information that you should be aware of for your own safety and for the safety of your passengers.
- Ensure that the on-board documentation is kept in the vehicle at all times. This is especially important when lending or selling the vehicle to another person.

Before driving

For your own safety and the safety of your passengers, always note the following points before every trip:

- Make sure that the vehicle's lights and turn signals are working properly.
- Check tyre pressure.

- Ensure that all windows provide a clear and good view of the surroundings.
- Make sure all luggage is secured »» page 140.
- Make sure that no objects can interfere with the pedals.
- Adjust front seat, headrest and mirrors properly according to your size.
- Ensure that the passengers in the rear seats always have the headrests in the in-use position »» page 133.
- Instruct passengers to adjust the headrests according to their height.
- Protect children with appropriate child seats and properly applied seat belts »» page 30.
- Assume the correct sitting position. Instruct your passengers also to assume a proper sitting position »» page 12.
- Fasten your seat belt securely. Instruct your passengers also to fasten their seat belts properly »» page 15.

Factors influencing safety

As a driver, you are responsible for yourself and your passengers.

- Always pay attention to traffic and do not get distracted by passengers or telephone calls.
- Never drive when your driving ability is impaired (e.g. by medication, alcohol, drugs).
- Observe traffic laws and speed limits.
- Always reduce your speed as appropriate for road, traffic and weather conditions.
- When travelling long distances, take breaks regularly - at least every two hours.
- If possible, avoid driving when you are tired or stressed.

WARNING

Driving under the influence of alcohol, drugs, medication or narcotics may result in severe accidents and even loss of life.

- Alcohol, drugs, medication and narcotics may significantly alter perception, affect reaction times and safety while driving, which could result in the loss of control of the vehicle.

Safety equipment

Never put your safety or the safety of your passengers in danger. In the event of an accident, the safety equipment may reduce the »

risk of injury. The following points cover part of the safety equipment in your SEAT¹⁾:

- three-point seat belts,
- belt tensioners for the front and rear side seats,
- belt tensioners in the front seats and outside seats in the second row of seats
- Belt height adjustment for the front seats
- front airbags,
- knee airbags,
- side airbags in the front seat backrests,
- side airbags in the rear seat backrests,
- head-protection airbags,
- "ISOFIX" anchor points for "ISOFIX" rear child seat system
- height-adjustable front headrests,
- rear headrests with in-use position and non-use position,
- adjustable steering column.

The safety equipment mentioned above works together to provide you and your passengers with the best possible protection in the event of an accident. However, these safety systems can only be effective if you and your passengers are sitting in a correct position and use this equipment properly.

Safety is everyone's business!

Correct sitting position of vehicle occupants

Correct position on the seat

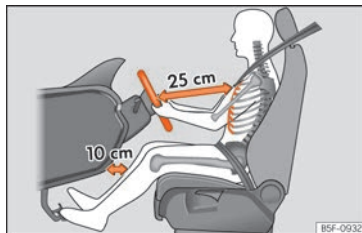


Fig. 3 The correct distance between the driver and the steering wheel must be at least 25 cm (10 inches).

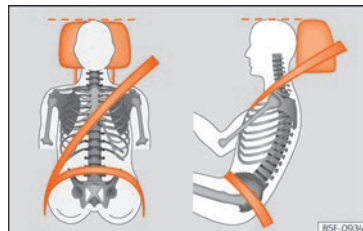


Fig. 4 Correct belt web and headrest positions

The correct sitting positions for the driver and passengers are shown below.

If your physical constitution prevents you from maintaining the correct sitting position, contact a specialised workshop for help with any special devices. The seat belt and airbag can only provide optimum protection if a correct sitting position is adopted. SEAT recommends taking your car in for technical service.

For your own safety and to reduce the risk of injury in the event of an accident or sudden braking or manoeuvre, SEAT recommend the following positions:

Valid for all vehicle occupants:

- Adjust the headrest so that its upper edge is at the same level as the top of your head, or

¹⁾ Depending on the version/market.

as close as possible to the same level as the top of your head and under no circumstances below eye level. Keep the back of your neck as close as possible to the headrest »» Fig. 4.

- Short people must lower the headrest completely, even if your head is below its upper edge.
- Tall people must raise the headrest completely.
- Always keep your feet in the footwell while the vehicle is in motion.
- Adjust and fasten your seat belt correctly »» page 18.

The following also applies to the driver:

- Move the seat backrest to an almost upright position so that your back rests completely against it.
- Move the steering wheel so it is at least 25 cm (10 inches) away from the sternum »» Fig. 3 and you can hold it with both hands on both sides, on the outer part, with your arms slightly bent.
- The steering wheel must always point towards the chest and never towards the face.
- Move the seat in such a way that you can step on the pedals with your knees slightly bent and with a distance between the knees and the dashboard of at least 10 cm (4 inches) »» Fig. 3.

- Adjust the height of the seat so that you can reach the top of the steering wheel.
- Always keep both feet in the footwell so that you have the vehicle under control at all times.

For the passenger, the following applies:

- Move the seat backrest to an almost upright position so that your back rests completely against it.
- Move the seat as far back as possible (minimum 25 cm between the chest and the dashboard check translation). If you are sitting closer than 25 cm, the airbag system cannot protect you properly.

Number of seats

The vehicle has **5** or **7** seats, depending on the features. All seats are equipped with a safety belt.

	5 seats	7 seats
Seats in the front	2	2
Seats in the second row	3	3
Seats in the third row	-	2

⚠ WARNING

Sitting in an incorrect position may increase the risk of severe or lethal injuries in the event of sudden braking or manoeuvring, in case of collision or accident and if the airbags deploy.

- Before starting the car, all passengers must be sitting in a correct position and stay like that for the entire journey. This also applies to a correct use of the seat belt.
- The maximum amount of people in the vehicle is the same as the amount of seats with seat belts.
- For children, always use a certified protection system, certified and suited for their weight and height »» page 30.
- While driving, always keep your feet in the footwell. Never place them over the seat or the dashboard, for example, or outside the window. Otherwise the airbag and seat belt may offer insufficient protection and also increase the risk of injury in the event of an accident.

Risks of sitting in an incorrect position

If seat belts are worn incorrectly or not at all, the risk of severe or lethal injuries increases. Seat belts can provide optimal protection only if the belt web is properly worn. Incorrect sitting positions substantially reduce the »

protective function of seat belts and, therefore, increase the risk of severe or even lethal injuries. The risk of severe or fatal injuries is especially heightened when a deploying airbag strikes a vehicle occupant who has assumed an incorrect sitting position. The driver is responsible for all people, particularly children, inside the vehicle.

The following list contains examples of incorrect sitting positions that could be dangerous for all vehicle occupants.

When the vehicle is in motion:

- Never stand in the vehicle.
- Never stand on the seats.
- Never kneel on the seats.
- Never tilt your seat backrest too far to the rear.
- Never lean against the dash panel.
- Never lie on the rear seats.
- Never sit on the front edge of a seat.
- Never sit sideways.
- Never lean out of a window.
- Never put your feet out of a window.
- Never put your feet on the dash panel.
- Never place your feet on the bench or on the backrest of the seat.
- Never travel in a footwell.
- Never sit on the armrests.

- Never travel without wearing the seat belt.
- Never travel in the luggage compartment.

WARNING

Sitting in an incorrect position increases the risk of severe or fatal injuries in the event of accidents and sudden braking or manoeuvres.

- All occupants must sit correctly during the journey and wear the seat belt correctly.
- Occupants of the vehicle that are not sitting correctly, not wearing the seat belt or are not at a proper distance of the airbag risk suffering very serious or lethal injuries, especially if the airbags deploy and strike them.

Steering wheel position adjustment

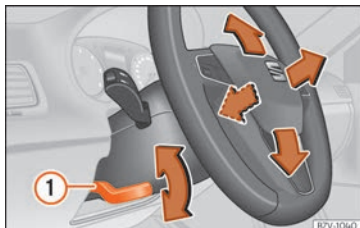


Fig. 5 Lever in the lower left side of the steering column.

Adjust the steering wheel before your trip and only when the vehicle is stationary.

- Pull the **»»» Fig. 5 ①** lever down, move the steering wheel to the desired position and lift the lever back up until it locks.

WARNING

Incorrect use of the steering wheel adjustment function and an incorrect adjustment of the steering wheel can result in severe or fatal injury.


- After adjusting the steering column, push the lever **»»» Fig. 5 ①** firmly upwards to ensure the steering wheel does not accidentally change position while driving.

- Never adjust the steering wheel while the vehicle is in motion. If you need to adjust the steering wheel while the vehicle is in motion, stop safely and make the proper adjustment.
- The adjusted steering wheel should be facing your chest and not your face so as not to hinder the driver's front airbag protection in the event of an accident.
- When driving, always hold the steering wheel with both hands on the outside of the ring at the 9 o'clock and 3 o'clock positions to reduce injuries when the driver's front airbag deploys.
- Never hold the steering wheel at the 12 o'clock position or in any other manner (e.g. in the centre of the steering wheel). In such cases, if the driver's airbag deploys, you may sustain injuries to your arms, hands and head.

Pedal area

Pedals

- Ensure that you can always press the accelerator, brake and clutch pedals unimpeded to the floor.
- Ensure that the pedals can return unimpeded to their initial positions.

- Ensure that the floor mats are securely fastened during the trip and do not obstruct the pedals »» .

Only use floor mats which leave the pedals clear and which are secured to prevent them from slipping. You can obtain suitable floor mats from a specialised dealership. Fasteners for floor mats are fitted in the footwells.

If a brake circuit fails, the brake pedal must be pressed down thoroughly in order to stop the vehicle.

Wear suitable footwear

Always wear shoes which support your feet properly and give you a good feeling for the pedals.

WARNING

- Restricting pedal operation can lead to critical situations while driving.
- Never lay or fit floor mats or other floor coverings over the original floor mats. This would reduce the pedal area and could obstruct the pedals. Risk of accident.
- Never place objects in the driver footwell. An object could move into the pedal area and impair pedal operation.

Seat belts

The whys and wherefores of seat belts

Control lamps



Lights up or flashes


Driver or passenger has not fastened seat belt.

Objects on the front passenger seat.
Remove the objects from the front passenger seat and store them safely.


The control lamp  lights up to remind the driver to fasten their seat belt.

Before starting the vehicle:

- Fasten your seat belt securely.
- Instruct your passengers to fasten their seat belts properly before driving off.
- Protect children by using a child seat according to the child's height and weight »» page 30.

When starting to drive, if the vehicle's speed exceeds approx. 25 km/h (15 mph) and the seat belts are not fastened or are unfastened while driving, a warning sound will be heard for a few seconds. The warning light will also flash .






The lamp  goes out when the driver and passenger seat belts are fastened with the ignition switched on.

Rear seat belts fastened display



Fig. 6 Example of seat belt status display for the rear seats (here, a 7-seat vehicle) on the instrument panel.: upper part, second row; lower part, third row.

Depending on the model version, when the ignition is switched on, the seat belt status display  **Fig. 6** on the instrument panel informs the driver whether the passengers in the rear seats have fastened their seat belts.

-  It indicates that the corresponding seat is empty.
-  Indicates that the seat is occupied and the occupant is wearing the seat belt.

The seat belt status flashes for a maximum of 30 seconds when a seat belt in the rear seats is unfastened while the vehicle is in motion. An audible warning will also be heard if the vehicle is travelling at over 25 km/h (15 mph).

The rear seat display can be enabled or disabled by a technical service centre.

If a seat belt is fastened or unfastened while driving in some of the rear seats, the seat belt status is displayed for approximately 30 seconds. The indication can be hidden by pressing the **0.0/SET** button on the dash panel.

The protective function of seat belts



Fig. 7 Drivers with properly worn seat belts will not be thrown forward in the event of sudden braking.

Properly worn seat belts hold the occupants in the proper position. They also help prevent

uncontrolled movements that may result in serious injury and reduce the risk of being thrown out of the vehicle in case of an accident.

Vehicle occupants wearing their seat belts correctly benefit greatly from the ability of the belts to absorb kinetic energy. In addition, the front part of your vehicle and other passive safety features (such as the airbag system) are designed to absorb the kinetic energy released in a collision. Taken together, all these features reduce the releasing kinetic energy and consequently, the risk of injury. This is why it is so important to fasten seat belts before every trip, even when "just driving around the corner".

Ensure that your passengers wear their seat belts as well. Accident statistics have shown that wearing seat belts is an effective means of substantially reducing the risk of injury and improving the chances of survival when involved in a serious accident. Furthermore, properly worn seat belts improve the protection provided by airbags in the event of an accident. For this reason, wearing a seat belt is required by law in most countries.

Although your vehicle is equipped with airbags, the seat belts must be fastened and worn. The front airbags, for example, are only triggered in some cases of head-on collision. The front airbags will not be triggered during minor frontal or side collisions, rear-end collisions, overturns or accidents in which the

airbag trigger threshold value in the control unit is not exceeded.

Important safety instructions for the use of seat belts

- Always wear the seat belt as described in this section.
- Ensure that the seat belts can be fastened at all times and are not damaged.

⚠ WARNING

- If seat belts are worn incorrectly or not at all, the risk of severe injuries increases. The optimal protection from seat belts can be achieved only if you use them properly.
- Never allow two passengers (even children) to share the same seat belt.
- Never unbuckle a seat belt while the vehicle is in motion. Risk of fatal injury.
- The seat belt should never lie on hard or fragile objects (such as glasses or pens, etc.) because this can cause injuries.
- Do not allow the seat belt to be damaged or jammed, or to rub on any sharp edges.
- Never wear the seat belt under the arm or in any other incorrect position.
- Bulky and unfastened clothing (such as an overcoat over a sweater) impairs the proper fit and function of the seat belts, reducing their capacity to protect.

- The slot in the seat belt buckle must not be blocked with paper or other objects, as this can prevent the latch plate from engaging securely.
- Never use seat belt clips, fastening rings or similar items to alter the position of the belt webbing.
- Frayed or torn seat belts or damage to the connections, belt retractors or parts of the buckle could cause severe injuries in the event of an accident. Therefore, you must check the condition of all seat belts at regular intervals.
- Seat belts which have been worn in an accident and have been stretched must be replaced by a specialised workshop. Renewal may be necessary even if there is no apparent damage. The belt anchorage should also be checked.
- Do not attempt to repair a damaged seat belt yourself. The seat belts must not be removed or modified in any way.
- The belts must be kept clean, otherwise the retractors may not work properly.

Head-on collisions and the laws of physics



Fig. 8 A driver not wearing a seat belt is thrown forward violently.



Fig. 9 The unbelted passenger in the rear seat is thrown forward violently, hitting the driver who is wearing a seat belt.

The effects of the laws of physics in the case of a head-on collision are easy to explain: the »

moment a vehicle starts moving, a type of energy called “kinetic energy” starts acting on both the vehicle and its passengers.

The amount of “kinetic energy” depends on the speed of the vehicle and on the weight of the vehicle and of its passengers. The higher they are, the more energy there is to be “absorbed” in the event of an accident.

The most significant factor, however, is the speed of the vehicle. If the speed doubles from 25 km/h (15 mph) to 50 km/h (30 mph), for example, the corresponding kinetic energy is multiplied by four.

Given that the passengers of the vehicle in our example do not have their seat belts fastened, in the event of a collision the entire amount of the passengers' kinetic energy will be only absorbed by the mentioned impact.

Even at speeds of 30 km/h (19 mph) to 50 km/h (30 mph), the forces acting on bodies in a collision can easily exceed one tonne (1000 kg). At greater speed these forces are even higher.

Vehicle occupants not wearing seat belts are not “attached” to the vehicle. In a head-on collision, they will move forward at the same speed their vehicle was travelling just before the impact. This example applies not only to head-on collisions, but to all accidents and collisions.

Even at low speeds the forces acting on the body in a collision are so great that it is not possible to brace oneself with one's hands. In a frontal collision, unbelted passengers are thrown forward and will make violent contact with the steering wheel, dash panel, windscreen or whatever else is in the way

»» Fig. 8.

It is also important for rear passengers to wear seat belts properly, as they could otherwise be thrown forward violently through the vehicle interior in an accident. Passengers in the rear seats who do not use seat belts endanger not only themselves but also the front occupants »» Fig. 9.

How to properly adjust your seat belt

Fastening and unfastening the seat belt

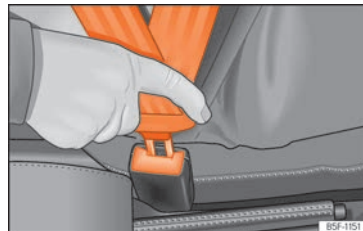


Fig. 10 Insert the latch plate of the seat belt into the buckle.

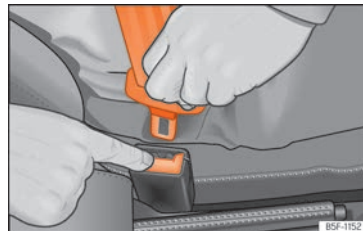


Fig. 11 Release the seat belt's buckle.

Properly worn seat belts hold the vehicle occupants in the position that most protects them in the event of an accident or sudden braking »» » ⚠.

Fastening the seat belt

Fasten your seat belt before each trip.

- Adjust the front seat and headrest correctly »» » page 12.
- Engage the seat backrest of the rear seat in an upright position »» » ⚠.
- Pull the latch plate and place the belt webbing evenly across your chest and lap. Do **not** twist the seat belt when doing so »» » ⚠.
- Engage the latch plate in the buckle of the corresponding seat »» » Fig. 10.
- Pull the belt to ensure that the latch plate is securely engaged in the buckle.

Releasing the seat belt

Only unfasten the seat belt when the vehicle has come to a standstill »» » ⚠.

- Press the red button on the buckle »» » Fig. 11. The latch plate is released from the buckle.
- Guide the belt back by hand so that it rolls up easily and the trim will not be damaged.

⚠ WARNING

- The seat belt cannot offer its full protection unless the seat backrest is in an upright position and the seat belt is worn correctly, according to your size.
- Unbuckling your seat belt while the vehicle is in motion can cause severe or fatal injuries in the event of an accident or sudden braking.
- The seat belt itself, or a loose seat belt, can cause severe injuries if the belt moves from hard areas of the body to soft areas (e.g. the stomach).

Correct seat belt position

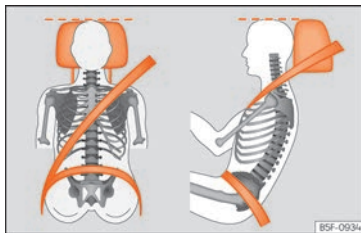


Fig. 12 Correct seat belt and headrest positions, viewed from front and the side.



Fig. 13 Position of seat belt during pregnancy.

Seat belts offer their maximum protection in the event of an accident and reduce the risk of sustaining severe or fatal injuries only when they are properly positioned. Furthermore, if the webbing is correctly positioned, the seat belt will hold the vehicle occupants in the optimum position to ensure the airbag provides the maximum protection. The seat belt must therefore always be worn and the webbing correctly positioned.

Incorrectly worn seat belts can cause severe or even fatal injuries »» » page 12, **Correct sitting position of vehicle occupants.**

- The shoulder part of the seat belt must lie on the centre of the shoulder, never across the neck or the arm, under the arm or behind the shoulder.
- The lap part of the seat belt must lie across the pelvis, never across the stomach. »»

- The seat belt must lie flat and fit comfortably. Pull the belt tight if necessary to take up any slack.

In the case of **pregnant women**, the seat belt must lie evenly across the chest and as low as possible over the pelvis, never across the stomach and must be worn properly at all times during the pregnancy »» Fig. 13.

Adapting the position of the belt webbing to your size

The seat belt can be adapted using the following equipment:

- Belt height adjustment for the front seats.
- Front seat height adjustment.

⚠ WARNING

An incorrectly worn seat belt web can cause severe or fatal injuries in the event of an accident.

- The shoulder part of the seat belt must lie on the centre of the shoulder, never across the neck or the arm.
- The seat belt must lie flat and fit comfortably on the torso
- The lap part of the seat belt must lie across the pelvis, never across the stomach. The seat belt must lie flat and fit comfortably on the pelvis Pull the belt tight if necessary to take up any slack.

- For pregnant women, the lap part of the seat belt must lie as low as possible over the pelvis and always lie flat, "surrounding" the stomach»» Fig. 13.

- Do not twist the seat belt while it is fastened.
- Once the seat belt is positioned correctly, don't pull it away from your body with your hand.
- Do not lie the seat belt across rigid or fragile objects, e.g. glasses, pens or keys.
- Never use seat belt clips, retaining rings or similar instruments to alter the position of the belt webbing.

i Note

If your physical constitution prevents you from maintaining the correct position of the belt webbing, contact a specialised workshop for help with any special devices to ensure the optimum protection of the seat belt and airbag. SEAT recommends taking your car in for technical service.

Fastening or unfastening the seat belt with two buckles

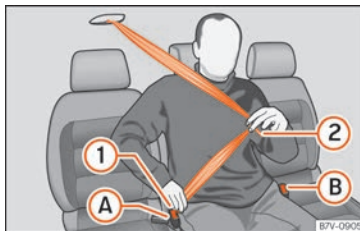


Fig. 14 Fasten the seat belt on the centre seat in the second row of seats

Properly worn seat belts hold the vehicle occupants in the position that most protects them in the event of an accident or sudden braking »» ⚠.

The seat belts for the centre seat in the second row of seats and for the seats in the third row of seats are fastened using two buckles.

Fastening the seat belt

Fasten your seat belt before each trip.

- Adjust the rear seat and headrest correctly »» page 12.
- Engage the seat backrest of the rear seat in an upright position »» ⚠.

- Use latch plate of the belt »» Fig. 14 ① to pull the seat belt down. Do **not** twist the seat belt when doing so »» ⚠.
- Engage the latch plate ① in the buckle of the corresponding seat A.
- Use the latch plate »» Fig. 14 ② to pull the seat belt across your lap.
- Engage the latch plate ② in the buckle of the corresponding seat B.
- Pull the belt to ensure that **both** latch plates are securely engaged in the buckles.

Unfastening the seat belt

The seat belt must not be unfastened until the vehicle has come to a standstill »» ⚠.

- Press the red button on the buckle »» Fig. 14 A. The latch plate will come out of the buckle.
- Press the red button on the buckle »» Fig. 14 B. The latch plate will come out of the buckle.
- Guide the belt back by hand so that it rolls up easily and the trim will not be damaged.

⚠ WARNING

An incorrectly worn seat belt web can cause severe or fatal injuries in the event of an accident.

- **The seat belt cannot offer its full protection unless the seat backrests are in an upright position and the seat belt is worn correctly, according to your size.**
- **Unbuckling your seat belt while the vehicle is in motion can cause severe or fatal injuries in the event of an accident or sudden braking.**

i Note

Seat belts with two buckles include a diagram to show how to fasten the seat belt.

Seat belt height adjustment



Fig. 15 Next to the front seats: belt height adjuster.

Using the height adjusters for the front seats and the outer seats of the second row, the position of the seat belts can be adjusted in the shoulder area according to the height of the occupant:

- Keep the guide device pressed down in the direction of the arrow »» Fig. 15.
- Move the guide device up or down until the seat belt lies over the centre of your shoulder »» page 18.
- Release the guide device.
- Pull the belt sharply to check that the device is engaged securely.

⚠ WARNING

Never adjust the belt height while the vehicle is in motion.

Seat belt tensioners

How the seat belt tensioner works

The seat belts for the front seats and the side rear seats on the second row¹⁾ are equipped with belt tensioners.

The belt tensioners are activated by sensors, although only in severe head-on, lateral and »

¹⁾ Depending on version/market.

rear-end collisions. This retracts and tightens the seat belts, reducing the forward motion of the occupants.

The belt pre-tensioners work in combination with the airbag system. In case of overturn, the pre-tensioners do not activate unless the head airbags are deployed.

Note

- If the seat belt tensioners are triggered, a fine dust is produced. This is normal and it is not an indication of fire in the vehicle.
- The relevant safety requirements must be observed when the vehicle or components of the system are scrapped. Specialised workshops are familiar with these regulations, which are also available to you.

Maintenance and disposal of seat belt tensioners

The belt tensioners are components of the seat belts that are installed in the seats of your vehicle. If you work on the belt tensioners or remove and install parts of the system when performing other repair work, the seat belt may be damaged. The consequence may be that, in the event of an accident, the belt tensioners function incorrectly or may not function at all.

So that the effectiveness of the seat belt tensioner is not reduced and that removed parts do not cause any injuries or environmental pollution, regulations, which are known to the specialised workshops, must be observed.

WARNING

- Improper use or repairs not carried out by qualified mechanics increase the risk of severe or fatal injuries. The belt tensioners may fail to trigger or may trigger in the wrong circumstances.
- The seat belt tensioner, seat belt and automatic retractor cannot be repaired.
- Any work on the belt tensioners and seat belts, including the removal and refitting of system parts in conjunction with other repair work, must be performed by a specialised workshop only.
- The belt tensioners will only provide protection for one accident and must be changed if they have been activated.

For the sake of the environment

Airbag modules and belt tensioners may contain perchlorate. Observe the legal requirements for their disposal.

Airbag system

Brief introduction

Why is it so important to wear a seat belt and to sit correctly?

For the inflating airbags to achieve the best protection, the seat belt must always be worn properly and the correct sitting position must be assumed.

The airbag system is not a substitute for seat belts, but it is an integral part of the vehicle's overall passive safety system. Please bear in mind that the airbag system can only work effectively when the vehicle occupants are wearing their seat belts correctly and have adjusted the headrests properly. Therefore, it is most important to properly wear the seat belts at all times, not only because this is required by law in most countries, but also for your safety »»» page 15, The whys and wherefores of seat belts.

The airbag inflates in a matter of seconds, so if you are not properly seated when the airbag is triggered, you may sustain fatal injuries. Therefore, it is essential that all vehicle occupants assume a correct sitting position while travelling.

Sharp braking before an accident may cause a passenger not wearing a seat belt to be

thrown forward into the area of the deploying airbag. In this case, the inflating airbag may inflict critical or fatal injuries on the occupant. This also applies to children.

Always maintain the greatest possible distance between yourself and the front airbag. This way, the front airbags can completely deploy when triggered, providing their maximum protection.

The most important factors for triggering the airbag are the type of accident, the angle of impact and the vehicle speed.

Whether or not the airbags are triggered depends primarily on the vehicle deceleration rate resulting from the collision and detected by the control unit. If the vehicle deceleration occurring during the collision and measured by the control unit remains below the specified reference values, the front, side and/or head-protection airbags will not be triggered. Take into account that the visible damage in a vehicle involved in an accident, no matter how serious, is not a determining factor for the airbags to have been triggered.

WARNING

- **Wearing the seat belt incorrectly or assuming an incorrect sitting position can lead to critical or fatal injuries.**
- **All vehicle occupants, including children, who are not properly belted can sustain critical or fatal injuries if the airbag is trig-**


gered. Children up to 12 years old should always travel on the rear seat. Never transport children in the vehicle if they are not restrained or the restraint system is not appropriate for their age, size or weight.

- **To reduce the risk of injury from an inflating airbag, always wear the seat belt properly »» page 15.**


Description of the airbag system

The airbag system offers additional protection for the occupants in combination with the seat belts.

The airbag system comprises the following modules (as per vehicle equipment):

- Electronic control unit
- Front airbags for driver and passenger
- Knee airbag for the driver
- Side airbags
- Head airbag
- Airbag control lamp  on the instrument panel »» page 24
- Key-operated switch for front passenger airbag
- Control lamp for disabled/enabled status of the front passenger airbag.

The airbag system operation is monitored electronically. The airbag control lamp will illuminate for a few seconds every time the ignition is switched on (self-diagnosis).

There is a fault in the system if the control lamp :

- does not light up when the ignition is switched on »» page 24,
- turns off after 4 seconds after the ignition is switched on,
- turns off and then lights up again after the ignition is switched on,
- illuminates or flashes while the vehicle is moving.

The airbag system is not triggered if:

- the ignition is switched off
- there is a minor frontal collision
- there is a minor side collision
- there is a rear-end collision
- the vehicle turns over.

WARNING

- **The seat belts and airbags can only provide maximum protection if the occupants are seated correctly »» page 12.**
- **If a fault has occurred in the airbag system, have the system checked immediately by a specialised workshop. Otherwise there is a danger that during a collision, the**

»

system may fail to trigger, or not trigger correctly.

Airbag activation

The airbags deploy extremely rapidly, within thousands of a second, to provide additional protection in the event of an accident. A fine dust may develop when the airbag deploys. This is normal and it is not an indication of fire in the vehicle.

The airbag system is only ready to function when the ignition is on.

In special accidents instances, several airbags may activate at the same time.

In the event of minor head-on and side collisions, rear-end collisions, overturning or roll-over of the vehicle, airbags **do not activate**.

Activation factors

The conditions that lead to the airbag system activating in each situation cannot be generalised. Some factors play an important role, such as the properties of the object the vehicle hits (hard/soft), angle of impact, vehicle speed, etc.

Deceleration trajectory is key for airbag activation.

The control unit analyses the collision trajectory and activates the respective restraint system.

If the deceleration rate is below the predefined reference value in the control unit the airbags will not be triggered, even though the accident may cause extensive damage to the car.

The following airbags are triggered in serious head-on collisions:

- Driver airbag.
- Front passenger front airbag
- Knee airbag for the driver.

The following airbags are triggered in serious side-on collisions:

- Front side airbag on the side of the accident.
- Curtain (head) airbag on the side of the accident.

In an accident with airbag activation:

- the interior lights switch on (if the interior light switch is in the courtesy light position);
- the hazard warning lights switch on;
- all doors are unlocked;
- the fuel supply to the engine is cut.

Operation of the airbags

Airbag system control lamps



It lights up on the combi-instrument

Fault in the airbag system and seat belt tensioners . Have the system checked immediately by a specialised workshop.










OFF It lights up on the dash panel

Fault in the airbag system. Have the system checked immediately by a specialised workshop.

Front passenger front airbag deactivated. Check if the airbag should be kept deactivated

Several warning and control lamps light up for a few seconds when the ignition is switched on, signalling that the function is being verified. They will switch off after a few seconds.

If the front passenger airbag is deactivated, the warning lamp **PASSENGER AIR BAG OFF**  remains lit on the dash panel to remind you that the airbag is deactivated. If, with the front passenger airbag deactivated, this lamp **does not remain lit** or if it is lit along with the control lamp  on the instrument panel, there is a fault in the airbag system   . If the control lamp is flashing, there is a fault in the disabling of the airbag system  . Have

the system checked immediately by a specialised workshop.

⚠ WARNING

In the event of a fault in the airbag and seat belt tensioner system, the airbags and seat belts may not trigger correctly, may fail to trigger or may even trigger unexpectedly.

- The vehicle occupants run the risk of sustaining severe or fatal injuries. Have the system checked immediately by a specialised workshop.
- Do not mount a child seat in the front passenger seat or remove the mounted child seat! The front passenger front airbag may deploy during an accident in spite of the fault.

ⓘ CAUTION

Always pay attention to any lit control lamps and to the corresponding descriptions and instructions to avoid damage to the vehicle or harm to the occupants.

Front airbags

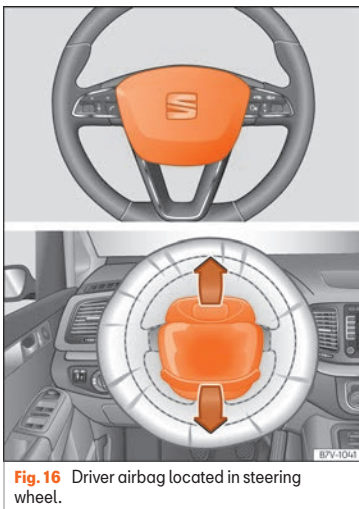


Fig. 16 Driver airbag located in steering wheel.

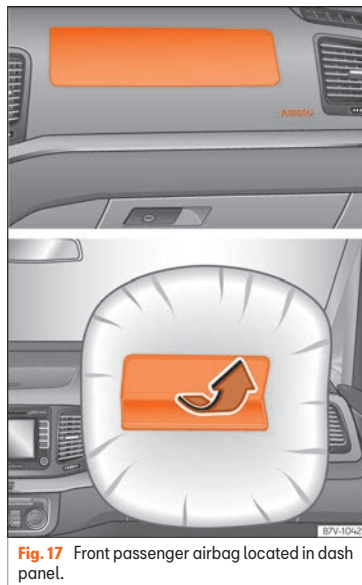


Fig. 17 Front passenger airbag located in dash panel.

The driver's front airbag is housed in the steering wheel and that of the front passenger, on the instrument panel. Airbags are identified by the word "AIRBAG".

The airbag covers fold open and remain attached to the steering wheel » **Fig. 16** and the dash panel » **Fig. 17** when the driver and »

front passenger airbags, respectively, are triggered.

In conjunction with the seat belts, the front airbag system gives the front occupants additional protection for the head and chest in the event of a severe frontal collision »» ⚠.

Their special design allows the controlled escape of the propellant gas when an occupant puts pressure on the bag. Thus, the head and chest are protected by the airbag. After the collision, the airbag deflates sufficiently to allow visibility.

⚠ WARNING

- The deployment space between the front passengers and the airbags must not in any case be occupied by other passenger, pets and objects.
- The airbags provide protection for just one accident; replace them once they have deployed.
- It is also important not to attach any objects such as cup holders or telephone mountings to the surfaces covering the airbag units.

Activate and deactivate front passenger front airbag



Fig. 18 In the glove compartment, on the front passenger side: key switch for activating and deactivating the front passenger airbag.

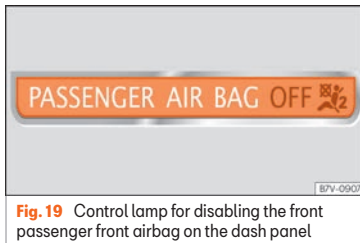


Fig. 19 Control lamp for disabling the front passenger front airbag on the dash panel

Deactivate the front passenger front airbag only if you have to use a rear-facing child seat in the front passenger seat.

SEAT recommends fitting the child seat in the rear seat to avoid having to deactivate the front passenger airbag.

When the front passenger airbag is **deactivated**, this means that only the front passenger front airbag is deactivated. All the other airbags in the vehicle remain activated.

Deactivate and activate the front passenger front airbag

- Switch the ignition off.
- Open the glove compartment on the front passenger side.
- Insert the key into the slot of the switch for deactivating the front passenger airbag »» Fig. 18. About 3/4 of the key should enter; this is as far as it will go.
- Turn the key gently to change its position to **OFF** (deactivate) or to **ON** (activate). If you have difficulty, ensure that you have inserted the key as far as it will go.
- Close the glove compartment.
- When deactivating the airbag, switch the ignition on and check that the control lamp **OFF** ⚡, with the lettering **PASSENGER AIR BAG** remains lit in the middle of the dash panel »» Fig. 19.
- When reactivating the airbag, check that when the ignition is switched on, the **OFF** ⚡ control lamp does not turn on.

⚠ WARNING

- The driver of the vehicle is responsible for disabling or switching on the airbag.
- Always switch off the ignition before disabling the front passenger airbag! Failure to do so could result in a fault in the airbag deactivation system.
- Never leave the key in the airbag disabling switch as it could get damaged or enable or disable the airbag during driving.
- If for any reason an airbag is deactivated, reactivate it as soon as possible so that it can fulfil its protective function.

Knee airbag

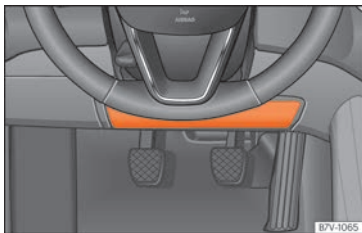


Fig. 20 On the driver side: location of the knee airbag

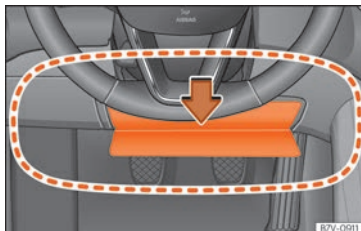


Fig. 21 On the driver side: airbag action radius for the knees.

The knee airbag is located on the driver side below the dash panel » Fig. 20. Airbags are identified by the word "AIRBAG".

The area framed in red (deployment area) » Fig. 21 is covered by the knee airbag when it is deployed. Objects should never be placed or mounted in this area.

⚠ WARNING

- The knee airbag is deployed in front of the driver's knees. Always keep the deployment areas of the knee airbags free.
- Never not fix objects to the cover or in the deployment area of the knee airbag.
- Adjust the driver's seat so that there is a distance of at least 10 cm (4 inches) between your knees and the location of this airbag. If your physical constitution prevents you from meeting these require-

ments, make sure you contact a specialised workshop.

Side airbags

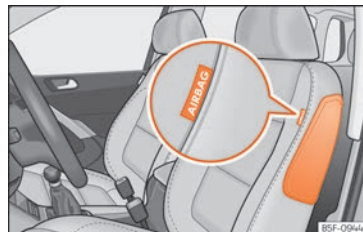


Fig. 22 Side airbag in driver's seat.



Fig. 23 Range of action of the front and rear side airbags. With 5 and 7 seats. »

The side airbags are located in the driver's seat and front passenger seat backrests
»» Fig. 22.

Depending on the equipment of the model, the outer seats of the second row of seats may also be fitted with side airbags, located between the seat backrests and the access area.

The locations are identified by the text "AIR-BAG" in the upper region of the backrests.

In conjunction with the seat belts, the side airbag system provides additional protection for the upper body in the event of a severe side collision **»» ⚠.**

In a side collision, the side airbags reduce the risk of injury to passengers to the areas of the body facing the impact. In addition to their normal protection, the seat belts also hold the passengers in the event of a side collision; this is how these airbags provide maximum protection.

⚠ WARNING

- If you do not wear a seat belt, if you lean forward, or are not seated correctly while the vehicle is in motion, you are at a greater risk of injury if the side airbag system is triggered in an accident.
- In order for the side airbags to provide their maximum protection, the prescribed sitting position must always be maintained with seat belts fastened while travelling.

- In a side-on collision the side airbags will not work if the sensors do not correctly measure the pressure increase on the interior of the doors, due to air escaping through the areas with holes or openings in the door panel.
- Never drive if the interior door panels have been removed or if the panels have not been correctly fitted.
- Never drive the vehicle if the loudspeakers in the door panels have been removed, unless the holes left by the loudspeakers have been closed properly.
- Always check that the openings are closed or covered if loudspeakers or other equipment are fitted inside the door panels.
- Occupants of the outer seats must never carry any objects or pets in the deployment space between them and the airbags, or allow children or other passengers to travel in this position. It is also important not to attach any accessories (such as cup holders) to the doors. This would impair the protection offered by the side airbags.
- The built-in coat hooks should be used only for lightweight clothing. Do not leave any heavy or sharp-edged objects in the pockets.
- Great forces, such as hard blows or kicks, must not be exerted upon the backrest bolster because the system may be damaged. In this case, the side airbags would not be triggered.

- Under no circumstances should protective covers be fitted over seats with side airbags unless the covers have been approved for use in your vehicle. Because the airbag deploys from the side of the backrest, the use of conventional seat covers would obstruct the side airbag, seriously reducing the airbag's effectiveness.
- Any damage to the original seat upholstery or around the seams of the side airbag units must be repaired immediately by a specialised workshop.
- The airbags provide protection for just one accident; replace them once they have deployed.
- Any work on the side airbag system or removal and installation of the airbag components for other repairs (such as removal of the front seat) should only be performed by a specialised workshop. Otherwise, faults may occur during the airbag system operation.

head-protection airbags

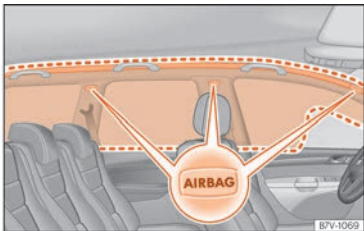


Fig. 24 On the left side of the vehicle: location and field of action of the head-protection airbag.



Fig. 25 Deployed head-protection airbags.

The head-protection airbags are located on both sides in the interior above the doors » **Fig. 24** and are identified with the text "AIRBAG".

In conjunction with the seat belts, the head-protection airbag system gives the vehicle occupants additional protection for the head and upper body in the event of a severe side collision » **△**.

The area framed in red is covered by the head-protection airbag when it is deployed » **Fig. 24** (deployment area). Therefore, objects should never be placed or mounted in this area » **△**.

In the event of a side collision the head-protection airbag is triggered on the impact side of the vehicle.

The head-protection airbags reduce the risk of injury to passengers in the front and rear side seats facing the impact.

△ WARNING

- In order for the head-protection airbags to provide their maximum protection, the prescribed sitting position must always be maintained with seat belts fastened while travelling.
- For safety reasons, the head-protection airbag must be disabled in those vehicles fitted with a screen dividing the interior of the vehicle. See your technical service to make this adjustment.
- There must be no other persons, animals or objects between the occupants of the outer seats and the deployment space of the head-protection airbags so that the

head-protection airbag can deploy completely without restriction and provide the greatest possible protection. Therefore, sun blinds which have not been expressly approved for use in your vehicle may not be attached to the side windows.

- The built-in coat hooks should be used only for lightweight clothing. Do not leave any heavy or sharp-edged objects in the pockets. Please, do not hang the clothes on coat hangers.

- The airbags provide protection for just one accident; replace them once they have deployed.

- Any work on the head-protection airbag system or removal and installation of the airbag components for other repairs (such as removal of the roof lining) should only be performed by a specialised workshop. Otherwise, faults may occur during the airbag system operation.

- The side and head airbags are managed through sensors located in the interior of the front doors. To ensure the correct operation of the side and head-protection airbags neither the doors nor the door panels should be modified in any way (e.g. fitting loudspeakers). If the front door is damaged, the airbag system may not work correctly. All work carried out on the front door must be done in a specialised workshop.

Transporting children safely

Child safety

Introduction

For safety reasons, as we have learned from accident statistics, we recommend that children under 12 years of age travel in the rear seats. Depending on their age, height and weight, children travelling in rear seats must use a child seat or a seat belt. For safety reasons, the child seat should be installed in the rear seat, behind the front passenger seat or in the centre back seat.

The physical laws involved and the forces acting in a collision apply also to children » page 17. But unlike adults, children do not have fully developed muscle and bone structures. This means that children are subject to a greater risk of injury.

To reduce the risk of injuries, children must always use special child restraint systems when travelling in the vehicle.

We recommend the use of child safety products from the SEAT Original Accessories Programme, which includes systems for all ages made by "Peke" [not for all countries] [see www.seat.com].

These systems have been especially designed and approved, complying with the ECE-R44. regulation.

Follow the manufacturer's instructions and observe any statutory requirements when installing and using child seats. Always read and note » page 31.

We recommend you always carry the manufacturer's Child Seat Instruction Manual together with the on-board documentation.

Child seats by weight group

Child seats by weight group

The child seats are grouped into 5 categories:

Age group	Weight of the child
Group 0	Up to 10 kg
Group 0+	Up to 13 kg
Group 1	From 9 to 18 kg
Group 2	From 15 to 25 kg
Group 3	From 22 to 36 kg



Fig. 26 Examples of child seats.

Child seats that have been tested and approved under the ECE R44 or ECE-R129 standards bear the ECE-R44 or ECE-R129 test marks on the seat (the letter E in a circle with the test number below it).

Follow the manufacturer's instructions and observe any statutory requirements when installing and using child seats.

We recommend you to always include the manufacturer's Child Seat Instruction Manual together with the on-board documentation.

SEAT recommends you use child seats from the **Original Accessories Catalogue**. These child seats have been designed and tested for use in SEAT vehicles. You can find the right child seat for your model and age group at SEAT dealers.

Use only child seats that are officially approved and suitable for the child.

These seats are subject to the ECE-R44 or ECE-R129 standards. ECE-R stands for: Economic Commission for Europe Regulation.

Child seats by approval category

Child seats may have the approval category of universal, semi-universal, vehicle specific (all according to the ECE-R44 standard) or i-Size (according to the ECE-R129 standard).

- **Universal:** child seats with universal approval can be installed in all vehicles. There is no need to consult any list of models. In the case of universal approval for ISOFIX, the child seat is additionally provided with a Top Tether belt.
- **Semi-universal:** semi-universal approval, in addition to the standard requirements of universal approval, requires safety devices to lock the child seat, which require additional testing. Child seats with semi-universal approval include a list of vehicle models for which they can be installed.
- **Vehicle-specific:** vehicle-specific approval requires a dynamic test of the child seat for each vehicle model separately. Child seats with vehicle-specific approval also include a list of vehicle models for which they can be installed.
- **i-Size:** child seats with i-Size approval must meet the requirements set out in the ECE-R129 standard in relation to installation and safety. Child seat manufacturers can tell you which seats have i-Size approval for this vehicle.

Fitting and using child seats



Fig. 27 Airbag sticker: on the passenger's sun visor



Fig. 28 Airbag sticker: on the rear frame of the passenger side door

Warnings about fitting a child seat

Take the following general warnings into account if you are going to fit a child seat. They are valid for all child seats regardless of their attachment system.

- Please read and follow the child seat manufacturer's operating instructions.
- The child seat should preferably be fitted to the rear seat behind the front passenger seat so that the child can exit the vehicle on the pavement side.
- Set the height of the seat belt such that it adapts to the child seat naturally, without twisting. The lowest position of the seat belt height regulator must be used with rear-facing child seats.
- To correctly use a child seat in the back, the front backrest must be adjusted so that there is no contact with the child seat in the back in the case that it goes opposite to the direction of the car. In the case of front facing restraint systems, the front backrest must be adjusted so that there is no contact with the child's feet.
- If a semi-universal type chair is to be installed, in which the method of attachment to the car is through the seat belt and support bracket, it should never be installed in the central rear seat as the ground clearance is lower than in other places and the support bracket will not allow the seat to remain sufficiently stable.
- When fitting a child seat on the front passenger seat, the seat must be moved backwards as far as possible and placed in the »

highest position. The backrest must also be put in a vertical position¹⁾.

Important information about the front passenger front airbag

A sticker with important information about the passenger airbag is located on the passenger's sun visor and/or on the passenger side door frame »» Fig. 27.

Read and always observe the safety information included in the following chapters:

- Safety distance with respect to the passenger airbag »» page 22.
- Objects between the passenger and the passenger side airbag »» ⚠ in Front airbags on page 26.

The passenger side front airbag, when enabled, is a serious risk for a child that is facing backward since the airbag can strike the seat with such force that it can cause serious or fatal injuries. Children up to 12 years old should always travel on the rear seat.

Therefore we strongly recommend you to transport children on the rear seats. This is the safest location in the vehicle. Alternatively, the front passenger airbag can be dis-

abled with a key-operated switch »» page 26. When transporting children, use a child seat suitable for the age and size of each child »» page 30.

⚠ WARNING

- If a child seat is secured to the front passenger seat, the risk to the child of sustaining critical or fatal injuries in the event of an accident increases.
- An inflating front passenger airbag can strike the rear-facing child seat and project it with great force against the door, the roof or the backrest.
- Never install a child seat facing backwards on the front passenger seat unless the front passenger front airbag has been disabled. Risk of potentially fatal injuries to the child! However, if necessary, the front passenger front airbag must be deactivated »» page 26. If the passenger seat has a height adjustment option, move it to the highest, most upright position. If you have a fixed seat, do not install any child restraint system in this location.
- For those vehicles that do not include a key lock switch to deactivate the airbag, the vehicle must be taken to a technical service. Do not forget to reconnect the air-

bag when an adult wants to sit in the front passenger seat.

- Never allow a child to be transported in a vehicle without being properly secured, or to stand up or kneel on a seat while travelling. In an accident, the child could be flung through the vehicle, causing possibly fatal injuries to themselves and to the other vehicle occupants.
- Never leave a child alone in the child seat or in the vehicle.
- Children who are less than 1.5 metres tall must not wear a normal seat belt without a child seat, as this could cause injuries to the abdominal and neck areas during a sudden braking manoeuvre or in an accident.
- When a child seat is mounted in the rear seats, the door child-proof lock should be activated »» page 107.

Attachment systems

Depending on the country, different attachment systems are used for safely installing child seats.

¹⁾ Compliance with current national legislation and the manufacturer's instructions is required when using or installing child seats.

Attachment systems overview

- **ISOFIX:** ISOFIX is a standardised attachment system allowing quick and safe attachment of child seats in the vehicle. ISOFIX attachment establishes a rigid connection between the child seat and the car body.

The child seat has two rigid attachment clips, called connectors. These connectors are fitted into the ISOFIX attachment rings found between the seat cushion and the backrest of the vehicle's back seat (on the sides). ISOFIX attachment systems are used mainly in Europe »» page 33. If necessary, ISOFIX attachment may have to be supplemented with a Top Tether belt or a support bracket.

- **Automatic three-point seat belt.** Whenever possible, it is preferable to attach the child seats with the ISOFIX system rather than attaching them with an automatic three-point seat belt »» page 35.

Additional attachment:

- **Top Tether:** the Top Tether belt is guided over the back of the rear seat and attached to an anchor point with a hook. Anchor points are located at the back of the rear seat backrest on the boot side »» page 35. The rings for retaining the Top Tether belt are marked with an anchor symbol.
- **Support bracket:** some child seats rest on the floor of the vehicle with a support bracket. The support bracket prevents the child seat

from tipping forward in the event of impact. Child seats fitted with a support bracket should only be used in the passenger seat and side rear seats »» ⚠. For the assembly of this type of seat you should also consult the list of approved vehicles for this assembly, available in the instructions for child restraint systems.

Recommended systems for attaching child seats

SEAT recommends attaching child seats as follows:

- **Baby carriers or child seats in the opposite direction of travel:** ISOFIX and support bracket or i-Size.
- **Child seats in the direction of travel:** ISOFIX and Top Tether.

⚠ WARNING

Incorrect use of the support bracket can cause serious or fatal injury.

- **Make sure the support bracket is correctly and safely installed.**

Fixing a child seat with the ISOFIX and Top Tether system

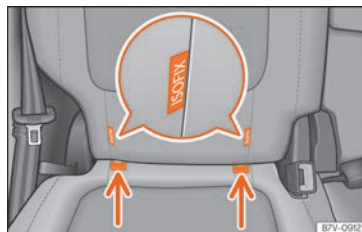


Fig. 29 Rear seats: ISOFIX securing rings.



Fig. 30 Rear seats: fitting a child seat with the ISOFIX system.

Child seats can be secured quickly, easily and safely on the rear seats with the “ISOFIX” and Top Tether system.

Two “ISOFIX” retaining rings are fitted on each rear seat. In some vehicles, the rings are »»

secured to the seat frame and, in others, they are secured to the rear floor. The "ISOFIX" rings are located between the rear seat backrest and the seat cushioning »» Fig. 29. The Top Tether rings are located on the rear part of the rear seat backrests (behind the backrest or in the luggage compartment) »» page 35.

To understand the compatibility of the "ISOFIX" systems in the vehicle, check the table below.

Age group	Class according to size ^{a)}	Front passenger seat	Rear seats
Group 0: up to 10 kg	E	X	IUF
	E	X	IUF
Group 0+: up to 13 kg	D	X	IUF
	C	X	IUF
Group 1: 9 to 18 kg	D	X	IUF
	C	X	IUF
	B	X	IUF
	B1	X	IUF
	A	X	IUF

IUF: suitable place for installing an ISOFIX child seat with universal approval.

^{a)} The indication of class according to size corresponds to the authorised bodyweight for the child seat. In child seats with universal or semi-universal approval, the class according to size is indicated on the ECE approval label. The indication of class according to size is stated on the corresponding child seat.

Securing the child seat with the "ISOFIX" system

You are obliged to follow the seat manufacturer's instructions.

- Press the child seat onto the "ISOFIX" retaining rings until the child seat can be heard to engage securely »» Fig. 30. If the child seat is equipped with Top Tether anchor points, secure it to the correspondent ring »» page 35. Observe the manufacturer's instructions.
- Pull on both sides of the child seat to ensure that it is properly anchored.

Child seats with the "ISOFIX" and Top Tether attachment system are available from Technical Services.

WARNING

The securing rings are designed only for use with "ISOFIX" and Top Tether system child seats.

- Never secure other child seats that do not have the "ISOFIX" or Top Tether system, or safety belts or any other objects to the securing rings – as this can result in potentially fatal injuries to the child.
- Ensure that the child seat is correctly secured to the "ISOFIX" and Top Tether securing rings.

Top Tether securing belts

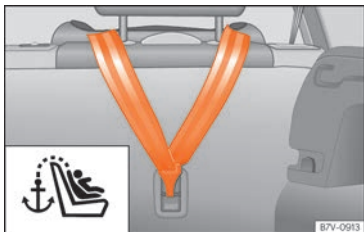


Fig. 31 Back of the rear seats: Top Tether securing rings.

Child seats with the Top Tether system come with a strap for securing the seat to the vehicle anchor point, located at the back of the rear seat backrest and provide greater restraint.

The objective of this strap is to reduce forward movements of the child seat in a crash,

Fitting a child seat using the seat belt

If you want to fit a universal approval category (U) child seat in your vehicle, you must check that the seat is approved for your vehi-

cle. You will find any necessary information on the child seat's orange ECE approval la-

Using the Top Tether in rear-facing mounted seats

Currently, there are very few rear-facing child safety seats that have Top Tether. Please carefully read and follow the seat manufacturer instructions to learn the proper way to install the Top Tether strap.

Securing the retainer strap

- Follow the manufacturer's instructions to deploy the child seat Top Tether retaining strap.
- Place the belt under the headrest of the back seat (depending on the instructions of the chair itself, lift or remove the headrest if necessary).
- Slide the strap and secure it properly with the anchorage of the backrest »» **Fig. 31.**

- Firmly tighten the strap following the manufacturer's instructions.

Releasing the retaining strap

- Loosen the strap following the manufacturer's instructions.
- Push the lock and release it from the anchoring support.

⚠ WARNING

An undue installation of the safety seat will increase the risk of injury in the event of a crash.

- **Never tie the retainer strap to a hook in the luggage compartment.**
- **Never secure or tie luggage or other items to the lower anchorages (ISOFIX) or the upper ones (Top Tether).**

bel. The following table shows the different fitting options. »

Safety

Age group	Weight of the child	Front passenger seat		Second row of seats:		Third row of seats
		Airbag enabled	Airbag deactivated	Interior	Exterior	
Group 0	Up to 10 kg	X	U	U		U
Group 0+	Up to 13 kg	X	U	U		U
Group 1	Rear-facing	From 9 to 18 kg	X	U	U	U
	Forward-facing	From 9 to 18 kg	U	X	U	U
Group 2	From 15 to 25 kg	U	X	U	U/B	U
Group 3	From 22 to 36 kg	U	X	U	U/B	U

U: universal.

X: vehicle seat unsuitable for fitting this group of child seat.

B: integrated child seat.

Fitting a child seat using the seat belt

- Set the height of the seat belt such that it adapts to the child seat naturally, without twisting. The lowest position of the seat belt height regulator must be used with rear-facing child seats.
- Put the seat belt in place and pass it through the child seat according to the instructions of the child seat manufacturer.
- Make sure that the seat belt is not twisted.
- Insert the latch plate into the seat's buckle until you hear the engagement click.

WARNING

When travelling, children must be secured in the vehicle with a restraint system suitable for age, weight and size.

- Read and always observe information and warnings concerning the use of child seats»» page 31.

Integrated child seat

Introduction

The integrated child seat is only suitable for children in Group 2 (15-25 kg) and Group 3

(22-36 kg), according to the ECE-R44 regulation.

WARNING

Child travelling without their seat belt fastened or not secured using a suitable restraint system may sustain fatal injuries if the airbag is deployed.

- Children up to 12 years old should always travel on the rear seat.
- Always disable the front passenger front airbag if, in exceptional cases, you have no alternative but to transport a child in a rear-facing child safety seat on the front passenger seat.

- Children must always be protected with a child restraint system suited to their height and weight.
- Always fasten children's seat belts correctly.

⚠ WARNING

Children must travel in a child seat appropriate to their weight and height while the vehicle is in motion.

- Children must always be protected with a child restraint system suited to their height and weight.
- Children must assume the proper sitting position and be properly belted in while travelling.
- The shoulder part of the seat belt must lie approximately on the centre of the shoulder, never across the neck or the arm.
- The seat belt must lie close to the upper part of the body.
- The lap belt part must lie across the pelvis, not across the stomach, and always fit closely.
- Allow the belt to retract until it fits tightly over the child's seat.
- Never hold children or babies on your lap.
- Always use a child seat and the seat belt for children who are under 1.5 m tall. The normal seat belt could cause injuries to the abdominal and neck areas.
- Only one child may occupy a child seat.

- Read and follow the information and warnings provided by the child seat manufacturer.
- Never leave an unsupervised child alone on a child seat or in the vehicle.
- All modifications to the integrated child seat must be carried out by a specialised workshop.
- Replace the child seat or any seat components damaged or involved in an accident.

⚠ WARNING

Loose objects could fly uncontrollably around the vehicle interior and cause injuries in the event of an accident or sudden braking.

- Do not leave toys or other hard, loose objects on the child seat or on the seat while the vehicle is in motion.

Unfold the integrated child seat

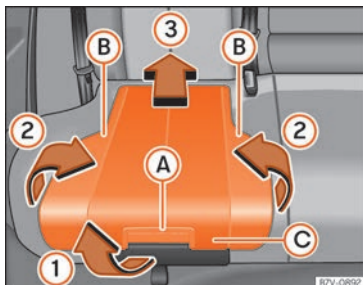


Fig. 32 Integrated child seat: lift the cushion.

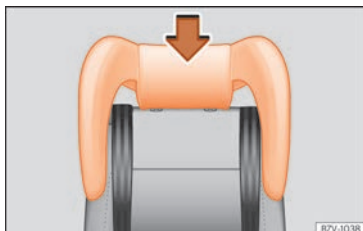


Fig. 33 Integrated child seat: fit its headrest.

Lifting the cushion

- Pull the unlock lever »» **Fig. 32** (A) on the cushion in the direction of the arrow »» **Fig. 32** (1).



- Fold both sides »» Fig. 32 B up in the direction of the arrow »» Fig. 32 2.
- Push the cushion »» Fig. 32 C back in the direction of the arrow »» Fig. 32 3 until it engages.

Install the headrest on the child safety seat

- Remove the head support and store it safely in the vehicle »» page 133.
- Make sure that the seat belt guide is installed in the head support of the seat for children on the window side »» page 38.
- Enter the child seat head support in the corresponding backrest until it fits correctly into place »» Fig. 33.
- Make sure that the rear seats and backrests are correctly locked into place, pulling on both of them.

Seat belt route with integrated child seat

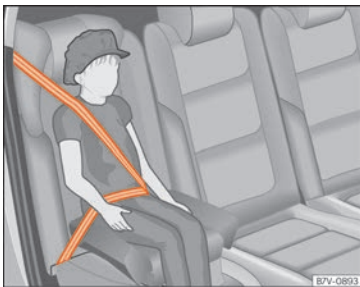


Fig. 34 Integrated child seat: fitting the seat belt.



Fig. 35 Integrated child seat: seat belt route with guide handle.

Using the guide handle »» Fig. 35, position the seat belt so that the shoulder part of the belt lies on the centre of the child's shoulder.

Seat belt guide handle

- Secure the seat belt guide handle to the side headrest on the window side. The guide handle is secured by a button.
- Open the upper button on the seat belt guide handle and pass the belt webbing below the side headrest and through the guide handle.
- Close the button again.

Adjusting the seat belt

- Guide the automatic three-point seat belt below the side headrest.
- Pull the latch plate and slowly place the belt webbing across the child's chest and lap.
- Insert the latch plate into the buckle for the appropriate seat and push it down until it is securely locked with an audible click.
- Pull the belt to ensure that the latch plate is securely engaged in the buckle.

⚠ WARNING

The seat belt only offers maximum protection from severe or fatal injuries when it is correctly positioned.

- Children must assume the proper sitting position and be properly belted in while travelling.
- The shoulder belt must be positioned against the middle of the shoulder.
- The seat belt must lie flat and fit comfortably.
- Allow the belt to retract until it fits tightly over the child's seat.
- The lap part of the seat belt must lie across the pelvis, never across the stomach.
- Only one child may occupy a child seat.

Removing the child seat

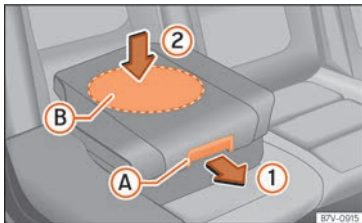


Fig. 36 Integrated child seat: lowering the cushion.

Lowering the cushion

- Pull the unlock lever »» Fig. 36 (A) on the cushion in the direction of the arrow ①.

- Push the cushion down through the central area (B) in the direction of the arrow ② until it safely engages »» ④. The side supports fold away automatically.

Remove the headrest on the child safety seat

- Open the guide lever on the seat belt and guide it by hand to pull the belt back in more easily and without damaging the trim.
- Lift the child seat headrest to the top.
- Fold the backrest of the rear seat forwards »» page 135.
- Remove the headrest on the child safety seat.
- Fitting the headrest.

⚠ CAUTION

When lowering the integrated child seat, only press on the centre of the cushion »» Fig. 36 ②. Otherwise the cushion could bend and not engage properly.

Emergencies

Self-help

Emergency equipment

First aid kit, warning triangle, reflective vests and fire extinguishers

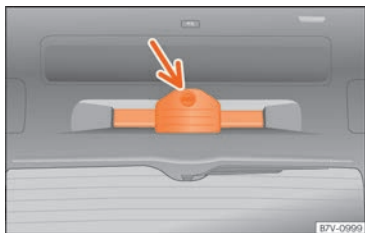


Fig. 37 On the rear lid: warning triangle bracket.

Warning triangle

With the rear lid open, rotate the lock 90°
»» **Fig. 37**. Lower the bracket and remove the warning triangle.

First aid kit

There is a **first aid kit** »» page 152 in the rear left-hand side storage compartment of the luggage compartment.

The first aid kit must comply with legal requirements. Check the expiry date of the contents of the first aid kit.

Reflective vests

Some vehicles have a driver door compartment to store a reflective vest .

Fire extinguisher

There is a fire extinguisher underneath the front passenger seat.

The fire extinguisher must conform to legal requirements, be ready for use and be checked regularly. Check the certification seal on the extinguisher.

⚠ WARNING

Loose objects in the vehicle interior can be violently thrown in case of a sudden manoeuvre or braking and especially in accidents causing serious injury.

- Secure or store fire extinguishers, first aid kit, reflective vests and warning triangle securely in the vehicle.

i Note

- The first aid kit, warning triangle, reflective vests and fire extinguishers are not part of the vehicle's standard equipment.
- The warning triangle should meet legal requirements.

- Before acquiring accessories and emergency equipment see the instructions in "Accessories and spares" »» page 345.

Vehicle tool kit

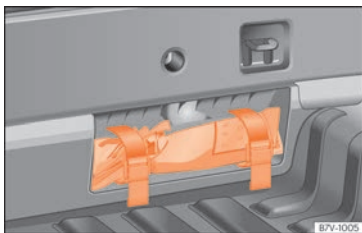


Fig. 38 In the luggage compartment, seen from inside the vehicle: vehicle tool kit in a cavity located in the lock carrier area.

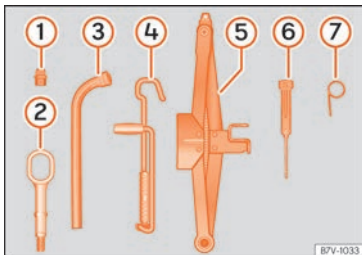


Fig. 39 Underneath the floor panel of the luggage compartment: vehicle tool kit.

Depending on the model, the vehicle tools may be kept in the luggage compartment, in a cavity close to the lock carrier »» Fig. 38. Loosen the safety straps and remove the ve-

hicle tool kit. For vehicles factory-fitted with winter tyres, you will find additional tools in a toolbox located in the luggage compartment.

The tool kit includes:

- ① Adapter for the anti-theft bolt
- ② Towing eye, removable
- ③ Wheel spanner
- ④ Crank handle for jack
- ⑤ Jack
- ⑥ Screwdriver with hexagon socket in the handle for screwing and unscrewing the wheel nuts
- ⑦ Hook for pulling off wheel trims or wheel bolt caps

Some of the items listed are only provided in certain model versions, or are optional extras.

⚠ WARNING

When the vehicle tool kit, tyre mobility set and spare wheel are loose in the interior they can be violently thrown in case of a sudden manoeuvre or braking and especially in accidents, causing serious injury.

- Ensure that the vehicle tool kit, the tyre mobility set and the spare wheel or temporary spare wheel are safely secured in the luggage compartment.

⚠ WARNING

Unsuitable or damaged vehicle tools can cause injury or accidents.

- Never work with inappropriate or damaged tools.

i Note

The jack does not generally require any maintenance. If required, it should be greased using universal type grease.

Folding chocks

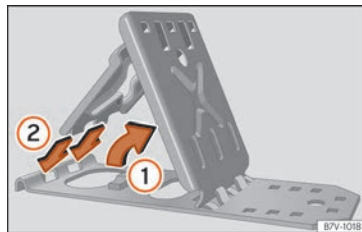


Fig. 40 To unfold the foldable wedges.

The folding chocks are in the tool kit »» page 41.

Assemble the folding chocks

- Lift the base plate »» Fig. 40 ①.

»

- Insert the two “tabs” of the mounting plate into the long openings on the base plate ②.

Correct use

The folding chocks may be used to block the wheel diagonally opposite to the wheel being changed.

The chocks should be placed directly in front and behind the wheel and only be used on firm ground.

WARNING

If the folding chocks are assembled or used incorrectly, an accident may occur and serious injury caused.

- Never use damaged chocks.
- Never use chocks to immobilize the vehicle on a slope.

Tyre repairs

TMS (Tyre Mobility System)

The Tyre Mobility System will reliably seal punctures caused by the penetration of a foreign body of up to about **4 mm** in diameter. **Do not remove foreign objects, e.g. screws or nails, from the tyre.**

After inserting the sealant residue in the tyre, you must again check the tyre pressure about 10 minutes after starting the engine.

You should only use the tyre mobility set if the vehicle is parked in a safe place, you are familiar with the procedure and you have the necessary tyre mobility set! Otherwise, you should seek professional assistance.

Do not use the tyre sealant in the following cases:

- If the wheel rim has been damaged.
- In outside temperatures below -20°C [-4°F].
- In the event of cuts or perforations in the tyre greater than 4 mm.
- If you have been driving with very low pressure or a completely flat tyre.
- If the sealant bottle has passed its use by date.

WARNING

Using the tyre mobility system can be dangerous, especially when filling the tyre at the roadside. Please observe the following rules to minimise the risk of injury:

- Stop the vehicle safely as soon as possible. Park it at a safe distance from surrounding traffic to fill the tyre.
- Ensure the ground on which you park is flat and solid.

- All passengers and particularly children must keep a safe distance from the work area.
- Turn on the hazard warning lights to warn other road users.
- Use the tyre mobility system only if you are familiar with the necessary procedures. Otherwise, you should seek professional assistance.
- The tyre mobility set is intended for temporary emergency use only until you can reach the nearest specialised workshop.
- Replace the repaired tyre with the tyre mobility set as soon as possible.
- The sealant is a health hazard and must be cleaned immediately if it comes into contact with the skin.
- Always keep the tyre mobility set out of the reach of small children.
- Always stop the engine, apply the electronic parking brake and put it in gear when using a manual gearbox, in order to reduce the risk of involuntary movement of the vehicle.

WARNING

A tyre filled with sealant does not have the same performance properties as a conventional tyre.

- Never drive faster than 80 km/h (50 mph).

- Avoid heavy acceleration, hard braking and fast cornering.
- Drive for only 10 minutes at a maximum speed of 80 km/h (50 mph) and then check the tyre.

For the sake of the environment

Dispose of used or expired sealant observing any legal requirements.

Note

A new bottle of sealant can be purchased at SEAT dealerships.

Note

Take into account the separate instruction manual of the tyre mobility system's manufacturer.

Anti-puncture kit contents

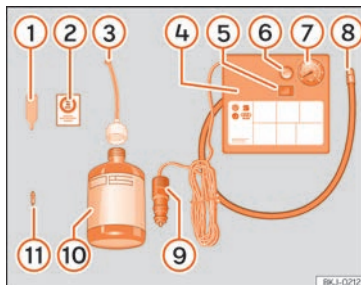


Fig. 41 Standard representation: anti-puncture kit contents.

The anti-puncture kit is located underneath the floor covering in the luggage compartment. It includes the following components

» **Fig. 41:**

- 1 Valve insert remover
- 2 A sticker to be adhered to the instrument cluster, within the driver's visual field, to remind that the maximum advisable speed "max. 80 km/h" or "max. 50 mph"
- 3 Filler tube with cap
- 4 Air compressor
- 5 ON/OFF switch
- 6 Air bleed screw (it can also be integrated in the inflator tube).

7 Warning provided by tyre pressure monitoring system (it can also be integrated in the inflator tube).

8 Tube for inflating tyres

9 12 volt connector

10 Bottle of sealant

11 Spare tyre valve

The **valve insert remover** 1 has a gap at the lower end for a valve insert. The valve insert can only be screwed or unscrewed in this way. This also applies to its replacement part 11.

Sealing and inflating a tyre

Sealing the tyre

- Unscrew the tyre valve cap and insert. Use the » **Fig. 41** 1 tool to remove the insert. Place it on a clean surface.

- Shake the tyre sealant bottle vigorously » **Fig. 41** 10.

- Screw the inflator tube » **Fig. 41** 8 into the sealant bottle. The bottle's seal will break automatically.

- Remove the lid from the filling tube » **Fig. 41** 3 and screw the open end of the tube into the tyre valve.

- With the bottle upside down, empty **all** of the contents into the tyre.

»

- Remove the bottle from the valve.
- Place the insert back into the tyre valve using the tool »» Fig. 41 ①.

Inflating the tyre

- Screw the compressor tyre inflator tube »» Fig. 41 ⑧ into the tyre valve.
- Check that the air bleed screw is closed »» Fig. 41 ⑥.
- Start the engine and leave it running.
- Insert the connector »» Fig. 41 ⑨ into the vehicle's 12-volt socket »» page 158.
- Turn the air compressor on with the ON/OFF switch »» Fig. 41 ⑤.
- Keep the air compressor running until it reaches 2.0 to 2.5 bar (29-36 psi/200-250 kPa).

A maximum of 8 minutes.

- Disconnect the air compressor.
- If it does not reach the pressure indicated, unscrew the tyre inflator tube from the valve.
- Move the vehicle 10m so that the sealant is distributed throughout the tyre.
- Screw the compressor tyre inflator into the valve.
- Repeat the inflation process.
- If the indicated pressure still cannot be reached, the tyre is too badly damaged. Stop and request assistance from an authorised technician.

- Disconnect the air compressor. Unscrew the tyre inflator tube from the tyre valve.
- When the tyre pressure is between 2.5 and 2.0 bars, continue driving without exceeding 80 km/h (50 mph).
- Attach the sticker »» Fig. 41 ② to the instrument cluster, within the driver's visual field.
- Check the pressure again after 10 minutes »» page 44.

WARNING

When inflating the wheel, the air compressor and the inflator tube may become hot.

- Protect hands and skin from hot parts.
- Do not place the hot flexible inflator tube or hot air compressor on flammable material.
- Allow them to cool before storing the device.
- If it is not possible to inflate the tyre to at least 2.0 bars (29 psi / 200 kPa), the tyre is too badly damaged. The sealant is not in a good condition to seal the tyre. Do not continue driving. Seek specialist assistance.


CAUTION

Switch off the air compressor after a maximum of 8 operational minutes to avoid overheating! Before switching on the air compressor again, let it cool for several minutes.

Check after 10 minutes of driving

Screw the inflator tube »» Fig. 41 ⑤ again and check the pressure on the gauge ⑥.

1.3 bar (19 psi / 130 kPa) and lower:

- **Stop the vehicle!** The tyre cannot be sealed sufficiently with the tyre mobility set.
- You should obtain professional assistance »» .

1.4 bar (20 psi / 140 kPa) and higher:

- Set the tyre pressure to the correct value again.
- Carefully resume your journey until you reach the nearest specialised workshop without exceeding 80 km/h (50 mph).
- Have the damaged tyre replaced.

WARNING

Driving with an unsealed tyre is dangerous and can cause accidents and serious injury.

- Do not continue driving if the tyre pressure is 1.3 bar (19 psi / 130 kPa) and lower.
- Seek specialist assistance.

Changing a wheel

Introduction

The SEAT Alhambra is equipped as standard with anti-puncture technology tyres (Conti-Seal). In the event of a puncture or air leak of up to 5 mm, the tyre seals the hole with a protective layer inside the tread.

The inclusion of this technology means that there is no type of spare wheel included in the vehicle's equipment.

Not all Alhambra models have the TMS (Tyre Mobility System).

If a tyre needs to be changed the tools necessary are available at spare parts dealers:

- Jack,
- box spanner for wheel nuts,
- tool to remove wheel bolt caps

The tyres mounted on the vehicle are anti-puncture. The wheels should only be changed when switching from summer to winter tyres or vice-versa.

The vehicle only comes with the necessary tools for changing wheels if factory supplied with winter tyres. If this is not the case, you need to go to a specialised workshop to get the wheels changed.

What to do first

- Park the vehicle on a horizontal surface and in a safe place as far away from traffic as possible.
- Apply the electronic parking brake.
- Switch on the hazard warning lights.
- *Manual transmission:* select the 1st gear.
- *Automatic transmission:* Move the selector lever to position **P**.
- If you are towing a trailer, unhitch it from your vehicle.
- Keep the vehicle tool kit available »» page 41.
- Observe the applicable legislation for each country (reflective vest, warning triangles, etc.).
- All occupants should leave the vehicle and wait in a safe place (for instance behind the roadside crash barrier).

⚠ WARNING

- **Always observe the above steps and protect yourself and other road users.**
- **If you change the wheel on a slope, block the wheel on the opposite side of the car with a stone or similar to prevent the vehicle from moving.**

Integral wheel trim

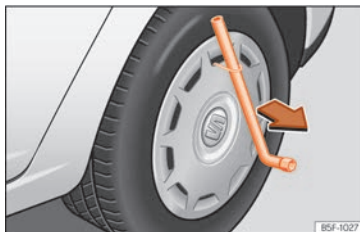


Fig. 42 Remove the wheel cover.

The wheel covers must be removed for access to the wheel nuts.

Removing

- Take the wheel brace and the wire hook from the vehicle tool kit »» page 41.
- Hook the wire through one of the grooves of the trim.
- Insert the box spanner through the hook, rest it on the tyre and remove the wheel trim »» Fig. 42.

Fitting

Before installing the full trim, the anti-theft wheel lock must be threaded into position »» Fig. 46 ② ó ③.

»

- Press the trim against the wheel so that the valve hole is in the same position as the tyre's valve »» Fig. 46 ①. Make sure that the trim is correctly fitted all the way around the wheel.

Wheel bolt caps



Fig. 43 Wheel: wheel nuts with caps.

Removal

- Fit the plastic clip [vehicle tools »» Fig. 39] over the cap until it clicks into place »» Fig. 43.
- Remove the cap with the plastic clip.

The caps protect the wheel nuts and should be remounted after changing the tyre.

The **anti-theft wheel locking bolt** has a special cap. This only fits on anti-theft locking bolts and is not for use with standard wheel nuts.

Anti-theft wheel nuts

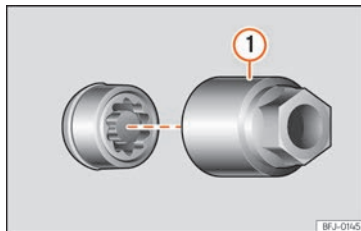


Fig. 44 Anti-theft wheel bolt with cap and adapter.

Loosening the anti-theft wheel bolt

- Remove the wheel cover or the cap.
- Insert the special adapter »» Fig. 44 ① (vehicle tools »» page 41) onto the anti-theft wheel bolt and push it on as far as it will go.
- Insert the wheel brace (vehicle tools) onto the adapter as far as it will go.
- Remove the wheel bolt »» page 46.

i Note

Make a note of the code number of the anti-theft wheel bolt and keep it in a safe place, but not in your vehicle. If you need a new adapter, you can obtain it from the SEAT Official Service, indicating the code number.

Loosening wheel nuts



Fig. 45 Wheel change: loosen the wheel nuts.

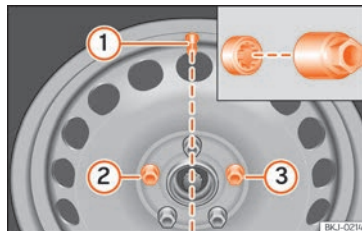


Fig. 46 Wheel change: tyre valve ① and the correct position for the anti-theft wheel locking bolt ② or ③.

Use only the wheel wrench belonging to the car to loosen the wheel nuts.

Loosen the wheel nuts only about one turn before raising the vehicle with the jack.

If the wheel bolt is very tight, carefully push on the end of the wheel wrench with your foot. Hold on to the vehicle for support and take care not to slip during this operation.

Loosening wheel nuts

- Fit the wheel wrench on as far as it will go »» Fig. 45.
- Hold the wrench at the end and rotate the bolt approximately one turn anticlockwise »» ⚠.

Important information about wheel nuts

Factory-fitted rims and wheel nuts are specially matched during construction. Therefore, if different rims are fitted, the correct wheel nuts with the right length and heads must be used. This ensures that wheels are fitted securely and that the brake system functions correctly.

In certain circumstances, you should not even use wheel nuts from vehicles of the same model.

In wheels with full hubcaps, the anti-theft locking bolt must be threaded onto positions »» Fig. 46 ② or ③, taking the tyre valve's position as reference ①. Otherwise it will not be possible to mount the hubcap.

⚠ WARNING

If the wheel nuts are not properly tightened, they could come loose while driving

and cause an accident, serious injury and loss of vehicle control.

- Use only wheel nuts which correspond to the rim in question.
- Never use different wheel nuts.
- Wheel nuts and threads should be clean, free of oil and grease, and it should be possible to screw them easily.
- To loosen and tighten wheel nuts, only use the wheel wrench that came with the car from the factory.
- The wheel nuts should only be loosened slightly (about one turn) before raising the vehicle with the jack. Risk of accident!
- Never apply grease or oil to wheel nuts or to the wheel hub threads. Even if the bolts have been tightened to the prescribed torque, they could come loose while driving.
- Never loosen the screwed joints of wheel rims with bolted ring trims.
- If wheel nuts are tightened below the prescribed torque, the bolts and rims could come loose while driving. If tightening torque is too high, the wheel nuts or threads can be damaged.

Raise the vehicle



Fig. 47 Jack position points.

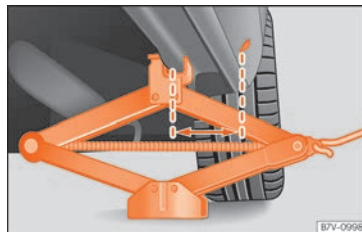


Fig. 48 Jack mounted on the left rear part of the vehicle

- Rest the jack (vehicles tools) on firm ground. If necessary use a large, strong board or similar support. If the surface is slippery (for example tiles) place the jack on a rubber mat or similar to prevent it from slipping »» ⚠.

»

- Block the wheel diagonally opposite the wheel being changed with folding wheel chocks or other suitable objects.
- Find the support point on the strut (sunken area) closest to the wheel to be changed »» Fig. 47.
- Turn the jack crank handle, located below the strut support point, to raise it until the tab »» Fig. 48 is below the housing that is provided.
- Align the jack so that the tab “grips” onto the housing provided on the cross member and the mobile base is resting on the ground. The base plate 2 should fall vertically with respect to the support point.
- Continue turning the jack until the wheel is slightly lifted off the ground.

⚠ WARNING

The factory-supplied jack is only designed for changing wheels on this model. On no account attempt to use it for lifting heavier vehicles or other loads. Risk of injury.

- Make sure the jack remains stable. If the surface is slippery or soft, the jack could slip or sink, respectively, with the consequent risk of causing injuries.
- Lift the vehicle using only the jack supplied from the factory. Other jacks, even those approved for other SEAT models could slip, with the consequent risk of injury.

- Place the jack only at the support points provided on the strut and align it. Otherwise, the jack could slip because it does not have sufficient grip on the vehicle: risk of injury!
- You should never place a body limb such as an arm or leg under a raised vehicle that is solely supported by the jack.
- If you have to work underneath the vehicle, you must use suitable stands additionally to support the vehicle, there is a risk of accident!.
- Never raise the vehicle if it is tilting to one side or the engine is running.
- Never start the engine when the vehicle is raised. The vehicle may come loose from the jack due to the engine vibrations.

ⓘ CAUTION

The vehicle must not be raised on the crossbar. Place the jack only at the support points provided on the strut and align it. Otherwise, the vehicle may be damaged.

Removing and installing a wheel



Fig. 49 Wheel change: loosen wheel nuts with the socket in the handle of the screwdriver.

Change the wheel after loosening the wheel nuts and raising the vehicle with the jack.

When removing/fitting the wheel, the rim may hit and damage the brake disc. For this reason, please take care and get a second person to assist you.

Taking off the wheel

- Using the hexagonal socket in the wheel brace »» Fig. 49, unscrew the slackened wheel nuts and place them on a clean surface.
- Unscrew the wheel nuts using the box spanner and place them on a clean surface.
- Take off the wheel.

Putting on the spare wheel

Check the direction of rotation of the tyre
»» page 49.

- Place the spare wheel or temporary spare wheel into position.
- Replace the wheel bolts and tighten *slightly* using the hexagonal socket on the end of the wheel brace.
- To tighten the anti-theft locking wheel nuts use the corresponding adaptor.
- Carefully lower the vehicle using the jack.
- Use the wheel spanner to tighten all of the wheel nuts clockwise. Tighten the bolts in diagonal pairs (not in a circle).
- Put the caps, trim or full hubcap back on
»» page 45.

The wheel nuts should be clean and turn easily. Before fitting the spare wheel, inspect the wheel condition and hub mounting surfaces. These surfaces must be clean before fitting the wheel.

Tightening torque of the wheel nuts

The recommended tightening torque for wheel nuts for steel and alloy wheels is **140 Nm**. After changing a wheel, have the tightening torque checked immediately with a torque wrench that is working perfectly.

Before checking tightening torque, have any rusty wheel nuts that are difficult to screw replaced and clean the wheel hub threads.

Never apply grease or oil to wheel nuts or to the wheel hub threads. Even if the bolts have been tightened to the prescribed torque, they could come loose while driving.

WARNING

The hexagonal socket in the wheel brace should be used for turning wheel nuts only. Do not use it to loosen or tighten the wheel nuts.

Tyres with directional tread pattern

Tyres with directional tread pattern have been designed to operate best when rotating in only one direction. An arrow on the tyre sidewall indicates the direction of rotation on tyres with directional tread. Always observe the indicated direction of rotation in order to guarantee optimum grip and help avoid aquaplaning, excessive noise and wear.

If the tyre is mounted in the opposite direction of rotation, drive with extreme caution, as the tyre is no longer being used correctly. This is of particular importance when the road surface is wet. Change the tyre as soon as possible or remount it with the correct direction of rotation.

Works after changing a wheel

- *Alloy wheels*: replace the wheel bolt caps.
- *Plate wheels*: replace the wheel hubcap .
- Return all tools to their proper storing location.
- If the replaced wheel does not fit in the spare wheel housing, store it safely in the luggage compartment »» page 140.
- Check the tyre pressure of the newly mounted tyre as soon as possible.
- In vehicles fitted with a tyre pressure indicator, adjust the pressure and store it in memory »» page 334.
- Have the tightening torque of the wheel nuts checked as soon as possible with a torque wrench »» page 49. Meanwhile, drive carefully.
- Have the flat tyre replaced as quickly as possible.

Changing the windscreen wiper blades

Wiper service position

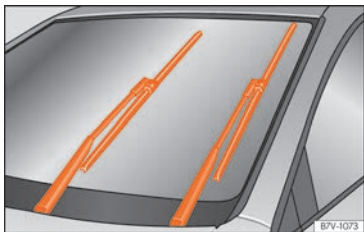


Fig. 50 Wipers in service position.

Ensure that the wiper blades are not frozen.

The wiper arms can be raised when the wipers are in service position »»» **Fig. 50**.

- Close the bonnet »»» **page 315**.
- Switch the ignition on and off.
- Press the windscreen wiper lever downwards briefly »»» **page 125** **4**.

Before driving, always lower the wiper arms. Using the windscreen wiper lever, the windscreen wiper arms return to their initial position.

Note

- The windscreen wiper arms can be moved to the service position only when the bonnet is properly closed.
- You can also use the service position, for example, if you want to fix a cover over the windscreen in the winter to keep it clear of ice.

Changing the wiper rear wiper blades

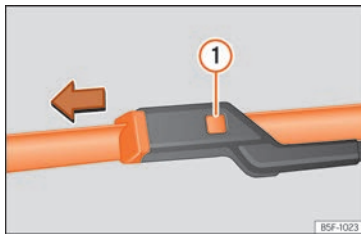


Fig. 51 Changing the windscreen wiper blades

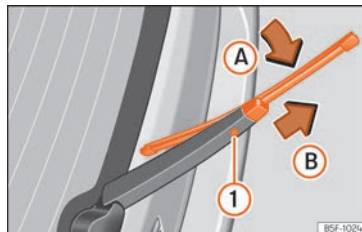


Fig. 52 Changing the rear wiper blade

The windscreen wiper blades are supplied as standard with a layer of graphite. This layer is responsible for ensuring that the wipe is silent. If the graphite layer is damaged, the noise of the water as it is wiped across the windscreen will be louder.

Check the condition of the wiper blades regularly. **If the wipers scrape across the glass**, they should be changed if they are damaged, or cleaned if they are dirty »»» **1**.

If this does not produce the desired results, the setting angle of the windscreen wiper arms might be incorrect. They should be checked by a specialised workshop and corrected if necessary.

Damaged windscreen wiper blades should be replaced immediately. These are available from qualified workshops.

Raising and lowering windscreen wiper arms

- Place the windscreen wipers in the service position »» page 50.
- Grip the wiper arms **only** by the blade's fastening point.

Cleaning windscreen wiper blades

- Raise the wiper arms.
- Use a soft cloth to remove dust and dirt from the windscreen wiper blades.
- If the blades are very dirty, a sponge or damp cloth may be used »» ❶.

Changing the windscreen wiper blades

- Lift and unfold the wiper arms.
- Press and hold release button »» Fig. 51 ❶ and pull gently on the wiper blade in the direction of the arrow.
- Fit a new wiper blade of the **same length and design** on to the wiper arm and hook it into place.
- Rest the wiper arms back onto the windscreen.

Changing the rear wiper blade

- Lift and fold the wiper arm.
- Turn the blade slightly »» Fig. 52 (arrow ❸).

- Hold down the release button ❶ while gently pulling the blade in the direction of arrow ❷.
- Insert a new blade of the **same length and type** in the rear wiper arm in the opposite direction to the arrow ❷ and hook into place button ❶.
- Replace the wiper arm on the rear window.

⚠ WARNING

Worn or dirty windscreen wiper blades reduce visibility and increase the risk of accident and serious injury.

- **Always replace damaged or worn windscreen wiper blades or blades that no longer clean the windscreen properly.**

❗ CAUTION

- **Damaged or dirty windscreen wipers could scratch the glass.**
- **If products containing solvents, rough sponges or sharp objects are used to clean the blades, the graphite layer will be damaged.**
- **Never use fuel, nail varnish remover, paint thinner or similar products to clean the windows.**
- **In icy conditions, always check that the wiper blades are not frozen to the glass before using the wipers. In cold weather, it may help to leave the vehicle parked with the wipers in service position »» page 50.**

❗ CAUTION

- **To prevent damage to the bonnet and the wiper arms, only leave them in the service position.**
- **Before driving, always lower the wiper arms.**

Jump start

Jump leads

The jump lead must have a sufficient wire cross section.

If the engine fails to start because of a discharged battery, the battery can be connected to the battery of another vehicle to start the engine.

Jump leads must comply with standard **DIN 72553** (see cable manufacturer's instructions). The wire cross section must be at least 25 mm² for petrol engines and at least 35 mm² for diesel engines.

For vehicles whose battery is not in the engine compartment, the jump leads should only be connected to the starting assistance connection points in the engine compartment. »»

i Note

- The vehicles must not touch each other, otherwise electricity could flow as soon as the positive terminals are connected.
- The discharged battery must be properly connected to the on-board network.

Positive pole at the jump start points

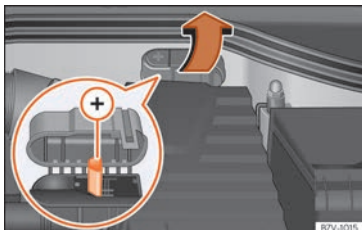


Fig. 53 In the engine compartment: jump start positive pole (+).

On some vehicles, there is a starting assistance terminal in the engine compartment, under a labelled cover.

Jump start: description

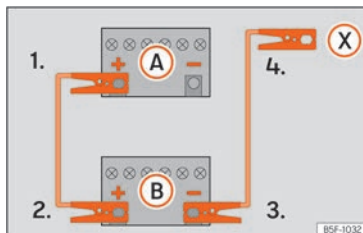


Fig. 54 Diagram of connections for vehicles without Start Stop system

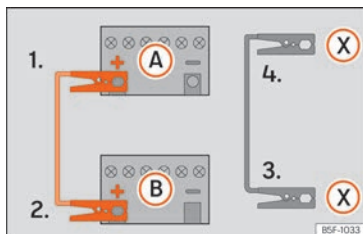


Fig. 55 Diagram of connections for vehicles with Start Stop system

Jump lead terminal connections

1. Switch off the ignition of both vehicles
» » » **△**.

2. Connect one end of the red jump lead to the positive (+) terminal of the vehicle with the flat battery (A) » » » Fig. 54.
3. Connect the other end of the red jump lead to the positive terminal (+) in the vehicle providing assistance (B).
- 4a. *In vehicles without a Start-Stop system:* connect one end of the black jump lead to the negative terminal (-) of the vehicle providing the current (B) » » » Fig. 54.
- 4b. *In vehicles with a Start-stop system:* connect one end of the black jump lead (X) to a suitable ground terminal, to a solid piece of metal in the engine block, or to the engine block itself » » » Fig. 55.
5. Connect the other end of the black jump lead (X) to a solid metal component bolted to the engine block or to the engine block itself of the vehicle with the flat battery. Do not connect it to a point near the battery (A).
6. Position the leads in such a way that they cannot come into contact with any moving parts in the engine compartment.

Starting

7. Start the engine of the vehicle with the boosting battery and let it run at idling speed.

- Start the engine of the vehicle with the flat battery and wait for 2 or 3 minutes until the engine is running.

Removing the jump leads

- Before you remove the jump leads, switch off the dipped beam headlights if they are switched on.
- Turn on the heater blower and heated rear window in the vehicle with the flat battery. This helps minimise voltage peaks which are generated when the leads are disconnected.
- When the engine is running, disconnect the leads in reverse order to the details given above.

Make sure the battery clamps have sufficient metal-to-metal contact with the battery terminals.

If the engine fails to start after about 10 seconds, switch off the starter and try again after about 1 minute.

WARNING

- Please note the safety warnings referring to working in the engine compartment » page 315.
- The battery providing assistance must have the same voltage as the flat battery (12V) and approximately the same capaci-

ty [see imprint on battery]. Failure to comply could result in an explosion.

- Never use jump leads when one of the batteries is frozen. Danger of explosion! Even after the battery has thawed, battery acid could leak and cause chemical burns. If a battery freezes, it should be replaced.
- Keep sparks, flames and lighted cigarettes away from batteries, danger of explosion. Failure to comply could result in an explosion.
- Observe the instructions provided by the manufacturer of the jump leads.
- Do not connect the negative cable from the other vehicle directly to the negative terminal of the flat battery. The gas emitted from the battery could be ignited by sparks. Danger of explosion.
- Never attach the negative cable to fuel system components or the brake lines in the other vehicle.
- The non-insulated parts of the battery clamps must not be allowed to touch. The jump lead attached to the positive battery terminal must not touch metal parts of the vehicle, this can cause a short circuit.
- Position the leads in such a way that they cannot come into contact with any moving parts in the engine compartment.
- Do not lean on the batteries. This could result in chemical burns.

Note

The vehicles must not touch each other, otherwise electricity could flow as soon as the positive terminals are connected.

Tow start and towing

Introduction

Tow-starting means starting the engine of the vehicle while another pulls it.


Towing means one vehicle pulling another that is not roadworthy.

Always consider the legal provisions relating to tow-starting and towing.

For technical reasons, towing a vehicle with a discharged battery is not allowed. The jump start should be used instead » page 51.

If the vehicle comes with the Keyless Access system, towing is only allowed with the ignition on!

The vehicle battery drains if the vehicle is towed with the engine switched off and the ignition connected. Depending on the battery charge status, the drop in voltage may be so large, even after just a few minutes, that no electrical device in the vehicle may work e.g. the hazard warning lights. In vehicles with the »

Keyless Access system, the steering wheel could lock »» .

WARNING

A vehicle with no power should never be towed.

- When towing, never remove the ignition key or disconnect the ignition with the start button. Otherwise, the electronic lock of the steering column could suddenly become blocked and it would be impossible to steer the vehicle. This could cause an accident, serious injury and loss of control of the vehicle.
- If during towing the vehicle runs out of power, stop towing immediately and request the assistance of specialist personnel.

WARNING

Vehicle handling and braking capacity change considerably during towing. Please observe the following instructions to minimise the risk of serious accidents and injury:

- As the driver of the vehicle being towed:
 - You should depress the brake much harder as the brake servo does not operate. Pay the utmost attention to avoid crashing into the towing vehicle.
 - More strength is required at the steering wheel as the power steering does

not operate when the engine is switched off.

- As the driver of the towing vehicle:
 - Accelerate with particular care and caution.
 - Avoid sudden braking and manoeuvres.
 - Brake earlier than usual and more smoothly.

CAUTION

- To avoid damaging the vehicle, for example the paint, remove and replace the lid and towing eye carefully.
- Unburnt fuel could enter the catalytic converter and damage it during towing.

Instructions for tow-starting

Vehicle's should not generally be tow-started. The jump start should be used instead »» page 51.

For technical reasons, towing the following vehicles is **not** allowed:

- Vehicles with an automatic gearbox.
- If the vehicle battery is discharged, because in vehicles with the Keyless Access locking and ignition system the steering remains locked and the electronic parking brake cannot be deactivated nor can the

electronic lock of the steering column be released if they are activated.

- If the battery is flat, it is possible that the engine control units may not operate correctly.

However, if the vehicle must absolutely be tow-started (in the case of manual gear-boxes):

- Engage the 2nd or 3rd gear.
- Keep the clutch pressed down.
- Switch on the ignition and the hazard warning lights of both vehicles.
- Once both vehicles are moving, release the clutch.
- Once the engine starts, press the clutch and disengage the gear to avoid colliding with the towing vehicle.

CAUTION

- When tow-starting, unburnt fuel could enter the catalytic converter and damage it.
- Do not tow a vehicle for more than 50 m in attempt to start it. There is risk of damage to the catalytic converter.

Note

The vehicle can only be jump-started if the electronic parking brake and, if appropriate, the electronic lock of the steering

column are deactivated. If the vehicle has no power supply or there is an electric system fault, the engine must be jump-started to deactivate the electronic parking brake and the electronic lock of the steering column.

Towing instructions

Towing requires some expertise and experience, especially when using a tow rope. Both drivers should be familiar with the difficulties involved in towing. For this reason, inexperienced drivers should abstain from towing.

During towing, it should be ensured that no impermissible tractive forces or shocks are generated. When towing on an unpaved road, there is always a risk of overloading and damaging the anchorage points.

During towing, the towing vehicle can signal the change of direction even with the hazard warning lights turned on. To do so, at the same time, the turn signal lever must be operated with ignition switched on. Meanwhile, the hazard warning lights will go off. When the turn signal lever is returned to the rest position, the hazard warning lights will be automatically reactivated.

Notes for the driver of the towed vehicle

- Leave the ignition on, so that the steering is not blocked, and the electronic parking brake may be deactivated and the turn signals and wash/wipe operated.
- More strength is required at the steering wheel as the power steering does not operate when the engine is switched off.
- You should depress the brake much harder as the brake servo does not operate. Avoid hitting the towing vehicle.
- Bear in mind the information and instructions in the manual of the vehicle to be towed.

Notes for the driver of the towing vehicle

- Accelerate with particular care and caution. Avoid sharp manoeuvres.
- Brake earlier than usual and smoothly.
- Bear in mind the information and instructions in the manual of the towed vehicle.

Tow rope or tow bar

It is safer for the vehicle to be towed using a tow bar, avoiding damage to the vehicle. A tow rope should only be used if a tow bar is not available.

A tow rope should be slightly elastic to avoid damage to both vehicles. It is advisable to use a tow rope made of synthetic fibre or similarly elastic material.

Only attach the tow rope or the tow bar to the towing eyes provided or a towing bracket.

If the vehicle has a **factory-fitted towing device**, towing with a tow bar is **only** permitted if it has been specially designed to be installed on a tow hitch » **page 301**.

When the vehicle has to be towed:

Check whether the vehicle may be towed » **page 56, Cases where towing the vehicle is not permitted**.

The vehicle can be towed using a tow bar or tow rope in the normal way, with all four wheels on the road; it can also be towed with either the front or rear wheels lifted off the road.

- Switch the ignition on.
- Put the gearbox lever in neutral or the selector lever in the **N** » **page 247** position.
- Do not allow the vehicle to be towed at speeds of over 50 km/h (30 mph).
- The vehicle must not be towed further than 50 km (30 miles).
- If a breakdown lorry is used, vehicles with automatic transmission are only allowed to be towed with the front wheels suspended. »

Towing vehicles with four-wheel drive (4Drive)

Four-wheel drive vehicles (4Drive) can be towed using a tow bar or tow rope. If the vehicle is towed with the front or rear axle suspended, the engine must be switched off, otherwise the transmission may be damaged.

Cases where towing the vehicle is not permitted

- If, due to a fault, the gearbox is out of lubricant.
- If the vehicle battery is discharged, because the steering remains locked and, if appropriate, the electronic parking brake cannot be deactivated or the electronic lock of the steering column released.
- If a distance above 50 km needs to be travelled.
- When, for example, after an accident, the smooth rotation of the wheels or the steering operation cannot be guaranteed.

When the vehicle is to tow another vehicle:

- Observe legal requirements.
- Keep in mind the instructions in the manual on towing vehicles.

ⓘ CAUTION

If there is no oil in the gearbox or no lubricant in the automatic transmission the car

may only be towed with the driven wheels lifted clear of the road, or transported on a special car transporter or trailer.

ⓘ Note

The vehicle can only be towed if the electronic parking brake and the electronic lock of the steering column are deactivated. If the vehicle has no power supply or there is an electric system fault, the engine must be jump-started »» page 51 to deactivate the electronic parking brake and the electronic lock of the steering column.

Front towline anchorage



Fig. 56 On the right side of the front bumper: screw in the towline anchorage

The housing of the removable towline anchorage is on the right side of the front bumper underneath a cover.

The towing eye should always be kept in the vehicle.

Bear in mind the instructions for towing »» page 55.

Fitting the towline anchorage

- Remove the towing eye from the vehicle tool kit in the luggage compartment »» page 41.
- Remove the cover by pressing down on the top and leave it hanging from the vehicle.
- Screw the towing eye in the housing by turning it as far as it will go **anticlockwise** »» Fig. 56 »» ⓘ. Use a suitable object that can completely and securely tighten the towing eye in its housing.
- After towing, unscrew the towing eye **clockwise** with a suitable object.
- Insert the upper flange of the lid into the opening of the bumper and press the lower side of the lid until it is inserted into the bumper.
- Clean the towing eye if necessary and then store it in the luggage compartment along with the other vehicle tools.

ⓘ CAUTION

The towing eye must always be completely and firmly tightened. Otherwise, it could be released while towing and tow-starting.

Make sure that there are no objects that prevent the eyebolt being screwed.

Rear towline anchorage

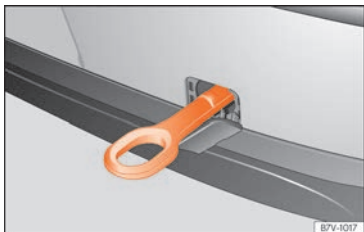


Fig. 57 On the right side of the rear bumper: towline anchorage in position.

The housing of the screw towing eye is on the right side of the rear bumper behind a lid » **Fig. 57**.

Vehicles equipped as standard with a towing bracket **do not** have any housing for the screw towing eye behind the lid. In this case, the tow hitch needs to be extracted or installed and used for towing » **page 301**, » **!**.

Bear in mind the instructions for towing » **page 55**.

Assemble the rear towing eye (cars without a factory-equipped towing bracket)

- Remove the towing eye from the vehicle tool kit in the luggage compartment » **page 41**.
- Press the upper side of the lid » **Fig. 57** to unclip it.
- Remove the lid and let it hang from the vehicle.
- Screw the towline anchorage into the housing by turning it as far as it will go **anticlockwise** » **!**. Use a suitable object that can completely and securely tighten the towing eye in its housing.
- After towing, unscrew the towing eye **clockwise** with a suitable object.
- Insert the upper flange of the lid into the opening of the bumper and press the lower side of the lid until the upper flange is inserted into the bumper.
- Clean the towing eye if necessary and then store it in the luggage compartment along with the other vehicle tools.

! CAUTION

- The towing eye must always be completely and firmly tightened. Otherwise, it could be released while towing and tow-starting.
- If the vehicle is factory-equipped with a towing bracket, it is only allowed to tow

with a tow bar if this has been specially designed to be installed with a tow hitch. If an unsuitable tow bar is used, both the tow hitch and the vehicle may be damaged. Instead, a tow rope should be used.

Fuses and bulbs

Fuses

Introduction

In general, a fuse can be assigned to various electrical components. Likewise, an electrical component can be protected by several fuses.

Only replace fuses when the cause of the problem has been solved. If a newly inserted fuse blows after a short time, you must have the electrical system checked by a specialised workshop as soon as possible.

⚠ WARNING

The high voltages in the electrical system can give serious electrical shocks, causing burns and even death!

- Never touch the electrical wiring of the ignition system.
- Take care not to cause short circuits in the electrical system.

⚠ WARNING

Using unsuitable fuses, repairing fuses or bridging a current circuit without fuses can cause a fire and serious injury.

- Never use a fuse with a higher value. Only replace fuses with a fuse of the same am-

perage (same colour and markings) and size.

- Never replace a fuse by a metal strip, staple or similar.

ⓘ CAUTION

- To prevent damage to the vehicle's electric system, before replacing a fuse always turn off the ignition, the lights and all electrical elements and remove the key from the ignition.
- Protect the fuse boxes when open to prevent the entry of dust or humidity as they can damage the electrical system.

ⓘ Note

- One component may have more than one fuse.
- Several components may run on a single fuse.
- In the vehicle, there are more fuses than those indicated in this chapter.

Fuses inside the vehicle



Fig. 58 On the driver's side dashboard: fuse box cover.

Opening and closing the fuse box situated below the dash panel

- To remove the cover, move the activation lever in the lower part to the right »» Fig. 58.
- For right-hand drive vehicles, move the lever to the left.

Identifying fuses below the dashboard by colours

Colour	Amp rating
Black	1
Purple	3
Light brown	5
Brown	7.5

Colour	Amp rating
Red	10
Blue	15
Yellow	20
White or transparent	25
Green	30
Orange	40

ⓘ CAUTION

- Always carefully remove the fuse box covers and refit them correctly to avoid problems with your vehicle.
- Protect the fuse boxes when open to avoid the entry of dust or humidity. Dirt and humidity inside fuse boxes can cause damage to the electrical system.

Fuses in the engine compartment

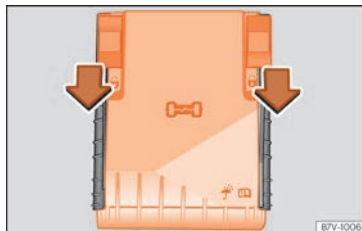


Fig. 59 In the engine compartment: fuse box cover.

To open the engine compartment fuse box

- Open the bonnet » page 315.
- Move the attachment tabs forwards, in the direction indicated by the arrow to release the fuse box cover » **Fig. 59**.
- Then lift the cover out.
- To **fit** the cover, place it on the fuse box. Push the attachment tabs back, in the opposite direction indicated by the arrow until they click audibly into place.

It is possible that there are more fuses behind a cover in the lower left-hand side of the luggage compartment.

Replace a blown fuse

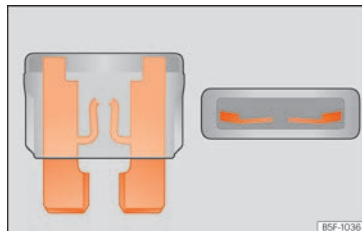


Fig. 60 Image of a blown fuse.

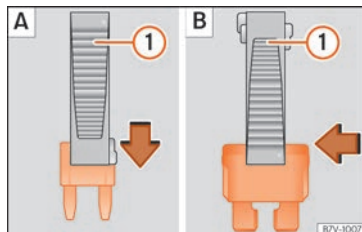


Fig. 61 Removing or fitting a fuse

Preparations

- Switch off the ignition, lights and all electrical equipment.
- Open the corresponding fuse box » page 58, » page 59.

»

Recognise a blown fuse

A fuse is blown if its metal strip is ruptured »» Fig. 60.

- Point a lamp at the fuse to see if it has blown.

To replace a fuse

- If necessary, remove the plastic pincers from the fuse box cover.
- *Small fuses:* fit the pincer in from above »» Fig. 61 A.
- *Large fuses:* move the pincer sideways over the fuse »» Fig. 61 B.
- Remove the fuse.
- Replace the blown fuse by one with an *identical* amperage rating (same colour and markings) and *identical* size.
- Replace the cover again or close the fuse box lid.

Changing bulbs

Introduction

Changing bulbs requires a certain degree of practical skill. If you are unsure, SEAT recommends that you consult a technical service or request assistance from a specialist. In general a specialist is needed if, in addition to the

bulbs, other vehicle components require removal.

If you choose to change the engine compartment lamps yourself, remember that it is a dangerous area »» **⚠ in Working in the engine compartment on page 315.**

Always use identical bulbs with the same designation. The name can be found on the base of the bulb holder.

Bulbs (12 V)

Full-LED headlights are designed to last the lifetime of the car and light bulbs cannot be replaced. In case of headlight failure, go to an authorised workshop to have it replaced.

Light source used for each function

Halogen headlights.	Type
Dipped beam headlights	H7 LL
Main beam headlights/day-time running lights (DRL)	H15 (double element)
Side lights	W5W
Turn signal	PY21W NA LL
AFS bi-xenon main headlight	Type
Daytime running lights (DRL)	P21W SLL
Side lights	W5W

AFS bi-xenon main headlight	Type
Turn signal	PY21W NA LL
Dipped beam / Main beam	Xenon bulb. Visit an authorised workshop for replacement.
Front fog light	Type
Fog lights	HB4
LED rear lights	Type
Side/brake light	LED
Turn signal	WY21W
Reverse lights	W16W

⚠ WARNING

- **Take particular care when working on components in the engine compartment if the engine is warm. Risk of burns.**
- **Bulbs are highly sensitive to pressure. The glass can break when you touch the bulb, causing injury.**
- **When changing bulbs, please take care not to injure yourself on sharp edges, in particular on the headlight housing.**

ⓘ CAUTION

- Remove the ignition key before working on the electric system. Otherwise, a short circuit could occur.
- Switch off the lights and the parking light before changing a bulb.
- Take good care to avoid damaging any components.

♻️ For the sake of the environment

Please ask your specialist retailer how to dispose of used bulbs in the proper manner.

ⓘ Note

- Please check at regular intervals that all lighting (especially the exterior lighting) on your vehicle is functioning properly. This is not only in the interest of your own safety, but also that of all other road users.
- Before changing a bulb, make sure you have the correct new bulb.
- Do not touch the glass part of the bulb with your bare hands, use a cloth or paper towel instead, since the fingerprints left on the glass will vaporise as a result of the heat generated by the bulb, they will be deposited on the reflector and will impair its surface.
- Depending on the level of equipment fitted in the vehicle, LEDs may be used for part or all of the interior and/or exterior lighting. LEDs have an estimated life that

exceeds than that of the car. If an LED light fails, go to an authorised workshop for its replacement.

Replacing the halogen headlight bulbs

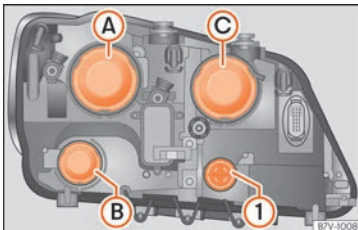


Fig. 62 In the engine compartment: coatings on the left headlight.

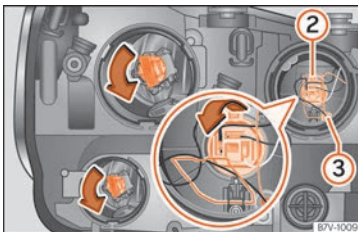


Fig. 63 Left headlight.

- Ⓐ Dipped beam headlights
- Ⓑ Daytime running lights
- Ⓒ Main beam headlight and side light
- ① Turn signals

There is no need to remove the headlight to replace bulbs.

Complete operations only in the sequence given:

Turn signals (small bulb holder)

- Open the bonnet ⚠️.
- Rotate the bulb holder » Fig. 62 ① all the way to the left and pull it out backwards together with the bulb.
- Depending on the model, the bulb is removed directly from the bulb holder or it may need to be rotated and then removed.
- Replace the faulty bulb with a new identical bulb.
- Place the bulb holder in the headlight and rotate to the right all the way.

Ⓐ Dipped beam headlights and Ⓑ Daytime running lights

- Open the bonnet ⚠️.
- Remove the rubber cover on the rear of the headlight.

»

- Rotate the bulb holder to the left all the way and pull it out backwards together with the bulb.
- Depending on the model, the bulb is removed directly from the bulb holder or it may need to be rotated and then removed.
- Replace the faulty bulb with a new identical bulb.
- Place the bulb holder in the headlight and rotate to the right all the way.
- Insert the rubber cover.

Ⓢ Main beam headlights

- Open the bonnet .
- Remove the rubber cover on the rear of the headlight.
- Press the wire clip downwards and pull the bulb holder Fig. 63 out together with the bulb.
- Depending on the model, the bulb is removed directly from the bulb holder or it may need to be rotated and then removed.
- Replace the faulty bulb with a new identical bulb.
- Place the bulb holder in the headlight and pull the wire clip upwards until it clicks into place.
- Insert the rubber cover.

Ⓢ Side light

- Open the bonnet .
- Remove the rubber cover on the rear of the headlight.
- Pull the bulb holder Fig. 63 out backwards together with the bulb.
- Depending on the model, the bulb is removed directly from the bulb holder or it may need to be rotated and then removed.
- Replace the faulty bulb with a new identical bulb.
- Place the bulb holder in the headlight and insert completely.
- Insert the rubber cover.

Note

The images show the left hand headlight from behind. The structure of the right hand side headlight is symmetric.

Replacing the xenon headlight bulbs

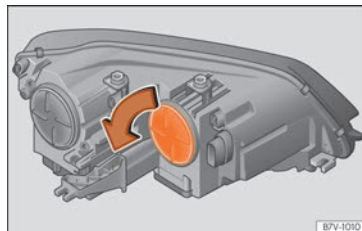


Fig. 64 In the engine compartment: turn signal cover.

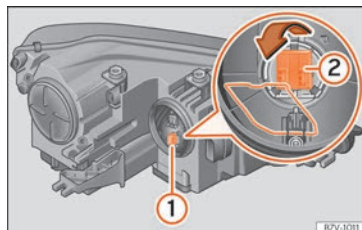









Fig. 65 Turn signal bulb holder and turning light .






There is no need to remove the headlight to replace bulbs.



Complete operations only in the sequence given:


① Turn signal

- Open the bonnet .
- Rotate the cover   in the direction of the arrow and remove it.
- Rotate the bulb holder   ① all the way to the left and pull it out backwards together with the bulb.
- Depending on the model, the bulb is removed directly from the bulb holder or it may need to be rotated and then removed.
- Replace the faulty bulb with a new identical bulb.
- Place the bulb holder in the headlight and rotate to the right all the way.
- Rotate the cover   in the opposite direction to the arrow as far as it will go.

② Cornering light

- Open the bonnet .
- Rotate the cover   in the direction of the arrow and remove it.
- Press the wire clip downwards and pull the bulb holder  ②  out together with the bulb.
- Depending on the model, the bulb is removed directly from the bulb holder or it may need to be rotated and then removed.
- Replace the faulty bulb with a new identical bulb.

- Place the bulb holder in the headlight and pull the wire clip upwards until it clicks into place.
- Rotate the cover   in the opposite direction to the arrow as far as it will go.


Always seek the help of a specialist when changing the Xenon dipped beam and main beam headlamps  in Introduction on page 60.

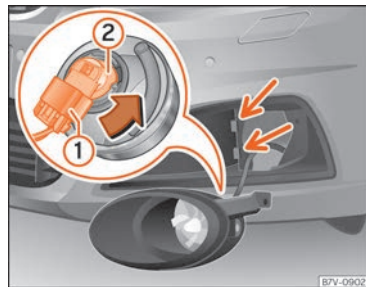
Note


The illustrations show the left hand headlight. The structure of the right hand side headlight is symmetric.

Replacing the front bumper bulb















 On the right side of the front bumper: disassembling the headlights.



 Changing the bulbs in the headlights

Complete operations only in the sequence given:

- Pull the cover forwards, in the direction of the arrow  .
- Unscrew the attachment screw   ① using the screwdriver from the vehicle tool kit  page 41.
- Tilt the headlight slightly forward and extract it from its lateral attachments   (small arrows).
- Release the connector   ① and remove it.
- Rotate the bulb holder   ② to the left all the way, in the direction of the arrow, and pull it out backwards together with the bulb. 

- Replace the faulty bulb with a new identical bulb.
- Place the bulb holder in the headlight and rotate to the right all the way.
- Insert the connector »» Fig. 67 ① on the bulb holder ②. The connector must audibly click into place.
- Place the headlight into its position »» Fig. 67 (small arrows) and tilt it backwards.
- Tighten the attachment screw »» Fig. 66 ① using the screwdriver.
- Replace the cover on the bumper »» Fig. 66.

Replace the rear lid light bulbs

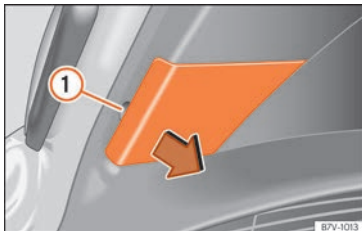


Fig. 68 On the rear lid: remove the cover.

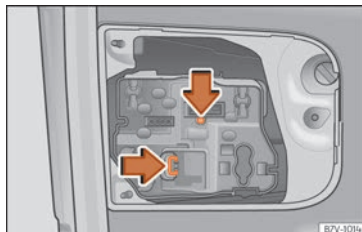


Fig. 69 On the rear lid: remove the bulb holder.

Complete operations only in the sequence given:

- Open the rear lid.
- Extract the cover carefully using the flat part of the screwdriver from the vehicle tool kit as a lever (»» page 41) on the indent »» Fig. 68 ①.
- Release the bulb holder connector by pulling on the red connector block.
- Press on the attachment tabs in the direction of the arrow »» Fig. 69 and pull out the bulb holder.
- Replace the faulty bulb with a new identical bulb.
- Install the bulb holder. The attachment tabs should audibly click into place.
- Insert the cover. The cover should lock into place.

Replacing the tail light bulbs in the bodywork

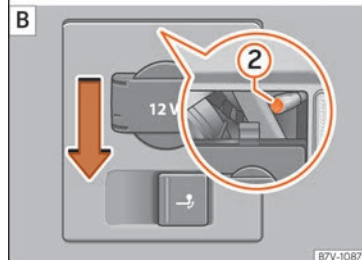
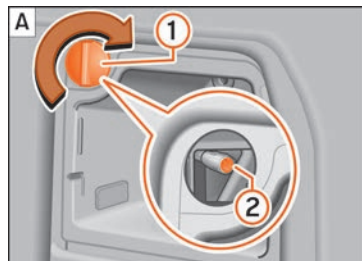


Fig. 70 Side of the luggage compartment: [A] Removing the left tail light unit. [B] Removing the right tail light unit.

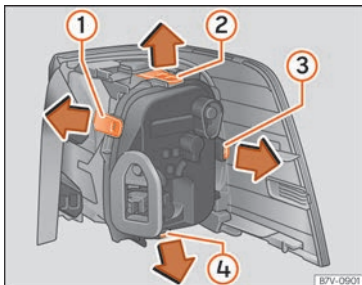


Fig. 71 Tail light unit in the bodywork: removing the bulb holder.

Complete operations only in the sequence given.

Removing the rear light units

- Open the rear lid.
- *Left tail light:* open the storage compartment on the left side of the luggage compartment »» page 152 and then rotate cap »» Fig. 70 ① 90 ° in the direction of the arrow and remove it.
- *Right tail light:* Move the 12 V power socket support by pressing gently downwards »» Fig. 70 [B] (arrow).
- Unscrew the attachment screw »» Fig. 70 ② using the screwdriver from the vehicle tool kit »» page 41. The bolt is secured in its position.

- Extract the rear light from the bodywork by carefully pulling backwards.
- Pull the red strip on the connector and extract the connector.
- Disassemble the tail light unit and place it on a flat, clean surface.

To change the bulb

- To release the bulb holder, press on the attachment tabs »» Fig. 71 ① to ④ in the direction of the arrow.
- Remove the bulb holder from the rear light unit.
- Replace the faulty bulb with a new identical bulb.
- Place the bulb holder in the tail light unit. The attachment tabs should audibly click into place.
- Insert the connector and press the attachment strip in so that the connector is locked into place.

Assembling the rear light units

- Carefully insert the tail light unit into the opening in the bodywork. To do this, insert the upper rear light unit guide into the attachment ring.
- Tighten the white attachment screw using the screwdriver from the vehicle tool kit.

- Ensure that the tail light unit has been correctly fitted and is firmly secured.
- *Left tail light:* replace the cap »» Fig. 70 ① and turn it through 90° in the opposite direction to the arrow. Close the storage compartment.
- *Right tail light:* Move the 12 V power socket support upwards gently until it is properly closed.
- Close the rear lid »» page 107.

Changing the number plate bulbs



Fig. 72 In the rear bumper: Number plate light.

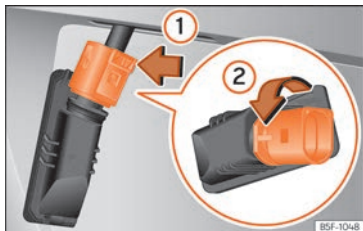


Fig. 73 number plate light: remove the bulb holder.

Follow the steps indicated:

Fixed number plate light

- Use the flat part of the screwdriver included in the vehicle tool kit (» page 41) to press

in the direction of the arrow, in the groove of the number plate light » **Fig. 72**.

- Detach the number plate light.
- Turn the connector lock » **Fig. 73** in the direction of arrow ① and pull on the connector.
- Rotate the bulb holder in the direction of the arrow » **Fig. 73** ② and extract it together with the bulb.
- Replace the faulty bulb with a new identical bulb.
- Insert the bulb holder into the number plate light and rotate all the way in the opposite direction to the arrow » **Fig. 73** ②.
- Plug the connector into the bulb holder.
- Insert the number plate light carefully into the opening on the bumper. Ensure that the number plate light is in the correct position.
- Insert the number plate light into the bumper until it audibly clicks into place.

Bolted number plate light

- Unscrew the number plate light screws using the screwdriver from the vehicle tool kit (» page 41).
- Detach the number plate light.
- Separate the attachment tabs from the rear panel of the number plate light by pressing.

- Take the bulb holder out of the number plate light.
- Replace the faulty bulb with a new identical bulb.
- Insert the bulb holder into the number plate light.
- Press on the attachment tabs. The bulb holder must be firmly attached to the number plate light.
- Insert the number plate light carefully into the opening on the bumper. Ensure that the number plate light is in the correct position.
- Tighten the attachment screws for the number plate light using the screwdriver.

Additional brake light

Taking into account that it consists of LED bulbs, the change should be made at a technical service centre.

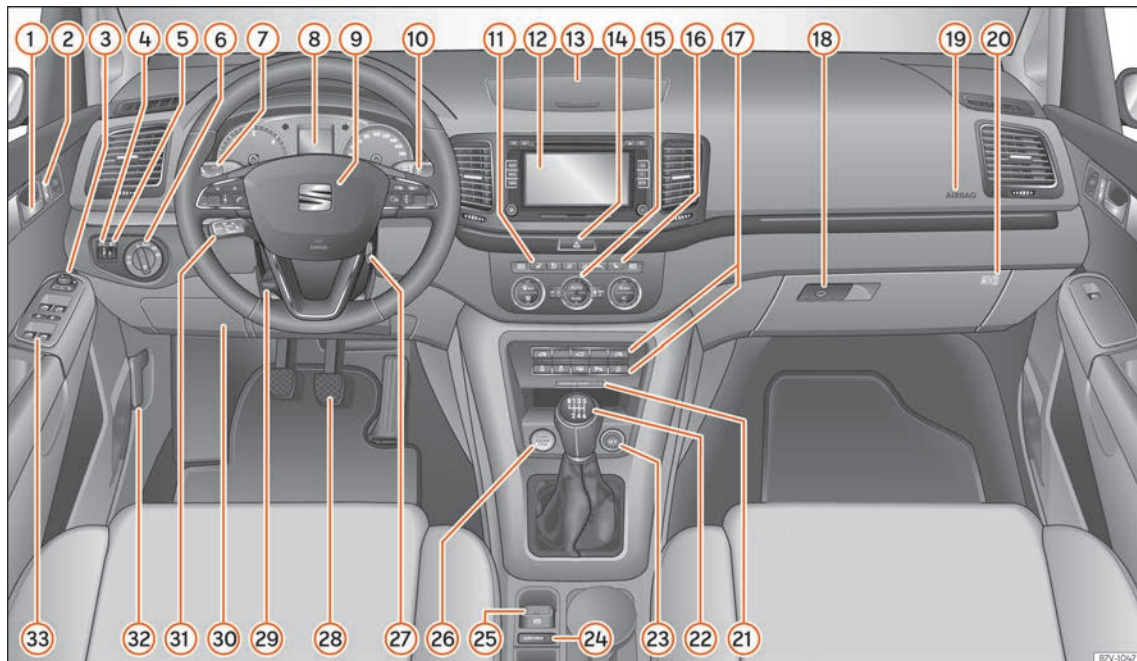


Fig. 74 Instruments and controls.

Operation

Controls and displays

Interior view

Overview

① Interior door handle	
② Central lock button	95
③ Control for the electric adjustment of the exterior mirrors	129
④ Brightness regulation for instrument panel and controls	117
⑤ Headlight range control	117
⑥ Light switch	117
⑦ Lever for:	117
– Turn signals	
– Main beam headlights	
⑧ Instrument panel	71
⑨ Steering wheel with horn and	
– Driver airbag	22
– On-board computer controls	85
– Controls for radio, telephone, navigation and speech dialogue system	172
– Paddle levers for tiptronic gearshift (automatic gearbox)	250
⑩ Control lever for:	
– Windscreen wipers and washer	125
– Wipe and wash system	125
– On-board computer	73
⑪ Left seat heater control	167
⑫ Infotainment system:	172
⑬ Storage compartment	152
⑭ Hazard warning lights switch	122
⑮ Depending on the equipment, controls for:	
– Electronic manual air conditioning	164
– Climatronic	162
⑯ Right seat heater control	167
⑰ Depending on the equipment, buttons for:	
– Anti-slip regulation (ASR)	285
– Start-stop operation	245
– Parking distance warning system (ParkPilot)	294
– Park Assist system	290
– Tyre pressure monitor	334
– Dynamic chassis control (DCC)	255
– The rear lid is opened	107
– Opening and closing of electric sliding doors	105
⑱ Locking handle to open glove compartment	152
⑲ front passenger front airbag	24
⑳ Switch for deactivating the front passenger front airbag	26
㉑ Passenger front airbag off warning lamp	24
㉒ Gear lever for:	
– Manual gearbox	247
– Automatic gearbox	248
㉓ 12 volt power socket	158
㉔ Auto Hold switch	286
㉕ Electronic parking brake switch	285
㉖ Start-up push button (Keyless Access closing and start-up system)	
㉗ Ignition lock	241
㉘ Pedals	15
㉙ Steering column adjustment lever	12
㉚ Fuse box cover	58
㉛ Lever for:	
– Cruise control system (CCS)	262
– Adaptive Cruise Control (ACC)	268
㉜ Open bonnet lever	316
㉝ Electric windows	113 »

i Note

- Some of the equipment listed in this section is only fitted on certain models or are optional extras.
- The arrangement of controls on right-hand drive models may be slightly different from the layout shown in »» page 68. However, the symbols used to identify the controls are the same.

Instruments and warning/control lamps

Instrument panel

Introduction

After switching the engine on with a 12-volt battery that is heavily discharged or newly changed some system settings (such as the time, the date, the personalised comfort settings and the programming) might be altered or deleted. Check and correct these settings once the battery is sufficiently charged.

WARNING

Any distraction may lead to an accident, with the risk of injury.

- Do not operate the instrument panel controls when driving.
- To reduce the risk of accident and injury, only make adjustments to the instructions on the screen of the instrument panel and to the instructions on the screen of the Infotainment system when the vehicle is stationary.

Instrument panel



Fig. 75 Instrument panel, on dash panel.

Details of the instruments »» Fig. 75:

- ① **Time set button** »» page 80.
- ② **Revolutions counter** (with the engine running, in thousands of revolutions per minute) »» page 80.
- ③ **Engine coolant temperature indicator** »» page 82.
- ④ **Displays on the screen** »» page 71.
- ⑤ **Fuel reserve display** »» page 81.
- ⑥ **Speedometer.**
- ⑦ **Reset knob** for trip recorder (**trip**).

Status display

Possible indications on the instrument panel display

Different pieces of information can be displayed on the screen of the instrument panel, depending on the features of the vehicle.

- Doors, bonnet and rear lid open
- Warning and information messages
- Odometer
- Time »» page 80
- Radio, media and navigation system indications
- Indications of the phone
- Outside temperature
- Indications of the compass

- Selector lever positions
- Gear-change recommendation »» page 253
- Display of travel data (multifunction display) and menus for different settings »» page 73
- Service interval display »» page 83
- Second speed indication »» page 72.
- Start-Stop system status display »» page 245
- Signs detected by the traffic signal detection system »» page 78

Doors, bonnet and rear lid open

When the vehicle is unlocked and while driving, the instrument panel display shows if any of the doors, the bonnet or rear lid are

opened and, in some cases, it is also indicated by an audible warning. The display may vary according to the type of instrument panel fitted.

Selector lever positions (DSG® dual clutch gearbox)

The current position of the selector lever is shown on the side of the lever and on the instrument panel display. When the lever is in the **D/S** position or in the Tiptronic position, in some cases, the gear engaged in each case is shown on the instrument panel display.

Outside temperature indicator

If the outside temperature is lower than approximately +4 °C [+39 °F], the “ice crystal symbol” ❄ on the outside temperature display also lights up. This symbol remains lit until the outside temperature exceeds +6 °C [+43 °F] » » ⚠.

When the vehicle is stationary, when the auxiliary heater is switched on or when driving at very low speeds, the outside temperature indicated may be higher than the actual temperature due to the heat produced by the engine.

The margin of measurement ranges from -40 °C [-50 °F] to +50 °C [+122 °F].

Gear-change recommendation

While driving, the instrument panel of certain vehicles may indicate a gear recommendation for saving fuel » » page 253.

Odometer

The *odometer* registers the total distance travelled by the car.

The *partial odometer* (**trip**) shows the distance travelled since the last time it was reset to zero.

• Press button **0.0/SET** » » Fig. 75 ⑦ to reset the trip recorder to 0.

Indications of the compass

With the ignition on and the navigation system on, the cardinal point corresponding to the vehicle's direction of travel is displayed on the instrument panel » » page 83.

Second speed display (mph or km/h)

In addition to the speedometer, the speed can also be displayed in a different unit of measurement (in miles or in km per hour).

To change the units, in the **Settings** menu, select the option **Second speed** » » page 73.

Vehicles without menu display on the instrument panel

• Switch on the engine.

• Press the **0.0/SET** button three times. The odometer display flashes on the instrument panel display.

• Press the key once **0.0/SET**. “mph” or “km/h” is displayed briefly instead of the odometer.

• This activates the second speed display. To switch it off, repeat the procedure.

This option cannot be deactivated in models destined for countries in which the second speed must always be visible.

⚠ WARNING

Even when the outside temperature is higher than freezing temperature, some roads and bridges could be frozen.

• The “ice crystal symbol” indicates that there may be a risk of freezing.

• At outside temperatures above +4 °C [+39 °F], there may be ice even when the “ice crystal symbol” is not on.

• The outside temperature sensor takes a guideline measurement.

📘 Note

• There are different instrument panels and therefore the versions and instructions on the display may vary. In the case of displays without warning or information texts, faults are indicated exclusively by the control warning lamps.

- Some indications on the instrument panel screen may be concealed by a sudden event, e.g. an incoming call.
- If there are several warnings at the same time, the symbols will be displayed one after the other for a few seconds. The symbols will stay on until you remove the cause.

Instrument panel menus

The number of menus and information items available will depend on the vehicle's electronics and features.

A specialised workshop can programme or modify additional functions, according to the vehicle equipment. SEAT recommends visiting a SEAT dealership for this.

Some menu options can only be read when the vehicle is stationary.

- **Multifunction indicator** (driving data) »» page 73
- **Assists** (enable or disable)
 - Sign Assist »» page 78
 - Lane Assist »» page 274
 - Exit Assist
 - Blind spot »» page 277
 - Fatigue detection »» page 77
 - Front Assist »» page 265
- **Audio**


- **Navigation**
- **Telephone**
- **Auxiliary heating** »» page 168
- **Vehicle status** »» page 76
- **Setup** »» page 74

Driving data indicator (multifunction display)

The display of the travel data (multifunction display) shows different values about the journey and the consumption.

Change from one display to another

In vehicles without a multifunction steering wheel:

- Press the rocker switch  on the wiper lever.

In vehicles with a multifunction steering wheel:

- Turn the right thumbwheel of the multifunction steering wheel »» page 85.

Driving data memories

The multifunction display has two automatic memories:



- 1 **Partial memory:** The memory collects journey and consumption data from when the ignition is turned on until when

it is turned off. The memory is automatically deleted if the journey is interrupted for more than 2 hours. If the journey is continued in less than 2 hours after the ignition is switched off, the new data is added to the data already stored in the memory.



- 2 **Total memory:** The memory records the values for a specific number of partial trips, up to a total of 19 hours and 59 minutes or 99 hours and 59 minutes, or 1,999.9 km (or miles) for 9,999 km (or miles), depending on the model of instrument panel. On reaching either of these limits, the memory is automatically erased and starts to count from 0 again.

The selected memory will be shown in the upper right-hand corner of the display.

Changing memory

- With the ignition switched on, and displaying memory 1 or 2, briefly press the  button on the wiper lever or the  on the multifunction steering wheel to switch from one memory to the another

Manually erasing memory 1 or 2

- Select the memory that you wish to erase.
- Hold the  button on the wiper lever or the  button on the multi-function steering wheel down for about 2 seconds.

»

Possible displays

- **Travelling time:** This indicates the hours (h) and minutes (min) since the ignition was switched on.
- **Current fuel consumption:** The current fuel consumption while driving is displayed in l/100 km (or miles per gallon, mpg); when the engine is running but the vehicle is not moving, in l/h (or gallons per hour).
- **Average consumption:** When the ignition is switched on, the average consumption (in l/100 km or in mpg) is displayed after the vehicle has moved approximately 100 metres (328 feet). Otherwise horizontal lines are displayed. The value shown is updated approximately every 5 seconds.
- **Range:** Approximate distance in km (or miles) that can still be travelled with the fuel remaining in the tank, assuming the same style of driving is maintained. This is calculated using the current fuel consumption.
- **Distance travelled:** Distance travelled, after ignition is switched on, in km (or miles).
- **Average speed:** After the ignition is switched on, the average speed will be shown after a distance of approximately 100 metres (328 feet) has been travelled. Otherwise horizontal lines are displayed. The value shown is updated approximately every 5 seconds.
- **Digital speed display:** Current speed displayed digitally.

- **Digital oil temperature display:** Updated engine oil temperature digital display
- **Speed warning at --- km/h:** If the stored speed is exceeded (between 30 - 250 km/h, or 18 - 155 mph), an audible warning is given together with a visual warning.

Storing a speed for the speed warning

- Select the display **Speed warning at --- km/h**.
- Press the button **OK/RESET** on the windscreen wiper lever or the button **OK** on the multifunction steering wheel to store the current speed and activate the warning.
- **Activate:** adjust to the desired speed within 5 seconds using the rocker switch **TRIP** on the windscreen wiper lever or by turning the thumbwheel on the multifunction steering wheel. Next, press the **OK/RESET** or **OK** key again or wait for a few seconds. The speed is stored and the warning activated.
- **Deactivate:** press button **OK/RESET** or button **OK**. The stored speed is deleted.

Personalising the displays

It is possible to select which of the displays in the multifunction display you wish to see on the instrument panel in the **Settings** menu. The units of measurement can also be modified »» page 74.

Settings menu

The number of menus and information items available will depend on the vehicle's electronics and features.

Assistance systems

Settings for different driver assistance systems »» page 86.

Multifunction display data

Configuration of the multifunction display data that you wish to see on the instrument panel display »» page 73.

Compass

Changing the magnetic region and calibrating the compass »» page 83.

Convenience

Changing vehicle convenience functions »» page 75.

Lights and visibility

Configuration of vehicle lighting »» page 75.

Time

Changing the hours and minutes of the instrument panel clock and the navigation system. The time can be displayed in 12 or 24 hour format. The **S** in the upper part of the

display indicates that the clock is set to summer time.

Winter tyres

Changing the visual and audible speed warnings. This function should only be used when the vehicle is fitted with winter tyres, which are not designed for letting the vehicle reach its maximum speed.

Language

Changing the language of the display texts and the navigation system.

Units

Changing the units of measurement for the temperature, consumption and distance.

Second speed

Switching second speed display on and off.

Service

Check the service notifications or reset the service intervals to zero.


Factory settings

Some functions of the **Configuration** menu will be reset to the factory value.

Submenu Convenience

Central locking

- **Auto. lock (Auto Lock):** automatic locking of all doors and boot when reaching a speed of around 15 km/h (10 mph). In order to unlock the vehicle when it is stopped, push the central locking button, pull the door handle or remove the key from the ignition lock if the **Auto unlock** function is enabled.
- **Auto unlock (Auto Unlock):** Unlocking all doors and the boot by removing the ignition key.
- **Unlock door:** when unlocking with the key the following doors are unlocked:

- **All**
- **One door:** only the driver's door unlocks. Pressing the  key a second time unlocks all of the doors and the rear lid.
- **Vehicle side:** the doors on the driver's side are unlocked. In vehicles with the Keyless Access system »» page 95, when the corresponding handle is moved, the doors on the side of the vehicle where the key is located are unlocked.

Handling windows

Window operation settings: this enables the windows to be opened or closed when the vehicle is unlocked or locked respectively.

The open function can only be activated from the driver door »» page 113.

Rear vision mirror adjustment

Tilts passenger mirror downwards when reverse gear is engaged. This enables the driver to see the edge of the pavement, for example »» page 129.

Exterior mirror adjust.

If **synchronised** adjustment is selected, when the driver side exterior mirror is adjusted, the passenger exterior mirror is also moved.

Factory settings

Some functions of the **Convenience** submenu will be reset to the factory value.

Lights and visibility submenu

Coming home and leaving home

This permits the adjustment of the time the headlamps stay on after locking or unlocking the vehicle, the function can also be connected or disconnected here »» page 122.

Footwell light

This permits the adjustment of the brightness of the footwell lighting when the doors are »

open, the function can also be connected or disconnected here

Convenience turn signals

Switching convenience turn signals on and off When the convenience turn signals are connected,, these flash at least three times when the turn signal is switched on »» page 117.

Factory settings

All the configurations in the **Lights & visibility** sub-menu will be reset to the factory settings.

Tourist light

Headlamp adjustment for countries in which vehicles are driven on the other side of the road. When the mark is activated, the headlamps of a left-hand drive vehicle are adjusted for driving on the left. This function must only be used for a short period.

Personal convenience settings

When two people use a vehicle, SEAT recommends that each person always uses "their" own remote control key. When the ignition is switched off, or the vehicle is locked, the personal convenience settings are stored and automatically allocated to the vehicle key.

The values of the personalised convenience settings of the following menu options are allocated to the vehicle key:

- **Parking heating** menu
- **Configuration** Menu
 - Time
 - Language
 - Units
- **Convenience settings** menu
 - Door unlock (individual opening, Auto Lock)
 - Convenience handling of windows
 - Rear vision mirror adjustment
- **Lights & visibility settings** menu
 - Coming home and leaving home
 - Footwell light
 - Convenience turn signals

The stored settings are automatically activated, at the latest when the ignition is switched on. Please refer to the information and tips relating to the seat memory »» page 135.


Warning and information messages (Vehicle status)

The system runs a check on certain components and functions when the ignition is switched on and while the vehicle is moving. Faults displayed on the instrument panel as red and yellow warning symbols accompa-

nied with messages and, depending on the case, even an audible warning »» page 87. The representation of the messages and symbols may vary depending on the version of the instrument panel.

Existing faults can also be checked manually. To do so, open the menu **Vehicle status** or **Vehicle** »» page 73.

Priority 1 warning (red)

The symbol lights up or flashes (in part accompanied by audible warnings).  **Stop driving!** Danger! Check the fault and eliminate the cause. If necessary, seek professional assistance.

Priority 2 warning (yellow)

The symbol lights up or flashes (in part accompanied by audible warnings). Operating faults or the lack of operating fluids can cause damage to the vehicle or a fault. Check the faulty function as soon as possible. If necessary, seek professional assistance.

Information message

It provides information about processes in the vehicle.

Driver alert system (break recommendation)

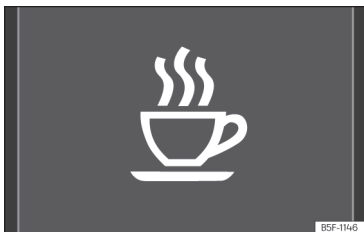


Fig. 76 On the instrument panel display: driver alert system symbol.

The Fatigue detection informs the driver when their driving behaviour shows signs of fatigue.

Function and operation

Fatigue detection determines the driving behaviour of the driver when starting a journey, making a calculation of tiredness. This is constantly compared with the current driving behaviour. If the system detects that the driver is tired, an audible warning is given with a sound and an optic warning is shown with a symbol and complementary message on the instrument panel display »» Fig. 76. The message on the instrument panel display is shown for approximately 5 seconds, and depending on the case, is repeated. The system stores the last message displayed.

The message on the instrument panel display can be switched off by pressing the **OK/RESET** button on the windscreen wiper lever or the button **OK** on the multi function steering wheel »» page 85.

The message can be recalled to the instrument panel display using the multifunction display »» page 73.

Conditions of operation

Driving behaviour is only calculated on speeds above about 65 km/h (40 mph) up to around 200 km/h (125 mph).

Switching on and off

The system can be switched on or off in the **Assistants** menu. A mark indicates that the adjustment has been activated.

System limitations

The Fatigue detection has certain limitations inherent to the system. The following conditions can limit the Fatigue detection or prevent it from functioning.

- At speeds below 65 km/h (40 mph)
- At speeds above 200 km/h (125 mph)
- When cornering
- On roads in poor condition
- In unfavourable weather conditions
- When a sporty driving style is employed

- In the event of a serious distraction to the driver

Fatigue detection will be restored when the vehicle is stopped for more than 15 minutes, when the ignition is switched off or when the driver has unbuckled their seat belt and opened the door.

In the event of slow driving during a long period of time (below 65 km/h, 40 mph) the system automatically re-establishes the tiredness calculation. When driving at a faster speed the driving behaviour will be recalculated.

⚠ WARNING

Do not let the comfort afforded by the Fatigue detection system tempt you into taking any risks when driving. Take regular breaks, sufficient in length when making long journeys.

- **The driver always assumes the responsibility of driving to their full capacity.**
- **Never drive if you are tired.**
- **The system does not detect the tiredness of the driver in all circumstances. Consult the information in the section »» page 77, System limitations.**
- **In some situations, the system may incorrectly interpret an intended driving manoeuvre as driver tiredness.**
- **No warning is given in the event of the effect called microsleep!**

»

- Please observe the indications on the instrument panel and act as is necessary.

Note

- Fatigue detection has been developed for driving on motorways and well paved roads only.
- If there is a fault in the system, have it checked by a specialised workshop.

Road signs detection system¹⁾

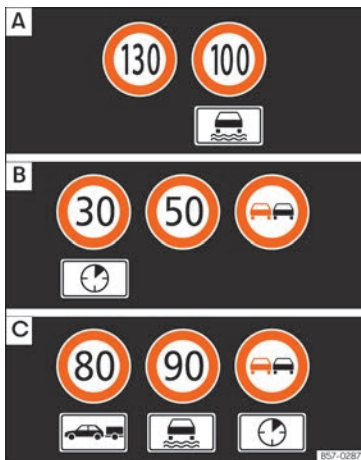


Fig. 77 On the instrument panel display: examples of speed limits or overtaking prohibitions with their respective additional signs.

The traffic sign detection system records the standard traffic signs in front of the vehicle with a camera located on the base of the interior mirror and provides information about speed limits and overtaking prohibitions.

Within its limitations, the system also displays additional signals, such as time-specific prohibitions, signs for vehicles towing trailers » **page 301** or limitations that only apply in the event of rain. Even on journeys without signs, the system may display any applicable speed limits.

Applicable countries

At the time of printing this instruction manual, the road signs detection system worked in the following countries:

Germany, Andorra, Austria, Belgium, Vatican City, Denmark, Spain, Finland, France, Ireland, Italy, Liechtenstein, Luxembourg, Monaco, Norway, Netherlands, Poland, Portugal, United Kingdom, Czech Republic, San Marino, Sweden, Switzerland.

Road sign detection system messages:

Error: Sign Assist

- System fault. Have the system checked by a specialised workshop.

Sign Assist: Clean the windscreen!

- The windscreen is dirty in the area of the camera. Clean the windscreen.

¹⁾ System available depending on the country.

Sign Assist: only partly available at the moment.

- The navigator does not transmit data. Connect the navigator and insert the navigation data media.
- **OR:** road sign detection is not supported in the country where the vehicle is currently driving.

Switching on and off

- Connect or disconnect the assist system in the **Settings** menu in the SEAT information system » page 74.
- **OR:** press the button for the driver assistance systems on the main beam lever » page 86.

Display of traffic signs

Speed limits or overtaking prohibitions together with the corresponding additional signs are shown on the instrument panel display. Depending on the navigation system installed in the vehicle, traffic signs will be shown as above and also in the navigation system's map display.

When the traffic sign detection system is connected, a camera located on the base of the interior rear-view mirror records the traffic signs in front of the vehicle. After checking and evaluating the information from the camera, the navigation system and the current vehicle data, up to three valid road signs are

displayed, » Fig. 77 [B] with their additional signs.

- **First:** The sign that is currently valid for the driver is shown in the left side of the screen. For example, a maximum speed limit of **130 km/h (100 mph)** » Fig. 77 [A].
- **Second:** A sign valid only in certain circumstances, e.g. **100 km/h (60 mph)** is shown second, together with the additional rain sign.
- **Additional sign:** If the windscreen wiper is working while you are driving, the signal with the additional rain sign will be shown first, on the left, as it is the one that is applicable at the time.
- **Third:** A sign valid only with restrictions, e.g. No overtaking at certain times, will be displayed in third place » Fig. 77 [C].

The permanent display on the instrument panel screen is shown as you pass the real traffic signs.

The signs for entering and leaving towns activate the display of the usual speed limits for that country on roads in populated areas and national highways, even if the speed is not limited by an actual traffic sign.

The end of a prohibition or limitation is not displayed.

If you exceed the speed limits shown, a warning will not appear. The system does not rec-

ognise residential street signs. The current legal provisions apply.

Trailer mode

Connect or disconnect the secondary display for speed limits and overtaking bans that apply to trailers (trailer mode) in the **Settings** menu in the SEAT information system » page 73.

Limited operation

The traffic sign detection system has certain limitations. The following cases may lead the system to operate with limitations or not at all:

- In the case of poor visibility, e.g. in snow, rain, fog or intense mist.
- In cases of dazzling, e.g. caused by head-on traffic or by the sun.
- When driving at high speeds.
- If the camera is covered or dirty.
- If the traffic signs are out of the camera's field of vision.
- If the traffic signs are partially or totally covered, e.g. by trees, snow, dirt or other vehicles.
- In the case of traffic signs that do not fulfil the regulations.
- In the case of damaged or bent traffic signs.

- In the case of variable messages on overhead or gantry signs (LED-based variable traffic signs or other lighting units).
- If the maps on the navigation system are not up-to-date.
- In the case of adhesives affixed to vehicles that depict traffic signs, e.g. speed limits on lorries.

WARNING

The technology in the traffic sign detection system cannot change the limits imposed by the laws of physics and only works within the system's limits. Do not let the extra convenience afforded by the traffic sign detection system tempt you into taking any risks when driving. The system is not a replacement for driver awareness.

- Adapt your speed and driving style to suit visibility, weather, road and traffic conditions.
- Poor visibility, darkness, snow, rain and fog may lead to the system failing to display traffic signs or not displaying them correctly.
- If the camera's field of vision is dirty, covered or damaged, system operation may be impaired.

WARNING

The driving recommendations and traffic indications shown on the traffic sign detec-

tion system may differ from the actual current traffic situation.

- The system may not detect or correctly show all the traffic signs.
- Traffic signs and traffic regulations have priority over the recommendations and displays provided by the system.

WARNING

If messages are ignored, the vehicle may stall in traffic and cause accidents and severe injuries.

- Never ignore the messages displayed.
- Stop the vehicle at the next opportunity and in a safe place.






Note

To avoid affecting the correct operation of the system, take the following points into consideration:

- Regularly clean the area of vision of the camera and keep it in a clean state, without snow or ice.
- Do not cover the field of vision of the camera.
- Always replace damaged or worn blades when required to avoid lines on the camera's field of vision.
- Check that the windscreen is not damaged in the area of the camera's field of vision.

- The use of outdated maps on the navigation system may cause the system to show traffic signs incorrectly.
- In the waypoints mode of the navigation system, the traffic sign detection system is only partly available.
- Failure to heed the control lamps and corresponding text messages when they light up may result in damage to the vehicle.

Time

- Press the  **Fig. 75**  to select the hour or minute display.
- To continue setting, press the  **Fig. 75**  button. Hold button down to scroll through the numbers quickly.
- Press the  button again to end the clock setting.

Revolution counter

The rev counter indicates the number of engine revolutions per minute.

Together with the gear-change indicator, the rev counter offers you the possibility of using the engine of your vehicle at a suitable speed.

The beginning of the red zone of the rev counter indicates the maximum speed in any gear after running-in and with the engine hot. However, it is advisable to change up a gear or move the selector lever to **D** (or lift your foot off the accelerator) before the needle reaches the red zone »» ❶.

We recommend that you avoid high revs and that you follow the recommendations on the gear-change indicator. Consult the additional information in »» page 253, **Selecting the optimal gear.**

❶ CAUTION

- To prevent damage to the engine, the rev counter needle should only remain in the red zone for a short period of time.
- When the engine is cold, avoid high revs and heavy acceleration and do not make the engine work hard.

🌿 For the sake of the environment

Changing up a gear early will help you to save fuel and minimise emissions and engine noise.

Fuel gauge



Fig. 78 On the instrument panel: fuel gauge.

Control lamps



It lights up.
Gauge position in the red mark
(arrow) »» Fig. 78

The fuel tank is almost empty »» ⚠️. The fuel tank reserve has been consumed »» page 357.
Refuel as soon as possible »» ❶.



It lights up

The fuel tank is not properly closed.
Stop the vehicle and close the tank flap correctly.

The display only works when the ignition is switched on.

The fuel range is displayed on the instrument panel.

You can consult the tank capacity of your vehicle in the »» page 357 section.

When the control lamp lights up ❶ the additional petrol powered heating and the additional heater are automatically switched off.

⚠️ WARNING

When driving with low fuel, the vehicle may stall in traffic and cause accidents and severe injuries.

- If the fuel tank level is too low, fuel could reach the engine irregularly, particularly when driving up or down slopes.
- The steering system and the driver assistance systems and brakes do not work when the engine is running irregularly or switches off due to lack of fuel or an irregular supply thereof.
- SEAT recommends always refuelling when the tank is approximately one quarter full, to prevent the vehicle from stopping due to a lack of fuel.

❶ CAUTION

Never run the fuel tank completely dry. An irregular fuel supply can cause misfiring and unburnt fuel could enter the exhaust system. The catalytic converter or the particulate filter may get damaged!

»

Note

The small arrow on the fuel gauge next to the fuel pump symbol points out towards the side of the vehicle with the fuel tank flap.

Engine coolant temperature indicator.

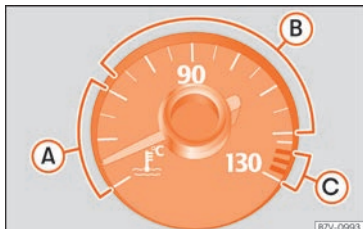



Fig. 79 Instrument panel: engine coolant temperature indicator.

- A Cool zone.** The engine has not reached operating temperature yet. Avoid high speeds and stressing the engine if it has not reached operating temperature.
- B Normal zone.** At high outside temperatures and when the engine is subject to

high forces, the needle may move considerably to the right. This is no cause for concern, provided the control lamp does not light up .

- C Warning area.** When the engine is working hard, especially at high outside temperatures, the needle may move into the warning area.


The coolant temperature gauge only works when the ignition is switched on.

Control and warning lamp




It lights up red


Engine coolant system faulty.

-  **Do not continue driving.** Seek specialist assistance.




It lights up red Indicator in the normal area 

Insufficient engine coolant level.



Check the engine coolant when the engine has cooled and, if it is low, refill with engine coolant  page 321.

Even if the coolant level is correct, there is a fault.



It lights up red Indicator in the warning zone 

Excessive engine coolant temperature.


-  **Stop the vehicle!** Stop the vehicle safely as soon as possible. Switch off the engine and wait for it to cool down and for the needle to return to the normal area. Check the engine coolant level  page 321.



Flashes red

Engine coolant system faulty.
Seek specialist assistance.

CAUTION

- To ensure a long useful life for the engine, avoid high revs, driving at high speed and making the engine work hard for approximately the first 15 minutes when the engine is cold. The phase until the engine is warm also depends on the outside temperature. If necessary, use the engine oil temperature as a guide  page 73.
- Additional lights and other accessories in front of the air inlet reduce the cooling effect of the coolant. At high outside temperatures and high engine loads, there is a risk of the engine overheating.
- The front spoiler also ensures proper distribution of the cooling air when the vehicle is moving. If the spoiler is damaged this can reduce the cooling effect, which could cause the engine to overheat. Seek specialist assistance.

Compass

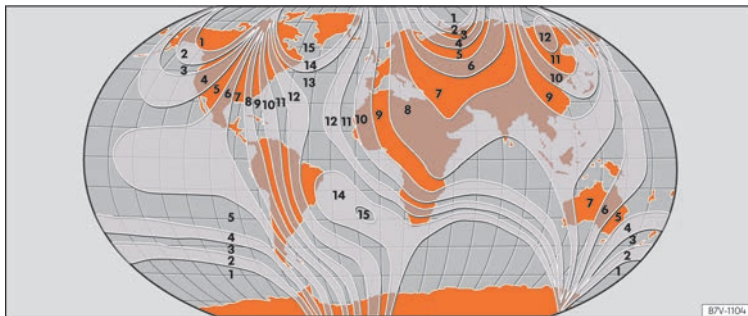


Fig. 80 Magnetic zones

The compass does not require calibration in vehicles for which the navigation system was mounted at the factory. The option **compass** disappears.

The compass in vehicles in which the navigation system was not mounted at the factory, is permanently and automatically calibrated. If electronic or metal accessories (mobile phone, television) are subsequently mounted in the vehicle, the compass should be recalibrated manually.

Adjusting the magnetic zone

- Switch the ignition on.
- Select the **Settings** menu followed by the option **Compass** and **Zone**.

- Select the magnetic zone corresponding to the position of the vehicle » Fig. 80.
- Adjust and confirm the magnetic zone (1-15).

Calibrating compass

To calibrate the compass you must be in one of the valid magnetic zones with sufficient space to be able to trace a circumference with the vehicle.

- Switch the ignition on.
- Select the **Settings** menu followed by the option **Compass** and **Calibrate**.
- Confirm the message **Turn through a full circle to calibrate the compass**

with key **OK/RESET** on the wiper lever or key **OK** on the multifunction steering wheel and then turn through a full circle at around 10 km/h (6 mph).

When the corresponding cardinal point is displayed, the calibration is complete.

Service intervals

The service interval indication is shown on the instrument panel display.

SEAT distinguishes between services *with* engine oil change (e.g. Oil change service) and services *without* engine oil change (e.g. Inspection).


»

In vehicles with **Services established by time or mileage**, the service intervals are already pre-defined.

In vehicles with **LongLife Service**, the intervals are determined individually. Thanks to technological progress, maintenance work has been greatly reduced. Because of the technology used by SEAT, with this service you only need to change the oil when the vehicle so requires. To calculate this variation (max. 2 years), the vehicle's conditions of use and individual driving styles are considered. The advance warning first appears 20 days before the date established for the corresponding service. The kilometres (miles) remaining until the next service are always rounded up to the nearest 100 km (miles) and the time is given in complete days. The current service message cannot be viewed until 500 km after the last service. Prior to this, only lines are visible on the display.

Inspection reminder


If a service or an inspection has to be carried out soon, a **service reminder** will be displayed when the ignition is switched on.

In *vehicles without text messages*, a spanner symbol  is displayed on the instrument panel and a figure given in **km**. The number of kilometres shown is the maximum number that may be driven until the next service. After a few seconds, the display mode changes. A clock symbol appears and the number of

days until the next service appointment is due.



In *vehicles with text messages*, **Service in --- km (miles) or --- days** is displayed on the instrument panel.

Service due

After **the service date**, an audible warning is given when the ignition is switched on and the spanner displayed on the screen  flashes for a few seconds. In *vehicles with text messages*, the following will be displayed on the instrument panel: **Service now**.

Consult a service notification

With the ignition switched on, the engine off and the vehicle at a standstill, the current **service notification** can be read:

- Press the  button on the instrument panel several times until the spanner symbol  is displayed.
- **OR:** select the **Settings > Service** menu.
- Select the **Info** option.

When the **service date has past**, a minus sign is displayed in front of the number of kilometres or days. In *vehicles with text messages* the following is displayed: **Service --- km (miles) or --- days ago**.



Resetting service interval display

If the service was not carried out by a SEAT dealership, the display can be reset as follows:

Vehicles with text messages

- Select the menu **Settings> Service**.
- Select the **Reset** option.
- Confirm with key **OK** on the multifunction steering wheel when required by the system.

Vehicles without text messages

- Switch the ignition off.
- Press and hold the **0.0/SET**  **Fig. 75 7** button.
- Switch ignition back on.
- Release key **0.0/SET** and, within the next 20 seconds, press key  **Fig. 75 1**

Do not restart the indicator between the service intervals, otherwise the information displayed will be incorrect.

If the oil change service is reset manually, the service interval display changes to a fixed service interval, also in vehicles with **Flexible oil change service**.

Note

- **The service message disappears after a few seconds, when the engine is started or when **OK/RESET** button is pressed on the wiper**

lever, or the **OK** button on the multifunction steering wheel.

- In vehicles with the LongLife system in which the battery has been disconnected for a long period of time, it is not possible to calculate the date of the next service.

Therefore the service interval display may not be correct. In this case, bear in mind the maximum service intervals permitted »» page 337.

- If you reset the display manually, the next service interval will be indicated as in vehicles with fixed service intervals. For this reason we recommend that the service interval display be reset by a SEAT authorised Dealer.

Using the instrument panel

Introduction

With the ignition switched on, it is possible to read the different functions of the display by scrolling through the menus.

In vehicles with multifunction steering wheel, the multifunction display can only be operated with the steering wheel buttons.

Some menu options can only be read when the vehicle is at a standstill.

⚠ WARNING

Distracting the driver in any way can lead to an accident and cause injuries.

- Never use the menus on the instrument panel display while the vehicle is in motion.

i Note

After loading or changing the 12-volt battery, check the system settings. If the power supply is interrupted, the system settings might be incorrect or deleted.

Operation using the multifunction steering wheel

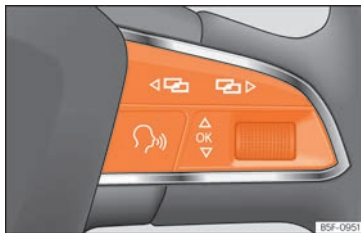


Fig. 81 Multifunction steering wheel: buttons for using the instrument panel menus.

As long as a priority 1 »» page 76 warning is active, it will not be possible to access any menu. Some warnings can be confirmed and

hidden with the button **OK** of the multifunction steering wheel »» Fig. 81.

Select a menu or an informative display

- Switch the ignition on.
- If a message or vehicle symbol is displayed, press the button **OK** »» Fig. 81; if necessary, several times.
- Use the **<** or **>** »» Fig. 81 to switch between menus.
- To open the menu or the information displayed, press the button **OK** »» Fig. 81 or wait a few seconds until the menu or the information display opens automatically.

Changing menu settings

- In the menu displayed, turn the right thumb-wheel of the multifunction steering wheel »» Fig. 81 until the desired option of the menu is highlighted. The option appears framed.
- Press the button **OK** »» Fig. 81 to make the required modifications. A mark indicates that the system or function is activated.

Back to menu selection

Press the **<** or **>** »» Fig. 81 button.

Operation with the wiper lever

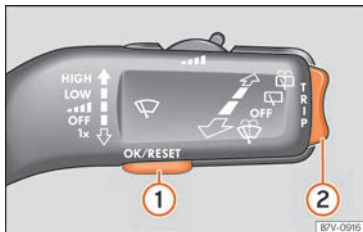


Fig. 82 Wiper lever: buttons for using the instrument panel menus.

As long as a priority 1 »» page 76 warning is active, it will not be possible to access any menu. Some warnings can be confirmed and hidden with the button »» **Fig. 82 1**.

Select a menu or an informative display

- Switch the ignition on.
- If a message or vehicle symbol is displayed, press button **1**; if necessary, several times.
- To display the menus »» page 73 or to return to the selection of menus from a menu or from an informative display, hold down the rocker button **2**.
- To change from one menu to another, press the upper or lower part of the rocker switch.
- To open the menu or the informative display shown, press button **1** or wait a few seconds

until the menu or the informative display opens automatically.

Changing menu settings

- In the menu displayed, press the upper or lower part of the rocker switch **2** until the required menu option is checked. The option appears framed.
- Press button **1** to make the required modifications. A mark indicates that the system or function is activated.

Back to menu selection

Select **Back** on the corresponding menu to exit.

i Note

If when switching on the ignition warnings are shown about existing faults, it might not be possible to change the settings or show the information as described. In this case, go to a specialised workshop and request a repair.

Button for the driver assistance systems

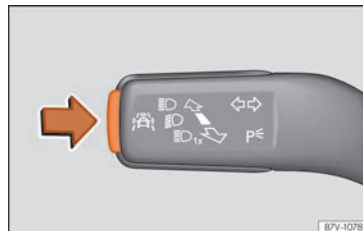


Fig. 83 On the turn signal and main beam headlight lever: button for driver assistance systems.


With the turn signal and main beam headlight lever button, you can activate or deactivate the driver assistance systems displayed in the **Assistance systems** menu.

Activate or deactivate a driver assistance system

- Briefly press the »» **Fig. 83** button to open the **Assistants** menu.
- Select the driver assistance system and activate or deactivate it »» page 85. A mark indicates that driver assistance system is switched on.
- Afterwards, mark or confirm the selection with button **OK/RESET** on the windscreen wiper lever or button **OK** on the multifunction steering wheel.

Control lamps

Control and warning lamps





The control and warning lamps are indicators of warnings **»** , faults or certain functions. Some control and warning lamps come on when the ignition is switched on, and switch off when the engine starts running, or while driving.






Depending on the model, additional text messages may be viewed on the instrument panel display. These may be purely informative or they may be advising of the need for action **»** [page 70, Instrument panel](#).

Depending upon the equipment fitted in the vehicle, instead of a warning lamp, sometimes a symbol may be displayed on the instrument panel.










When certain control and warning lamps are lit, an audible warning is also heard.










Red warning lamps

	Parking brake engaged OR anomaly in the brake system » page 282 .
	Fault in the steering system » page 254 .
	Driver or passenger has not fastened seat belt » page 15 .
	Engine cooling fluid » page 82 .





	Engine oil pressure » page 319 .
	Alternator abnormality » page 326 .
	Press the foot brake » page 282 , » page 248 , » page 269 .
	Open or not properly closed door » page 104 .
	Open or not properly closed rear lid » page 108 .

Yellow warning lamps

	Front brake pads worn » page 282 .
	Fault in ESC or disconnection caused by the system; OR ESC or ASR in operation » page 287 .
	ASR manually deactivated » page 287 .
	Fault in the ABS » page 287 .
	Electronic parking brake faulty » page 282 .
	Rear fog light switched on » page 117 .
	Fault in the emission control system » page 314 .
EPC	Fault in the petrol engine management » page 314 .
	Particulate filter blocked » page 314 .
	Fault in the steering system » page 254 .

	Tyre pressure monitor system » page 334 .
	Fuel tank almost empty » page 81 .
	Fault in airbag system and seat belt tensioners » page 24 .
OFF 	Front passenger front airbag disabled » page 24 .
	Fault in the lighting of the vehicle » page 117 .
	Low engine oil level » page 319 .
	Fuel tank flap is open » page 81 .
	Lane assist warning (Lane Assist) » page 274 .
	Windscreen cleaning fluid too low » page 324 .

Green indicator lamps

	Turn lights or emergency lights on » page 117 .
	Press the foot brake » page 248 .
	Speed regulator » page 262 ; OR Adaptive Cruise Control (ACC) » page 269 .
	Lane assist active (Lane Assist) warning » page 274 .

»

Blue indicator lamps



Main beam on or flasher on »» page 117.

Other warning lamps

Main beam assist (Light Assist)
»» page 117.

Service interval display »» page 83.

Mobile phone connected through Blue-
tooth® »» page 226.

Mobile phone charge level »» page 226.



Risk of freezing »» page 72.



Start-Stop system activated »» page 245.

Start-Stop system unavailable
»» page 245.**⚠ WARNING**

If the warning lamps and messages are ignored, faults may occur in the vehicle, it may stall in traffic, or accidents and serious injuries may occur.

- Never ignore the warning lamps or text messages.
- Stop the vehicle safely as soon as possible.
- A faulty vehicle represents a risk of accident for the driver and for other road users.

If necessary, switch on the hazard warning lamps and put out the warning triangle to advise other drivers.

- Before opening the bonnet, switch off the engine and allow it to cool.
- In any vehicle, the engine compartment is a hazardous area and could cause severe injuries »» page 315.

Multifunction steering wheel

Operation of the audio, telephone and navigation system with voice control

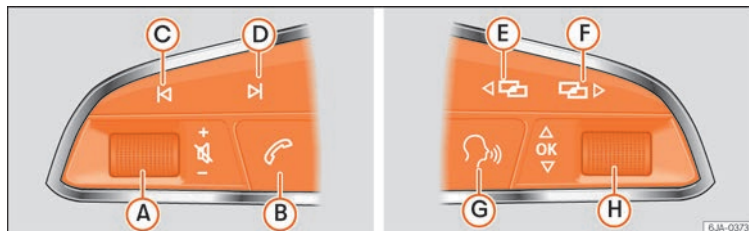


Fig. 84 Controls on the steering wheel.





The steering wheel includes a multifunction module from where it is possible to control

the audio, telephone and radio/navigation functions without needing to distract the driver.

Button	Radio	Media (except AUX)	AUX	Telephone	Navigation
A Turn	Turn volume up/down.	Turn volume up/down.	Turn volume up/down.	Turn volume up/down.	Turn announcement volume up/down.
A Press	Mute volume.	Mute volume.	Mute volume.	Mute incoming call.	Mute voice navigation
B ^{a)}	– Incoming call: pick up [short press], reject [long press]. – Active call: hang up active call [short press]. – No active / incoming call: open phone menu [short press], re-dial the last active call [long press]. This function can be used from any mode (audio, media, navigation, assistants, vehicle status, driving data).				
C / D	Search for the previous/next station ^{b)} .	Short press: Switch to the previous/next track. Long press: Fast rewind/forward ^{c)} .	No function	– No active call: Radio/Media functionality (except AUX) – Active call: no function	No function for the other modes (navigation, assistants, vehicle status, travel data).

»

Operation

Button	Radio	Media (except AUX)	AUX	Telephone	Navigation
 ^{a1}	Change menu on instrument panel. This function can be used from any mode (audio, media, navigation, vehicle status, travel data).				
	Activate/deactivate voice control. ^{d1} This function can be used from any mode, except in the case of an active call.				
 <i>Turn</i>	Next/previous pre-tuning (only if the instrument panel is in the audio menu).	Next/previous pre-tuning (only if the instrument panel is in the audio menu).	Operates the instrument panel menu, depending on the one that is displayed.	Operates the instrument panel menu, depending on the one that is displayed.	Operates the instrument panel menu, depending on the one that is displayed.
 <i>Press</i>	Acts on the instrument panel or confirms the instrument panel menu option depending on the menu option.				

^{a1} According to the vehicle's equipment package.

^{b1} This action can be performed when you are listening to the radio; there is no need to be in audio-radio mode.

^{c1} These actions can be performed when you are listening to media; there is no need to be in audio-radio mode.

^{d1} This function can be used from any mode (audio, media, navigation, vehicle status, travel data).

Three button unit in the roof

Three button module

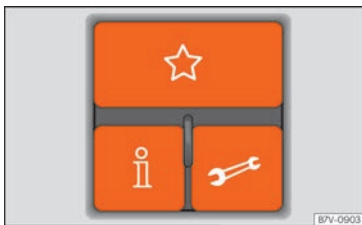


Fig. 85 Three button module in the roof: telephone management system controls.



Press it briefly: to accept or end a call.
Keep it pressed down: to reject a call.

Short press: to start or stop the voice control function, for example, to make a call.^{a)}



Hold down for over 2 seconds: to obtain information about the SEAT brand and selected additional services related to traffic and travel.




Hold down for over 2 seconds: to obtain help from the network of SEAT dealers in the event of a breakdown.

^{a)} Not operational if a navigation system with voice control is fitted.

¹⁾ Depending upon country.

Information and assistance calls

Communication with the SEAT Customer Care Service is established using the **i** and  buttons of the three-button unit¹⁾. The system will automatically connect you with the Assistance Centre of the relevant country. You will only be able to make calls if your mobile is turned on and connected to the pre-installed Bluetooth.


Information call

The **Information call i** button offers information on the SEAT brand and selected additional services related to traffic and your travel.

To establish communication, press the **i** button for more than 2 seconds.




In countries where there is no information telephone number, an information call is made by pressing the **i** button.

Assistance call

The **assistance call ** button gives immediate help in case of a breakdown. To this end, the SEAT dealer network, with its mobile assistance vehicles, is at your disposal.


To establish communication, press the  button for more than 2 seconds.

Note

- Calls made with the **i** and  buttons take priority over normal calls. If the **i** or  button is pressed during a normal telephone call, this call will be cut off and an information call or assistance call will be made.
- If the assistance call button  is pressed during an information call, the information call will be interrupted to make the assistance call (and vice versa).
- Mobile phone coverage must be available to place a call to the information and assistance services. This service might not be available in some countries.

Activate and deactivate voice control

Switching on the speech control system


- Press the  button on the multi-function steering wheel.
- Wait for the acoustic signal.
- Give the command.
- Follow the dialogue instructions (extended dialogue).



Ending voice control

- Press twice or hold down the  button on the multifunction steering wheel.

Interrupting the instructions

- During the instructions, press the  button on the multi-function steering wheel.
- You will be able to give a command immediately afterwards.

Opening and closing

Set of vehicle keys

Vehicle key

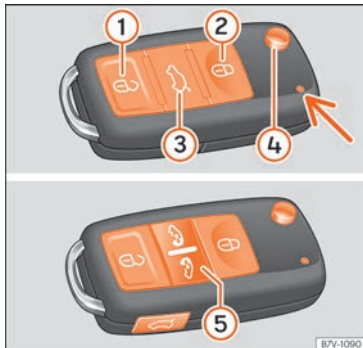


Fig. 86 Assignment of buttons on the remote control key.

Key to the » **Fig. 86**

- ① Unlock the vehicle
- ② Lock the vehicle
- ③ Unlock only the rear lid. Press the button until all the turn signals on the vehicle flash briefly. You have 2 minutes to open the rear lid. Once this time has passed, it

will lock again. In addition, the lamp on the key flashes.

- ④ Folding the key shaft in and out
- ⑤ Open the electric sliding door.

With the vehicle key the vehicle may be locked or unlocked remotely » **page 95**.

The vehicle key includes an emitter and battery. The receiver is in the interior of the vehicle. The range of the vehicle key with remote control and new battery is several metres around the vehicle.

If it is not possible to open or close the vehicle using the remote control key, this should be re-synchronised » **page 95** or the battery changed » **page 94**.

Different keys belonging to the vehicle may be used.

Control lamp on the vehicle key

When a button on the vehicle key is pressed, the control lamp flashes » **Fig. 86** (arrow) once briefly, but if the button is held down for a longer period the control lamp flashes several times, such as in convenience opening.

If the vehicle key control lamp does not light up when the button is pressed, replace the key's battery » **page 94**.

Spare key

To obtain a spare key and other vehicle keys, the vehicle ID number is required.

Each new key contains a microchip which must be coded with the data from the vehicle electronic immobiliser. A vehicle key will not work if it does not contain a microchip or the microchip has not been encoded. This is also true for keys which are specially cut for the vehicle.

The vehicle keys or new spare keys can be obtained from a SEAT Official Service, a specialised workshop or an approved key service qualified to create this kind of key.

New keys or spare keys must be synchronised before use » **page 95**.

⚠ WARNING

- **Never leave children or disabled persons in the vehicle. In case of emergency, they may not be able to leave the vehicle or manage on their own.**
- **An uncontrolled use of the key could start the engine or activate any electric equipment (e.g. electric windows), causing risk of accident. The doors can be locked using the remote control key. This could become an obstacle for assistance in an emergency situation.**
- **Never forget the keys inside the vehicle. An unauthorised use of your vehicle could result in injury, damage or theft. Therefore**

»

always take the key with you when you leave the vehicle.

- Never remove the key from the ignition if the vehicle is in motion. Otherwise, the steering could suddenly block and it would be impossible to steer the vehicle.

ⓘ CAUTION

All of the vehicle keys contain electronic components. Protect them from damage, impacts and humidity.

ⓘ Note

- Only use the key button when you require the corresponding function. Pushing the button unnecessarily could accidentally unlock the vehicle or trigger the alarm. It is also possible even when you are outside the radius of action.
- Key operation can be greatly influenced by overlapping radio signals close to the vehicle working in the same range of frequencies, for example, radio transmitters or mobile telephones.
- Obstacles between the remote control and the vehicle, bad weather conditions and discharged batteries can considerably reduce the range of the remote control.
- If the buttons of the vehicle key are pressed or one of the central locking buttons » page 97 is pressed repeatedly in short succession, the central locking brief-

ly disconnects as protection against overloading. The vehicle is then unlocked. Lock it if necessary.

- Spare remote control keys are available at your Technical Service, where they must be matched to the locking system.
- Up to five remote control keys can be used.

To change the battery

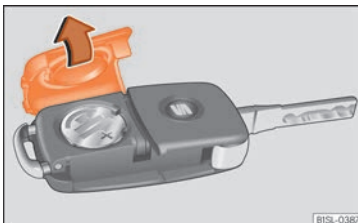


Fig. 87 Vehicle key: battery compartment cover.

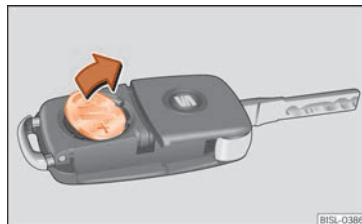


Fig. 88 Vehicle key: remove the battery.

SEAT recommends you ask a specialised workshop to replace the battery.

The battery is located to the rear of the vehicle key, under a cover.

Changing the battery

- Unfold the vehicle key blade » page 93.
- Remove the cover from the back of the vehicle key » Fig. 87 in the direction of the arrow » ⓘ.
- Extract the battery from the compartment using a suitable thin object » Fig. 88.
- Place the new battery in the compartment as shown » Fig. 88, pressing in the opposite direction to that shown by the arrow » ⓘ.
- Fit the cover as shown » Fig. 87, pressing it onto the vehicle key casing in the opposite direction to that shown by the arrow until it clicks into place.

⚠ WARNING

Swallowing a battery with a 20 mm diameter or any other button battery can cause serious and even fatal injuries within a very short time.

- Keep the vehicle key and key fobs with batteries out of reach of children.
- If you suspect that someone may have swallowed a battery, seek immediate medical attention.


ⓘ CAUTION

- If the battery is not changed correctly, the vehicle key may be damaged.
- Use of unsuitable batteries may damage the vehicle key. For this reason, always replace the dead battery with another of the same voltage, size and specifications.
- When fitting the battery, check that the polarity is correct.


♻ For the sake of the environment

Please dispose of your used batteries correctly and with respect for the environment.

Synchronize the vehicle key

If the  button is pressed frequently outside of the vehicle range, it is possible that the ve-

hicle can no longer be locked or unlocked using the key. In this case, the key must be re-synchronised as described below:

- Unfold the vehicle key blade **»» page 93**.
- If necessary, remove the cover from the driver door lever **»» page 104**.
- Press the  button on the vehicle key. For this, it must remain with the vehicle.
- Open the vehicle within one minute using the key blade. The key has been synchronised.
- If necessary, fit the cap.

Central locking**Introduction**

Central locking functions correctly when all the doors and the rear lid are correctly shut. If the driver door is open, the vehicle *cannot* be locked with the key.

If the vehicle has the Keyless Access locking and ignition system, it may only be locked with the ignition off and the driver's door closed.

⚠ WARNING

The incorrect use of the central locking system may cause serious injuries.

- The central locking system will lock all doors. A vehicle locked from the inside can prevent any non-authorised individual from opening the doors and accessing the vehicle. Nevertheless, in case of emergency or accident, locked doors will complicate access to the vehicle interior to help the passengers.
- Never leave children or disabled people alone in the vehicle. The central locking button can be used to lock all the doors from within. Therefore, passengers will be locked inside the vehicle. Individuals locked in the vehicle can be exposed to very high or very low temperatures.
- Depending on the time of the year, temperatures inside a locked and closed vehicle can be extremely high or extremely low resulting in serious injuries and illness or even death, particularly for young children.
- Never leave individuals locked in a closed and locked vehicle. In case of emergency, they may not be able to exit the vehicle by themselves or get help.

Description

Central locking allows all doors, the rear lid and the tank flap to be unlocked centrally:

- From outside, using the vehicle key **»» page 97**.



- From outside with the Keyless Access »»» **page 98** system,

- From inside, by pushing the central locking button »»» **page 97**.

Various functions are available to improve the vehicle safety:

- Security system "Safe" »»» **page 101**
- Self-locking system to prevent involuntary unlocking
- Selective unlocking system
- Automatic speed dependent locking and unlocking system (Auto Lock)
- Emergency unlocking system

The **Settings > Comfort** menu can be used to connect or disconnect special central locking functions »»» **page 73**, or this can be done at a specialised workshop.

Self-locking system to prevent involuntary unlocking

It is an anti-theft system and prevents the unintentional unlocking of the vehicle. If the vehicle is unlocked and none of the doors (including the boot) are opened within 30 seconds, it re-locks automatically.

Automatic locking (Auto Lock)


The Auto Lock function locks the doors and the rear lid when the vehicle exceeds a speed of about 15 km/h (9 mph).

The vehicle is unlocked again when the ignition key is removed. Alternatively, the vehicle can also be unlocked via the central locking switch or by pulling one of the inside door handles.

In the event of an accident in which the air-bags inflate, the doors will be automatically unlocked to facilitate access and assistance.

Depending on the amount of damage, it can be locked following an accident in the following ways:

With the central locking button

- Switch the ignition off.
- Open a vehicle door once and close it again.
- Press the central locking button 

With the vehicle key

- Switch the ignition off.
- **OR:** remove the key from the ignition switch.
- Open a vehicle door once.
- Use the key to lock the vehicle.

Automatic unlocking (Auto Unlock)

When the key is removed from the ignition slot, here the vehicle unlocks all doors and the boot automatically »»» **page 73**.

Turn signals

The turn signals will flash twice when the vehicle is unlocked and once when the vehicle is locked.

If it does not flash, this indicates that one of the doors, the rear lid or the bonnet is not closed correctly.

Accidental lock-out

The central locking system prevents you from being locked out of the vehicle in the following situations:

- If the driver door is open, the vehicle cannot be locked with the central locking switch »»» **page 97**.

Lock the vehicle with the remote control key, when all the doors and the rear lid have been closed. This prevents the accidental locking of the vehicle.

Note





- **Never leave any valuable items in the vehicle unattended. Even a locked vehicle is not a safe.**
- **If the LED on the driver door sill lights up for about 30 seconds when the vehicle is locked, the central locking system or anti-theft alarm is not working properly. You should have the fault repaired at a SEAT Official Service or specialised workshop.**


- Vehicle interior monitoring by the anti-theft alarm system will only function as intended if the windows and sunroof are closed.


Unlock and lock from the outside



Fig. 89 Remote control key: buttons.

- Lock: press the  **Fig. 89** button.
- Locking the vehicle without the "Safe" security system: push the  button again and hold for 2 seconds.
- Unlock: press the  button.
- Unlocking the rear lid: hold down the  button for at least 1 second.


Warning: depending on the central locking function selected in the **Comfort** submenu, you may have to push the  button twice to unlock all doors and the rear lid **»»» page 73**.

The vehicle will be locked again automatically if you do not open one of the doors or the rear lid within 30 seconds after unlocking the car. This function prevents the vehicle from remaining unlocked if the unlocking button is pressed by mistake. This does not apply if you press the  button for at least one second.

Convenience open/close function

- See **»»» page 113**, Convenience open/close function.
- See **»»» page 116**, Convenience function to open or close the sunroof.

WARNING

Observe the safety warnings **»»»  in Locking system "Safe" on page 101.**

Note

Do not use the remote control key until the vehicle is visible.

Unlocking and locking from the inside



Fig. 90 Driver's door: central locking switch.

- Lock: press the  **»»» Fig. 90** button.
- Unlock: press the  **»»» Fig. 90** button.


Please note the following when using the central locking switch **»»» Fig. 90** to lock your vehicle:

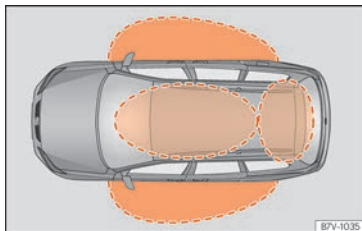
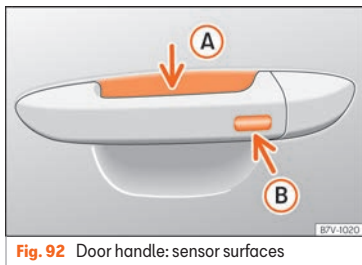
- It is not possible to open the doors or the rear lid from the *outside* (for safety reasons, e.g. when stopped at traffic lights).
- The central locking lamp **»»» Fig. 90** lights up when all the doors are closed and locked.
- You can open the doors individually from the inside by pulling the inside door handle.
- In the event of an accident in which the airbags inflate, doors locked from the inside will be automatically unlocked to facilitate access and assistance. **»»**

⚠ WARNING

- The central locking switch also works with the ignition switched off, except when the “safe” system is activated.
- The central locking switch does not operate if the vehicle is locked from the outside and the security system is switched on.
- Locked doors could delay assistance in an emergency. Do not leave anyone, especially children, in the vehicle.


i Note

Your vehicle will lock automatically when it reaches a speed of about 15 km/h (9 mph) (Auto Lock) » page 95. You can unlock the vehicle again using the  button on the central locking switch.

Unlock and lock the vehicle with Keyless Access**Fig. 91** Keyless Access: proximity zones.**Fig. 92** Door handle: sensor surfaces» **Fig. 92**

- A** Unlocking sensor surface on the inside of the door handle.
- B** Locking sensor surface on the outside of the door handle.

Depending on the equipment, the vehicle may have the Keyless Access system.

Keyless Access is a key-free locking and ignition system to unlock and lock the vehicle without actively using its key. To do this, all that is required is to have a valid vehicle key in the detection area where you are attempting to access the vehicle » **Fig. 91** and to touch one of the sensor surfaces on the door handles » **Fig. 92** » .

The vehicle can be unlocked and locked via the front doors only. When doing so, the remote control key must be no further than approx. 1.5 m away from the door handle.

It does not matter where you carry the key, e.g. in your jacket pocket.

Once the doors have been locked, they cannot be opened again immediately. This will enable you to check that the doors are properly closed.

If you wish you may unlock *only* the corresponding door or the entire vehicle. The necessary adjustments can be made in vehicles with a driver information system » **page 73**.

General information

If a valid key is located in the proximity of the car » **Fig. 91**, the Keyless Access lock and ignition system gives the key entry as soon as

one of the sensor surfaces on the door handles is touched or the push button on the boot hatch is operated.

The following features are then available without having to use the vehicle key actively:

- **Keyless-Entry:** unlocking of the vehicle with the handles on the four doors or the button located on the rear lid.
- **Keyless-Exit:** locking of the vehicle with one of the four door handles.
- **Easy Open:** opening the rear lid moving one foot below the rear bumper » page 111.
- **Press & Drive:** keyless starting of the engine with the starter button » page 241.

The central locking and locking systems operate in the same way as a *normal* locking and unlocking system. Only the controls change.

Unlocking the vehicle is confirmed with a *double* flash of the indicator lights; locking by a *single* flash.

The vehicle will lock again after a few seconds if you unlock the vehicle but fail to open any door or boot hatch.

Unlocking and opening the doors (Keyless-Entry)

- Grip the door handle. When you do this, you touch the sensor surface » Fig. 92 **A** (arrow) on the handle and the vehicle unlocks.

- Open the door.

In vehicles without the "Safe" security system: closing and locking the doors (Keyless-Exit)

- Switch the ignition off.
- Close the driver's door.
- Touch (once) the sensor surface » Fig. 92 **B** (arrow) on the door handle. The door that is used must be closed.

In vehicles with the "Safe" security system: closing and locking the doors (Keyless-Exit)

- Switch the ignition off.
- Close the driver's door.
- Touch (once) the sensor surface » Fig. 92 **B** (arrow) on the door handle. The vehicle locks with the "Safe" security system » page 104. The door that is used must be closed.
- Touch (twice) the sensor surface » Fig. 92 **B** (arrow) on the door handle to lock the vehicle without the "Safe" security system » page 104.


Unlocking and locking the boot hatch

When the vehicle is locked, the rear lid automatically unlocks on opening if there is a valid vehicle key in the proximity » Fig. 91.

Open or close the rear lid *normally*.

After closing, the hatch locks automatically. If the complete vehicle is unlocked, the rear lid will **not** lock automatically after closing it.

What happens when locking the vehicle with a second key


If there is a vehicle key inside the vehicle and it is locked from the outside with a second vehicle key, the key inside the vehicle is blocked for engine ignition » page 241. In order to enable engine ignition, press the  button on the key inside the vehicle.

Automatically disabling sensors

If the vehicle is not locked or unlocked for a long period of time, the proximity sensors on the passenger doors are automatically disabled.



If one of the sensor surfaces on the door handles is often activated in an unusual manner with the vehicle locked (e.g. by the branches of a bush rubbing against it), all proximity sensors are disabled for a certain period of time.

Sensors will again be enabled:

- After a time.
- **OR:** if the vehicle is unlocked with the button  on the key.
- **OR:** if the boot is opened.
- **OR:** if the vehicle is unlocked manually with the key.


Keyless Access temporary disconnection function

You can deactivate the vehicle's Keyless Access unlocking for one locking and unlocking cycle.

- Move the gear lever to position **P** (if the vehicle has automatic gearbox), since otherwise the vehicle cannot be locked.
- Close the door.
- Push the central locking button  on the remote control and touch the locking sensor surface of the driver door handle » » Fig. 92  within the following 5 seconds. Do not grasp the door handle; otherwise the vehicle will not unlock. Deactivation is also possible if the vehicle is locked through the driver's door lock.
- To check that the function has been deactivated, wait at least 10 seconds, grip and pull on the door handle. The door should not open.


The next time the door can only be unlocked via the remote control or the lock cylinder. The next time the door is locked/unlocked, Keyless Access will be active again.

Convenience functions

To close all the electric windows and the panoramic sliding sunroof using the **comfort function**, keep a finger for a few seconds on the locking sensor surface » » Fig. 92  (arrow) of the door handle until the windows and roof have closed.

The way that the doors open when the door handle sensor surface is touched will depend on the settings activated in the **Settings - Comfort** » » page 73 menu.

CAUTION

The sensor surfaces on the door handles could engage if hit with a water jet or high pressure steam if there is a valid vehicle key in the proximity. If at least one of the electric windows is open and the sensor surface » » Fig. 92  (arrow) on one of the handles is activated continuously, all windows will close.

Note

- If the vehicle battery has little or no charge, or the vehicle key battery is almost or entirely out of charge, you will probably not be able to lock or unlock the vehicle with the Keyless Access system. The vehicle can be unlocked or locked manually » » page 104.

- To control the proper locking of the vehicle, the release function is disabled for approx. 2 seconds.
- If the message **Keyless access system fault** is displayed on the screen of the dash panel, abnormalities may occur in the operation of the Keyless Access system. Contact a specialised workshop. SEAT recommends visiting a SEAT dealership for this.
- If there is no valid key inside the vehicle or the system fails to detect one, a warning will display on the dash panel screen. This could happen if any other radio frequency signal interferes with the key signal (e.g. from a mobile device accessory) or if the key is covered by another object (e.g. an aluminium case).
- If the sensors are very dirty, e.g. have a layer of salt, the correct functioning of the sensors on the door handles may be affected. In this case, clean the vehicle.
- If the vehicle is equipped with an automatic gearbox, it may only be locked in the gear stick is in position **P**.
- To improve the safety of your vehicle, the remote control of the system is equipped with a position sensor. If this remote control does not detect movement for a certain length of time, the system will conclude


that the vehicle cannot be opened (e.g. on a night table) so it will be disabled.

Locking system “Safe”¹⁾


When the vehicle is locked, the “Safe” security system puts the door handles out of operation and makes it difficult for unauthorized people to enter. The doors cannot be opened from inside »» » ⚠.

Depending on the vehicle, when switching the ignition off, a warning may be displayed on the dash panel screen stating that the “Safe” security system is activated (SAFE Lock or SAFELock).

Lock the vehicle and activate the “Safe” security system.

- Press the locking button  once on the vehicle key.

Lock the vehicle without activating the “Safe” system.

- Press the locking  button on the vehicle key twice.
- *On vehicles with the Keyless Access locking and ignition system:* touch the sensor surface on the outside part of the door handle twice.

When the “Safe” security system is disabled, the following needs to be taken into account:

- The vehicle can be opened and unlocked from the inside using an inside door handle.
- The anti-theft alarm is activated.
- The vehicle interior monitoring system and the anti-tow system are disabled.

WARNING

Do not leave anyone (especially children) in the vehicle if it is locked from the outside and the “Safe” security system is activated, as the doors and windows cannot then be opened from the inside. Locked doors could delay assistance in an emergency.

Anti-theft alarm system

Description

The anti-theft alarm makes it more difficult to break into the vehicle or steal it. The system will initiate acoustic and optical warning signals when your vehicle is tried to be forced.

The anti-theft alarm is automatically turned on when the vehicle is locked with the key. The system is immediately activated and the

turn signal light located on the driver door will flash along with the turn signals, indicating that the alarm and the locking security system (double lock) have been turned on.

If any of the doors or the bonnet are open, they will not be included in the protection zones of the vehicle when the alarm is connected. If the door or the bonnet are subsequently closed, they will be automatically included in the protection areas of the vehicle and the turn signals will flash accordingly when the doors close.

- The turn signal light will flash twice on opening and deactivating the alarm.
- The turn signal light will flash once on closing and activating the alarm.

When does the system trigger an alarm?

The anti-theft alarm siren will be triggered for about 30 seconds alongside a sound and optical (flashing) warning signals and will be repeated about ten times when the vehicle is locked and the following unauthorised actions are attempted:


- Opening a door that is mechanically unlocked using the vehicle key without switching on the ignition in the next 15 seconds (in certain markets, such as the Netherlands, there is »

¹⁾ Available depending on market and version.

no 15 second waiting time and the alarm is activated immediately on opening the door).

- A door is opened.
- Opening the bonnet.
- The rear lid is opened.
- When the ignition is switched on with a non-authorised key.
- Undue manipulation of the alarm.
- Disconnection of the vehicle battery.
- Movement inside the vehicle (in vehicles with interior monitoring »» page 102).
- When the vehicle is towed (in vehicles with anti-tow system »» page 102).
- When the vehicle is raised (in vehicles with anti-tow system »» page 102).
- When the vehicle is transported on a ferry or by rail (vehicles with an anti-tow system or vehicle interior monitoring »» page 102).
- When a trailer connected to the anti-theft alarm system is disconnected.

How to turn OFF the alarm

- Unlock the vehicle with the unlock button  of the key.
- **OR:** turn the ignition on with a valid key.


If the driver's door is unlocked mechanically using the key, the key must be inserted into the ignition, and the ignition must be turned on within 15 seconds of opening the door.

Otherwise, the alarm will trigger for 30 sec. and the ignition will be blocked.

CAUTION

If the anti-theft security system is switched off, the vehicle interior monitoring and the tow-away protection are automatically disconnected.

Note

- After 28 days, the indicator light will be switched off to prevent the battery from exhausting if the vehicle has been left parked for a long period of time. The alarm system remains activated.
- If, after the audible warning goes off, another monitored area is accessed (e.g. the rear lid is opened after a door has been opened), the alarm is triggered again.
- The anti-theft alarm is not activated when the vehicle is locked from within using the central locking button .
- If the driver door is unlocked mechanically with the key, only the driver door is unlocked, the rest of the doors remain locked. Only when the ignition has been turned on will the other doors be available - but not unlocked - and the central locking button will be activated.
- If the vehicle battery is run down or flat then the anti-theft alarm will not operate correctly.

- Vehicle monitoring remains active even if the battery is disconnected or not working for any reason.
- The alarm is triggered immediately if one of the battery cables is disconnected while the alarm system is active.

Interior monitoring and the anti-tow system

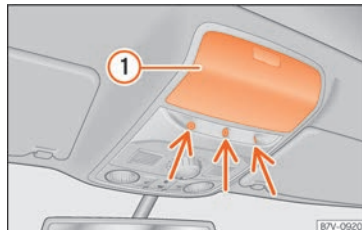


Fig. 93 On the roof console: passenger compartment monitoring sensors.

It is a monitoring or control function incorporated in the anti-theft alarm which detects unauthorised vehicle entry by means of ultrasound.



The vehicle interior monitoring and anti-tow sensor (tilt sensor) are automatically switched on when the anti-theft alarm is switched on. In order to activate it, all the doors and the rear lid must be closed.

If the "Safe" »» page 101 security system is switched off, the vehicle interior monitoring and the tow-away protection are automatically disconnected.

Activation

- Close the storage compartment »» Fig. 93
① on the roof console, otherwise the interior monitoring function (arrow) is not guaranteed to work freely.
- It is automatically switched on when the anti-theft alarm is activated.

Deactivation

- Open the vehicle with the key, either mechanically or by pressing the  button on the remote control. The time period from when the door is opened until the key is inserted in the contact should not exceed 15 seconds, otherwise the alarm will be triggered.
- Press the  button on the remote control twice. The volumetric sensor and tilt sensors will be deactivated. The alarm system remains activated.

The vehicle interior monitoring and the anti-tow system are automatically switched on again next time the vehicle is locked.

If you wish to switch off the vehicle interior monitoring and the anti-tow system, it must be done each time that the vehicle is locked; if not, they will be automatically switched on.

The vehicle interior monitoring and the anti-tow system should be switched off if animals are left inside the locked vehicle (otherwise, their movements will trigger the alarm) or when, for example, the vehicle is transported or has to be towed with only one axle on the ground.

False alarms

Interior monitoring will only operate correctly if the vehicle is completely closed. Please observe related legal requirements.

The following cases may cause a false alarm:

- Open windows (partially or fully).
- Panoramic/tilting sunroof open (partially or completely).
- Movement of objects inside the vehicle, such as loose papers, items hanging from the rear vision mirror (air fresheners), etc.

Note

- **If the vehicle is relocked and the alarm is activated without the volumetric sensor function, relocking will activate the alarm with all its functions, except the volumetric sensor. This function is reactivated when the alarm is switched on again, unless it is deliberately switched off.**
- **If the alarm has been triggered by the volumetric sensor, this will be indicated by**

a flashing of the warning lamp on the driver door when the vehicle is opened. The flash is different to the flash indicating the alarm is activated.

- **The vibration of a mobile phone left inside the vehicle may cause the vehicle interior monitoring alarm to trigger, as both sensors react to movements and shakes inside the vehicle.**
- **If on activating the alarm, any door or the rear lid is open, only the alarm will be activated. The vehicle interior monitoring and the anti-tow system will only be activated once all the doors are closed (including the rear lid).**

Doors

Introduction

The doors and rear lid can be locked manually and partially opened, for example if the key or the central locking is damaged.

WARNING

- Opening and closing doors carelessly can cause serious injury.
- **If the vehicle is locked from outside, the doors and windows cannot be opened from the inside.** »

- Never leave children or disabled people alone in the car. They could be trapped in the car in an emergency and will not be able to get themselves to safety.
- Depending on the time of the year, temperatures inside a locked and closed vehicle can be extremely high or extremely low resulting in serious injuries and illness or even death, particularly for young children.

WARNING

Getting in the way of the doors and the rear lid is dangerous and can lead to serious injury.


- Open and close the doors and the rear lid only when there is nobody in the way.

CAUTION

When opening and closing in an emergency, carefully disassemble components and then reassemble them carefully to avoid damage to the vehicle.



Warning lamp

It lights up

At least one vehicle door is open or not correctly shut. 

Do not continue driving! Open the corresponding door and close it immediately.

Several warning and control lamps light up for a few seconds when the ignition is switched on, signalling that the function is being verified. They will switch off after a few seconds.

If a door is open or not properly closed, the warning lamp  or  will light up on the instrument panel.

Depending on the vehicle equipment, a symbol may be displayed on the dash panel screen instead of the warning lamp. The indication is also visible when the ignition is switched off. The indication disappears around 15 seconds after the vehicle has been locked.

Emergency unlocking or locking of the driver's door

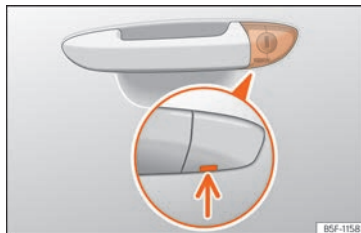


Fig. 94 Driver door handle: Concealed lock cylinder.

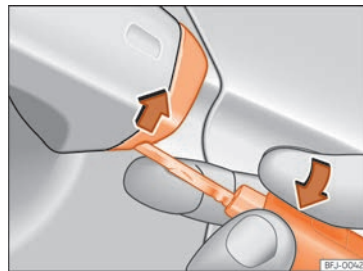


Fig. 95 Driver door handle: lever the cover off

If the central locking system should fail to operate, the driver door can still be locked and unlocked by turning the key in the lock.

As a general rule, when the driver door is locked manually all other doors are locked. When it is unlocked manually, only the driver door opens. Please observe the instructions relating to the anti-theft alarm system **>>> page 101.**

- Unfold the vehicle key blade **>>> page 93.**
- Insert the key shaft into the lower opening in the cover on the driver door handle **>>> Fig. 95** then remove the cover upwards.
- Insert the key blade into the lock cylinder to unlock or lock the vehicle.

Special characteristics

- The anti-theft alarm will remain active when vehicles are unlocked. However, the alarm will not be triggered »» page 101.
- After the driver door is opened, you have 15 seconds to switch on the ignition. Once this time has elapsed, the alarm is triggered.
- Switch the ignition on. The electronic immobilizer recognises a valid vehicle key and deactivates the anti-theft alarm system.

Note

The anti-theft alarm is not activated when the vehicle is locked manually using the key shaft »» page 95.

Locking the front passenger door and the sliding doors manually




Fig. 96 On the front of the sliding door: emergency lock, hidden by a rubber seal.



Fig. 97 Emergency locking of the vehicle using the vehicle key

The front passenger door and the sliding doors can be locked manually. The anti-theft alarm is **not** activated in this case.

- Open the door.
- Remove the rubber cap to the front of the door. The rubber cap is marked with a lock symbol  »» Fig. 96.
- Unfold the vehicle key blade »» page 93.
- Insert the key shaft horizontally into the opening and moved the coloured lever forward »» Fig. 97.
- Replace the rubber cap and close the door.
- Check if the door is locked.
- Carry out the same operation on the other doors if necessary.
- Have the vehicle checked by a specialised workshop.

Note

The doors can be opened and unlocked individually from the inside by pulling the door handle. To open, pull the inner door release lever twice »» page 95.

Sliding doors

Introduction

WARNING

If a sliding door is not correctly closed, it could open unexpectedly when driving and cause serious injuries.

- Stop immediately and close it.
- When closing, ensure that the sliding door has closed correctly. A closed sliding door should be flush with the corresponding parts of the bodywork.
- Only open and close sliding doors when no body is in the way of the door.

WARNING

If a sliding door is not fully open, it could close unexpectedly and cause serious injuries.

- Always open the sliding door fully. »

⚠ WARNING

Opening sliding doors while driving is dangerous. These doors may be pushed open or closed when the vehicle accelerates or brakes and cause serious injuries.

- Never open the sliding doors when the vehicle is in movement.

Manually opening and closing the sliding door

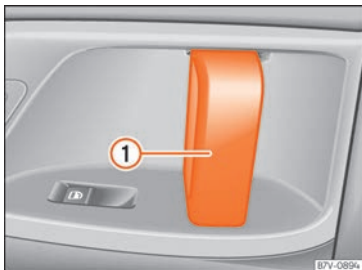


Fig. 98 On the sliding door: door handle ①.

Opening the sliding door from the outside.

- When the sliding door is released, open the door fully by pulling on the outside handle.

Opening the sliding door from the inside

- When the sliding door is released, open the door fully by pulling on its interior handle » Fig. 98 ①.

Closing the sliding door

- Pull on the inside or outside door handle and close the sliding door, pushing it gently. Make sure that it is completely closed.

Electrically opening and closing the sliding door

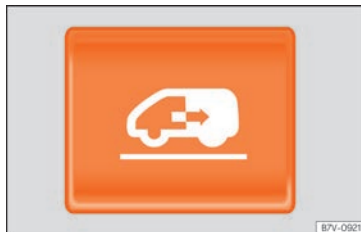


Fig. 99 On the instrument panel, on the vehicle key and on the inside lining of the sliding door: button to open and close an electric sliding door.

All of the electric sliding doors can be opened and closed manually using more force.

Electrical opening of the sliding door

- Press the » Fig. 99 button on the dash panel, on the remote control key and on the interior lining of the sliding door. The sliding door opens with the rollback anti-trap function as long as the button is not pressed again.

- **OR:** pull briefly on the interior or exterior door handle. The sliding door opens automatically.

Electrical closing of the sliding door

- Press the » Fig. 99 button on the dash panel, on the remote control key and on the interior lining of the sliding door. The sliding door closes with the rollback anti-trap function as long as the button is not pressed again. As it closes, a warning sound is given.

- **OR:** pull briefly on the interior or exterior door handle. The sliding door closes with the roll-back function. As it closes, a warning sound is given.

i Note

- When the fuel tank flap is open, the right-hand side electric sliding door is locked and can only be opened manually.
- If the window of a sliding door is lowered them this door cannot open fully.

Anti-trap function of the electric sliding doors


The rollback anti-trap function of the electric sliding doors can reduce the risk of injury when opening and closing the sliding doors »» » ⚠.

If an object gets in the way of the sliding door while it is *closing*, it will open again.

If an object gets in the way of the sliding door while it is *opening*, the door will be immobilised at this point.

- Check the reason for which the sliding door does not open or close.
- Try to open or close the sliding door again.

To close the sliding door without the rollback anti-trap function

- Turn off the ignition and turn it on again.
 - Press and hold the  button »» » Fig. 99.
- The sliding door closes with full force!**

⚠ WARNING

Closing the electric windows without the anti-trap function can cause serious injury.

- Always close the sliding doors carefully.
- Nobody should ever get in the way of the electric sliding doors, especially when closing without the anti-trap function.

- The anti-trap function does not prevent fingers or other parts of the body getting pinched against the window frame and causing injury.

Electric child lock

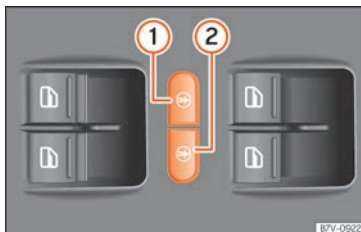


Fig. 100 On the driver's door: electric child lock buttons.

The electric child lock prevents the sliding doors and their electric windows from being opened and closed. The electric window and door lock controls can be disconnected and connected separately.

Activate and deactivate the electric child lock

- *Activate*: Press button ① or ②.
- *Deactivate*: Press the button again.

The yellow control lamp  indicates that the feature is on for the corresponding button.

⚠ WARNING

When the electric child safety function is activated, the sliding door can be opened from the outside only.

- Never leave children or disabled people alone in the vehicle if the doors are to be locked. Therefore, passengers will be locked inside the vehicle. They could be trapped in the car in an emergency and will not be able to get themselves to safety. Individuals locked in the vehicle can be exposed to very high or very low temperatures.
- Depending on the time of the year, temperatures inside a locked and closed vehicle can be extremely high or extremely low resulting in serious injuries and illness or even death, particularly for young children.

Rear lid

Introduction

The rear lid unlocks and locks together with the doors.

On vehicles with Keyless Access, the rear lid unlocks automatically when it is opened »» » page 98.

»

⚠ WARNING

Careless and unsuitable locking, opening and closing of the rear lid can cause accidents and serious injury.

- The rear lid must not be opened when the reverse or rear fog lights are lit. This may damage the tail lights.
- Do not close the rear lid by pushing it down with your hand on the rear window. The glass could smash. Risk of injury!
- Ensure the rear lid is locked after closing it. If not, it may open unexpectedly while driving.
- Closing the rear lid without observing and ensuring it is clear could cause serious injury to you and to third parties. Make sure that no one is in the path of the rear lid.
- Never drive with the rear lid open or half-closed, exhaust gases may penetrate into the interior of the vehicle. Danger of poisoning!
- Never leave the vehicle unattended or allow children to play inside or next to it, especially if the rear lid is open. Children could enter the luggage compartment, close the rear lid and become trapped. A locked vehicle can reach extremely high and low temperatures, depending on the time of year, thus causing serious injuries, illness or even death.

⚠ CAUTION

Before opening or closing the rear lid, make sure that there is enough space to open or close it, e.g. when pulling a trailer or in a garage.

i Note

Before closing the rear lid, make sure that the key has not been left inside the luggage compartment.

i Note

At outside temperatures of less than 0°C (+32°F), the pressurised gas struts cannot always automatically lift the rear lid. In this case, open the rear lid manually.

Warning lamp**🚗 It lights up**

The rear lid is open or not correctly shut. 🚗
Do not continue driving! Open the rear lid and close it again.

Several warning and control lamps light up for a few seconds when the ignition is switched on, signalling that the function is being verified. They will switch off after a few seconds.

The 🚗 warning lamp appears on the dash panel if the rear lid is open or not properly closed.

Depending on the vehicle equipment, a symbol may be displayed on the dash panel instead of the warning lamp. The indication is also visible when the ignition is switched off. The indication disappears around 15 seconds after the vehicle has been locked.

⚠ WARNING

If the rear lid is not correctly closed, it could open unexpectedly when driving and cause serious injuries.

- Always stop immediately and close the rear lid.
- Ensure that the rear lid has been locked into place by the element on the lock carrier when you close it.

Opening the rear lid

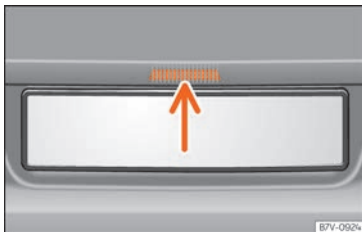


Fig. 101 Opening the boot hatch from the outside



Fig. 102 Detailed view of the centre console: rear lid unlocking button.


Before opening the rear lid, always remove any load on its luggage rack.

Opening the rear lid


- Unlock the vehicle or open a door.

- Raise and open the rear lid by pressing the button »» **Fig. 101** (arrow).

Opening with the vehicle key

- Press the  button on the vehicle key until the rear lid opens automatically.

To open using the centre console control

- Press the  button on the centre console »» **Fig. 102**. The rear lid will be automatically opened.
- The button is still operative when the ignition is switched off.

Closing the rear lid



Fig. 103 Rear lid open: space for pulling.

Closing the rear lid


- Grab the handgrip inside the rear lid »» **Fig. 103** (arrow).

- Push the rear lid downwards until it locks into place in the lock.
- Ensure that it is correctly closed by pulling on it firmly.

Locking the rear lid

If you unlock the vehicle without opening any doors or the rear lid, it will lock again automatically after 30 seconds. This function prevents the vehicle from remaining unlocked if the unlocking button is pressed by mistake.

Locking is only possible when the rear lid is correctly and fully closed.

- The rear lid is also locked by a central locking.
- If the vehicle rear lid is locked or unlocked using the  button of the vehicle key, when it is closed again it will lock automatically.
- A closed but not locked rear lid will lock automatically at a speed above about 9 km/h (7 mph).

WARNING

Unsuitable or careless closing and locking of the rear lid could cause serious injuries.

- **Never leave the vehicle unattended, or allow children to play inside or around the vehicle without supervision, especially if the rear lid is open. Children could enter the luggage compartment, close the rear lid and become trapped. A locked vehicle**

»

can be subjected to extremely high and low temperatures, depending on the time of year, thus causing serious injuries/illness and even death.

Note

Before closing the rear lid, make sure that the key has not been left inside the luggage compartment.

Operate the rear lid electrically

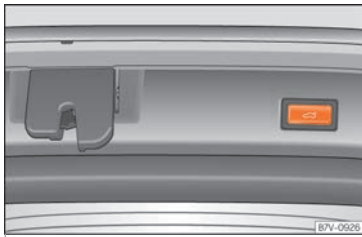




Fig. 104 Button with rear lid open



Fig. 105 Opening the boot hatch from the outside

Opening the rear lid





- Press and hold the  button on the vehicle key until the rear lid opens automatically.
- **OR:** press and hold the  button on the centre console for approximately one second **»» Fig. 102.**
- **OR:** press the **»» Fig. 105** boot hatch button (arrow).


In case of difficulty or obstruction, automatic opening of the rear lid is interrupted.

Electronically opening the rear lid does not work when a trailer is electrically connected and hitched to a factory fitted tow hitch **»» page 301.**

The rear lid can be opened manually by applying more force.

Closing the rear lid

- Press and hold the  button on the vehicle key for approximately 1 second.
- **OR:** press and hold the  button on the centre console for approximately one second **»» Fig. 102.**
- **OR:** press the **»» Fig. 105** boot hatch button (arrow).
- **OR:** press the  button on the open rear lid **»» Fig. 104** **»»  in Introduction on page 108.**
- **OR:** manually push the rear lid down to close it.



The rear lid will move down to the closed position to close and lock itself automatically using the power-close feature **»»  in Introduction on page 108.**

In case of difficulty or obstruction, automatic closing of the rear lid is interrupted and it will open slightly.

Check why the rear lid could not close.

Attempt to close it once more.

Interrupting the opening and closing process

Rear lid opening and closing can be stopped by pressing one of the  buttons. Each time one of the  buttons is pressed, the rear lid moves to its initial position.

Then, it can be opened or closed by hand. To do this, apply a little more force.

Memorising the opening angle

The rear lid must be at least half open to memorise an opening angle.

- Stop automatic opening in the opening position required »» page 110.
- Hold down the button »» Fig. 104 with the rear lid open for at least three seconds. The opening angle is memorised.

Memorisation is confirmed by blinking of the hazard warning lights and an audible warning.

To fully open the boot hatch again, the opening angle must be memorised once more.

- Release the rear lid and open it to the memorised height.
- Push the rear lid all the way up. To do this, apply a little more force.
- Hold down the button »» Fig. 104 with the rear lid open for at least three seconds.
- The opening angle is reset to the original factory setting.

⚠ WARNING

It is possible that the rear lid does not open completely or, if it is open, closes alone if a large amount of snow has built up on it or if

a luggage rack is fitted. In this case, the rear lid must be supported.

⚠ CAUTION

- When using a trailer, ensure that there is sufficient space to open and close the rear lid.
- Before opening the rear lid, any kind of equipment carrier should be removed, for example a bicycle carrier.

⚠ CAUTION

In case of repeated short-term use, the system is turned off to avoid overheating.

- When it has cooled, it may be used once again. During this time, the rear lid may be manually opened or closed applying a little more effort.
- If the vehicle battery is disconnected or the fuse blows when the rear lid is open, the rear lid system must be re-initialised. To do this, close the rear lid.

Rear lid with sensor-controlled opening (Easy Open)



Fig. 106 Rear lid with sensor-controlled opening (Easy Open).

If there is a valid vehicle key in the vicinity of the rear lid, it is possible to unlock and open it by moving one foot in the area of the sensors located under the rear bumper.

- Stand in front of the rear bumper, in the middle.
- With a brisk movement, bring your foot and lower leg as close as you can to the bumper. The lower part of the leg needs to be close to the upper sensor area and your foot must be close to the lower sensor area »» Fig. 106 ①.
- Quickly remove your foot and lower leg from the sensor areas »» Fig. 106 ②. The rear lid will be automatically opened.
- If the rear lid fails to open, repeat the procedure after a few seconds.

»

To notify that the rear lid has been opened with the Easy Open function, the turn lights blink twice.

Switching the Easy Open function on or off

The Easy Open function can be activated and deactivated in the **Vehicle settings** menu of the infotainment system »» page 73.

⚠ WARNING

If there is a valid key in the proximity of the rear lid, in some cases the Easy Open function may be accidentally activated and the rear lid will open, for example, when sweeping under the rear bumper, when directing a water jet or high pressure steam to the area or when carrying out maintenance work or repairs in that area. If accidentally opened, the rear lid could injure somebody situated in its area of operation or cause material damage.

- Therefore, always make sure that there is no unsupervised valid key in the area near the rear lid.
- Before carrying out any maintenance or repair work on the vehicle, always disable the Easy Open feature via the infotainment system.
- Before washing the vehicle, always disable the Easy Open feature via the infotainment system.

- Before attaching a bicycle rack or a trailer, »» page 301, always disable the Easy Open feature via the infotainment system.

Emergency unlocking of the rear lid



Fig. 107 Detail of the luggage compartment: access to emergency unlocking.



Fig. 108 Detail of the luggage compartment: emergency unlocking

The rear lid can be unlocked from inside in the event of an emergency (e.g. no battery).

There is a groove in the luggage compartment allowing access to the emergency opening mechanism.

Unlocking the rear lid from inside the luggage compartment

- Remove equipment to access the inside of the rear lid.
- Remove the rectangular cover from the inner trim of the rear lid »» Fig. 107.
- Move the unlocking lever »» Fig. 108 **A** in the direction of the arrow to unlock the rear lid.
- Manually open the rear lid.

Window controls

Electrically opening and closing the windows

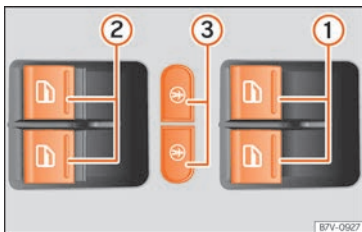




Fig. 109 Detail of the driver's door: window controls, as well as electric child lock buttons.

- Opening the window: press the button .
- Closing the window: pull the button .

Buttons on the driver door

- ① For the front electric windows.
- ② For the sliding door electric windows.
- ③ To lock the sliding doors and their windows.

The front and rear electric windows can be operated by using the controls on the driver door. The other doors each have a switch for their own window.



Always close the windows fully if you park the vehicle or leave it unattended »» .

You can use the electric windows for approx. 10 minutes after switching off the ignition if neither the driver door nor the front passenger door has been opened and the key has not been removed from the ignition.



Convenience open/close function

The electric windows can be opened or closed from outside using the vehicle key:

Convenience opening:

- Press and hold the  button on the remote control key until all the windows and the sunroof have reached the desired position.
- **OR:** First unlock the vehicle using the  button on the remote control key and then keep the key in the driver door lock until all the windows and the sunroof have reached the required position.

Convenience closing:

- Press and hold button  on the remote control key until all the windows and the sunroof are closed »» .
- **OR:** Keep the key in the driver door in the "lock" position until all the windows and the sunroof are closed.

During convenience closing, first the windows and then the sliding sunroof will be closed.

In the **Settings – comfort** menu, there are different settings for operating the windows »» page 73.

One-touch opening and closing

The one-touch automatic opening and closing is used to open or close the windows completely. It will not be necessary to hold the button of the corresponding electric window.

For the automatic raising function: pull the button for the corresponding window upwards until it reaches the second position.

For the automatic lowering function: push the button for the corresponding window upwards until it reaches the second position.

Stop automatic movement: push or pull on the button of the corresponding window.

Resetting one-touch opening and closing


The one-touch opening and closing function is not active after the vehicle battery has been disconnected or is flat and will have to be reset.

- Close all windows and doors.
- Pull the button of the corresponding window and hold it for one second in this position. »»

- Release the button and pull upwards and hold again. The one-touch function is now ready for operation.

The automatic one-touch electric windows can be reinitialised individually or several at a time.

WARNING

Observe the safety warnings »  in Introduction on page 103.

- Incorrect use of the electric windows can result in injury.
- Never close the rear lid without observing and ensuring it is clear, to do otherwise could cause serious injury to you and third parties. Make sure that no one is in the path of a window.
- If the ignition is switched on, the electric equipment could be activated with risk of injury, for example, in the electric windows.
- The doors can be locked using the remote control key. This could become an obstacle for assistance in an emergency situation.
- Therefore always take the key with you when you leave the vehicle.
- The electric windows will work until the ignition has been switched off and one of the front doors has been opened.
- If necessary, use the safety switch to disable the rear electric windows. Make sure that they have been disabled.


- For safety reasons, you should only use the remote control open and close functions within about 2 metres of the vehicle. To avoid injuries, always keep an eye on the windows when pressing the button to close them. The windows stop moving as soon as the button is released.

Note

If the window is not able to close because it is stiff or because of an obstruction, the window will automatically open again » page 114. If this happens, check why the window could not be closed before attempting to close it again.


Window anti-trap function

The roll-back function reduces the risk of injury when the electric windows close.

- If a window is obstructed when closing automatically, the window stops at this point and lowers immediately » .
- Next, check why the window does not close before attempting to again.
- If you try within the following 10 seconds and the window closes again with difficulty or there is an obstruction, the automatic closing will stop working for 10 seconds.
- If the window is still obstructed, the window will stop at this point.

- If there is no obvious reason why the window cannot be closed, try to close it again by pulling the tab within ten seconds. The window closes with maximum force. **The roll-back function is now deactivated.**
- If more than 10 seconds pass, the window will open fully when you operate one of the buttons. One-touch closing is reactivated.

WARNING

Observe the safety warnings »  in Electrically opening and closing the windows on page 114.

- The roll-back function does not prevent fingers or other parts of the body getting pinched against the window frame. Risk of accident.

Sunroof

Introduction

The sunroof only works when the ignition is switched on. Once the ignition has been switched off, you can still open or close the sunroof for a few minutes provided the driver door and the front passenger door are not opened.

⚠ WARNING

If the sunroof is used negligently or without paying due attention, it can cause serious injury.

- Open or close the sunroof and the sun blind only when no one is in their path of movement.
- Never leave any key inside the vehicle when exiting.
- Never leave a child or any other person who may need help in the vehicle, especially if they have access to the vehicle key. If using the key unattended, they could lock the vehicle, start the engine, switch on the ignition and activate the sunroof.
- After switching off, it is still possible to open or close the sunroof during a short space of time provided that neither the driver nor passenger door is opened.

⚠ CAUTION

- To prevent damage, during winter temperatures remove any ice or snow that might be on the car roof before opening the sunroof or adjusting the tilt position.
- Before leaving the vehicle or in case of rainfall, always close the sunroof. With the sunroof open or in a tilted position, water can enter the interior and can cause considerable damage to the electrical system. As a result, other damage can occur in the vehicle.

i Note

- Leaves and other loose objects that accumulate on the sunroof rails should be regularly cleaned away either by hand or with a vacuum.
- If the sunroof does not work correctly, the anti-trap function will not work either. Contact a specialised workshop.

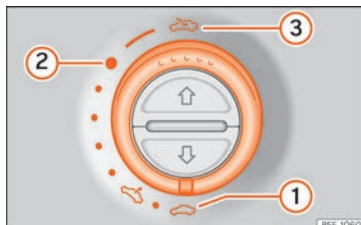
Opening and closing the sunroof

Fig.110 On the interior roof lining: turn the switch to open and close.

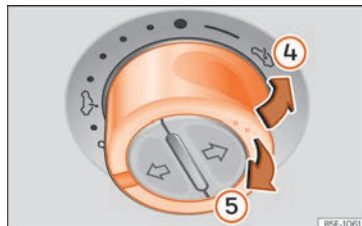


Fig.111 On the interior roof lining: press the switch and pull on it to raise and lower the roof.

To open the sunroof, the switch must be in the position **1**.

- Open: turn the switch to position **»» Fig.110 3**.
- Comfort position: turn the switch to position **»» Fig.110 2**.
- Close: turn the switch to position **»» Fig.110 1**.
- Lift: Push the switch to position **»» Fig.111 4**. For an intermediate position, hold down the switch until you reach the desired position.
- Lower: pull the switch to position **»» Fig.111 5**. For an intermediate position, hold down the switch until you reach the desired position.

Opening and closing the sunshade blind

✓ Valid for vehicles: with sun blinds

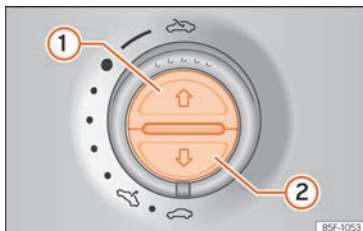


Fig. 112 On the interior roof lining: sunshade blind buttons.

Once the ignition has been switched off, you can still open or close the sun blind for a few minutes provided the driver door and the front passenger door are not opened.

Opening completely (automatic function)

- Press button »» Fig. 112 ① briefly.

Closing completely (automatic function)

- Press the button ② briefly.

Stop automatic operation

- Press button ① or button ② briefly.

To set the intermediate position

- Press button ① or button ② until the correct position is set.

Convenience function to open or close the sunroof

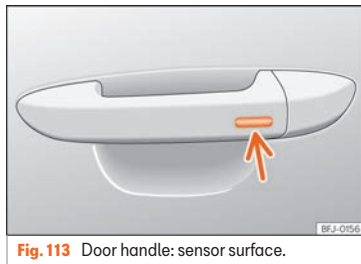


Fig. 113 Door handle: sensor surface.

The sunroof can be opened and closed with the convenience function, just like the windows.

Using the remote control

- Keep the locking or unlocking button pressed to open or close the roof. If you release the button the opening or closing will stop.

Using the Keyless Access system (only closing)

- Press and hold the locking sensor surface »» Fig. 113 (arrow) on the door handle to close the sunroof. If you release the sensor surface, the closing movement stops.

Anti-trap function of the panoramic sunroof and sunshade

The anti-trap function can reduce the risk of injury when closing the sunroof and the sun blind »» Fig. 113 (arrow). If the sunroof or sun blind encounter resistance or an obstacle when closing, they reopen immediately.

- Check why the sunroof or sun blind do not close.
- Try to close the sunroof or sun blind again.
- If the sunroof or sun blind cannot be closed due to an obstacle or some resistance, it stops at the corresponding position and then opens. For automatic closing, a new closing attempt might take place.
- If the sunroof or sun blind is still unable to close, close it without the anti-trap function.

Closing the sunroof or sun blind without the anti-trap function

- The switch »» Fig. 110 should be in the "closed" position ①.

- *Glass roof*: within approx. 5 seconds of the activation of the anti-trap function, keep the control pulled backwards »» Fig. 111 (arrow ⑤) until the roof is completely closed.
- *Sun blind*: within approximately 5 seconds of activating the roll-back function, press and hold button »» Fig. 112 ② until the blind is fully closed.
- **The sunroof or sun blind close without the anti-trap function intervening!**
- If the sunroof or sun blind will still not close, visit a specialised workshop.

⚠ WARNING

Closing the sunroof or sun blind without the anti-trap function can cause serious injuries.

- Always be careful when closing the sunroof and sun blind.
- No person should ever remain in the way of the sunroof or sun blind, especially when closing without the anti-trap function.
- The anti-trap function does not prevent fingers or other parts of the body from becoming trapped against the roof frame and injuries occurring.

Lights

Vehicle lighting

Control lamps

☀ It lights up

Driving light totally or partially faulty.

Fault in the cornering light .

☀ Flashes

Fault in the cornering light system.
Contact a specialised workshop.

☁ It lights up

Rear fog light switched on »» page 119.

☁ It lights up

Front fog lights switched on »» page 119.

↔ It lights up

Left or right turn signal.
The control lamp flashes twice as fast when a vehicle or trailer turn signal is faulty. If necessary, check the vehicle and trailer lighting.

Hazard warning lights on »» page 122.

☁ It lights up

Main beam on or flasher on »» page 119.

Ⓜ It lights up

The Light Assist system is on »» page 120.

Several warning and control lamps light up for a few seconds when the ignition is switched on, signalling that the function is being verified. They will switch off after a few seconds.

⚠ WARNING



Observe the safety warnings »» ⚠ in Control and warning lamps on page 88.

Headlight switch



Fig. 114 Dash panel: lights control. »


- Turn the switch to the required position
»» Fig. 114.

Sym- bol	Ignition switch- ed off	Ignition is switched on
0	Fog lights, dipped beam and side lights off.	Light off or day-time driving light on.
AUTO	The "Coming home" and "Leaving home" guide lights may be switched on.	Automatic control of dipped beam and daytime running light.
	Side light on.	
	Dipped beam off; if necessary, the side light comes on for a time.	Dipped beam switched on.

The driver is personally responsible for the correct use and adjustment of the lights in all situations.


Automatic dipped beam headlight control **AUTO**

The automatic dipped beam control is merely intended as an aid and is not able to recognise all driving situations.

When the light switch is in position **AUTO**, the vehicle lights and the instrument panel and switch lighting switch on automatically in the following situations »» :

- The photo sensor detects *darkness*, for example, when driving through a tunnel. They switch off when adequate lighting is detected.
- The rain sensor detects rain and activates the wipers. They switch off when the wipers have not been activated for a few minutes.

Daytime running lights



The daytime running lights consist of individual lights, integrated in the front headlights. These lights come on when the daytime running lights are switched on. On vehicles equipped with LED tail lights, the rear side light is switched on as well »» .

The daytime running lights turn on every time the ignition is switched on, if the switch is in position **0** or **AUTO**, according to the level of exterior lighting.

When the light switch is in position **AUTO**, a light sensor automatically switches dipped beam on and off (including the control and instrument lighting) or the daytime running lights depending on the level of exterior lighting.

Audible warnings to advise the driver that the lights have not been switched off

If the key is not in the ignition and the driver door is open, an audible warning signal is heard in the following cases: this will remind you to turn the light off.

- When the parking light is on »» page 119.
- When the light switch is in position  or .

WARNING

If the road is not well lit and other road users cannot see the vehicle well enough or at all, accidents may occur.

- The automatic dipped beam control (**AUTO**) only switches on the dipped beam when there are changes in light conditions but not, for example, when it is foggy.

WARNING

The side lights or daytime running lights are not bright enough to illuminate the road ahead and to ensure that other road users are able to see you.

- Always use your dipped beam head lights if it is raining or if visibility is poor.
- Never drive with daytime lights if the road is not well lit due to weather or lighting conditions.
- On vehicles with rear lights with bulbs, when activating the daytime running light the rear lights are not switched on. A vehicle which does not have the rear lights on may not be visible to other drivers in the darkness, in the case of heavy rain or in conditions of poor visibility.

⚠ WARNING

If the headlights are set too high and not used correctly, there is a risk of dazzling or distracting other road users. This could result in a serious accident.

- Always make sure that the headlights are correctly adjusted.

i Note

- The legal requirements regarding the use of vehicle lights in each country must be observed.
- The dipped beam headlights will only work with the ignition on. The side lights come on automatically when the ignition is turned off.

Fog lights



Fig. 115 Dash panel: lights control.

The warning lamps Ⓜ or Ⓝ also show, on the light switch or instrument panel, when the front fog lights are on.

- **Turning on the front fog lights Ⓜ :** pull the light switch out from its first click position \ggg **Fig. 115** ①, from positions Ⓝ , Ⓜ or **AUTO**.
- **Turning on the rear fog light Ⓝ :** pull the light switch fully out ② from position Ⓝ , Ⓜ or **AUTO**.
- To switch off the fog lights, press the light switch or turn it to position **0**.

i Note

The rear fog light can dazzle drivers behind you. You should use the rear fog light only when visibility is very poor.

Turn signal and main beam lever

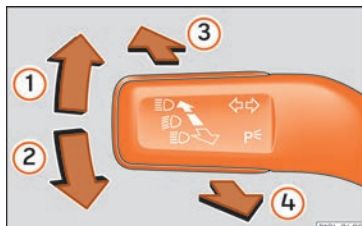


Fig. 116 Turn signal and main beam lever.

Move the lever to the required position:

- ① Right turn light or right-hand parking light (ignition switched off).
- ② Left turn light or left-hand parking light (ignition switched off).
- ③ Main beam on: control lamp Ⓜ lit up on the instrument panel.
- ④ Light flash: on with the lever pushed. Control lamp Ⓜ lit up.

Push the lever all the way down to turn off the corresponding function.

Convenience turn signals

When the ignition is switched on, move the lever as far as possible upwards or downwards and release the lever. The turn signal will flash three times.

The convenience turn signals can be activated and deactivated from the **Settings > Lights & Visibility** menu on the instrument panel screen \ggg **page 73**.

In vehicles that do not have the corresponding menu, this function can be deactivated in a specialised workshop.

Parking light P

The parking lights will only work with the ignition off. If said light is on, an audible warning will sound while the driver door is open. \gg

- Switch the ignition off.
- Move the turn signal lever up or down.

When the parking light is switched on, the front side light and the tail light on the corresponding side of the vehicle turn on.

WARNING

Improper or lack of use of the turn signals, or forgetting to deactivate them can confuse other road users. This could result in a serious accident.

- Always give warning when you are going to change lane, overtake or when turning, activating the turn signal in good time.
- As soon as you have finished changing lane, overtaking or turning, switch the turn signal off.

WARNING

Incorrect use of the headlights may cause accidents and serious injury, as the main beam may distract or dazzle other drivers.

Note

- If the turn signal lever is left on after the key has been taken out of the ignition lock, an acoustic signal sounds when the driver door is opened. This is intended as a reminder to switch off the turn signal, unless you wish to leave the parking light on.

• If the convenience turn signals are operating (three flashes) and the other convenience turn signals are switched on, the active part stops flashing and only flashes once in the new part selected.

• The turn signal only works when the ignition is switched on. The hazard warning lights also work when the ignition is switched off.

• If a turn signal on the vehicle or trailer is faulty, the warning lamp flashes twice as fast as usual.


• The main beam headlights can only be switched on if the dipped beam headlights are already on.

• In cold or damp weather conditions, the headlights, tail lights and turn signals may mist up inside temporarily. This is normal and in no way affects the useful life of the vehicle lighting system.

• The parking light does not activate automatically if the left- or right-hand turn signal is left on and the ignition is disconnected.

Main beam assist (Light Assist)


The main beam assist acts within the limits of the system and depending on environmental and traffic conditions. Once switched on, the system is activated as of a speed of about 60


km/h (37 mph) and is deactivated below about 30 km/h (18 mph) » .

When the system is activated and the camera detects other vehicles that may be dazzled, the main beam is automatically switched off. Otherwise, the main beam is automatically switched on.


The main beam assist generally detects illuminated areas and deactivates the main beam when passing through a town, for example.

Switching the main beam assist on

- Turn on the ignition and turn the light switch to the position **AUTO** » **Fig. 114**.
- From the base position, press the turn signal and main beam headlights lever forwards » **Fig. 116** .

When the main beam assistant is on, the  indicator lamp lights up on the instrument cluster display.

Switching the main beam assist off

- Turn the light switch to a position other than **AUTO** » **Fig. 114**.
- **OR:** if the main beam assist is on, pull the turn signal and main beam headlight lever backwards » **Fig. 116** .
- **OR:** push the turn signal and main beam headlight lever forwards to manually turn on

the main beam. The main beam assist will then be deactivated.

System limitations

In the following cases, the main beam headlight must be switched off manually because the main beam assist will not disconnect it on time or disconnect it at all:

- On roads with insufficient lighting with very reflective signs
- If road users are insufficiently lit up, e.g. pedestrians or cyclists.
- On closed curves, when the traffic in the opposite direction is partially hidden, on pronounced slopes or inclinations.
- On roads with traffic in the opposite direction and with a central reservation barrier where the driver can see over it e.g. lorry drivers.
- In the event of fog, snow or heavy rain
- In the event of dust or sand storms
- If the windscreen is damaged in the camera's field of vision.
- If the camera's field of vision is misted up, dirty or covered by a sticker, snow or ice.
- If the camera is damaged or if the power supply has been cut off.

WARNING

The convenience features of the main beam assist should not encourage the taking of risks. The system is not a replacement for driver concentration.

- You are always in control of the main beam and adapting it to the light, visibility and traffic conditions.
- It is possible that the main beam headlight control does not recognise all driving situations and is limited under certain circumstances.
- When the field of vision of the camera is dirty, covered or damaged, operation of the main beam control may be affected. This also applies when changes are made to the vehicle lighting system, for example, if additional headlights are installed.

CAUTION

To avoid affecting the operation of the system, take the following points into consideration:

- Clean the field of vision of the camera regularly and make sure it is free of snow and ice.
- Do not cover the field of vision of the camera.
- Check that the windscreen is not damaged in the area of the field of vision of the camera.

Note

- The headlight flasher can be turned on and off manually at any time with the turn signal and main beam lever »» page 119.
- If there are objects that radiate light in the camera's area of influence, e.g. a portable navigation system, this may affect the operation of the main beam assist system.

Cornering lights

Dynamic cornering lights (AFS)

The adaptive headlights only operate when the dipped beam is on and at speeds of over 10 km/h [6 mph]. On bends, the adaptive headlights automatically improve lighting on the road ahead.

The adaptive cornering lights can be activated or deactivated from the infotainment system.

Static cornering lights

When turning slowly to change direction or going round a tight bend, the static cornering lights automatically come on. The static cornering lights only work at speeds of less than 40 km/h [25 mph].

The static cornering lights may be incorporated into the fog lights or the front headlights, depending upon the equipment.

“Coming home” and “Leaving home” function

The “Coming home” and “Leaving home” function lights up the vehicle’s immediate proximity when getting into and out of it in the dark. When switched on, the front position and dipped beam lights, tail lights and license plate light come on.

The “Coming home” function should be switched on manually. However the “Leaving home” function is automatically controlled by a photo sensor.

The duration of the headlight turn off delay can be set in the **Settings > Lights and Visibility** menu, and the function can be activated or deactivated » page 73.

Activating the “Coming Home” function

- Switch the ignition off.
- Activate the headlight flashers for *approximately 1 second*.

When the driver door is opened, the “Coming Home” lighting comes on. The *delay in switching off the headlights* is counted from when the last door or boot hatch is closed.

The “Coming Home” lighting turns off in the following cases:

- Automatically, once the headlight turn off delay has elapsed.

- Automatically, when a vehicle door or the rear lid is still open 30 seconds after starting the engine.
- When the rotary light switch is turned to position 0 » page 117.
- With the ignition is switched on.

Activating the “Leaving Home” function

- Unlock the vehicle using the remote control.
- The “Leaving Home” function is only activated when the light switch is in position **AUTO** and the light sensor detects darkness.

The “Leaving Home” lighting switches off in the following cases:

- Automatically, when the “Leaving Home” delay period ends (default 30 sec).
- When the vehicle is locked using the remote control.
- When the light switch is turned to position 0.
- With the ignition is switched on.

Lighting around the exterior mirrors

The lighting around the exterior mirrors illuminates the door area on entering and leaving the vehicles. It comes on when the vehicle is unlocked, when the vehicle door is opened and when the “Coming home” or “Leaving home” function is switched on. If the equipment includes the light sensor, the lighting

around the exterior mirrors only comes when it is dark.

Note

To activate the “Coming Home” and “Leaving Home” function, the rotary light switch must be in position **AUTO** and the light sensor must detect darkness.

Hazard warning lights



Fig. 117 Dash panel: hazard warning lights switch

The hazard warning lights are used to draw the attention of other road users to your vehicle in emergencies.

If your vehicle breaks down:

1. Park your vehicle at a safe distance from moving traffic.

2. Press the button to switch on the hazard warning lights »» ⚠.
3. Switch the ignition off.
4. Apply the electronic parking brake.
5. For a manual gearbox, engage 1st gear; for an automatic gearbox, move the gear lever to P.
6. Use the warning triangle to draw the attention of other road users to your vehicle.
7. Always take the vehicle key with you when you leave the vehicle.

All turn signals flash simultaneously when the hazard warning lights are switched on. The two turn signal turn signal lamps ⇄ and the turn signal lamp in the switch ⚠ will flash at the same time. The simultaneous hazard warning lights also work when the ignition is switched off.

Emergency braking warning

If the vehicle brakes suddenly and continuously at a speed of more than 80 km/h (50 mph), the brake light flashes several times per second to warn the vehicles driving behind. If you continue braking, the hazard warning lights will come on automatically when the vehicle comes to a standstill. They switch off automatically when the vehicle starts to move again.

⚠ WARNING

- The risk of an accident increases if your vehicle breaks down. Always use the hazard warning lights and a warning triangle to draw the attention of other road users to your stationary vehicle.
- Due to the high temperatures that the catalytic converter can reach, never park in an area where the catalytic converter could come into contact with highly inflammable materials, for example dry grass or spilt petrol. This could start a fire.

i Note

- The battery will run down if the hazard warning lights are left on for a long time, even if the ignition is switched off.
- The use of the hazard warning lights described here is subject to the relevant statutory requirements.

Light range control



Fig. 118 Next to the steering wheel: headlight range control.

The headlight range control »» **Fig. 118** is modified according to the value of the headlight beam and the vehicle load status. This offers the driver optimum visibility and the headlights do not dazzle oncoming drivers »» ⚠.

The headlights can only be adjusted when the dipped beam is switched on.

To reset, turn switch »» **Fig. 118**:

Value	Vehicle load status ^{a)}
-	Two front occupants, luggage compartment empty
1	All seats occupied, luggage compartment empty

»

Value	Vehicle load status ^{a1)}
2	All seats occupied, luggage compartment full. With trailer and minimum drawbar load.
3	Driver only, luggage compartment full. With trailer and maximum drawbar load.

^{a1)} If the vehicle load does not correspond to those shown in the table, it is possible to select intermediary positions.

Dynamic headlight range control

The control is not mounted in vehicles with dynamic headlight range control. The headlight range is automatically adjusted according to the vehicle load status when they are switched on.

⚠ WARNING

Heavy objects in the vehicle may mean that the headlights dazzle and distract other drivers. This could result in a serious accident.

- Adjust the light beam to the vehicle load status so that it does not blind other drivers.

Stick stickers on the headlights or adapt them

In those countries where vehicles drive on the other side of the road to the home country, the asymmetric dipped beam may dazzle drivers of oncoming vehicles.

The direction of the headlights can be adjusted from the instrument cluster, in the **Tourist Light** sub-menu of the menu **Configuration > Lights and visibility >>> page 74**.

For those vehicles in which it is not possible to adjust the headlights from the menu, adhesive strips are used to cover certain parts of the headlamp cover or the headlights may be adjusted at a specialised workshop. For further information, please refer to a specialised workshop. SEAT recommends visiting a technical service.

i Note

Use of the **Tourist Light** option and the adhesives on the headlights is only allowed if they are to be used for a short period of time. To modify the direction of the headlights permanently, please take the vehicle to a specialised workshop. SEAT recommends visiting a technical service centre.

Interior lights

Instrument and switch lighting





Fig. 119 Next to the steering wheel: instrument and switch lighting adjuster

Depending on the vehicle's equipment, the intensity of the lighting of the instruments and controls can be infinitely adjusted by turning the regulator while the lights are on >>> **Fig. 119**.

Interior and reading lights

Knob	Function
0	Turns off the interior lights.
☞	Turning the interior lights on or off.

Knob	Function
	The interior lights come on automatically when you unlock the vehicle, open a door or remove the key from the ignition. The light goes out a few seconds after closing all the doors, when locking the vehicle or connecting the ignition.
	Turning the reading light on and off

Glove compartment and luggage compartment lighting

When opening and closing the glove compartment on the front passenger side and the rear lid, the respective light will automatically switch on and off.

Background lighting

The background lighting in the front covering of the ceiling lights up the controls on the centre console from above when the side light or dipped beam lights are on.

In addition, the lever on the door moulding can also be illuminated.

Note

The reading lights switch off when the vehicle is locked using a key or after several minutes if the key is removed from the ignition. This prevents the battery from discharging.

Visibility

Windscreen wiper and rear window wiper systems

Control lamp

It lights up

Windscreen cleaning fluid level too low. Refill the windscreen washer tank as soon as you have the opportunity to do so »» page 324.

Several warning and control lamps light up for a few seconds when the ignition is switched on, signalling that the function is being verified. They will switch off after a few seconds.

Window washer lever

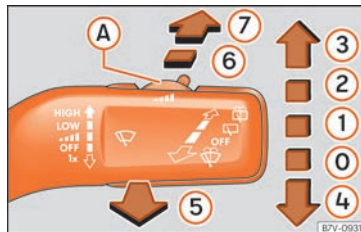




Fig. 120 Operating the windscreen wiper and rear wiper.

More the lever to the required position:

0	OFF	Windscreen wipers off.
1		Wiper intervals. Use control »» Fig. 120 (A) to set the interval (vehicles without rain sensor), or the sensitivity of the rain sensor.
2	LOW	Slow wipe.
3	HIGH	Continuous wipe.
4	1x	Short wipe. Brief press, short clean. Hold the lever down for more time to increase the wipe frequency.
5		Windscreen washer. The windscreen washer function is activated by pushing the lever towards the steering wheel, and the wipers operate simultaneously. »

More the lever to the required position:

6



Interval wipe for rear window. The wiper will wipe the window approximately every six seconds.

7



The rear window wash function is activated by pressing the lever, and the rear wiper starts simultaneously.

⚠ WARNING

In cold conditions you should not use the wash/wipe system unless you have warmed the windscreen with the heating and ventilation system. The windscreen washer fluid could otherwise freeze on the windscreen and obscure your view of the road.

ⓘ CAUTION

If the ignition is switched off while the windscreen wipers are switched on, they complete their wipe and return to the rest position. When the ignition is switched back on, the windscreen wiper will continue to operate at the same wiping level. Ice, snow and other obstacles on the windscreen may damage the wiper and the windscreen wiper motor.

- If necessary, remove snow and ice from the windscreen wipers before starting your journey.
- Do not switch on the windscreen wipers if the windscreen is dry. Cleaning with the

windscreen wipers while dry can cause damage.

- In icy conditions, always check that the wiper blades are not frozen to the glass before using the wipers. In cold weather, it may help to leave the vehicle parked with the wipers in service position »» page 50.

ⓘ Note

- The windscreen and window wipers only function when the ignition is switched on and the bonnet or rear lid, respectively, are closed.
- The interval wipe speed varies according to the vehicle speed. The faster the vehicle is moving, the more often the windscreen is cleaned.
- The rear wiper is automatically switched on when the windscreen wiper is on and the car is in reverse gear.

Wiper functions

Windscreen wipers performance in different situations

- If the vehicle is stopped, the activated position temporarily moves to the previous position.
- The air conditioner comes on for approximately 30 seconds in air recirculation mode when the windscreen washer is activated, ❄

to prevent the smell of the windscreen washer fluid entering the inside the vehicle.

- When wiping at intervals, the intervals vary according to the speed. The higher the vehicle speed the shorter the intervals.

Heated windscreen washer jets

The heating only thaws the frozen jets, it does not thaw the water in the washer hoses. When the ignition is switched on the heated windscreen washer jets automatically adjust the heat depending on the ambient temperature.

Headlight washer system

The headlight washer cleans the glass of the headlights and only works when the dipped beam headlights are on. After switching on the ignition, the headlights are also washed when the automatic wiper is activated for the first time and then every fifth time.

Regularly clean dirt that has become encrusted on the headlights, e.g., remains of insects.

To ensure the headlight washers work correctly in winter, clean away any snow that may be present on the jet covers located on the bumper. If necessary, remove ice with an anti-ice spray.

ⓘ Note

- The wiper will try to wipe away any obstacles that are on the windscreen. The

wiper will stop moving if the obstacle blocks its path. Remove the obstacle and switch the wiper back on again.

- If you stop the vehicle with the windscreen wiper in position 1 or 2, it will automatically change to a lower position speed. The set speed will be resumed when the vehicle pulls away.
- The windscreen will be wiped again approximately 5 seconds after the windscreen washer has been activated, provided the vehicle is moving ("drip" function). If you activate the wipers less than 3 seconds after the "drip" function, a new wash sequence will begin without performing the last wipe. For the "drip" function to work again, you have to turn the ignition off and then on again.

Rain sensor

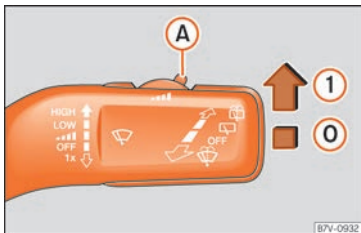


Fig. 121 Wiper lever: adjust the rain sensor **A**



Fig. 122 Rain sensor sensitive surface

The rain sensor controls the frequency of the windscreen wiper intervals, depending on the amount of rain **»** **Δ**. The sensitivity of the rain sensor can be adjusted manually. Manual wipe **»»** page 125.

Move the lever to the required position

»» **Fig. 121:**

- ⊙** Rain sensor off.
- ①** Rain sensor on; automatic wipe if necessary.
- A** Setting sensitivity level of rain sensor
 - Set control to the right: high sensitivity.
 - Set control to the left: low sensitivity.

When the ignition is switched off and then back on, the rain sensor stays on and starts operating again when the windscreen wipers are in position **①** and the vehicle is travelling at more than 16 km/h (10 mph).

Modified behaviour of the rain sensor

Possible causes of faults and mistaken readings on the sensitive surface **»»** **Fig. 122** of the rain sensor include:

- Damaged wipers: a film of water on the damaged blades may lengthen the activation time, reduce the washing intervals or result in a fast and continuous wipe.
- Insects: insects on the sensor may trigger the windscreen wiper.
- Salt on the road: in winter, salt spread on the roads may cause an excessively long wipe when the windscreen is almost dry.
- Dirt: dry dust, wax, coating on glass (Lotus effect) or traces of detergent (car wash) may reduce the effectiveness of the rain sensor or make it react more slowly, later or not at all.
- Windscreen crack: the impact of a stone will trigger a single wipe cycle with the rain sensor on. Next the rain sensor detects the reduction in the sensitive surface area and adapts accordingly. The behaviour of the sensor will vary with the size of the damage caused by the stone.

⚠ WARNING

The rain sensor may not detect enough rain to switch on the wipers.

- If necessary, switch on the wipers manually when water on the windscreen obstructs visibility.

»

Note

- Clean the sensitive surface of the rain sensor regularly and check the blades for damage »» Fig. 122 (arrow).
- To remove wax and coatings, we recommend a window cleaner containing alcohol.
- Do not put stickers on the windscreen in front of the rain sensor. This may cause sensor disruption or faults.

Mirrors

Interior mirror anti-dazzle function

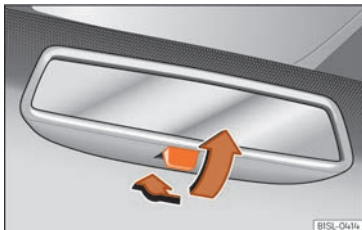


Fig. 123 Manual anti-dazzle function for rear vision mirror

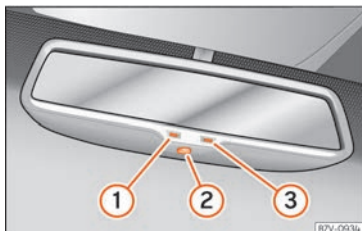


Fig. 124 Automatic anti-dazzle function for rear vision mirror

Interior mirror with manual anti-dazzle function

- Basic position: place the lever at the bottom of the mirror in the forward position.
- Pull the lever to the back to select the anti-dazzle function »» Fig. 123.

Automatic anti-dazzle function for interior mirror

Key to Fig. 124:

- ① Control lamp
- ② Control
- ③ Light incidence sensor

This function can be activated and deactivated by pressing the rear-view mirror switch »» Fig. 124 ②. When it is activated, the warning lamp lights up ①.

When the ignition is on, the sensor ③ automatically moves the rear vision mirror to the anti-dazzle position depending upon the incidence of the light from behind.

The automatic anti-dazzle function is deactivated when reverse gear is engaged or the interior or reading lights are on.

⚠ WARNING

In the event that an automatic anti-dazzle rear vision mirror breaks, an electrolyte fluid may leak. This could cause irritation to the skin, eyes and respiratory organs. If you come into contact with this liquid, it must be rinsed with large quantities of water. If necessary, get medical help.

ⓘ CAUTION

In the event that an automatic anti-dazzle rear vision mirror breaks, an electrolyte fluid may leak. This liquid attacks plastic surfaces. Clean it with a wet sponge as soon as possible.

Note

- If the light falling on the interior mirror is obstructed (e.g. with the sun blind), the anti-dazzle mirror with automatic adjustment will not operate perfectly.
- When the interior lights are on or reverse gear engaged, the mirrors do not darken

with automatic adjustment for anti-dazzle position.

- If you have to stick any type of sticker on the windscreen, do not do so in front of the sensors. Doing so could prevent the anti-dazzle function from working well or even from working at all.

Adjusting the exterior mirrors

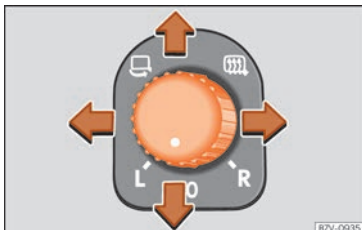


Fig. 125 Detail of the driver's door: control for the exterior mirror.

Turn the control to the corresponding position:

- L/R** Turning the knob to the desired position, adjust the mirrors on the driver side [L,

left] and the passenger side [R, right] to the direction desired.

- ☞ Depending on the equipment fitted on the vehicle, the mirrors may be heated according to the outside temperature.
- ☞ Folding in mirrors.

Synchronized regulation of the exterior mirrors

In the **Settings – Convenience** menu, select whether or not the mirrors should move in synchronisation »» page 73.

- Turn the knob to position **L**¹⁾.
- Adjust the left-hand exterior mirror. The right exterior mirror will be adjusted at the same time (synchronised).
- If necessary, correct the right-hand rear-view mirror: rotate the control to position **R**¹⁾.

Automatic anti-dazzle exterior mirror, driver side

The automatic anti-dazzle exterior mirror is controlled in the same way as the automatic anti-dazzle rear vision mirror »» page 128.

Store the reverse settings for the passenger exterior mirror

- Select the vehicle key in which the setting is to be stored.
- Use this key to unlock the vehicle.
- Connect the automatic parking brake.
- Turn the exterior mirror knob to position **R** (passenger side).
- Switch the ignition on.
- Move the gear lever to neutral.
- Access the **Settings** menu on the instrument panel display using the multifunction steering wheel buttons and select **Convenience**.
- Select the **Rear vision mirror adjustment** function (if it is already checked, uncheck it and check the option again).
- Select reverse gear.
- Adjust the front passenger side exterior mirror so that you can see, for example, the kerb area.
- The new position of the mirror will be stored automatically and allocated to the vehicle key that was used to unlock the vehicle. For vehicles with seat memory, please see »» page 135.

¹⁾ Regulation in right-hand drive vehicles is symmetrical.

Activating the passenger exterior mirror settings

- Turn the exterior mirror knob to position **R**.
- With the ignition switched on, select reverse gear.
- The stored position of the passenger exterior mirror for reverse gear is deleted when driving forwards at 15 km/h (9 mph), or if the knob is turned from position **R** to another position.

⚠ WARNING

Convex or wide-angle exterior mirrors give a larger field of vision. However, they make objects look smaller and further away than they really are. If you use these mirrors to estimate the distance to vehicles behind you when changing lane, you could misjudge the distance. Risk of accident!

⚠ WARNING

Fold and unfold the exterior mirror, taking care to avoid injuries.

- Only fold or unfold the exterior mirror when there is no-one in the way of the mirror.
- When moving the mirror, take care not to trap fingers between the mirror and the mirror bracket.

⚠ CAUTION

- If one of the mirror housings is knocked out of position (e.g. when parking), the mirrors must first be fully retracted with the electric control. Do not readjust the mirror housing by hand, as this will interfere with the mirror adjuster function.
- Before washing the vehicle in an automatic car wash, please make sure to retract the exterior mirrors to prevent them from being damaged. Electrically retractable exterior mirrors must not be folded in or out by hand. Always use the electrical power control.

i Note

- If the electrical adjustment should fail to operate, both of the mirrors can be adjusted by hand by lightly pressing the edge of the mirror glass.
- The fold-in function on the exterior mirrors will not activate at speeds over 40 km/h (25 mph).

Sun protection

sun blind

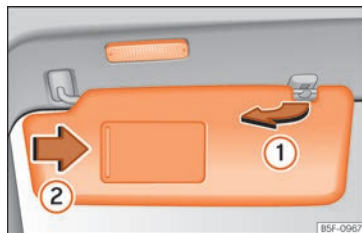


Fig. 126 Sun visor

Options for adjusting driver and front passenger sun visors

- Lower the sun visor towards the wind-screen.
- The sun visor can be pulled out of its mounting and turned towards the door »» Fig. 126 ①.
- Swing the sun visor towards the door, longitudinally backwards.

There is a vanity mirror on the sun visor, with a cover. When the cover is opened ② a light comes on.

The lamp goes out when the vanity mirror cover is closed or the sun visor is pushed back up.

⚠ WARNING

Folded sun blinds can reduce visibility.

- Always store sun blinds and visors in their housing when not in use.

i Note

The light above the sun visor automatically switches off after a few minutes in certain conditions. This prevents the battery from discharging.

Rear side window curtains

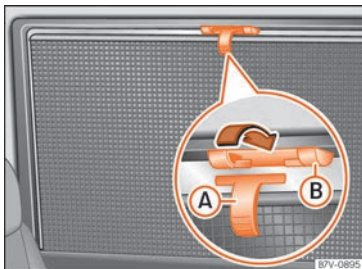


Fig. 127 On the rear right-hand window: curtain.

The sun blinds for the vehicle interior are fitted in the side panels of the windows.

- Pull the sun blind by the handle »» Fig. 127 **A** up to the top.
- Fasten the support rod to both anchorages in the correct spaces **B**. Verify that the sun blind when extended is hooked safely in the correct spaces **B**.
- To put the sun blind away, unhook it at the top and lower by hand »» **!**

⚠ CAUTION

To prevent damage to the blind or the interior trim, do not lower the sun blind "quickly".

Seats and headrests

Adjusting seats

Manual adjustment of the front seats

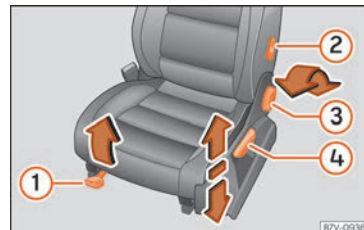


Fig. 128 Front left seat controls

- 1 Forwards/backwards: pull the lever and move the seat. The seat must engage when the lever is released!
- 2 Lumbar support: move the lever until the required position is achieved.
- 3 Tilting the backrest: turn the hand wheel.
- 4 Raise/lower: pull the lever up or push down (several times if necessary) from its home position. »

⚠ WARNING

Incorrect seat adjustment may lead to accidents and severe injuries.

- Only adjust the seats when the vehicle is stationary, as the seats could move unexpectedly while the vehicle is in motion and you could lose control of the vehicle. Furthermore, an incorrect position is adopted when adjusting the seat.
- Adjust the height, position and inclination of the front seats only when their movement area is empty.
- Make sure there are no objects in that area.
- Make sure that the movement and locking areas of the seats are clean.

⚠ WARNING

Incorrectly using upholstery and seat covers might cause an accidental activation of the electrical seat adjustment system and make it move unexpectedly while driving. This might cause loss of control of the vehicle and thus accidents or injuries. Moreover, the electrical components of the front seats might be damaged.

- Never attach or place seat upholstery or covers on the electric controls.
- Never use upholstery or seat covers that have not been explicitly authorised for the seats of the vehicle.

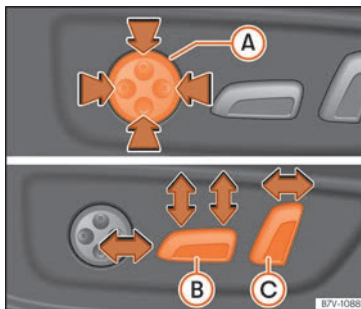
Electric driver's seat adjustment

Fig. 129 Driver's seat: electric seat settings.

- A** Adjust the lumbar support: press the button according to the desired position.
- B** Seat forwards/backwards: press the button forwards/backwards.
- Seat up/down: Press the rear part of the button up/down. To adjust the angle of the seat cushion, press the front of the button up/down.
- C** Backrest further upright/further reclined: press the button forwards/backwards.

Mechanically and electrically adjusted controls can be combined on the seat.

⚠ WARNING

- If the electric front seats are used negligently or without paying due attention, it can cause serious injury.
- The front seats can also be electrically adjusted when the ignition is switched off. Never leave a child or any other person who may need help in the vehicle.
- In the event of an emergency, electrical adjustment can be stopped by pressing any control.

⚠ CAUTION

To avoid damaging the electrical components of the front seats, please refrain from kneeling on the seat or applying sharp pressure at a single point to the seat cushion and backrest.

i Note

- It may not be possible to electrically adjust the seat if the vehicle battery is very low.
- If the engine is started while the seats are being electrically adjusted, the adjustment will stop.

Adjusting the rear seats

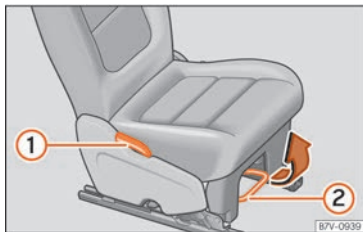


Fig. 130 Adjusting rear seats

Adjusting the seat backrest

- Pull the lever and adjust the seat backrest to the desired position » Fig. 130 ① » ❶. The seat backrest must be engaged when the lever is released!

There is a handle instead of the lever on the third row of seats and on the central seat of the second row. It is used in the same manner as the lever.

Move the seat backwards or forwards.

Only in the second row of seats:

- Pull the lever and move the seat ②. The seat must be engaged when the lever is released!

⚠ CAUTION

- Tilting the seat backrest of the second row of seats fully back could damage the luggage compartment tray. Remove the tray before adjusting the seat backrest.
- Objects in the luggage compartment could cause damage when moving the rear seats forwards or backwards.

Headrest

Introduction

The possibilities for the adjustment and disassembly of the headrests are described below. Always make sure that the seats are correctly adjusted » page 12.

All seats are equipped with a headrest. The rear headrests have been designed exclusively for the corresponding seat of the second or third row. Therefore, never mount them on any other seat.

Correct adjustment of headrest

Adjust the headrest so that its upper edge is at the same level as the top of your head and under no circumstances below eye level. Keep the back of your head always as close to the headrest as possible.

In vehicles with horizontally adjustable headrests on the front seats, move the headrest as close as possible to the back of the head.

Adjusting the headrest for short people

Lower the headrest completely, even if your head is below its upper edge. In the lowest position, there may be a small distance between the headrest and the backrest.

Adjusting the headrest for tall people

Push the headrest up as far as it will go.

⚠ WARNING

If travelling with the headrests removed or improperly adjusted, the risk of severe or fatal injuries in the event of accidents and sudden braking or manoeuvres increases.

- Always travel with the headrest correctly installed and adjusted.
- To decrease the risk of cervical injuries in the event of an accident, adjust the headrest correctly based on your height, always making sure that its upper edge is at the same height as the top of the head, but never below eye level. Keep the back of your head always as close to the headrest as possible and centred.
- Never adjust the headrest while the vehicle is in motion.
- Under no circumstances should the rear passengers travel while the headrests are in the non-use position.



ⓘ CAUTION

When assembling and disassembling the headrests, do not let them meet the top lining of the vehicle, the back rest of the front seat or other parts of the vehicles. If not, this could damage the vehicle.

Adjusting the headrests

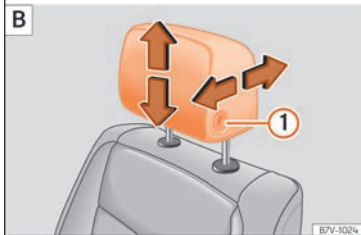
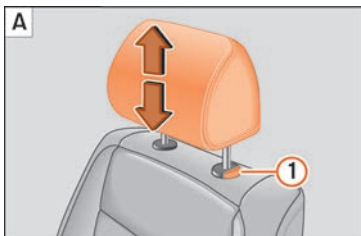


Fig. 131 Front seat: headrest adjustment.

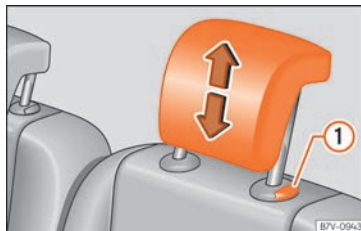


Fig. 132 Adjust the headrests in the second or third row of seats

Adjusting the height of the headrests

- Move the headrest up or down in the direction of the corresponding arrow. Regarding the rear headrest, to both raise and lower, press the button »» Fig. 131 ①; for the rear headrests it is only necessary to press the button »» Fig. 132 ① to lower them »» Δ in Introduction on page 133.
- The headrest must lock correctly in one position.

Adjusting the front headrests horizontally

- Move the headrest forward or back in the direction of the corresponding arrow while pressing the button »» Fig. 131 ① [B].
- The headrest must lock correctly in one position.

Removing and fitting the headrests

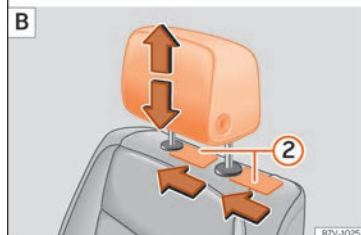
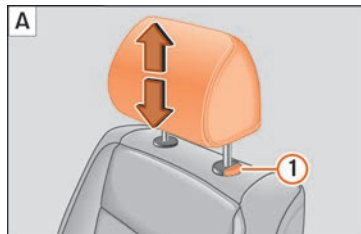


Fig. 133 A: Fitting the headrests with no possibility of lengthways direction adjustment; B: Fitting the headrests with lengthways direction adjustment

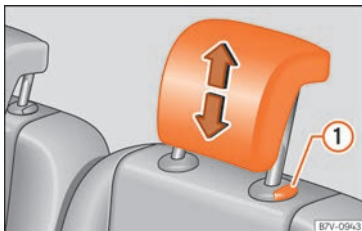


Fig. 134 Fitting the headrests in the second or third row of seats

Removing and fitting the front headrests without longitudinal adjustment

- Push the headrest up as far as it will go » » » ⚠ in Introduction on page 133.
- Pull out the headrest by pressing the button completely » » » Fig. 133 A ①.
- To refit, insert the headrest into the holes in the backrest, pushing it down until it engages, while pressing button ①.

Removing and fitting the front headrests with longitudinal adjustment

- Push the headrest up and backward as far as it will go » » » ⚠ in Introduction on page 133.
- Place a flat object, e.g. a plastic card » » » Fig. 133 B ②, on both sides between the seat backrest cover and the end protector of

the seat backrest retaining bar and unlock the retaining bars with a little pressure.

- Completely pull out the headrest.
- When re-fitting, pull out the headrest's two retaining bars as far as possible and insert them into the holes in the seat back. Push downwards until the two bars click into place.

Removing the rear headrests

- If necessary, adjust the backrest of the seat so the headrest can be removed.
- Push the headrest up as far as it will go » » » ⚠ in Introduction on page 133.
- Remove the headrest completely while pressing button » » » Fig. 134 ①.

Fitting the rear headrests

- Unlock the rear seat backrest and fold it forward slightly » » » page 133.
- Place the headrest in the correct position on the guides of the corresponding backrest and insert it.
- Lower the headrest while pressing button ①.
- Raise the rear seat backrest and lock it.

⚠ WARNING

Remove the rear headrests only when it is necessary to fit a child seat. After removing a child seat, refit the headrest immediately.

Seat functions


Lumbar massage function




Fig. 135 On the side of the front seat: button for the lumbar massage function.

During the massage operation, the lumbar support will move in a way that massages the lumbar area of the back. While it is operating, the arch of the lumbar support can be adjusted using the corresponding control based on your personal preferences » » » page 12.

Connection

- Press the  button in the control panel of the seat.

Disconnection

- Press the  button again in the control panel of the seat.

»

Automatic off

- The lumbar massage will disconnect automatically after approx. 10 minutes.

Memory function

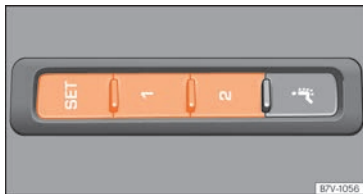


Fig. 136 Memory buttons on the outside of the driver seat

Memory buttons

The memory buttons can be used to save and turn on settings for the driver seat and the exterior mirrors.

Save the settings of the driver seat and the exterior mirrors while driving forward

- Apply the electronic parking brake.
- Move the gearshift to the neutral position.
- Switch the ignition on.
- Adjust the driver seat and the exterior mirrors.

- Press **SET** for longer than 1 second »» **Fig. 136**.
- Press the memory button in which to store the settings within approx. 10 seconds. A warning sound will confirm they have been stored.

Storing the passenger rear view mirror settings while driving in reverse


- Apply the electronic parking brake.
- Move the gearshift to the neutral position.
- Switch the ignition on.
- Press the required memory button.
- Select reverse gear.
- Adjust the front passenger exterior mirror so that you can see, for example, the kerb area well.
- The new position of the mirror will be stored automatically and allocated to the vehicle key that was used to unlock the vehicle.

Activating exterior mirror settings

- With the driver door open and the ignition turned off, push the memory button of the corresponding door briefly.
- **OR:** with the ignition switched on, hold in the corresponding memory button until the memorised position is reached.

To activate the memory function of the vehicle key

Condition: a position must be memorised in the memory.


- Open the driver-side door.
- Press and hold any memory button.
- Within three seconds of the move being completed, push the open button  on the vehicle key. An audible warning confirms the settings have been activated.

Adjusting the wing mirrors for driving and assigning driver seat settings to a vehicle key

- Activate the memory function of the vehicle key
- Adjust the front seat and the exterior mirrors.
- Lock the vehicle. The settings are assigned to the vehicle key.

To deactivate the memory function of the vehicle key

Condition: a position must be memorised in the memory.

- Press and hold the **SET** button »» **Fig. 136**.
- Within the following 10 seconds, push the open button  on the vehicle key. An audible warning confirms the settings have been deactivated.

Initialising the seat position memory

The position memory system must be restarted if, for example, the driver seat has been changed.

Restarting deletes all memories and assignments for the seat with position memory. The memory buttons can then be reprogrammed and the vehicle keys re-assigned.

- Open the driver door and do not get into the vehicle.
- Operating the seat settings from outside the vehicle.
- Tilt the backrest fully forward.
- Release the control to set the angle and then press again until an audible warning is heard.

⚠ WARNING

Adjust the memory function only when the vehicle is stationary.

i Note

The front passenger side exterior mirror automatically changes from the position stored for reversing as soon as the vehicle moves forward at a speed of at least 15 km/h [9 mph] or when the gear selection lever is changed to a position other than R.

Access aid for the third row of seats

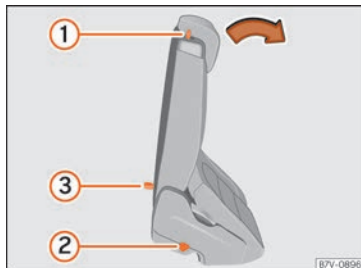


Fig. 137 Second row of seats:: access aid controls.

The outer seats of the second row can be folded to make it easier to get in and out of the third row of seats.

Folding down the second row seats

- If necessary, open the belt loop and wind up the seat belt by hand.
- If necessary, remove the side headrest of the integrated child seat »» page 36.
- If necessary, raise the armrests.
- Remove any objects located in the footwell of the second row of seats, where applicable »» ❶.
- Push the headrest down as far as it will go »» page 12.

- Push the lever »» Fig. 137 ❶ forwards and fold the backrest of the rear seat. This seat folds forward completely »» ⚠ and can still be moved further forward.
- Always take care when entering and leaving the vehicle »» ⚠.

Repositioning the seat in the second row

- Lift the backrest of the rear seat in an upright position. The entire seat folds backwards »» ⚠.
- Make sure that the rear seat is securely engaged so that the seat belts can provide proper protection in the rear seats. The red mark »» Fig. 137 ❷ should no longer be visible »» ⚠ in **Folding the rear seats down as a cargo surface on page 144.**

Emergency exit function

If the lever »» Fig. 137 ❶ does not work, e.g. after an accident, the seats on the second row can be folded forwards from the third row to allow vehicle occupants of the third row of seats to get out of the vehicle »» ⚠.

- Pull the handle »» Fig. 137 ❸ back and fold the backrest of the rear seat. The complete rear seat folds forward »» ⚠.

⚠ WARNING

Careless or uncontrolled use of the convenient entry assistant may result in severe injury and accident. »»

- Never use the convenient entry function when the vehicle is in motion.
- Avoid trapping or damaging the seat belt when folding the rear seats back.
- Keep your hands, fingers, feet and other body parts out of the hinges and the seat locking mechanism when folding and unfolding.
- Mats or other objects can be caught in the hinges of the seat backrests or rear seat. This could prevent the seat backrest from locking safely when positioned upright.
- All seat backrests must engage correctly for the seat belts on the rear seats to work properly. When the seat backrest of an occupied seat is not correctly locked in place, the passenger can be thrust forward with the seat backrest in case of sudden braking, sudden manoeuvres or an accident.
- A red mark on the side of the seat »» Fig. 137 ② indicates that the seat backrest is not engaged. The mark is no longer visible when it is correctly engaged.
- If the seat backrest or seat are folded down and are not correctly locked in place, no passenger should use them.
- When getting in or out, never lean or hold onto the folded seat on the second row of seats.

⚠ WARNING

If child seats are fitted to all the seats in the second row then it is possible that the seats of this row cannot be folded down from the third row of seats in the event of an accident. In the event of an emergency, passengers in the third row of seats will not be able to leave the vehicle or to help themselves.

- Child seats should not occupy all the seats of the second row if other passengers are to occupy the third row.

ⓘ CAUTION

- Before folding down the rear seat backrest for returning it to its position, adjust the front seats so that the headrests and seat backrests do not hit each other when folding and unfolding.
- Any objects located in the footwell of the second row of seats may be damaged on folding the rear seat forwards. Remove any objects before folding the seat down.

Adjusting or folding the backrest of the front passenger seat

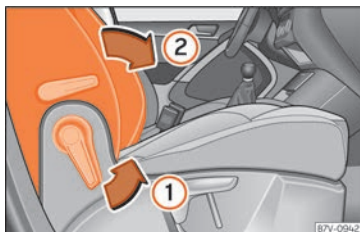


Fig. 138 Front passenger seat: fold the backrest of the seat forwards.



Fig. 139 Unlocking the folding backrest of the front passenger seat

The backrest of the front passenger seat can be folded and locked horizontally.

Folding the backrest of the front passenger seat forward

- Remove any objects from the front passenger seat cushion »» » ⚠.
- Move the passenger seat to its lowest position.
- Move the front passenger seat back as far as possible.
- Unlock the backrest of the front passenger seat in the direction of the arrow »» » Fig. 138 ①.
- Fold the backrest of the front passenger seat forwards in the direction of the arrow ② until it is horizontal.
- Once folded down, the backrest has to be locked safely.

When carrying objects on the folded down backrest of the passenger seat, the front airbag of this seat must be disabled »» » page 26.


Lifting the backrest of the front passenger seat

- When lifting the passenger backrest, make sure there are no objects or body parts within the hinge movement area.
- Lift the backrest of the front passenger seat by first unlocking it again »» » Fig. 139.
- Lift the backrest of the seat in an upright position.

- Once it is raised again, the backrest must be correctly engaged.

⚠ WARNING

Serious injuries can be caused if the passenger seat backrest is lowered or lifted without due care and attention.

- Only fold and lift the backrest of the front passenger seat when the vehicle is stationary.
- When folding down the passenger seat, always make sure there are no people or animals in the backrest area.
- While the passenger backrest is down, the front airbag must always be disabled and the PASSENGER AIR BAG OFF ; warning lamp must be on.
- When moving the passenger backrest up and down, keep your hands, fingers, feet and other body parts out of the operating area of the hinges and the locking mechanism of the seat.
- Mats or other objects can be caught in the hinges of the backrest of the front passenger seat. This would cause the backrest not to be locked in an upright position when lifting it.
- Once the backrest is up, it must be correctly engaged in an upright position. Otherwise, it could move unexpectedly and cause severe injuries.

⚠ WARNING

When folding down the passenger backrest, its anchor points and hinges are left uncovered and may cause severe injuries in the event of a sudden brake or accident.

- When the passenger seat backrest is lowered nobody else can travel in the corresponding seats (not even a child).
- When the passenger seat backrest is lowered, the only permitted seat is the rear seat behind the driver seat. This also applies to children travelling on a child seat.

Front centre armrest

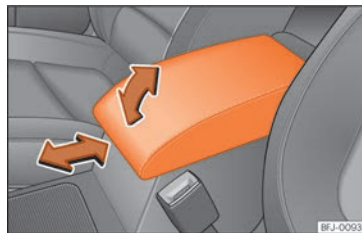


Fig.140 Front centre armrest

To lift the central armrest, lift it upwards in the direction of the arrow »» » Fig. 140, setting by setting. »»

To lower the armrest, first lift it to its highest position. Then lower it down.

To move the armrest horizontally, move it forward »» Fig. 140 or backward as much as possible in the direction of the corresponding arrow.

WARNING

The front centre armrest may obstruct the driver's arm movements, which could cause an accident and severe injuries.

- Keep the storage compartments of the centre armrest closed at all times while the vehicle is in motion.
- Never let anyone sit on the centre armrest while the vehicle is in motion, not even a child. This position is incorrect and may cause severe injuries.


Transport and practical equipment

Storing objects

Positioning the luggage and cargo

It is possible to carry objects and luggage in the vehicle, in a trailer »» page 301 and on the roof »» page 150. When doing so, please consider all legal provisions.

Placing luggage inside the vehicle safely

- Distribute the load in the vehicle as evenly as possible.
- Always place equipment and heavy objects in the boot »» .
- Position heavy items in the boot as far forward as possible.
- Take into account the maximum authorised weight per axle, as well as the maximum authorised weight of the vehicle »» page 357.
- Secure the objects to the fastening rings of the boot using appropriate chains or belts »» page 145.
- Also place small objects safely.
- Adapt tyre pressure to the load. Take into account the pressure adhesive of the tyres »» page 331.

- In vehicles equipped with tyre control system, adjust to the new load status if necessary »» page 334.

WARNING

Loose or unsecured objects can cause serious injury in case of sudden manoeuvring or braking or in case of an accident. Particularly if the airbag hits them when deploying and they are thrown across the inside of the vehicle. Please observe the following rules to minimise the risk of injury:

- Place all objects inside the vehicle safely.
- Secure all objects, little and large.
- Place the objects in the cabin in such a way that they can never reach the airbag deployment areas while the vehicle is in motion.
- Keep the storage compartments closed at all times while the vehicle is in motion.
- Place the objects in such a way that they never force any occupant of the vehicle to sit in an incorrect position.
- When transporting objects that take up a seat, never let anyone use that seat.
- Never leave hard, sharp or heavy objects loose in open storage compartment of the vehicle, on the cover behind the rear seat or on the dashboard.
- Remove all hard, sharp or heavy objects from the fabrics and bags inside the cabin and store them safely.

⚠ WARNING

The transport of heavy object changes vehicle handling and increases braking distance. Heavy objects that are not properly placed or secured may cause loss of control of the vehicle and thus severe injuries.

- Never put too much load in the vehicle. Both the carrying capacity as well as the distribution of the load in the vehicle have effects on the driving behaviour and braking ability.
- When transporting heavy objects, the driving behaviour of the vehicle varies due to the displacement of the centre of gravity.
- Always distribute the load in the vehicle as evenly and horizontally as possible.
- Always place heavy objects in the boot before the rear axle and as far away from it as possible.
- Objects in the luggage compartment that are unsecured could move suddenly and modify the handling of the vehicle.
- Adapt your speed and driving style at all times to suit visibility, weather, road and traffic conditions.
- Accelerate with particular care and caution.
- Avoid sudden braking and manoeuvres.
- Brake earlier than usual.

⚠ WARNING

- Never leave your vehicle unattended, especially when the rear lid is open. Children could climb into the luggage compartment, closing the door behind them; they will be trapped and run the risk of death.
- Close and lock all the doors and the rear lid when you leave the vehicle. Before you lock the vehicle, make sure that there are no adults or children in the vehicle.

ⓘ CAUTION

Electrical wires or, depending on the features, the antenna embedded into the rear windows could be damaged, even irreparably, if they are in contact with objects.

ⓘ Note

Straps for securing the load to the fastening rings are commercially available from accessory shops.

Luggage compartment

Luggage compartment shelf

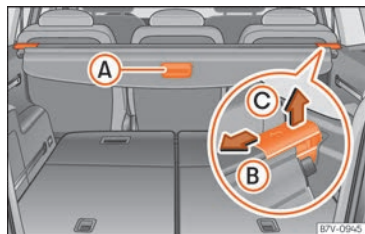


Fig. 141 In the luggage compartment: luggage compartment tray.



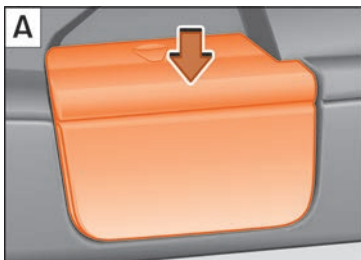


Fig. 142 Remove the shelf supports A then put them away safely B.

The rear shelf can be fitted behind the second or third row of seats » » » ⚠.

Opening the shelf

- Pull the shelf handle » » » Fig. 141 A a little bit backwards.

- Release the shelf upwards by the side supports and guide it forward.

Closing the shelf

- Pull the unfolded shelf evenly on the guide backwards.
- Secure the shelf using the left and right side supports.

Installing the shelf behind the second row of seats

- Place the shelf in its position in the side lining, left-hand side first.
- Release the shelf in the direction of the arrow » » » Fig. 141 B.
- Insert the shelf into the right-hand support, pressing down.

Installing the shelf behind the third row of seats

- Remove the shelf from the side trim support » » » Fig. 142 A. To do this, press the shelf upwards (arrow) and remove it.
- Open the compartment in the left-hand side boot lining » » » page 152 and hook the shelf to the rear of the compartment lid » » » Fig. 142 B.
- Close the rear left-hand side lining compartment.
- Place the shelf in its position in the side lining, left-hand side first.

- Lift the shelf off in direction of the arrow » » » Fig. 141 B.
- Insert the shelf into the right-hand support, pressing down.

Removing the shelf

- Release the shelf in the direction of the arrow » » » Fig. 141 B and lift it in the direction of the arrow C.
- Remove the shelf from the right-hand side support.
- **Moreover, when detaching the shelf behind the third seat row:** cover the supports of the side trims with their covers.
- **With only 5 seats:** support the released shelf by placing it on the front section of the boot floor » » » page 152.

⚠ WARNING

If the shelf is placed on one of the rear seats, this could cause serious injury in case of sudden braking or an accident.

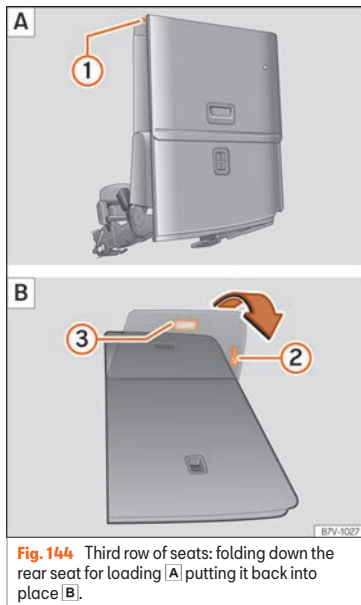
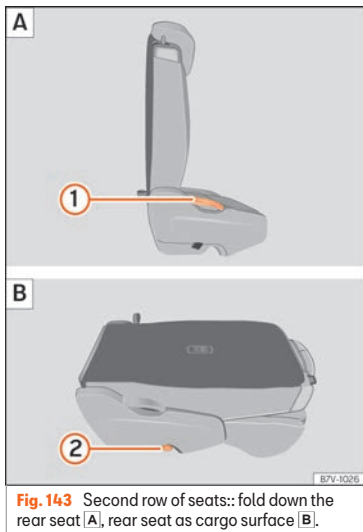
- Whenever it the third row seats are occupied, the shelf should be put behind this row.

⚠ WARNING

Unsecured or incorrectly secured objects or animals on the rear shelf could cause serious injuries in case of a sudden manoeuvre or braking or even an accident.

- Do not leave hard, heavy or sharp objects (loose or in bags) on the rear shelf.
- Never transport animals on the rear shelf.

Folding the rear seats down as a cargo surface



Each rear seat can fold down individually to extend the luggage compartment.

Folding the seats in the second row of seats for loading

- If necessary, open the belt loop and wind up the seat belt by hand.
- If required, remove the headrests from the integrated seats for children and refit them »» page 36.
- If necessary, raise the armrests.
- Remove objects from the footwell in front of and behind the rear seat »» ⓪.
- Move the rear seat all the way back.
- Push the headrest down as far as it will go »» page 12.
- In the middle seat, close the drinks carrier in the rear of the centre console, if necessary.
- Pull lever »» Fig. 143 ① back and fold the seat backrest forwards. The complete rear seat folds forward »» ⚠.
- Fold the seat backrest forwards until it locks into the load surface position »» Fig. 143 ⓑ.
- If necessary, pull on the lever »» Fig. 144 ② to move the seat to the required position.
- When the seat is folded down, no adults or children should travel in it »» ⚠.

Folding the seats in the third row of seats for loading

- If necessary, open the belt loop and wind up the seat belt by hand.
- Open the rear lid.

- Push the headrest down as far as it will go »» page 12.
- Remove objects from the footwell in front of and behind the rear seat »» ❶.
- Remove objects from the space below the rear seat.
- Remove the attachment elements and supports for the net from the rail system.
- Pull lever »» Fig. 144 ❶ back and fold the seat backrest forwards. The rear seat folds forward »» ⚠ and the cushion also moves forward.
- Fold the seat tray forward on top of the folded seat.
- When the seat is folded down, no adults or children should travel in it »» ⚠.
- Pull on the handle »» Fig. 144 ❷ to put the seat tray back in position.
- Pull the handle »» Fig. 144 ❸. The entire seat folds backwards.
- Press on the seat tray in the seat backrest until it is held in position by its magnets.
- Open the sliding door.
- Put the seat backrest into position and press firmly until it clicks into place.
- Pull on the rear seats and the seat backrest to ensure that they are correctly locked in place and that the seat belt protection is guaranteed for rear seat passengers.

Putting the seats in the second row back in place

- Pull lever »» Fig. 143 ❶ upwards and place the seat backrests in vertical position. The entire seat folds backwards.
- Pull on the rear seats and the seat backrest to ensure that they are correctly locked in place and that the seat belt protection is guaranteed for rear seat passengers.

Putting the seats in the third row back in place

- Open the rear lid.

- All seat backrests must engage correctly for the seat belts on the rear seats to work properly. When the seat backrest of an occupied seat is not correctly locked in place, the passenger can be thrust forward with the seat backrest in case of sudden braking, sudden manoeuvres or an accident.
- No seat must be occupied if the seat backrest or seat is folded or not correctly engaged.

⚠ CAUTION

- Before folding the rear seat backrest, adjust the front seats so that neither the headrest or backrest hit them when folded.
- Objects placed in the footrest area in front of and behind the rear seats can be damaged when seats are folded down or put back into position. Remove any objects in the way before folding seats down or repositioning them.
- Objects placed in the moulding on the back of the third row of seats can be damaged when folding down the seats or putting them back into position. Remove any objects in the way before folding seats down or repositioning them.
- The attachment elements and supports for the net partition placed on the rail system can be damaged when folding down seats from the third row or putting them back into position and these can also damage the seats themselves. Before folding

⚠ WARNING

Folding and lifting the rear seats carelessly without paying attention could cause serious injury.

- Never fold or lift the seats while driving.
- Do no trap or damage seat belts when raising the seat backrest.
- Keep your hands, fingers, feet and other body parts out of the hinges and the seat locking mechanism when folding and unfolding.
- Mats or other objects can be caught in the hinges of the seat backrests or rear seat. This could prevent the seat or seat backrest from locking securely in the vertical position.

down or repositioning the seats, remove the attachment elements and supports for the net from the rail system.

Fastening rings

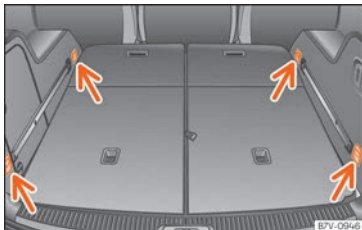


Fig. 145 In the luggage compartment: fastening rings.

There are fastening rings » **Fig. 145** on the front and rear of the boot to secure loose objects and luggage with fastening belts and cords.

On some models, the fastening rings are located right at the back, in the area of the lock carrier plate.

There are other fastening rings located to the left and right hand side of the second row footrests.

⚠ WARNING

If unsuitable or damaged belts or retaining straps are used, they could break in the event of braking or an accident. Objects could then be launched across the passenger compartment and cause serious or fatal injuries.

- Always use belts or straps that are suitable and in good condition.
- Tighten the belts and straps in a cross layout over the load placed on the boot floor and secure them to the fastening rings safely.
- Never exceed the maximum tensile load of the fastening rings when securing objects.
- Make sure that, particularly for flat objects, the upper edge of the load is higher than the fastening rings.
- Depending on the features, take into account the instruction panels on the boot on how to place the load.
- Never secure a child seat to the fastening rings.

i Note

- The maximum tensile load that the fastening rings can support is approx. 3.5 kN.
- Belts, straps and securing systems for the appropriate load can be obtained from specialised dealerships. SEAT recommends visiting a SEAT dealership for this.

Rail system with fasteners

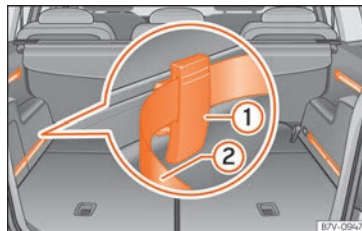


Fig. 146 In the luggage compartment: system including rails, adjustable attachment elements ① and adjustable tightening straps ②.

The rails and attachment system consists of four rails, movable attachment elements, straps to be secured to the rails and a net with supports to cover baggage » **page 146**. The rail and attachment system is designed to secure light objects. If the seats in the third row are to be occupied by passengers then attachment elements should never be placed in the section of the rails close to the seats » **⚠**.

Installing the attachment elements

- Fit the attachment element with the ruts facing upwards » **Fig. 146** ① to the upper part of the guide and press downwards.
- Move the attachment element to the desired position.

»

- Always ensure that the attachment inserts into the guide system »» » ⚠.

Removing the attachment elements

- Remove the attachment element from the guide and pull downwards.

Securing a load

- Pull the strap through the attachment element and secure the load »» » ⚠.

⚠ WARNING

In case of an accident or sudden braking, the attachment elements in the parts of the rails close to the seats of the third row could injure seat occupants.

- Whenever the seats on the third row are to be occupied, remove the attachment elements from the rails or move them all the way back.

⚠ WARNING

Movable attachment elements that are not secured correctly can be released from the guide in case of sudden braking or accident. As a result, objects may be fired through the vehicle interior causing serious injury or death.

- Always ensure that the movable attachment elements are correctly inserted into the guides.

⚠ WARNING

Unsuitable or damaged ropes or straps may be released in case of sudden braking or an accident. As a result, objects may be fired through the vehicle interior causing serious injury or death.

- Always use the attachment straps of the rail and attachment system.
- Secure the attachment straps firmly to the attachment elements.
- Loose objects in the luggage compartment can suddenly slide and change the way the vehicle handles.
- Secure all objects, little and large.
- Never secure a child seat to the attachment elements.

⚠ CAUTION

The attachment elements placed on the rail system can be damaged when folding down seats from the third row or putting them back into position and these can also damage the seats themselves. Before folding down or repositioning the seats, remove the attachment elements and supports for the net from the rail system.

Net to cover the luggage

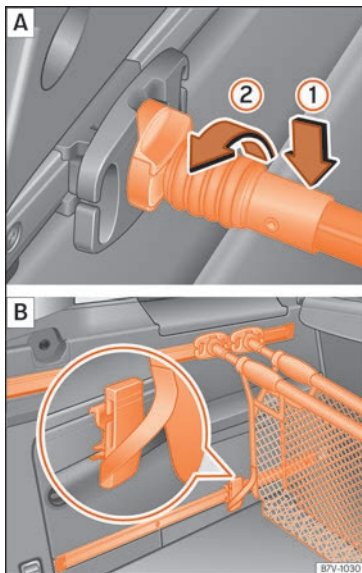


Fig. 147 Hook the baggage net A and use it as a bag B.

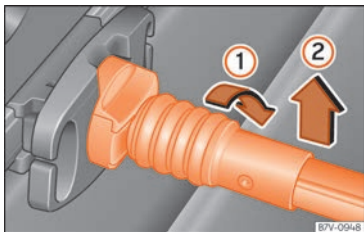


Fig. 148 Release the baggage net

If the seats in the third row are to be occupied by passengers then attachment elements should never be placed in the section of the rails close to the seats » » ⚠.

Installing the baggage net supports

- Fit the baggage net support into the guide from the back and press downwards.
- Move the baggage net support to the required position.
- Always ensure that the net support inserts into the rail system » » ⚠.

Hooking the baggage net into the support

Place the attachment rod on the baggage net support » » Fig. 147 ① and rotate 90° to the left ②. The red mark on the attachment rod should not be visible » » ⚠.

Using the net for bag type baggage

- Fit the baggage net supports to each one of the upper rails.
- Fit a movable baggage net attachment element to each one of the lower guides » » page 145.
- Hook the baggage net into the supports.
- Hook the baggage net attachment strap underneath into one of the movable attachment elements » » Fig. 147 B.
- Join the baggage net supports to the upper rails as much as possible by pushing them.
- Press the sides of the baggage net together so that they are held by the Velcro.

Using the baggage net to separate the luggage compartment

- Fit the baggage net supports to each one of the upper rails.
- Fit the baggage net supports to each one of the lower rails.
- Hook the baggage net into the supports.

To release the baggage net

- Rotate the attachment rod 90° to the right » » Fig. 148 ① until you can see the red mark on the rod. Pull the attachment rod upwards ②.

- **With only 5 seats:** after removing, place the baggage net safely in the front compartment on the floor of the boot » » page 152.

Removing the baggage net supports

- Remove the net attachment element from the rail and pull it out downwards.

⚠ WARNING

In case of an accident or sudden braking, the net attachment elements in the parts of the rails close to the seats of the third row could injure seat occupants.

- Whenever the seats on the third row are to be occupied, remove the attachment elements from the rails or move them all the way back.

⚠ WARNING

Baggage net supports that are not secured correctly can be released from the guide in case of the sudden braking or accident. As a result, objects may be fired through the vehicle interior causing serious injury or death.

- Always ensure that the baggage net supports are correctly inserted into the rails; the red mark should not be visible.
- Never secure a child seat to the baggage net supports. » »

ⓘ CAUTION

The baggage net supports placed on the rail system can be damaged when folding down seats from the third row or putting them back into position and these can also damage the seats themselves. Before folding down or repositioning the seats, remove the baggage net supports from the rail system.

Luggage net

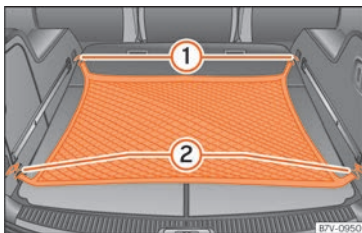


Fig. 149 In the luggage compartment: net for hanging luggage.

The baggage net can be used to secure lighter items.

Hooking the baggage net into the boot floor

- Hook the baggage net into the fastening rings »» Fig. 149 ① and ②.

Releasing the baggage net

The secured baggage net is taut »» ⚠.

- Carefully unhook the baggage net hooks from the fastening rings »» Fig. 149 ①.
- Carefully unhook the baggage net hooks from the fastening rings »» Fig. 149 ②.

⚠ WARNING

The elastic baggage net stretches when it is secured to the luggage compartment fastening rings. The secured baggage net is taut. The hooks on the net can cause injury if the net is incorrectly hooked or unhooked.

- Always ensure that the hooks do not suddenly release from the fastening rings when hooking or un-hooking.
- Always keep your face and eyes protected at a safe distance to avoid injury should a hook slip while hooking or unhooking.
- Always engage the hooks in the order given. If a baggage net hook springs back this can cause injury.

Bag hooks

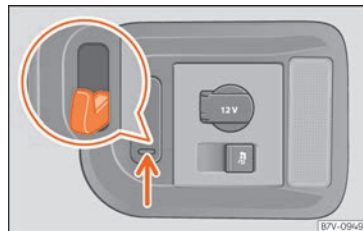


Fig. 150 In the luggage compartment: bag hooks.

On the right hand side of the luggage compartment there are some fold-out hooks for hanging bags »» Fig. 150.

- Press the retaining hooks down »» Fig. 150 (arrow) and fold them.

After use, raise the hooks again.

The retaining hooks have been designed to secure light shopping bags.

⚠ WARNING

Never use the hooks to hang luggage or other objects. In case of sudden braking or an accident, the hooks could break.

Net partition

Unfolding and folding the net partition

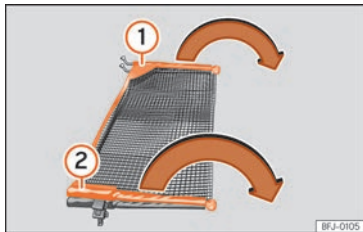


Fig. 151 Deploying the net partition.

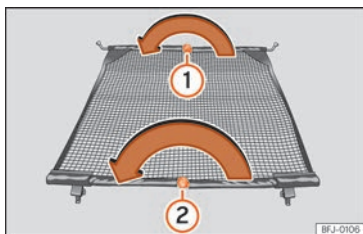


Fig. 152 Folding in the net partition.

Before fitting the net partition in the vehicle it must be unfolded.

Fold out the net partition

Take out the partition net from the corresponding bag and unroll it.

Extend the cross rods » **Fig. 151** ① and ② of the net in the direction of the arrows until it "clicks".

Folding in the net partition

- Press on the release button » **Fig. 152** ① and bend the cross rod in the direction of the arrow with the button pressed.
- Press on the release button » **Fig. 152** ② and bend the cross rod in the direction of the arrow with the button pressed.
- Fold in the net partition and store it in its bag.
- Store the net partition safely in the vehicle.

Using the net partition

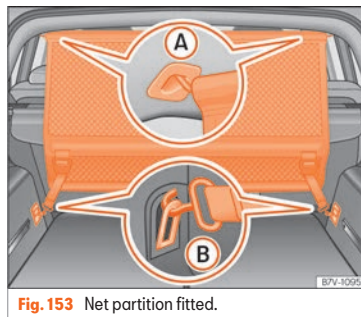


Fig. 153 Net partition fitted.

The purpose of the net partition is to prevent the items in the boot from moving into the cabin, e.g. in the event of sudden braking.

Fitting the net partition

The partition net can be fitted behind the rear seat or, depending on the features, behind the front seats with the second row of seats lowered.

- If required, remove the rear shelf » **page 141**.
- Folding out the net partition » **page 149**.
- Secure the net partition in the left housing of the roof » **Fig. 153** A. Make sure to move the cross rod down beyond the upper position.

»

- Hook in the net partition on the rear right-hand side roof housing by pressing on the rod »» Fig. 153 (A).
- Secure two hooks of the partition net to the fastening rings of the boot »» Fig. 153 (B) and tighten the straps firmly.

Removing the net partition

- If required, remove the rear shelf »» page 141.
- Loosen the straps from the net partition.
- Release the net hooks from the fastening rings »» Fig. 153 (B).
- Unhook the net partition on the right-hand side roof support »» Fig. 153 (A) by pressing on the rod.
- Unhook the net partition from the left-hand side roof housing.
- Fold in the net partition »» page 149.
- If required, fit the rear shelf »» page 141.

WARNING

In order to ensure the proper functioning of the luggage restraint systems (backrests together with the net partition), place the second row of seats in their rearmost position to avoid the possibility of the load on top moving forward. Risk to vehicle occupants.

WARNING

During a sudden driving or braking manoeuvre, or in the event of an accident, objects could be flung through the interior and cause serious or fatal injuries.

- Check whether the cross rods are correctly engaged.
- Always secure objects, even when the net partition is properly assembled.
- There should be nobody behind the net partition when the vehicle is moving.

CAUTION

If the net partition is secured incorrectly or to incorrect points, this may damage the vehicle.

Roof carrier

Introduction

The vehicle roof has been designed to optimise aerodynamics. For this reason, cross bars or conventional roof carrier systems cannot be secured to the roof water drains.

As the roof water drains are integrated in the roof to reduce air resistance, only SEAT-approved cross bars and roof carrier systems can be used.

Cases in which cross bars and the roof carrier system should be disassembled.

- When they are not used.
- When the vehicle is washed in a car wash.
- When the vehicle height exceeds the maximum height, for example, in some garages.

WARNING

- Always secure the load properly using belts or retaining straps that are suitable and in a good condition.
- Bulky, heavy, long or flat loads have a negative effect on aerodynamics, the centre of gravity and driving performance.
- Avoid sudden braking and manoeuvres.
- Adapt your speed and driving style at all times to suit visibility, weather, road and traffic conditions.

CAUTION

- Remove the cross bars and the roof carrier system before entering a car wash.
- Vehicle height is increased by the installation of cross bars or a roof carrier system and the load secured on them. For this purpose, check that your vehicle's height does not surpass the headspace limit, for example, for underpasses or for entering garage doors.

- Cross bars, the roof carrier system and the load secured on them should not interfere with the roof aerial or hamper the path of the panoramic sun roof and the rear lid.
- On opening the rear lid make sure that it does not knock into the roof load.

For the sake of the environment

When cross bars and a roof carrier system are installed, the increased air resistance means that the vehicle uses more fuel.

Securing the crossbars and the roof carrier system

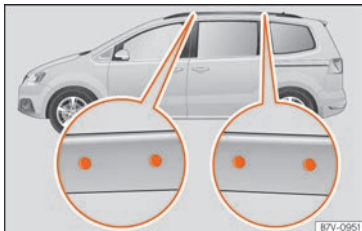


Fig. 154 Attachment points for the roof railings for the roof carrier system.

The crossbars are the basis of a series of special roof carrier systems. For safety reasons, special fixtures must be used to safely

transport luggage, bicycles, skis, surf boards or boats on the roof. Suitable accessories can be acquired at SEAT dealerships.

Always secure the crossbars and the roof carrier system properly. Always take the assembly instructions that come with the crossbars and the roof carrier system in question into account.

The attachment openings are located on the inner side of the side roof rods »» Fig. 154.

WARNING


Incorrect attachment and use of the crossbars and the roof carrier system may cause the whole system to detach from the roof and cause an accident and injuries.

- Always take the manufacturer assembly instructions into account.
- Check threaded joints and attachments travelling and if necessary tighten them after you have travelled a short distance. When making long trips, check the threaded joints whenever you stop for a rest.
- Do not modify or repair the crossbars or roof carrier system.


Note

Always read the assembly instructions that come with the crossbars and the roof carrier system carefully and keep them in the vehicle.

Loading the roof carrier system

The load can only be secured if the crossbars and the roof carrier system are properly installed »» .


Maximum authorised cargo on the roof

The maximum authorised cargo permitted for transporting on the roof is **100 kg (220 pounds)**. This figure comes from the combined weight of the roof carrier, the cross bars and the load itself on the roof »» .

Always check the weight of the roof carrier system, the cross bars and the weight of the load to be transported and weigh them if necessary. Never exceed the maximum authorised roof load.

If you are using cross bars and a roof carrier with a lower weight rating, you will not be able to carry the maximum authorised roof load. In this case, do not exceed the maximum weight limit for the roof carrier which is listed in the fitting instructions.

Distributing a load

Distribute loads uniformly and secure them correctly »» .

Check attachments

Once the cross bars and roof carrier system have been installed, check the bolted connections and attachments after a short

journey and subsequently with a certain frequency.

WARNING

- Never exceed the maximum authorised load on the roof and on the axles or the vehicle's maximum authorised weight.
- Never exceed the load capacity of the cross bars and the roof carrier system, even if the maximum authorised roof load has not been reached.
- Secure heavy items as far forward as possible and distribute the vehicle load uniformly.

WARNING

If the load is loose or not secured, it could fall from the roof carrier system or cause accidents and injuries.

- Always use belts or retaining straps that are suitable and in a good condition.

Storage compartment

Introduction

Use the storage compartments only for small or light items.

In the front centre armrest compartment the following factory-fitted connections are available: **USB/AUX-IN**.

The factory-fitted **CD changer** is located in the left-hand storage compartment of the luggage compartment.

WARNING

Objects inside the vehicle that are not secured could be thrown across the cabin in the event of sudden braking or manoeuvring. This may cause severe injuries as well as loss of control of the vehicle.

- Do not carry animals or sharp, hard or heavy items in open storage compartments of the vehicle, on the dashboard or on the cover behind the rear seats, or inside pieces of clothing or bags inside the vehicle.
- Keep the storage compartments closed at all times while the vehicle is in motion.

WARNING

Objects in the driver's footwell could difficult the use of the pedals. This may cause loss of control of the vehicle and increases the risk of severe injuries.

- Make sure that nothing prevents you from using the pedals at any time.
- Always secure the mat in the footwell.
- Never place other mats or other type of covers on the factory-fitted mat.

- Ensure that no objects can fall into the driver's footwell while the vehicle is in motion.

- When the vehicle is stationary, remove the objects in the footwell.

WARNING

If you leave lighters inside the vehicle, they might be damaged or lit inadvertently. This could lead to severe burns and damage to the vehicle.

- Before moving a seat, make sure there are no lighters in the moving part area of the vehicle.
- Before closing a storage compartment, make sure there are no lighters in the closing area.
- Never leave a lighter inside a storage compartment or any other surface of the vehicle as it could ignite due to the high temperatures on such surfaces, particularly during the summer.

CAUTION

- Do not store heat- or cold-sensitive objects, food or medicines in the cabin. Heat and cold could damage them or render them useless.
- Objects made from transparent materials left inside the vehicle, such as glasses, magnifying glasses or transparent suction

pads stuck to the windows can concentrate sunlight and damage the vehicle.

Glove compartment



Fig. 155 On the front passenger side: glove compartment.

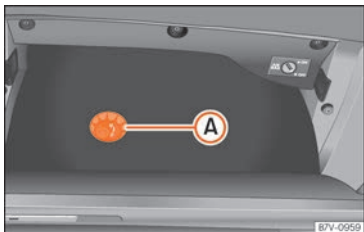


Fig. 156 On the front passenger side: glove compartment open.

Opening and closing the glove compartment

Unlock the glove compartment where necessary. The glove compartment is locked when the key slot is vertical.

Opening: Pull the handle »» Fig. 155 and open the glove compartment.

Closing: Press the glove compartment upwards.

Glove compartment cooling

With the AC on, cool air can be directed towards the inside of the compartment. Turn the air vent to open and close it.

⚠ WARNING

If the glove compartment is left open, the risk of causing severe injuries in the event of an accident, sudden braking or manoeuvring increases.

- Always keep the glove compartment closed while the vehicle is in motion.

⚠ CAUTION

For structural reasons, some vehicle versions will have gaps behind the glove compartment (for instance, behind the compartment for on-board documentation) into which small objects may fall. This could lead to strange noises and damage to the

vehicle. You should therefore not keep very small objects in the glove compartment.

Storage compartment in the front central armrest



Fig. 157 In the front central armrest: storage compartment.

Opening: Given the case, press the unlock button and raise the centre armrest in the direction of the arrow »» Fig. 157.

Closing: Lower the armrest.

⚠ WARNING

The centre armrest may obstruct the driver's arm movements, which could cause an accident and severe injuries.

- Keep the storage compartments of the centre armrest closed at all times while the vehicle is in motion.

Storage compartment in the roof console (glasses case)



Fig. 158 On the roof console: object holder for glasses.

Opening: Press and release the button

»» **Fig. 158.**

Closing: Press the cover upwards until it clicks into place.

i Note

For the surveillance of the cabin to work correctly, the storage compartments must be closed when locking the vehicle
 »» page 95.

Storage compartment in the roof console

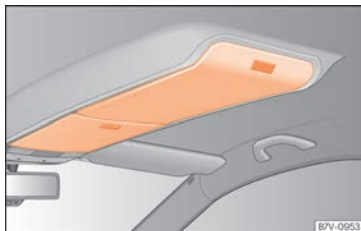


Fig. 159 On the roof console: storage compartment.

To open press the button and release it

»» **Fig. 159.**

To close, press the storage compartment upwards until it clicks into place.

To ensure interior monitoring works properly, the storage compartments must be closed when the vehicle is locked »» page 102.

Compartment in the instrument panel



Fig. 160 Storage compartment on the dash panel

The storage compartment on the instrument panel may have a cover.

To open, press the button on the cover

»» **Fig. 160** (arrow).

To close, press the cover down until it clicks into place.

Compartment in the front centre console.

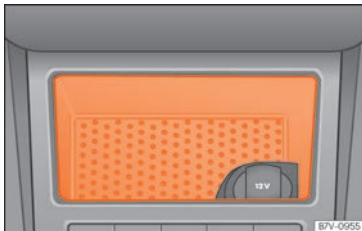


Fig. 161 Compartment in the front centre console.

There is an open compartment on the centre console »» **Fig. 161** in which there may be a 12 volt power socket »» page 158.

Card compartment

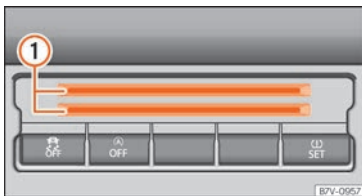


Fig. 162 Lower part of the centre console: card compartment.

To the bottom of the centre console there is a compartment »» **Fig. 162** ① for coins, cards, car park tickets and similar items.

i Note

To avoid theft or use by others, do not use the compartment to store credit or ATM cards or similar.

Folding table



Fig. 163 Folding table on the front seat

Depending on the model version, at the rear of the front seats, there may be "plane-style" folding tables for passengers in the rear seats.

- To open the tray, open it up in the direction of the arrow »» **Fig. 163**.
- To *fold it back*, push the folding table down as far as possible.

A drink holder is built into the folding table »» page 157.

⚠ WARNING

The table must always be closed while driving to decrease the risk of injuries.

Compartments in the rear footwell area

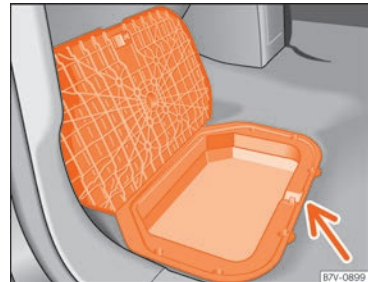


Fig. 164 Storage compartments in the footwell of the second row of seats.

Move the mat to one side (where applicable).

To *open*, pull on the rear centre part of the cover »» **Fig. 164** (arrow).

To *close*, press the cover down.

»

⚠ WARNING

Make sure children are properly belted in and correctly secured to avoid severe or fatal injuries while the vehicle is in motion.

- If you are using a child seat with a base or foot, always install this base or foot correctly and safely.
- If the vehicle has a storage compartment in the footwell in front of the last row of seats, this compartment cannot be used as designed; on the contrary, it must be filled using the specially designed accessory so that the base or foot is correctly supported by the closed compartment and the child seat is secured properly. If this compartment is not suitably secured when using a child seat with a base or foot then the compartment cover could rupture in an accident and the child will be ejected and suffer serious injury.
- Please read and observe the child seat manufacturer's handling instructions.

Object holder under front seats

Fig. 165 Drawer under the front seat

Opening: Press the tab on the drawer handle and take the drawer out.

Closing: Push the drawer under the seat until it engages.

⚠ WARNING

If the drawer is left open, it could prevent use of the pedals. This may cause serious accidents and injuries.

- Always keep the drawer closed while the vehicle is in motion. Otherwise, the drawer and any objects in it could fall into the driver's footwell and obstruct the pedals.

ⓘ CAUTION

The drawer can contain 1.5 kg at most.

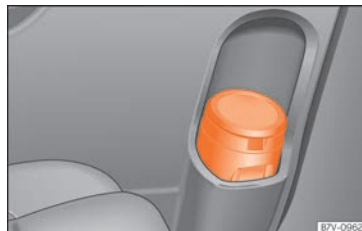
Portable rubbish bin

Fig. 166 Left sliding door trim: portable waste bin.

The portable waste bin fits onto the bottle holder on the trim of the left-hand sliding door.

⚠ WARNING

Do not use the portable waste bin as an ashtray to avoid the risk of fire.

Other storage compartments

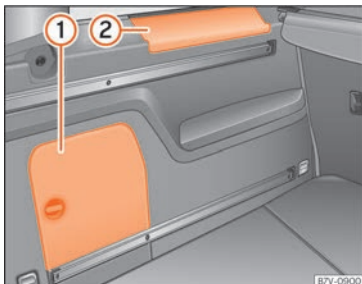


Fig. 167 In the luggage compartment: side storage compartment.

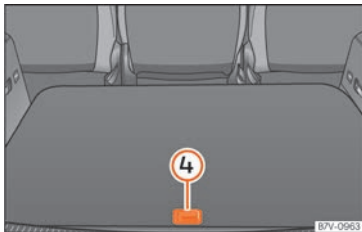


Fig. 168 Other compartments in the boot floor.

Side compartments in the luggage compartment

There are other compartments »» Fig. 167 ① and ② in the side of the boot. To open the

compartment ①, turn the catch clockwise. To open the compartment ②, lift the cover. The factory-fitted **CD changer** can be found in compartment ①. The shelf support covers can be safely stored in the luggage compartment cover ①.

Compartments in the boot floor

More storage compartments can be found in the boot floor.

- **Opening:** use the handle to lift the rear part of the luggage compartment floor »» Fig. 168 ④.
- To hold it open, fold out the hook from the rear right of the luggage compartment and hook the luggage compartment floor onto it »» page 141.
- **Closing:** fold the hook away and press down on the rear part of the luggage compartment floor ④

Other storage compartments:

- in the centre console, front and rear.
- in the door trims, front and rear.
- **Coat hooks** on the central door pillars and on the rear roof handles.
- **Bag hook** in the luggage compartment »» page 141.

⚠ WARNING

Clothing hung on the coat hooks could restrict the driver's view and lead to serious accidents.

- Hang the clothes from the hooks so that driver's view is not restricted.
- The coat hook is suitable for light items of clothing. Never place heavy, hard or sharp objects in the bags.

ⓘ CAUTION

Keep the CD changer compartment closed while the vehicle is in motion to reduce vibrations that could damage the changer.

📄 Note

The first aid kit is located in the rear left compartment of the luggage compartment.

Drink holder

Introduction

There are bottle holders in the storage compartments of the driver, front passenger door and sliding doors.

The folding tables of the front seats contain more bottle holders »» page 155.

»

⚠ WARNING

Incorrect use of the bottle holders may cause injuries.

- Never put hot drinks in the drink holders. In the event of sudden braking or an accident while driving, hot beverages in the bottle holders might spill and cause burns.
- Ensure that no bottles or other objects are dropped in the driver footwell while driving, as they could get under the pedals and obstruct their working.
- Never place glasses, food or other heavy objects drink holders. These heavy objects may be thrown across the cabin in the event of an accident and cause serious injuries.

⚠ WARNING

Closed bottles may explode inside the vehicle due to cold or heat.

- Never leave closed bottles in the vehicle if the temperature inside is very high or very low.

⚠ CAUTION

Do not leave open cans in the drink holders when the vehicle is in motion. If the drink is spilled (e.g. due to sudden braking) it may damage the vehicle and its electrical system.

i Note

The inside elements of the drink holders can be extracted for cleaning.

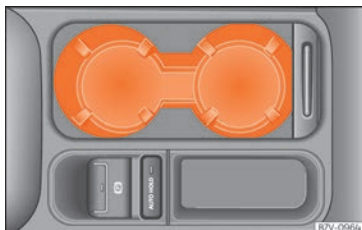
Front drink holders

Fig. 169 Front centre console: drinks holder.

- To open, move the cover backwards
»» **Fig. 169.**
- To close, move the cover forwards.

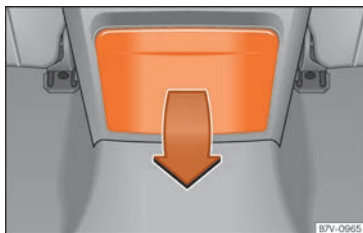
Rear drinks holder

Fig. 170 Back of the centre console: unfolding the drinks holders.

Opening: Folding the drinks holder
»» **Fig. 170.**

Closing: Lift the drinks holder.

The third row of seats has a drink holder in the side trim compartment on the rear left.

Power sockets**Introduction**

Electrical equipment can be connected to the power sockets in the vehicle.

All connected appliances should be in perfect working order without any faults.

⚠ WARNING

Improper use of the power sockets or electrical devices could lead to a fire and cause serious injuries.

- Never leave children unsupervised in the vehicle. The power sockets and equipment connected to them can be used when the ignition is switched on.
- Should a connected electrical device overheat, switch it off and unplug it immediately.

ⓘ CAUTION

- To avoid damage to the vehicle's electrical system, never connect equipment that generates electrical current, such as solar panels or battery chargers, to the 12 volt power sockets in order to charge the vehicle's battery.
- Only use accessories with approved electromagnetic compatibility according to current regulations.
- To avoid damage due to voltage variations, switch off all devices connected to the 12 V power sockets before switching the ignition on or off and before starting the engine.
- Never connect an appliance to the 12 volt power socket that consumes more than the power indicated in watts. Exceeding the maximum power absorption could damage the vehicle's electrical system.

🌿 For the sake of the environment

Do not leave the engine running when the vehicle is at a standstill.

📄 Note

- Using devices with the engine stopped and the ignition switched on will drain the battery.
- Unshielded equipment can cause interference on the radio equipment and the vehicle's electrical system.
- Interference can occur on the radio's AM waveband if electrical appliances are used near the rear window aerial.

Vehicle power sockets



Fig. 171 Back of the centre console: 12 volt power socket.



Fig. 172 Detailed view of the rear centre console: 230 volt European power socket.

Depending on your vehicle version, you may have a 12-volt power socket and/or a 230 volt power socket.

Maximum power consumption

Power socket	Maximum power consumption
12 Volts	120 Watts
230 Volts	150 watts (300 watt peaks)

Make sure that the maximum power consumption displayed on each outlet is not exceeded. The power consumption of devices is shown on the model plate.

When connecting two or more electrical devices at the same time, make sure that their total consumption never exceeds 190 watts

» ⓘ

»

12 volt power socket

The 12 volt power socket will only work with the ignition on.

Using electrical appliances with the engine stopped and the ignition switched on will drain the battery. Therefore, electrical devices connected to the power socket can only be used when the engine is running.

To prevent voltage variations from causing damage, switch off the electrical consumer connected to the 12 volt power socket before switching the ignition on or off and before starting the engine.

12 volt power sockets can be found in the following locations in the vehicle:

- Compartment in the centre of the centre console.
- Compartment in the front centre console.
- Storage compartment in the front central armrest.
- Rear centre console »» Fig. 171.
- At the rear right of the luggage compartment.

230 volt power socket

The power socket »» Fig. 172 can only be used when the engine is running »» ⚠.

Connect an electrical device: Open the cover and insert the plug into the power socket

as far as possible to unlock the built-in child lock. The socket only supplies power once the child lock is unlocked.

LED on the power socket

Steady green light:	The childproof lock is unlocked. The socket is ready to operate.
Flashing red light:	There is an anomaly, e.g. disconnection due to a current surge or overheating.

Disconnection due to overheating

When the temperature exceeds a certain value, the 230 volt socket inverter is automatically disconnected. The disconnection prevents overheating when the power consumption of the connected devices is excessive or the ambient temperature is very high. The 230-volt power supply can be used once again after a cooling time. First unplug the connector of the connected device and then plug it back in again. This prevents the electrical device from being switched on again if this is not wanted.

⚠ WARNING

The electrical system is under high voltage!

- Do not spill liquids onto the socket.
- Do not plug adapters or extension cords into the 230 volt power socket. Otherwise, the integrated child lock will be unlocked and the power socket will operate.

- Do not insert conductive objects (a knitting needle, for example) into the 230 volt power socket.

ⓘ CAUTION

- Always follow the operating instructions for the appliances to be connected!
- Never exceed the maximum power rating as this could damage the vehicle's general electrical system.
- 12 volt power socket:
 - Only use accessories with approved electromagnetic compatibility according to current regulations.
 - Never power the socket.
- 230 volt power socket:
 - Do not leave devices or connectors that are too heavy (e.g. a transformer) hanging directly from the power socket.
 - Do not connect neon lamps.
 - Only connect devices to the socket if the device and socket voltage match.
 - The built-in overload disconnect function prevents any electrical devices that require a high start-up current from turning on. In this case, unplug the electrical device's power supply and re-try the connection after about 10 seconds.

Note

- Some appliances may not work properly when connected to the 230 volt sockets due to a lack of power [watts].
- The 230 Watt Euro power connector can be modified for 115 Watt appliances and vice versa. Consult a specialist shop for advice on accessories to adapt the connector. SEAT recommends taking your car in for technical service.

Air conditioning

Heating, ventilation and cooling

Introduction

Depending on the vehicle's equipment, several systems may have been fitted:

- The **manual air conditioning** and the **Climatronic** cool and dehumidify the air. They operate most effectively with the windows and the sunroof closed.

To switch a specific function on, press the appropriate button. Press the button again to switch off the function.

The LED on each control lights up to indicate that the respective function of a control has been switched on.

Dust and pollen filter

The dust and pollen filter with its activated charcoal cartridge serves as a barrier against impurities in the air taken into the vehicle interior.

The dust and pollen filter must be changed regularly so that air conditioner performance is not adversely affected.

If the filter loses efficiency prematurely due to use in areas with very high levels of air pollution, the filter must be changed more frequently than stated in the Service Schedule.

⚠ WARNING

Reduced visibility through the windows increases the risk of serious accidents.

- Always ensure that all windows are free of ice and snow, and that they are not fogged, so as to maintain good visibility of everything outside.
- Only drive when you have good visibility.
- Always ensure that you use the air conditioning, heater or rear window heating to maintain good visibility to the outside.
- Never leave the air recirculation on for a long period of time. If the cooling system is switched off and air recirculation mode switched on, the windows can mist over very quickly, considerably limiting visibility.
- Switch air recirculation mode off when it is not required.

⚠ WARNING

Stuffy or used air will increase fatigue and reduce driver concentration possibly resulting in a serious accident.

- Never leave the fresh air fan turned off or use the air recirculation for long periods of time; the air in the vehicle interior will not be refreshed.



ⓘ CAUTION

- To replace the pollen filter, always visit a service centre.
- Switch the climate control or air conditioner off if you think it may be broken. This will avoid additional damage. Have the climate control or air conditioning checked by a specialised workshop.
- Repairs to the climate control or air conditioning require specialist knowledge and special tools. SEAT recommends visiting a SEAT Official Service.

ⓘ Note

- When the cooling system is turned off, air coming from the outside will not be dried.

To prevent fogging of the windows, SEAT recommends leaving the cooling system (compressor) turned on. To do this, press the **A/C** button. The button lamp should light up.

- The maximum heat output required to defrost windows as quickly as possible is only available when the engine has reached its normal running temperature.
- Keep the air intake slots in front of the windscreen free of snow, ice and leaves to ensure heating and cooling are not impaired, and to prevent the windows from misting over.
- The air from the vents flows through the vehicle interior and is extracted by slots in the luggage compartment designed for this

purpose. Therefore, you should avoid obstructing these slots with any kind of object.

- Do not smoke while air recirculation mode is on, as smoke drawn into the air conditioning system leaves residue on the evaporator, producing a permanent unpleasant odour.
- It is advisable to turn on the air conditioning at least once a month, to lubricate the system gaskets and prevent leaks. If a decrease in the cooling capacity is detected, a Technical Service should be consulted to check the system.
- When the engine is under extreme strain, switch off the compressor for a moment.

Climatronic control

Fig. 173 In the centre console: Climatronic controls.

Some Climatronic controls may also be on the air conditioner control panel located in

the rear centre console. These controls are used to make the appropriate settings for the rear seats.

Automatic mode AUTO

Automatic adjustment of temperature, fan, and air distribution. Automatic mode is disabled when the ventilation is modified manually.

Cooling mode A/C

Press the button to switch on or off the cooling system.

Temperature ①/②

The temperature of the right and left sides can be adjusted separately using the adjusters. The selected temperature is shown on the display of the climate control panel.

Synchronisation: press button **SYNC** so that settings on the driver's side apply to the passenger side. Use the temperature regulator for the passenger side to set a different temperature.




Blower

The power of the fan is automatically adjusted.

The fan is also adjusted manually by turning the control.

Air distribution

The airflow adjusts automatically for comfort. It can also be manually distributed to the desired zone by pressing the corresponding button:

-  The airflow is directed towards the chest
-  The airflow is directed towards the footwell.
-  The airflow is directed at the windscreen.

Defrost/demist function MAX

The air drawn in from outside the vehicle is directed at the windscreen and air recirculation is automatically switched off. To defrost the windscreen more quickly, the air is dehumidified at temperatures over approximately +3°C [+38°F] and the fan runs at maximum output.

Residual heat REST

When the engine is still warm but the ignition switched off, the residual heat of the engine can be used to keep the vehicle interior warm. The function is disabled after 30 minutes or when the charge of the 12-volt battery is low.

Air conditioning settings for the rear seats REAR

The air conditioning settings for the rear seats can be changed using the front control pan-

el. Press the button again to switch the function off or do not touch any other button for around 10 seconds.

Auxiliary heating

» page 168.

Heated rear window

This only works when the engine is running and switches off automatically after a maximum of 10 minutes.

It should be switched off as soon as the glass is demisted. By saving electrical power you can also save fuel.

To avoid possible damage to the battery, an automatic temporary disconnection of this function is possible, coming back on when normal operating conditions are re-established.

Windscreen heating

It only works when the engine is running and switches off automatically after a few minutes.

Air recirculation

» page 166

Seat heating

» page 167

»

Switching off

Press button **OFF** or manually set the fan to 0.

Note

- Not all Climatronic buttons are operational in REAR mode.

- The **REAR** button is locked in defrost mode.

Manual air conditioning controls



Fig. 174 In the centre console: manual air conditioning controls.

Cooling mode A/C

Press the button to switch on or off the cooling system.

Temperature ①

Turn the control to adjust the temperature.

Blower

Turning the regulator ② sets the fan power.

At level 0 the fan and manual air conditioning are disconnected. Level 4 is the maximum.

Air distribution

Turning regulator ③ distributes the air to the desired zone:

- The airflow is directed towards the chest
- The airflow is directed towards the footwell.
- The airflow is directed towards the windscreen and the footwell area.

Defrost/demist function

When control ③ is in position the air flow is directed at the windscreen and air recirculation is disconnected automatically or not ac-

tivated. Increase the fan power to clear the windscreen of condensation as soon as possible. To dehumidify the air, the cooling system will automatically switch on.

Maximum cooling power MAX A/C

When the regulator is in position **MAX A/C** air recirculation and the cooling system connect automatically.

Heated rear window

This only works when the engine is running and switches off automatically after a maximum of 10 minutes.

It should be switched off as soon as the glass is demisted. By saving electrical power you can also save fuel.

To avoid possible damage to the battery, an automatic temporary disconnection of this function is possible, coming back on when normal operating conditions are re-established.

Auxiliary heating

»» page 168.

Air recirculation

»» page 166

Seat heating

»» page 167

Controls on the rear seats



Fig. 175 Centre console: details of the rear seat controls.

- Turn the control **A** to adjust the temperature.
- Turn control **B** to adjust the air flow.

Climate control usage instructions

The interior cooling system only works when the engine is running and fan is switched on.

Economic use of the air conditioning

When the air conditioning is switched on, the compressor consumes engine power and has influence on fuel consumption.

The air conditioner operates most effectively with the windows and the panoramic sliding sunroof closed. However, if the vehicle has

heated up after standing in the sun for some time, the air inside can be cooled more quickly by opening the windows and the panoramic sliding sunroof briefly.

Change the temperature unit (Climatronic)

The temperature indication can be changed from Celsius to Fahrenheit using the instrument panel menu of the infotainment system »» page 74.

The cooling system cannot be activated

If the air conditioning system cannot be switched on, this may be caused by the following:

- The engine is not running.
- The fan is switched off.
- The air conditioner fuse has blown.
- The outside temperature is lower than approximately +3°C (+38°F).
- The air conditioner compressor has been temporarily switched off because the engine coolant temperature is too high.
- Another fault in the vehicle. Have the air conditioner checked by a specialised workshop.

Special characteristics

If the humidity and temperature outside the vehicle are high, **condensation** can drip off »

the evaporator in the cooling system and form a pool underneath the vehicle. This is normal and does not indicate a leak!

Note

After starting the engine, any residual humidity in the air conditioner could mist over the windscreen. Switch on the defrost function as soon as possible to clear the windscreen of condensation.

Air vents

To ensure proper heating, cooling and ventilation in the vehicle interior, the air vents must remain open.

- Turn the corresponding thumbwheel in the required direction to open and close the air vents. When the thumbwheel is in the ► position, the corresponding air vent is closed.
- Change the air direction using the ventilation grille lever.

There are other additional, non-adjustable air vents in the dash panel, in the footwells and in the rear area of the passenger compartment.



Note

Food, medicine and other heat or cold sensitive objects should never be placed in front of the air outlets as they may be damaged or made unsuitable for use by the air.



Air recirculation

Air recirculation mode prevents the ambient air from entering the interior.

When the outside temperature is very high, selecting manual air recirculation mode for a short period refreshes the vehicle interior more quickly.

For safety reasons, air recirculation mode is switched off when the button **MAX**  is pressed or the air distributor is turned to .


Manual air recirculation mode

- *Manual air conditioning:* Press the button  on the control panel to connect or disconnect the manual air recirculation mode.
- *Climatronic:* Press the  button until its left LED lights up.

Climatronic automatic air recirculation mode

With the automatic air recirculation mode activated, the entry of fresh air into the cabin interior is enabled. If the system detects a high concentration of hazardous substances in the ambient air, air recirculation mode is switched on automatically. When the level of impurities drops to within a normal range, recirculation mode is switched off.


The system is unable to detect unpleasant smells.

- To activate the automatic air recirculation mode press the button  on the control panel until its right LED lights up.

The air recirculation will **not** connect automatically in versions without humidity sensor and in the following external conditions:

- The outside temperature is lower than +3°C (+38°F).
- The cooling system is switched off and the outside temperature is below +10°C (+50°F).
- The cooling system is switched off, the outside temperature is below +15°C (+59°F) and the windscreen wipers are switched on.

WARNING

Observe the safety warnings »  in Introduction on page 161.

- **If the cooling system is switched off and air recirculation mode switched on, the windows can mist over very quickly, considerably limiting visibility.**
- **Switch air recirculation mode off when it is not required.**

CAUTION

Do not smoke when air recirculation is switched on in vehicles with an air conditioner. The smoke taken in could lie on the cooling system vaporiser and on the activated charcoal cartridge of the dust and

pollen filter, leading to a permanently unpleasant smell.

Note







Climatronic: air recirculation mode is activated to prevent exhaust gas or unpleasant odours from entering the vehicle interior when it is in reverse and while the automatic windscreen wiper is working.

Seat heating

The seat cushions can be heated electrically when the ignition is switched on. The backrest is also heated in some versions.

With the engine on, the seat cushion and the seat backrest can be heated electrically.

Control seat heating

- Press buttons  or  on the control panel to turn on the seat heating as high as possible.
- Press buttons  or  repeatedly to adjust it to the required level.
- To turn off the seat heating, press button  or  repeatedly until no LEDs are lit.

Cases in which the heat seating should not be switched on

Do not switch the seat heating on if any of the following conditions are met:

- The seat is not occupied.
- The seat has a cover.
- A child seat has been installed on the seat.
- The seat cushion is wet or damp.
- The outdoor or indoor temperature is greater than +25°C (77°F).

WARNING

People who cannot perceive pain or temperature because of medications, paralysis or chronic diseases (e.g. diabetes) or have a limited perception of these, may suffer burns to the back, buttocks or legs when using seat heating.

- People with limited pain and temperature thresholds must never use seat heating.
- If an abnormality in the device's temperature control is detected, have it checked by a specialist workshop.

WARNING

If the fabric of the cushion is wet, this can adversely affect the operation of the seat heating, increasing the risk of burns.

- Make sure the seat cushion is dry prior to using the seat heater.

- Do not sit on the seat with clothing that is wet or damp.
- Do not leave clothing that is wet or damp on the seat.
- Do not spill liquid on the seat.

CAUTION

- To avoid damaging the heating elements of the seat heaters, please do not kneel on the seat or apply sharp pressure to a single point on the seat cushion or backrest.
- Liquids, sharp objects and insulating materials (e.g. covers or child seats) can damage the seat heating.
- In the event of smells, switch off the seat heating immediately and have it inspected by a specialised workshop.

For the sake of the environment

The seat heating should remain on only when needed. Otherwise, it is an unnecessary fuel waste.

Auxiliary heating (additional heating)

Introduction

The auxiliary heater runs on fuel from the vehicle's tank and can be used while you are driving and when the vehicle is stationary.

The auxiliary heater can be switched on using the fast heating button of the air conditioning controls, with the remote control or by previously programming a departure time in the auxiliary heater menu of the infotainment system.

In winter, with the auxiliary heater switched on, you can defog the windscreen and leave it free of ice and snow (if it is a thin layer) before you start driving.

If the outside temperature is very high, the vehicle interior can be ventilated with the engine off using the auxiliary heater.

⚠ WARNING

The auxiliary heater exhaust fumes contain carbon monoxide, an odourless and colourless toxic gas. Carbon monoxide can cause people to lose consciousness. It can also cause death.

- Never switch on the auxiliary heater or leave it running in enclosed spaces or areas with no ventilation.

- Never programme the auxiliary heater so that it switches itself on and is running in an enclosed space or an area with no ventilation.

⚠ WARNING

The components of the auxiliary heater are extremely hot and could cause a fire.

- Always park your vehicle so that no part of the exhaust system can come in contact with easily flammable materials that might be below the vehicle, such as dried grass.


⚠ CAUTION

Never place food, medicines or other temperature-sensitive objects close to the air vents. Food, medicines and other objects sensitive to heat or cold may be damaged or made unsuitable for use by the air coming from the vents.

Switching the auxiliary heater on and off

Connection



The independent heating can be connected in the following ways:

- Press the fast heating button on the air conditioning control panel  » page 162. The control lamp of the button will light up.

- Press button **ON** on the remote control » page 169.
- Automatically scheduling a departure time » page 170.

Disconnection

The independent heating can be switched off in the following ways:

- Press the fast heating button on the air conditioner's control panel . The control lamp on the button turns off.
- Press button **OFF** on the radio-operated remote control » page 169.
- Automatically at the scheduled departure time or after the programmed operating time has elapsed » page 170.
- Automatically when the control lamp  [fuel level indicator] lights up » page 311.
- Automatically when the 12-volt battery charge drops too low » page 325.

Things to note

Once switched off, the auxiliary heater will continue to operate for a short period of time in order to burn the fuel remaining in the system and also to expel the exhaust fumes.

Radio-operated remote control

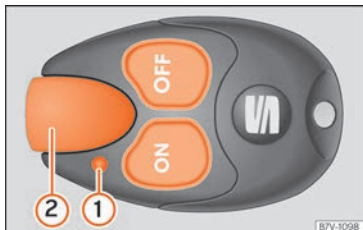


Fig. 176 Auxiliary heating: remote control.

Fig. 176

ON Switch the auxiliary heater on

OFF Switch the auxiliary heater off

① Control lamp

② Antenna

If the buttons of the remote control are pressed unnecessarily, it could switch on the auxiliary heater involuntarily, even when it is out of range or when the control lamp is flashing.

To switch on and off the independent heating, the button must be pressed and held for approximately 1 second.

Control lamp on the remote control

When the buttons are pressed, the control lamp on the remote control ① provides the user with different information:

It lights up for approx. 2 seconds

- *In green:* The auxiliary heater has been switched on using button **ON**.
- *In red:* The auxiliary heater has been switched off con with button **OFF**.

Flashes slowly for approx. 2 seconds

- *In green:* No on signal has been received. The remote control is out of range. Move closer to the vehicle.
- *In red:* No off signal has been received. The remote control is out of range. Move closer to the vehicle.

Flashes quickly approx. 2 seconds

- *In green:* The independent heating is blocked. Possible causes: the fuel tank is almost empty, the 12-volt battery charge is very low or there is a fault.

It lights up for approx. 2 seconds

- *In orange (then in green or in red):* The remote control battery is almost flat. However, the on or off signal has been received.
- *In orange (then flashes green or red):* The remote control battery is almost flat. No on or off signal has been received.

Flashes for around 5 seconds

- *In orange:* The remote control battery is flat. No on or off signal has been received.

Changing the battery of the radio-operated remote control

When pressing the buttons, if the control lamp of the remote ① flashes for approx. 5 orange or does not light up, the batteries must be replaced.

The battery is located beneath a cover on the back of the remote control.

- To open the cover, turn the slot to the left using a flat, blunt object (e.g. a coin).
- Remove the old battery.
- Insert the new battery. When doing so, take into account the polarity and use batteries of the same type » ①.

Range

The receiver is inside the vehicle. The remote control, when fitted with new batteries, has a range of several hundred metres. Obstacles between the remote control and the vehicle, bad weather conditions and discharged batteries can considerably reduce the range of the remote control.

⚠ WARNING

Swallowing a battery with a 20 mm diameter or any other button battery can cause serious and even fatal injuries within a very short time.

- Always keep the remote control, keyrings with batteries, the spare batteries, button »

batteries and all other batteries over 20 mm out of reach of children.

- If you suspect that someone may have swallowed a battery, seek immediate medical attention.

ⓘ CAUTION

- The radio frequency remote control contains electronic components. Therefore, avoid getting it wet and exposing it to knocks or direct sunlight.
- The use of inappropriate batteries may damage the radio frequency remote control. For this reason, always replace the used battery with another of the same voltage, size and specifications.

🌿 For the sake of the environment

- Please dispose of your used batteries correctly and with respect for the environment.
- The remote control battery may contain perchlorate. Observe the legal provisions regarding disposal.
- Care should be taken so as not to operate the remote control unintentionally so as to prevent the auxiliary heater being switched on accidentally.

Programming the auxiliary heater

Before programming it, check that the vehicle's date and time are set correctly .

Opening the Auxiliary heater menu on the instrument panel

- From the main menu, select the **Auxiliary heater** submenu and press the **OK/RESET** button on the wiper lever.
- **OR:** press the or buttons on the multifunction steering wheel until the **Auxiliary heater** menu is displayed.

Function button: function

Activate, Deactivate: The auxiliary heater can be set to come on automatically if required. Select a timer for this purpose:

- The timer will be marked with a .
- **Only one** timer can be selected at a time. If a timer has been selected, the screen will display **Program . ON**. If no timer has been selected, the instrument panel display will show **Prog. OFF**.
- To change a programmed timer you must either select a different timer or select **Deactivate**.

Timer 1 - 2 - 3: Three different timers (hh.mm) can later be selected using the **On** option. If the auxiliary heater is to be switched on for just a certain day of the week, select the day of the week and the time for the auxiliary heater to come on.

Function button: function

Duration: The operating time may vary between 10 and 60 minutes and can be set to 5-minute intervals.

Operating mode: Set to heat or ventilate the vehicle interior when the auxiliary heater is switched on.

Day: Set the current day of the week.

Factory settings: The predefined factory values for the functions of this menu are restored.

Back: This returns to the main menu.

Checking the programming

When a departure time is activated and the ignition is switched off the control lamp of the fast heating button lights up for approximately 10 seconds.

WARNING

Never programme the auxiliary heater so that it switches itself on and is running in an enclosed space or an area with no ventilation. The auxiliary heater exhaust fumes contain carbon monoxide, an odourless and colourless toxic gas. Carbon monoxide can cause people to lose consciousness. It can also cause death.

Usage instructions

The auxiliary heater exhaust system located below the vehicle must be kept clear of snow,

mud and other objects. The exhaust fumes must be able to exit freely. The emissions generated by the auxiliary heater are removed via an exhaust pipe fitted underneath the vehicle.


On heating the vehicle interior, depending on the outside temperature, the warm air is first directed at the windscreen and then to the rest of the vehicle interior through the air vents. Directing the diffusers – towards the windows for example – can affect air distribution.

Depending on the outside temperature, the temperature at which the auxiliary heater warms the vehicle interior may be somewhat higher if the heating or air conditioner temperature control is set to maximum before switching the heating on.

Depending on the engine, vehicles with auxiliary heater may be fitted with a second battery in the luggage compartment that is responsible for powering the auxiliary heater.

When the auxiliary heater is not switched on

- The auxiliary heater requires about as much power as the dipped beam headlights. If the 12-volt battery charge is too low, the auxiliary heater switches off automatically and cannot be switched on. This avoids problems when starting the engine.

- The heating must be activated every time you want to set off. Similarly, the departure time must reactivate each time.
- The control lamp  (fuel level indicator) lights up.

Note

- **Noises will be heard while the auxiliary heater is running.**
- **When the air humidity is high and the inside temperature low, condensation from the heating and ventilating system may evaporate when the auxiliary heater is switched on. In this case, steam may be released from underneath the vehicle. This does not mean that there is a vehicle malfunction.**
- **If the vehicle is tilted, e.g. if parked on a slope, the operation of the auxiliary heater may be restricted if the fuel tank level is low (just above the reserve level).**
- **If the auxiliary heater is used a number of times for a long period of time, the 12-volt battery will lose its charge. To recharge the battery, the vehicle must be driven for a number of kilometres from time to time. As a guideline: the journey should last approximately as long as the heater was connected.**
- **At temperatures below +5 °C (+41 °F), the auxiliary heater may switch itself on automatically when the engine is switched on. The auxiliary heater is switched off again after a certain time.**

Infotainment system

Introduction

Safety warnings

Safety warnings regarding the Infotainment system

Only operate the infotainment system and its various functions when the traffic situation really permits this.

WARNING

- Before starting the trip, you should familiarise yourself with the different infotainment system functions.
- High audio volume may represent a danger to you and to others. Hearing may be impaired if the volume is too high, even for short periods of time.
- Changes to the Infotainment system settings should be made when the car is stopped, or by a passenger.

WARNING

Current traffic requires maximum attention from public road users. Distracting the driver in any way can lead to an accident and cause injuries. Operating the Infotainment

system can distract your attention from the traffic.

- Always drive carefully and responsibly.
- Select volume settings that allow you to hear sounds from outside the vehicle at all times (e.g. emergency services sirens and horns).

WARNING

The volume level may suddenly change when you switch audio source or connect a new audio source.

- Lower the base volume before connecting or switching audio sources.

WARNING

The driving recommendations and traffic indications shown on the navigation system may differ from the current traffic situation.

- Traffic signs and traffic regulations have priority over the recommendations and displays provided by the navigation system.

WARNING

Connecting, inserting or removing a data medium while driving can distract your attention from the traffic and cause an accident.

WARNING

Place the connecting cables of external equipment so that they do not interfere with the driver's mobility.

WARNING

External devices that are loose or not properly secured could move around the passenger compartment during a sharp manoeuvre or accident.

- Avoid placing external devices on the doors, windscreen, steering wheel, dash panel, the backs of the seats, on top of or near the area marked "AIRBAG" or between these areas and the occupants. They could cause serious injury in an accident, especially when the airbags inflate.

WARNING

The armrest must always remain closed during the journey as it could restrict the driver's movements.

WARNING

Opening the CD or DVD player can lead to injuries from invisible laser radiation.

- Have CD players repaired only by a qualified workshop.

ⓘ CAUTION

The Infotainment system can be damaged by the incorrect insertion of a data storage device or the insertion of an incompatible data storage device.

- When inserting a data storage device, make sure it is correctly positioned.
- Applying force may irreparably damage the memory card slot locking mechanism.
- Only use compatible memory cards.
- When inserting and removing CDs, always hold them at right angles to the front of the CD drive without tilting so as not to scratch them.
- If a CD is inserted while another is already in the unit or being ejected, the CD drive may be damaged. Always wait until the data medium is completely ejected.

ⓘ CAUTION

Foreign objects stuck to a CD, or if it is not round, may damage the player.

- Only clean, standard 12-cm CDs should be used.
 - Do not affix stickers or other items to the data medium. Stickers may peel off and damage the drive.
 - Do not use printable data media. Printed labels and coverings may peel off and damage the CD drive.

- Do not insert 8-cm singles or irregularly shaped CDs.
- Do not insert DVD-Plus discs, Dual Discs or Flip Discs, as these are thicker than normal CDs.

ⓘ CAUTION

The vehicle loudspeakers may be damaged if the volume is too high or the sound is distorted.

ⓘ Note

For the proper functioning of the Infotainment system it is important that the date and time set in the vehicle are correct.

Overview of the unit

Media System Colour

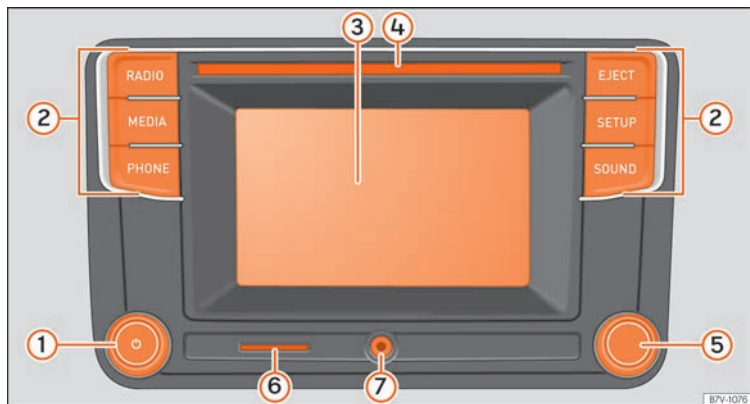


Fig. 177 Overview of the controls. The infotainment system is available in different versions that may have different titles and functions of some buttons.

- ① Volume. Off/on »» page 177
- ② Infotainment buttons:
 - **RADIO:** Radio Mode (change of band frequency) »» page 194.
 - **MEDIA:** Media mode (audio sources) »» page 203.
 - **EJECT:** Eject the CD »» page 203.
 - **PHONE:** Phone mode »» page 226.
- ③ Touchscreen »» page 178
- ④ CD drive »» page 203
- ⑤ Settings button (search and selection) »» page 177
- ⑥ Slot for memory cards »» page 210
- ⑦ AUX-IN multimedia socket »» page 212.
- **MUTE:** Mute the sound from the audio source.
- **SETUP:** Menu and system settings »» page 180.
- **SOUND:** Volume and sound settings »» page 181.

Media System Plus / Navi System

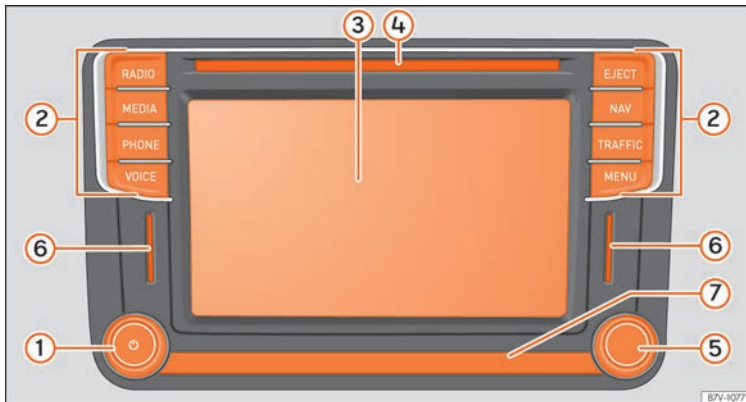


Fig. 178 Overview of the controls. The infotainment system is available in different versions that may have different titles and functions of some buttons

- ① Volume. Off/on »» page 177
- ② Infotainment buttons:
 - **RADIO**: Radio Mode (change of band frequency) »» page 194.
 - **MEDIA**: Media mode (audio sources) »» page 203.
 - **PHONE**: Phone mode »» page 226.
 - **VOICE**: Voice control »» page 183.
 - **MUTE**: Mute the sound from the audio source.
 - **EJECT**: Eject the CD »» page 203.
- **NAV**: Navigation Mode »» page 215.
- **SETUP**: Menu and system settings »» page 180.
- **TRAFFIC**: Traffic reports »» page 222.
- **SOUND**: Volume and sound settings »» page 181.
- **MENU**: Selection from the main menu »» page 176.
- ③ Touchscreen »» page 178
- ④ CD drive »» page 203
- ⑤ Settings button (search and selection) »» page 177

- ⑥ Slots for memory cards »» page 210
- ⑦ Proximity sensor »» page 180

Main menus

These menus depend on the equipment in question.

Radio » page 194

RADIO main menu » page 194
 RDS radio data services » page 195
 Digital radio mode » page 196
 Memory buttons » page 197
 Save station logos » page 197
 Select, tune and save stations » page 198
 SCAN automatic playback » page 200
 TP traffic information » page 200
 Setup » page 201

Media » page 203

Data and file formats » page 204
 Playback order » page 205 » page 205
 Change the media source » page 207
 Change track » page 207
 Selecting a track from a track list » page 208
 Insert or remove a CD or DVD » page 209
 Memory card » page 210
 External data storage device connected to the USB port » page 211
 External audio source connected to the AUX-IN multi-media socket » page 212
 External audio source with Bluetooth® » page 212
 Images » page 213
 Setup » page 214

Navigation » page 215

New destination » page 216
 Route options » page 217 » page 218
 My destinations » page 218
 Special destinations (POI) » page 220
 View » page 221
 Split screen » page 221
 Map display » page 222
 Traffic bulletins and dynamic guide » page 222
 Import vCards » page 223
 Navigation with images » page 224
 Road signs » page 224
 Route guidance in Demo mode » page 224
 Setup » page 224

Traffic » page 222

Traffic information (TP) » page 200
 Traffic bulletins and dynamic guide » page 222

Telephone » page 226

Bluetooth® » page 227
 Tethering » page 228
 Function buttons » page 230
 Enter number » page 232
 Agenda » page 233
 Short messages (SMS) » page 235
 Call list » page 236
 Quick dial keys » page 237
 Setup » page 237

Sound » page 181

Full Link » page 186

Requirements » page 187
 Activation of Full Link » page 188
 MirrorLink® » page 191
 Apple CarPlay™ » page 189
 Android Auto™ » page 190
 Frequently Asked Questions » page 192

Images » page 213

Setup » page 180

General instructions for use

Introduction


If the setup is changed, this may change the display on the screen and the Infotainment system may behave in a manner different to that described in this manual.

i Note

- Just press a button or the screen to use the infotainment system's functions.
- The equipment's software depends on the market in question, so it is possible that not all of the function buttons or described functions are available. The equipment is not faulty if a function button is missing.
- Due to country-specific legislation, certain functions may not be available on the screen when the vehicle is travelling above a certain speed.
- Using a mobile telephone inside the vehicle may provoke noise in the speakers.
- Restrictions on the use of devices using Bluetooth® technology may apply in some countries. For further information, contact the local authorities.
- On vehicles with ParkPilot, the audio volume is automatically lowered when reverse gear is selected. The volume can be lowered in the menu **Sound > Volume**.

Rotary push buttons and infotainment buttons

Rotary/push buttons

The left rotary push button  is the on/off button if pressed and the volume knob if turned.

The right rotary pushbutton is the search button if turned and the selection button if pressed.

Infotainment buttons

The buttons on the unit are shown in this manual with the word "infotainment button" and their function within a rectangle, for example, the infotainment button **MENU**.

The Infotainment buttons are used by *pressing them or pressing and holding*.

Switching on and off

When turned on, the system it starts up with the volume at which it was turned off, as long as it does not exceed the preset maximum start-up volume »» page 181.

The unit will switch off automatically when the key is removed from the ignition or when the on/off button is pressed (depending on the equipment fitted or the vehicle). If the Infotainment system is switched on again, it will



switch off automatically after approximately 30 minutes (switch-off delay).



i Note

- The Infotainment system is a part of the vehicle. It cannot be used in any other vehicle.
- If the battery has been disconnected, the ignition must be activated before switching on the Infotainment system.

Changing the basic volume

Increasing or decreasing the volume or muting the sound

Raise the volume: turn the volume control  clockwise or move the left thumbwheel on the multifunction steering wheel upward .



Lower the volume: turn the volume control  clockwise or move the left thumbwheel on the multifunction steering wheel downward .


Changes in volume are indicated by a volume bar on the screen. The volume can be controlled using the steering wheel controls. In this case, the changes in volume are displayed on the instrument panel by a volume bar.

It is possible to preset certain volume settings and adjustments »» page 181.



Muting the Infotainment system sound

- Turn the volume control  anti-clockwise until it displays .
- **OR:** press the **MUTE**¹⁾ infotainment button.
- **OR:** press the left wheel of the multifunction steering wheel.

Playback is paused while in Media mode (except AUX). The screen displays .

Operation of the function buttons and the instructions on the screen

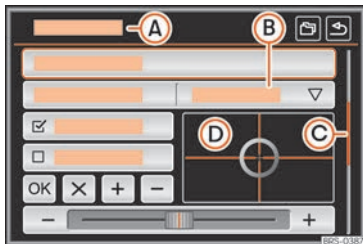
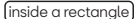



Fig. 179 View of some of the function buttons on the screen.

Active areas of the touchscreen that call up a certain function are called “function buttons”.

These buttons are operated by *pressing them* on the screen or *holding them down*.

The function buttons appear in this manual as a “function button” and a button symbol  inside a rectangle.

These activate functions or open submenus. The currently selected menu is displayed in the title bar  **Fig. 179** (A) of the submenus.

Inactive (grey) function buttons cannot be selected.

Increase or decrease the size of the images displayed on the screen


The size of the navigation map image and image views can be enlarged or reduced. To do this, slide 2 fingers across the screen to separate them or bring them together.

Overview of screen and function buttons

Display and function buttons: operation and effect

- (A) The title bar shows the selected menu and other function buttons.
- (B) Press it to open another menu.

Display and function buttons: operation and effect


- (C) The scroll bar is shown on the right. Scroll the bar by sliding your finger vertically on it  page 179, Open list entries and search in lists.


Movable cursor: Move the cursor by sliding your finger across the screen.


OR: Press a point on the screen where you want the sound to be directed.

- (D) **Fixed crosshair:** Press on the arrows to move the sound around according to your preferences.

OR: Press the central button to centre the stereo sound in the centre of the passenger compartment

-  Press it on some lists to move up a level, one by one.

-  Button to return to the previous menu or move up through the folder structure.

-  When pressed, a pop-up window opens (options window) which displays other setup options.

- / Some functions are activated or deactivated by pressing this box.

- OK** Press to confirm an entry or a selection.

¹⁾ Depends on the device.

Display and function buttons: operation and effect

x	Press to close a pop-up window or an input window.
+ / -	Press them to change the setup adjustments one at a time.
☐	Move the scroll button across the screen by sliding your finger.

Open list entries and search in lists

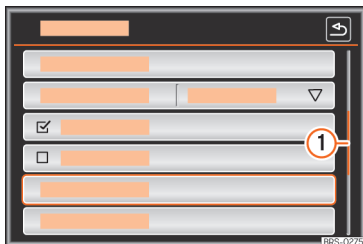


Fig. 180 Entries on a setup menu list.

The entries on a list can be activated by pressing them on the screen or by using the settings button.

Mark list entries using the setup button and open them

- Turn the adjustment knob to search and select from the list.
- Press the setup button to activate the marked entry on the list.

Search lists (scrolling the screen)

The scroll bar is shown on the right and its size depends on the entries in the list
 » Fig. 180 ①.

- On the bar: Press above or below the mark or slide your finger vertically over the mark until you reach the desired position.

Input window with on-screen keypad



Fig. 181 Text input in entry mask.

The on-screen keypad is used for functions such as entering a memory name, selecting a destination address or entering a search term for searching long lists.

The input line with cursor is located in the top bar of the screen. All inputs are displayed here.

Input windows for "free text input"

In the input masks for open text, you may enter letters, numbers and characters in any combination.

Input windows for selecting a saved entry (e.g. selection of a destination address)

It is only possible to enter a sequence of letters, numbers and characters that matches a stored entry.







Matches are suggested on the input line. In the case of compound names, it is necessary to enter a space.

Overview of the function buttons

Function button: operation and effect

- ① **Zip code^{pl}**: Press this button to enter a zip code in the Navigation mode.
- 123**: Press this button to open the number and special character input screen.
- ABC**: Press this button to go back to the letter input screen.


Function button: operation and effect

	Press this button to change the keypad language. Keypad languages can be selected from the menu system setup .
	Displays the number and opens the list of remaining selectable entries that match the entered text.
Letters and digits	Press them to copy them into the input line.
Letters with ✓	If the button is held down, special characters based on that letter are displayed. Press the desired character to enter it. Some special characters can be written out instead (e.g. "AE" for "Ä").
	Press this button to change between uppercase and lowercase.
	Space bar
OK	Press this button to confirm the suggested input and close the input screen.
	Deletes characters on the input line from right to left. Press and hold to delete several characters.
	Close the input window.

^{a1} Depends on the market and unit in question.

Proximity sensor

✓ Not available for model: Media System Colour

The Infotainment system is equipped with an integrated proximity sensor »» Fig. 178 .

The screen switches from display mode to automatic operation when your hand moves toward it. In operation mode, the function buttons are automatically highlighted to facilitate their use.

Additional information and display options

The displays appearing on the screen may vary depending on the settings, and may differ from those described here.

The status bar on the screen can display, for example, the current time and outside temperature.

All displays can be viewed only after completely restarting the Infotainment system.

Menu and system settings

The settings that can be selected varies depending on the country and the equipment in question, and on the vehicle's equipment.

- Press the infotainment button **MENU** and then press the **(Settings)** function button.
- **OR:** Press the infotainment **SETUP** button.

Press the function button of the main menu or the functions for which you want to change the settings. All settings are automatically applied when the menus are closed.

Function buttons

(Screen): To change the screen settings.

(Switch off screen (in 10 seconds)): If this function is active and the infotainment system is not used, the screen will automatically switch off after approx. 10 seconds. Pressing the screen or pressing one of the infotainment buttons will turn the screen on again.

(Brightness): To select the brightness level of the screen.

(Day / Night): To select the type of display (**Day**, **Night** or **Automatic**).

(Touchscreen tone): The confirmation tone when a function button is pressed is active.

(Proximity sensor): The proximity sensors are active. Also see »» page 180, **Proximity sensor**.

(Show clock in standby mode): In standby mode, the time is displayed on the infotainment system screen.

(Date and time): Change the time and date settings.

(Clock time source): To select the time source (GPS or manual).

Function buttons

GPS: The time and date can be selected using the **Time zone** function button. In this case, the **Time** and **Date** function buttons for manual entry will not be active.

Manual: The time and date can be set manually using the **Time** and **Date** function buttons.

Time: To set the time manually.

Time zone: To adjust the desired time zone.

Time format: To select the time display format (12 or 24 hours).

Date: To set the current date.

Date format: To select the date display format (**DD.MM.YYYY**, **YY-MM-DD** or **MM-DD-YY**).

Language: To select the desired language for texts and phrases in the voice control system.

Keyboard¹⁾: To select the type (alphabetical or keyboard).

Additional keypad languages¹⁾: To select additional keyboard languages.

Units: To set the units of measurement of the vehicle's displays: distance, speed, temperature, volume, consumption and pressure.

Data transfer for SEAT apps¹⁾

External apps: The mobile device app profile interface is active. Deactivating this function avoids other settings.

Function buttons

Operation via apps: Change the level of interaction with apps.

Deactivate: This limits specific functions that require a higher level of security.

Confirm: Allows 100% of functions of the app, and certain specific actions on the Infotainment system have to be confirmed.

Allow: Allows all available functions to be executed from the app.

Voice control: To change the voice control settings
» page 183.

Remove safely: To eject the data medium (SD/USB card) from the system. After correctly ejecting the data storage device from the system, the function button becomes inactive (grey colour).

Factory settings: When the original factory settings are restored, all **inputs and settings** that are made are **deleted**, depending on the selected settings.

Bluetooth: To change the Bluetooth® settings
» page 238.

System information: Display of the system information (device number, hardware and software versions).

Update¹⁾: To update the navigation data, do » page 215 **No** remove the memory card while the navigation data are being installed.

Copyright: Information about copyright.

¹⁾ This depends on the country and unit in question.

Note

For the proper functioning of the Infotainment system it is important that the date and time set in the vehicle are correct.

Volume and sound settings

The settings that can be selected varies depending on the country and the equipment in question, and on the vehicle's equipment.

- Press the infotainment button **MENU** followed by the **Sound** function button.
- **OR**: Press the infotainment button **SOUND**¹⁾.
- Press the main menu function button for the settings that have to be changed. All settings are applied instantly.

Overview of screen and function buttons

Function buttons

Volume: To change the volume settings.

Warnings¹⁾: To set the playback volume of warnings, such as traffic announcements.

Navigation announcements¹⁾: To set the playback volume of audio driving recommendations.

Voice control¹⁾: To set the playback volume of voice control.

¹⁾ Depends on the equipment in question

Function buttons

Maximum switch-on volume: To set the equipment's maximum switch-on volume.

Speed-dependent volume adjustment (GALA): To set the extent to which the volume is adjusted depending on the speed. The volume of the audio will increase automatically as the speed of the vehicle increases.

Volume: To set the playback volume of audio sources connected via the AUX-IN multimedia jack (**Low**, **Medium** or **High**). Also see

» page 181, Overview of screen and function buttons.

Bluetooth audio: To set the playback volume of audio sources connected by Bluetooth® (to **Low**, **Medium** or **High**). Also see » page 181, Overview of screen and function buttons.

Equaliser^{b1}: To adjust the sound properties.

Balance - Fader^{b1}: To adjust the sound distribution. The cursor indicates the current sound distribution in the passenger compartment. To modify the sound distribution, briefly press on the desired position in the passenger compartment view or use the arrow keys for a step-by-step modification. To centre sound distribution in the passenger compartment view, press the central function button located between the arrows.

Subwoofer: Adjusts the volume of the subwoofer.

Function buttons

Touchscreen tone: The confirmation tone when a function button is pressed is active.

Disabling voice navigation during calls^{a1}: During a telephone conversation, audio driving recommendations will not be given.

Dynaudio sound properties^{b1}: To select or adjust the sound properties.

Individual: Individual adjustment of sound properties.

Profile: To adjust the sound properties by selecting one of the 4 preset sound profiles (**Authentic**, **Soft**, **Dynamic** or **Speech**).

Dynaudio sound focus^{b1}: To adjust the sound distribution (Balance - Fader).

Individual: To adjust the sound distribution. The crosshair indicates the current distribution of sound in the passenger compartment. To modify the sound distribution, briefly press on the desired position in the passenger compartment view or use the arrow keys for a step-by-step modification. To centre sound distribution in the passenger compartment view, press the function button located between the arrows.

Function buttons

Profile: 4 preset sound distributions can be selected, which are optimized for the indicated positions (**Front left**, **Front right**, **Rear**) or **Front and Rear**). Select the desired sound distribution by pressing it.

^{a1} This depends on the country and unit in question.

^{b1} The function is not available in equipment with Dynaudio. The corresponding settings will be changed in the Dynaudio menus.

Adjust the playback volume of external audio sources

If you need to increase the playback volume for the external audio source, first lower the base volume on the infotainment system.

If the sound from the connected audio source is **very low**, increase the **output volume** on the external audio source. If this is not enough, change the **input volume** to **medium** or **high**.

If the sound from the connected external audio source is **too loud or distorted**, lower the **output volume** on the external audio source. If this is not enough, change the **input volume** to **medium** or **low**.

Voice control

Introduction

✓ Not available for model: Media System Colour

The Navigation¹⁾, Telephone, Radio and Media menu functions, can be activated by giving the corresponding commands (voice commands).

Instructions are given during voice control to facilitate the operation. These instructions will be given as a long or short dialogue, depending on the settings » page 185.

Available languages

Voice control is available for most languages that can be set in the infotainment system.

If voice control is not available for the language you wish to set, a message is displayed on the screen when you try to activate it.

Voice control will be used in the set language of the infotainment system.


• Set the desired language in the **System Settings** menu » page 180.

Note

Voice control is not available during a telephone call. Incoming calls interrupt voice control.

Tips for voice control

To use voice control correctly, keep the following in mind:

- Avoid external and background noise (such as conversations in the vehicle). Keep all windows, doors and the sunroof closed.
- **Do not** direct the air flow from the outlets towards the interior lining of the roof.
- Speak the commands when the audio and audio signals have finished playing, and the symbol  » Fig. 182 ① is displayed on the screen.
- If possible, speak clearly at a normal speed. If you pronounce words or figures confusingly or *mumble* syllables, the system will not be able to recognise them.
- Speak in a normal tone without stressing the words too much and avoid long pauses. **Do not** articulate or emphasize too much, or mumble, whisper or shout

- Speak a little louder if you are driving at high speed.
- Phone numbers can be spoken digit by digit or in blocks of 1-999.
- After a few commands, the voice control adapts to the speaker and recognises his/her commands better.

Using voice control

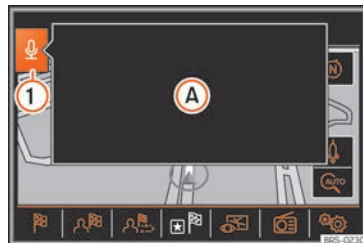



Fig. 182 Voice control: indication of the help menu elements that can be pronounced.

Switching on the speech control system


- To activate voice control, briefly press the infotainment button **VOICE** or button  on the multifunction steering wheel. »


¹⁾ This depends on the country and unit in question.

When voice control is activated, a rising audio signal is heard.

A help menu is displayed with the most important orders in the active mode at the time (e.g. Navigation) »» Fig. 182 (A). Other elements that can be spoken are shown in red on the corresponding screen »» Fig. 182. The help menu indication can be activated and deactivated in the **Voice control settings** menu »» page 185.

Speak commands

Speak the commands when the audio and audio signals have finished playing, and the symbol  1 is displayed on the screen.


- Say the desired command (e.g. “Start introduction”) to listen to the voice control introduction. See also »» page 184, **Introduction to voice control** and »» page 184, **Voice control help**.
- The system speech will guide you through the following dialogue.
- When an operation is completed, voice control ends with a downward audio signal.
- To interrupt a voice control phrase and say the next command directly, briefly press the infotainment button **VOICE** or button  on the multifunction steering wheel.

The displayed lists are numbered if voice control is active. The figures are shown on the left in the function buttons. Activate the de-

sired entry, e.g. figure 5, with the command “line 5”.

The “Back” command always takes you to the previous step of the dialogue.

Ending voice control


To end voice control, manually press and hold, or briefly press the **VOICE** button of the infotainment system twice (double click), or press button  on the multifunction steering wheel until the downward audio signal sounds.

Voice control also ends in the following circumstances:

- When a function button is pressed.
- When an infotainment button is pressed.
- When activating ParkPilot.
- With an incoming call.
- With the reception of a traffic announcement.

Introduction to voice control

We recommend listening to the introduction to voice control when you use it for the first time. The introduction is divided into sections that can be listed to in the set or, or by selecting them.


Briefly press the infotainment button **VOICE** or button  on the multifunction steering wheel.

Speak the command to start the introduction in the language set in the infotainment system and follow the instructions in the dialogue.

Language	Order
German	Einführung starten
English	Start tutorial
English (US)	Start introduction
Spanish	Iniciar introducción
French	Démarrer introduction
Portuguese	Iniciar introdução
Italian	Avvia introduzione
Czech	Zahájit úvod
Dutch	Snelcursus starten
Russian	Запустить программу обучения
Swedish	Starta introduktion
Turkish	Tanıtımı başlat
Polish	Rozpocznij wprowadzenie

Voice control help

The functions for which voice control is available have contextual help.

Select the function and briefly press infotainment button **VOICE**, or button  on the multi-function steering wheel.

Say one of the following commands, depending on the language set in the infotainment system.

Language	Order
German	Hilfe
English	Help
Spanish	Help
French	Aide
Portuguese	Ajuda
Italian	Aiuto
Czech	Nápověda
Dutch	Help
Russian	Справка
Swedish	Hjälp
Turkish	Yardım
Polish	Pomoc

Voice control settings

Open the **Voice control settings** menu

- Press the infotainment **VOICE** button.

- Press the **(SETTINGS)** function button.
- Then press the **(Voice control)** function button.

Function buttons

(Dialogue style): To select the style of the dialogue.


(Length): During voice control the phrases are longer and additional verbal indications may be given.

(Short): Some additional indications are removed from the long dialogue.



(Show possible commands): The help menu is displayed with the commands of the active function on the screen when voice control is activated.

(Voice control start tone): When voice control is activated, an upward confirmation audio signal is heard. Press to deactivate the audio signal.

(Voice control end tone): When voice control is deactivated, a downward confirmation audio signal is heard. Press to deactivate the audio signal.

(Dialogue input tone): In addition to the indication  a short acoustic signal is heard on the screen as soon as you can speak. Press to deactivate the audio signal.

Note

The volume of the voice control indications can be adjusted in the **Sound settings** menu  page 181 or during a speech using the **volume control** .

Connectivity

Full Link

Full Link technology description

✓ Not available for model: Media System Colour

The Full Link connection is made through a USB cable.

The Full Link system brings together technologies that allow communication between the Infotainment System and mobile devices:

- MirrorLink®
- Android Auto™
- Apple CarPlay™

Interfaces

To access the Full Link system, press the Infotainment button **MENU** (Full Link) and then select the **Full Link** context.

⚠ WARNING

Any applications that are not suitable or execute incorrectly may cause damage to the vehicle, accidents and serious injuries.

- SEAT recommends the use of the Apps that SEAT provides for this vehicle.
- To make full use of SEAT Apps, you must activate the **Settings > Data transfer for SEAT apps** option.

- The interaction level of the Apps on the system must be: **At Low**.
- Protect the mobile terminal with its applications from improper use.
- Never make modifications to the applications.
- Consult the instruction manual for the mobile terminal.

⚠ WARNING

The use of applications while driving can distract your attention from the traffic. Distracting the driver in any way can lead to an accident and cause injuries.

- Always drive carefully and responsibly.

⚠ CAUTION

- In areas where special regulations apply or the use of mobiles forbidden, it must be switched off at all times. The radiation produced by the mobile when switched on may interfere with sensitive technical and medical equipment, possibly resulting in malfunction or damage to the equipment.
- SEAT cannot be held liable for any damage caused to the vehicle as a result of the use of applications that are of poor quality or are defective, the inadequate programming of the applications, the insufficient coverage of the network, the loss of data during transmission or the improper use of mobiles.

📘 Note

- The use of Full Link technology could increase the amount you pay for data.
- SEAT recommends having a high battery charge on the device when connected to Full Link.
- SEAT recommends that to use Full Link, the "Date and time" should be correctly configured. Select **Settings > Date and Time**.
- SEAT apps are designed to communicate with the vehicle and interact with it through the Full Link connection.
- You can find further information on the technical requirements, compatible devices, suitable applications and availability at www.seat.com or at SEAT dealers.

Is Full Link blocked?

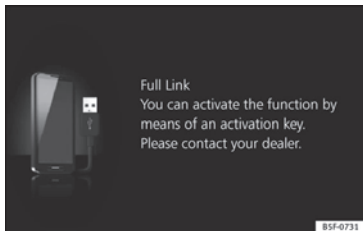


Fig. 183 Message on Infotainment system screen.

If your vehicle does not have Full Link, you can purchase it as an accessory at your SEAT dealer »» **Fig. 183.**

Requirements for Full Link

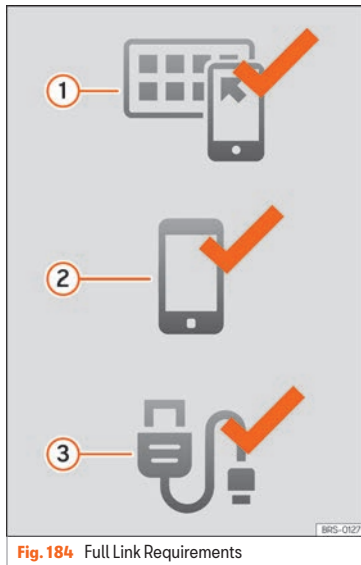


Fig. 184 Full Link Requirements

- ① **Full Link Activated:** If you do not have Full Link in your vehicle you can acquire it as an accessory at your Authorised Service.
- ② **Compatible Phones.** Go to the MirrorLink®, Android Auto™ or Apple CarPlay™

websites to confirm whether your phone is compatible with the system.

MirrorLink

- Check smartphone compatibility: www.mirrorlink.com/phones
- MirrorLink® 1.1 or later
- Some of the Apps certified by SEAT or the CCC must be installed in the device.

Android Auto

- Check smartphone compatibility. Android Auto™: www.android.com/auto/
- Android 6.0 or later
- Install Android Auto™ App for earlier versions of Android 10.

Apple CarPlay

- Check smartphone compatibility. Apple CarPlay™: www.apple.com/ios/carplay
- iPhone 5 or higher and iOS 7.1 or higher
- Turn on the SIRI personal assistant (see phone settings)

- ③ **USB cable connecting car to phone:** Use the approved USB cable supplied with the phone.

Activation of Full Link



Fig. 185 Centre front armrest: USB/AUX-IN input.

Data connection via Wi-Fi or SIM is not necessary to establish the connection between the smartphone and Full Link.

Data connection via Wi-Fi or SIM is necessary to enable all of the app features¹⁾.

Proceed as follows to use Full Link:

- Switch on the Infotainment system
- Connect the smartphone to the vehicle's USB port using a USB cable »» **Fig. 185**.
- On the main menu of the Full Link settings, select »» **page 192**:

- 1 Enable data transfer for SEAT apps.
- 2 Preferred connection type: Choose between MirrorLink™ or Android Auto™ only for Android™ phones compatible with both technologies. For iOS (Apple™) systems, the connection is automatic if the device is compatible.
- 3 Select the device.

Finally, a message will appear stating that data transfer will commence when the device is connected. Press **OK**. Once selected, the technology compatible with your device can be used.

i Note

Depending on your smartphone, it may have to be unlocked for the connection to occur.

What should I do if it does not connect?

Restart the mobile device.

Check the USB cable. Check whether the USB cable is damaged. Check that neither

connection (USB/micro USB) is damaged or worn.

Check that the USB ports are correctly connected. Check that the USB port of the vehicle and the device are not damaged and/or deteriorated.

- Clean the USB ports (device and vehicle).
- Try with another compatible mobile device.
- Have the USB port replaced at a SEAT authorised service.
- Have the mobile device repaired or replace it.

¹⁾ Using the data connection to transfer the smartphone apps to Full Link may involve additional charges. Please check the charges with your operator.

Full Link main menu



Fig. 186 Full Link main menu.

- 1 [List of devices]: display of connected devices.
- 2 [Disconnect]: disconnect active connection.
- 3 [Settings®]: Full Link settings.

Apple CarPlay™



Fig. 187 Apple CarPlay™ main menu

Apple CarPlay™ prior requirements

To use Apple CarPlay™ you must meet the following requirements:

- The mobile device **must** support Apple CarPlay™.
- The mobile device **must** be connected to the Infotainment system through USB.

Establish connection

If a mobile device is paired for the first time, follow the instructions on the Infotainment system display and the mobile device display.

- The prior requirements must be met in order to use Apple CarPlay™.

- Press the Infotainment **MENU** button and then select the [Full Link] context.
- Press the [Device list] »» Fig. 186 1 button and then select the mobile device from the list of devices.

End connection

- On the Apple CarPlay™ service press the »» Fig. 187 1 button to access the Full Link main menu.
- Press the »» Fig. 186 2 button to end the active connection.

Special characteristics

During an active Apple CarPlay™ connection, the following characteristics are applicable:

- Bluetooth connections between mobile devices and the Infotainment system are **not** possible.
- Any active Bluetooth connections are automatically terminated.
- Operating the phone is only possible through Apple CarPlay™. The functions described in these instructions for the Infotainment system are **not** available.
- The mobile device connected **cannot** be used as a media device on the Media menu. »

- It is **not** possible to use the built-in navigation system and the Apple CarPlay™ navigation system at the same time. The latest navigation system launched will terminate the previous one.
- The display of the instrument panel does not display any turning indications or notifications from the phone or other communication media.

Voice control system

- **Briefly** press **VOICE** or Ω to start the Infotainment system's voice control system.
- Press and **hold VOICE** or Ω to start the voice control system of the connected device.

Note

The information on technical requirements, compatible end devices, applications and availability are available on www.apple.com/ios/carplay or SEAT Authorised Services.

Android Auto™

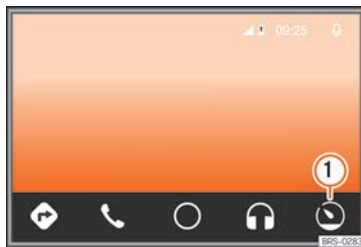


Fig. 188 Android Auto™ Menu

Android Auto™ Prior Requirements

To use Android Auto™ you must meet the following requirements:

- The Android Auto™ application **must** already be downloaded and installed on the mobile device.
- The mobile device **must** support Android Auto™.
- The mobile device **must** be connected to the Infotainment system through USB.

Initiating the connection

In order to initiate the connection with the mobile device, it is simply necessary to connect it to the Infotainment system via the USB connection, and to be sure to follow the instructions of the device being paired.

- Select the Android Auto™ connection type on **Full Link™ Settings**.
- The first connection to Android Auto™ must be done while the vehicle is stationary.
- Press the **Device list** **>>> Fig. 186 ①** button and then select the mobile device from the list of devices.
- If you are initiating the session using Android Auto™ technology via USB, the mobile telephone connects automatically via Bluetooth™ to the Infotainment system telephone and it will not be possible to pair another mobile telephone via Bluetooth™.

End connection

- On the Android Auto™ service press **>>> Fig. 188 ①**.
- Select **Return to SEAT** to access to the Full Link main menu.
- Press the **>>> Fig. 186 ②** button to end the active connection.

Special characteristics

During an active Android Auto™ connection, the following characteristics are applicable:

- Bluetooth connections between other mobile devices and the Infotainment system are **not** possible.
- Operating the phone is only possible through Android Auto™. If the Android Auto™

device is connected to the Infotainment system through Bluetooth at the same time, the telephone function of the Infotainment system can also be used.

- An active Android Auto™ device **cannot** be used as a media device on the Media menu.
- It is **not** possible to use the built-in navigation system and the Android Auto™ navigation system at the same time. The latest navigation system launched will terminate the previous one.
- The display of the instrument panel does not display any turning indications or notifications from the phone or other communication media.

Voice control system

- **Briefly** press **VOICE** or Ω to start the Infotainment system's voice control system.
- Press and **hold** **VOICE** or Ω to start the voice control system of the connected device.

Note

The information on technical requirements, compatible end devices, applications and availability are available on www.seat.com or SEAT Authorised Services.

MirrorLink™

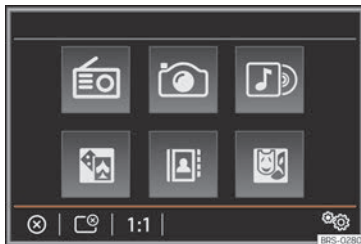


Fig. 189 Function buttons in the general view of compatible applications.

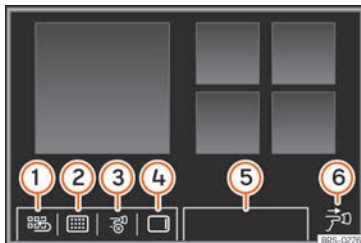


Fig. 190 Other MirrorLink™ function buttons.

MirrorLink™ prior requirements

In order to use MirrorLink™, the following requirements must be met:

- The mobile device **must** be compatible with MirrorLink™.

- The mobile device **must** be connected to the Infotainment system via USB.
- Depending on the mobile device used, a suitable application must be installed for the use of MirrorLink™ on the device.

Establish connection

The requirements must be met to use MirrorLink™.

- Press the **(MENU)** button on the Infotainment system.
- Press the **(Full Link)** button.
- Select the **(MirrorLink™)** connection type on **Full Link Settings**.
- Press the **(Device list) >>> Fig. 186 ①** button and then select the mobile device from the list of devices.


Function buttons and possible messages

Function buttons

Switching off	Terminating the MirrorLink™ connection.
	Press to close the open apps.
Close Apps	Then press the apps to be closed or the (Close all) function button to close all the open applications.
1:1	Press to change to the mobile device screen.

»


Function buttons

-  **Setup** To open the Full Link™ settings » table on page 192.
- ① Press to return to the main menu.
 - ② Press to show the Infotainment System on the display.
 - ③ Press to hide all function buttons.
OR: Press the right setting button to show or hide all function buttons.
 - ④ Press to display all the function buttons in the right-hand margin of the screen.
 - ⑤ View other function buttons.
The display of other function buttons and the number of buttons displayed depend on the mobile device used.
 - ⑥ The symbol refers to the right setting button.
Press the right setting button to show or hide all function buttons.




Full Link Settings

Full Link™ Settings

Open the menu Full Link Settings




- On the **Full Link** main menu, press the  function button.

Function buttons

-  **Select device**: Press to select the mobile device that will connect to the Infotainment system.
-  **Preferred connection type**: In devices that support MirrorLink™ and Android Auto™ technologies, you can select the default technology that you want to use to pair the mobile device to the Infotainment System.
-  **Activate data transfer for an app, SEAT**: Allows the exchange of information between the vehicle and external apps.

MirrorLink™ settings

Function buttons

-  **Screen orientation**: Allows the screen display orientation to be selected from one of the following types, on supported devices:
- Landscape
 - Portrait
-  **Rotated 180°**: It allows the image provided by the device to be rotated 180°.
-  **Prioritize keyboard of the Infotainment System**^{a)}: It allows the keyboard that is made available to the user to be the one in the Infotainment System before the one in the device itself.

^{a)} This function depends on the device that is used.

Frequently asked questions about Full Link

What connection method is used?

USB Cable.

Will the USB cable be supplied with the vehicle?

No. The USB cable supplied with the device should be used.

Is it possible to navigate?

Navigation is possible in each one of the Full Link technologies if the technology is available in your country and if you have the Navigation app.

What is the difference between using the Full Link system navigator (via a device) instead of another navigator?

Advantages: Daily updates.
Issues: data consumption, reception problems.

Can I send voice messages?

With certified applications, you can reply, not send.

What applications will be visible while driving?

Depending on the technology:

- for MirrorLink®: Apps certified by SEAT and the CCC,
- for Android Auto™: Apps selected by Google™,
- for Apple CarPlay™: Apps selected by Apple™.

Where can I find compatible Apps?

Compatible apps are listed at the following links:
www.mirrorlink.com/
www.android.com/auto/
www.apple.com/ios/carplay/

Where can I download the apps?

On Google Play™ for Android Auto™/MirrorLink® and on Apple Store™ for Apple CarPlay™.

If Full Link stops working, where can I go to repair it?

If the problem is in the car, you should go to the dealer. If the problem is in the mobile device, you should see your mobile telephone vendor.

Will WhatsApp be certified?

The WhatsApp situation depends on the technology.

Is MirrorLink® available in my country?

Yes, MirrorLink® is available in all countries and regions where SEAT is located.

What are the differences between MirrorLink®, Android Auto™ and Apple CarPlay™?

MirrorLink® is not compatible with Android Auto™ and Apple CarPlay™, as they are different technologies. They all coexist in Full Link, although Android Auto™ is designed for mobile devices with the Android™ operating system, and Apple CarPlay™ for iPhone.

Can MirrorLink® be installed in an older SEAT model?

No, it is not possible.

Where can I find more information about Full Link?

If you have any questions, please see our *Innovation/Connectivity* sections on our website: www.seat.es or www.seat.com or e-mail seat-re-sponde@seat.es

Operating modes

Radio

RADIO main menu



Fig. 191 RADIO main menu.

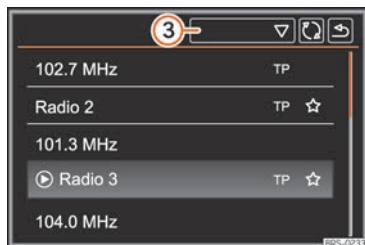


Fig. 192 Radio mode: station list.

Press the infotainment button **RADIO** to open the *Radio* main menu» Fig. 191.

RADIO main menu function buttons

Function buttons

① ^{a)}	To select the desired frequency band.
②	To change the preset key group using the function button.
	Sort the FM station list .
③ ^{a)}	<p>Alphabetically ▾: The station list is sorted alphabetically.</p> <p>Group ▾: The station list is sorted by station groups.</p>
☰ Stations	List of radio station that can be tuned.
📻 Manual	Selecting the frequency manually.
📡 View ^{b)}	Shows additional services. Only available in DAB mode.
⚙️ Setup	Settings menu for the current frequency band.
< / >	To change between stored stations or available stations.
	Adjustment of the arrow buttons in the menu.

Function buttons

SCAN	This function button is only available when automatic playback is on.
1 to 15 ^{c)}	Preset buttons to store stations » page 197.
🔄	To update the station list (frequency band AM or DAB).

- ^{a)} Not available for the Media System Colour model.
^{b)} This depends on the country and unit in question.
^{c)} The Media System Colour model has 12 memories.

Indications and possible icons

Display: Meaning

Ⓐ	Frequency or name of the station or radio text. The name of the radio station and the radio text will only be displayed if RDS is active.
RDS off ^{a)}	The RDS radio data service is deactivated.
TP ^{a)}	Traffic information can be retrieved: select Radio > Settings > Traffic programme (TP) .
No TP ^{a)}	No stations with traffic news are available.
☆	The radio station is stored on a memory button.

Display: Meaning

 a) DAB not available.

a) This depends on the country and unit in question.

Note

- Being underground, in tunnels, in areas with tall buildings or mountains can interfere with the radio reception.
- Foil or metal-coated stickers attached to the windows may affect reception on vehicles with a window aerial.
- Radio stations are responsible for the content of the information they transmit.

Radio data services RDS (FM band)



Fig. 193 RADIO main menu.

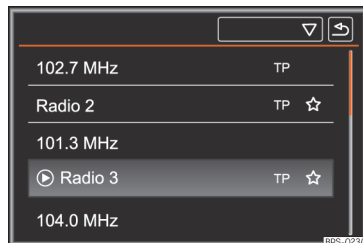


Fig. 194 Radio mode: station list (FM).

RDS (Radio Data System) is a radio data system that provides additional FM services such as the name of stations, automatic station tracking, radio text and traffic information (TP).

Depending on the country and the equipment in question, RDS can be deactivated in the **FM Settings** menu »» page 201.

In general, no **radio data services** are available **without RDS**.

Station name and automatic station tracking

If the RDS function is available, the names of the stations can be displayed on the **RADIO** main menu and on the **Station list**.

FM stations temporarily or permanently broadcast different contents on different re-

gional frequencies under the same name (for example, Radio 3).

In general, automatic station tracking takes charge of switching to the frequency with the best reception of the station that is tuned at any given time, while driving. However, this may cause a regional broadcast to be interrupted.

Automatic frequency switching and automatic station tracking can be deactivated in **FM Settings** »» page 201.

Radio text

Some stations that have RDS transmit additional information in text, the so-called radio text.

The radio text is displayed in the upper half of the screen above the memory buttons »» **Fig. 191 A**.

The radio text display can be deactivated in the **Settings** »» page 201.

Digital radio mode (DAB, DAB + and DMB audio)

✓ Not valid in Japan, China, Mexico, Brazil, Canada or the USA.



Fig. 195 DAB Radio mode main menu.

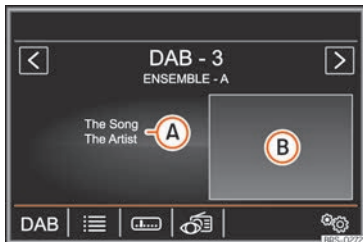


Fig. 196 Station information display in DAB radio mode.

The DAB radio tuner supports the DAB, DAB + and DMB audio transmission standards.

In Europe, digital radio is transmitted over band III frequencies (from 174 MHz to 240 MHz).

The frequencies are called “channels” and have an abbreviation (eg 12 A).

In a channel, several available DAB stations are grouped together in an “ensemble”.

Starting the Digital radio mode

- In the **RADIO** main menu, press the **>>> Fig. 195 ①** function button and select **(DAB)**.

The last DAB station that was selected will be played, if it can still be tuned in that location.

The selected DAB station is shown in the top bar of the **DAB-3** screen. The selected station ensemble is shown below **ENSEMBLE-A** **>>> Fig. 195.**

Additional DAB stations (Secondary Service Components)

Some DAB stations temporarily or permanently offer **additional stations** (for example, for the transmission of sporting events).

DAB stations containing additional stations are identified on the station list by the symbol ▶.


Select additional stations

Press the name of the main station on the DAB main menu to select an additional station. Or, select the additional station from the station list.

On the DAB main menu, the name of the additional tuned station is displayed next to the abbreviated name of the main DAB station.

Additional stations can not be saved.

Automatic station tracking

DAB radio is not currently available everywhere. DAB radio mode displays the areas without DAB coverage .

For automatic station tracking, a change to the FM frequency band can be allowed in the **DAB settings >>> page 202.**

If the DAB station being listened to can no longer be tuned in (e.g., there is no DAB coverage), the infotainment system tries to find and tune the same station on the FM frequency band.

For a station to be tracked on all frequencies, the DAB and FM station need to be broadcasting the same identification.

OR: DAB indicates which FM station corresponds to the DAB station, and the FM station in question can be tuned without any problems.

When the corresponding FM station has been found, **(FM)** is displayed behind the name of the station. If the corresponding DAB station becomes available again, it returns to DAB mode after a while. The **(FM)** indication disappears.

If the signal is too weak and the DAB station in question cannot be found again in the FM band, the radio sound is muted.

Screen Menu

The function buttons refer to the menu that is displayed when the **(View)** button is pressed »» Fig. 195.

Function buttons

(Preset list): Viewing the preset buttons »» Fig. 195.

(Station List): Simultaneous display of radio text and slideshows instead of memory keys »» Fig. 196.

(Radio text): The radio text is displayed instead of the memory buttons.

(Slideshow): Slideshows are shown in full screen mode.

Some DAB stations also offer an image "slideshow". Through this slideshow the stations can transmit information to the infotainment system in the form of digital images.

When a station is switched it may take some time until the slideshow of the tuned DAB station is loaded in the background.

Note

Not all DAB stations broadcast radio text and slideshows.

Memory buttons



Fig. 197 RADIO main menu.

In the *Radio* main menu, you can store stations from all available frequency wavelengths on the numbered function buttons. These function buttons are called "memory buttons".

Storing the station on the memory buttons

See: Preset stations »» page 199.

Change the memory bank (screens)

- Move your finger over the screen from left to right or vice-versa.

- **OR:** Press one of the function buttons »» Fig. 197 ①

Selecting the station from the memory buttons

- Press the memory button corresponding to the desired station.

The stored stations can only be played by pressing the corresponding memory button provided it can be received at your current location.

Storing the station logo on the memory buttons

Saved stations can be assigned logos »» page 197.

Storing or deleting station logos on the preset buttons

✓ Not available for model: Media System Colour

Depending on the country and the equipment, station logos for the FM and DAB frequency bands are pre-installed in the infotainment system. If a station is stored in a preset button, the logo corresponding to the station can be displayed on the preset button, provided that the **(Automatic saving)** function is active in the advanced settings »» page 201, Settings (FM, AM, DAB). **(station logos)**. »»

Station logos can be manually assigned to stations that are stored on preset buttons, which will then be displayed on the preset buttons.

Images in standard formats (e.g. jpg, bmp or even png) with a maximum size of 400 x 240 pixels, may be used as station logos.

In some countries, station logos can be downloaded from the Internet through a link on the “SEAT Senderlogos” website (SEAT logos).

Copy the logos to a compatible data medium (e.g. a SD card or USB memory) to import them into the infotainment system.

Automatically saving station logos on the preset buttons (FM and DAB)

- Press the function button **Settings** and then **Station logos**.
- Press the **Advanced settings** function button.
- Activate the **Automatic storage (station logos)** by pressing .

Manually storing the station logos on the preset buttons

- Copy the logos to a compatible data medium (e.g. a SD card or USB memory) to import them into the infotainment system.
- Select the desired frequency band in the **RADIO** main menu.

- Press the function button **Settings** and then **Station logos**.
- Press the preset button to which a logo is to be assigned.
- Select the source in which the logo has been stored (e.g. **SD 1**).
- Select the logo. Repeat this process to assign other logos.
- Press the infotainment button **RADIO** to return to the **RADIO** main menu.

Deleting the station logos from the preset buttons

- Select the desired frequency band in the **RADIO** main menu.
- Press the function button **Settings** and then **Station logos**.
- Press the preset button from which the station logo is to be deleted.
- **OR:** Press the **Delete all** function button to erase the station logos of all the presets.

Selecting, tuning and saving a station



Fig. 198 RADIO main menu.

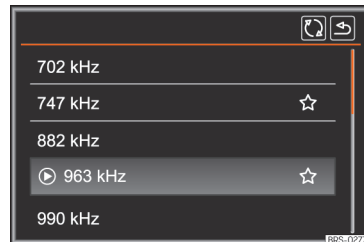





Fig. 199 Radio mode: station list (AM).

Selecting stations

Select the station using the arrow keys

Press the **Left Arrow** or **Right Arrow** **Fig. 198** function button.

Selecting stations

< / >	Depending on the setting of the arrow keys, you can switch between preset stations or tuneable stations. Setting the arrow buttons in the menu »» page 201, Settings (FM, AM, DAB), »» page 202, DAB settings.
Selecting stations from the station list	<p>To open the station list press the function  function button »» Fig. 198.</p> <p>OR: Turn the adjustment knob.</p> <p>Browse the list and tune to the station you want by pressing it.</p> <p>Press the  »» Fig. 199 function button to close the list. If it is not used, the list will close automatically after a while.</p>
Updating the station list	<p>The FM, AM and DAB frequency band station lists are updated automatically.</p> <p>In the AM and DAB frequency bands you can also update the station list manually by pressing the function button  »» Fig. 199.</p>


Manually tuning a station frequency

Display the frequency band	Press the  function button »» Fig. 198.
----------------------------	--------------------------------------------------------------------------------------------------------------------------

Manually tuning a station frequency

Changing the frequency step by step	<p>Turn the adjustment knob.</p> <p>OR: Press the arrow buttons to the right or to the left of the frequency band.</p>
Quickly track the frequency band	<p>Press one of the arrow buttons at the top of the screen »» Fig. 198. The next tuneable station is set automatically.</p> <p>OR: Press and hold one of the arrow buttons at the top of the screen »» Fig. 198.</p> <p>Once released, the system automatically switches to the next tuneable radio station. In DAB mode, it switches to the next tuneable ensemble.</p> <p>OR: Place your finger on the frequency band's scroll button and move your finger to move the button.</p>
Hide the frequency band	<p>Briefly press the settings button.</p> <p>Selecting a station with the preset button also ends the manual frequency selection. If no operations are performed, the frequency band is hidden after a while.</p>

Presetting stations

Store the current station on a preset button	<p>Press and hold the desired preset button »» Fig. 198 until an audible signal is heard.</p> <p>The tuned station will be stored on that pre-set button.</p>
Save a station from a stations list with a preset button	<p>Press the  »» Fig. 198 function button or turn the settings button to open the station list.</p> <p>The stations that are already stored on a preset button are marked on the station list with the symbol ☆ »» Fig. 199.</p> <p>Select the desired station by pressing and holding it down on the screen.</p> <p>Press the preset button on which the station in question is to be saved.</p> <p>A signal sounds and the station is saved on the preset button. Repeat the process to continue saving other station on the list.</p>
Delete preset stations	<p>All saved stations on the frequency band in question can be deleted one by one, or all at the same time »» page 201, Settings (FM, AM, DAB), »» page 202, DAB settings.</p>

Setting a station name (FM frequency band)

Some radio stations transmit very long names that are represented as plain text on the screen.

To set the text that is displayed at that moment, press and hold the name of the station until an audible signal is heard.

The set station names are displayed with dots to the left and right of the station name.

The set text is applied to all the preset buttons on which that radio station is saved.

Automatic playback (SCAN)



Fig. 200 Radio mode: automatic playback (SCAN) active.

When automatic playback is active, all tuneable stations in the selected frequency band are played for approximately 5 seconds each. (SCAN) >>> Fig. 200 is displayed on the screen.

Start automatic playback

- Briefly press the settings button.
- **OR:** Press the (Settings %) function button and then select (Scan).

End automatic playback

- Briefly press the settings button.
- **OR:** Press the (SCAN) function button to end automatic playback on the station that is being played.

Automatic playback also ends when a station is selected manually using the memory buttons.

TP function (traffic information station)



Fig. 201 RADIO main menu with the TP indication.

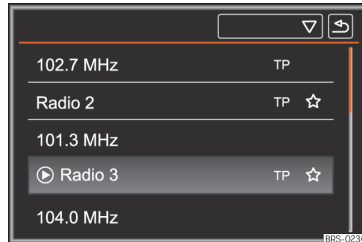


Fig. 202 List of stations with the TP indication.

The TP function (traffic information station) is not available on all equipment, in all places or on all FM stations.

Using the TP function to track traffic information is only possible if a station with traffic information can be tuned. Stations with the traffic information function are displayed on the **RADIO** main menu along with **TP**

»» **Fig. 201** and »» **Fig. 202**.

Some stations without their own traffic information support the TP function by broadcasting traffic announcement from other stations (EON).

Activating and deactivating the TP function

- Activate or deactivate the **Traffic information station (TP)** function button by pressing it »» **page 201**, **Settings (FM, AM, DAB)**, »» **page 202**, **DAB settings**.

If the station you are listening to **does not** have the TP function, **No TP** will be displayed on the upper part of the screen.

Active TP function and station selection

If traffic station tracking is active, the acronym **TP** is displayed on the top right of the screen in audio mode »» **Fig. 201**. The traffic bulletins of the station that is being listened to, or of the station that provides traffic information, are played in Audio mode.

In **FM mode**, the station that is **being listened to** must have the TP function. If after activating the TP function a station is selected using the preset buttons, or by tuning

manually, that **does not** have the TP function, the traffic information station will not be tracked (indication: **No TP**).

If it is not possible to continue tuning the current traffic station, **No TP** is also displayed and a manual station search will have to be started »» **page 198**.

In **AM mode** or in **Media mode**, a traffic station is automatically tuned in the background, as long as the station has a good signal. Depending on the situation this operation may take some time.

Incoming traffic announcement

In Audio mode, traffic announcements are played automatically when they are received.

While the traffic announcement is playing, a pop-up window is displayed and the radio changes, if necessary, to the traffic information station (EON).

Media mode is interrupted and the volume is set as adjusted »» **page 181**.

The traffic announcement volume can be changed with the volume control **Q**. The modified volume remains as set for subsequent bulletins.

- Press the **Interrupt** function button to stop playback of the traffic bulletin that is being listened to. The TP function remains active.
- **OR:** Press the **Deactivate** function button to stop the traffic announcement that is being played and to permanently disconnect the TP function.

Settings (FM, AM, DAB)

FM settings

Select the **FM** frequency band by pressing the Infotainment button **RADIO**.

OR: Press function button »» **Fig. 201** **1** and select the **FM** frequency band.

Press the **Settings** function button to open the **FM settings** menu.

Function buttons

Sound: Sound settings »» **page 181**.

Scan: Automatic playback [SCAN function]. When automatic playback is active, each of the tuneable stations in the selected frequency band are played for approximately 5 seconds each »» **page 200**.

Seek mode: To set the settings for the arrow buttons **◀** and **▶**. The setting applies to all frequency bands (FM, AM and DAB).

Preset list: The arrow keys are used to switch between all of the saved stations in the selected frequency band.

»

Function buttons

Station List: The arrow keys are used to switch between all of the tuneable stations in the selected frequency band.

Traffic programme (TP): The TP function (tracking of traffic information stations) is active **»» page 200**.

Delete presets: To erase all or some of the preset stations.

Station logos: To assign or delete manually the station logos saved in the memory keys **»» page 197**.

Radio text: The radio text is active **»» page 195, Radio text**.

Advanced settings^{a1}: Radio data services (RDS) settings.

Autostore station logos^{a1}: The stations saved on the memory buttons are automatically assigned radio station logos if they are available in the infotainment system. Also see **»» page 197**.

Station logo region^{a1}: This allows the vehicle's region (country) to be selected. This optimizes the automatic assignment of station logos. The option also allows the system to select the region automatically.

Automatic frequency control (AF)^{a1}: Automatic station tracking is active. When there is no check in check box , the function button **RDS regional** will be inactive (grey).

Radio data system (RDS)^{a1}: The Radio Data System (RDS) is deactivated **»» page 195**. If there is no check in check box , the traffic information station (TP), radio text, station name and program type functions will not be available.

Function buttons

RDS regional^{a1}: Set the RDS **automatic station tracking** **»» page 195**.

Fixed: Only alternative frequencies of the set station with an identical region program are set.

Automatic: It always changes to the frequency of the set station that has the best signal at the time, even if a regional broadcast that is in progress is interrupted.

^{a1} This depends on the country and unit in question.

AM settings

Select the **AM** frequency band by pressing the Infotainment button **RADIO**.

OR: Press function button **»» Fig. 201 ①** and select the **AM** frequency band.

Press the **Settings** function button to open the **AM settings** menu.

Function buttons

Sound: Sound settings **»» page 181**.

Scan: Automatic playback (SCAN function). When automatic playback is active, each of the tuneable stations in the selected frequency band are played for approximately 5 seconds each **»» page 200**.

Seek mode: To set the settings for the arrow buttons **K** and **M**. The setting applies to all frequency bands (FM, AM and DAB).

Function buttons

Preset list: The arrow keys are used to switch between all of the saved stations in the selected frequency band.

Station List: The arrow keys are used to switch between all of the tuneable stations in the selected frequency band.

Traffic programme (TP): The TP function (tracking of traffic information stations) is active **»» page 200**.

Delete presets: To erase all or some of the preset stations.

Station logos: To assign logos to stations stored on memory buttons **»» page 197**.

DAB settings

Select the **DAB** frequency band by pressing the Infotainment button **RADIO**.

OR: Press function button **»» Fig. 201 ①** and select the **DAB** frequency band.



Press the **Settings** function button to open the **DAB settings** menu.

Function buttons

Sound: Sound settings **»» page 181**.


Scan: Automatic playback (SCAN function). When automatic playback is active, each of the tuneable stations in the selected frequency band are played for approximately 5 seconds each **»» page 200**.

Function buttons

Seek mode: To set the settings for the arrow buttons  and . The setting applies to all frequency bands (FM, AM and DAB).


Preset list: The arrow keys are used to switch between all of the saved stations in the selected frequency band.

Station List: The arrow keys are used to switch between all of the tuneable stations in the selected frequency band.


Traffic programme (TP): The TP function (tracking of traffic information stations) is active  **page 200**.

Delete presets: To erase all or some of the preset stations.

Station logos: To assign logos to stations stored on memory buttons  **page 197**.

Radio text: The radio text is active  **page 195**, **Radio text**.

Advanced settings: DAB services settings.

Autostore station logos^{a)}: Station logos are assigned automatically when the radio stations are stored on the memory buttons  **page 197**.

DAB traffic announcements: DAB traffic announcements are played in the same way as TP traffic announcements in any equipment mode.

Function buttons

Other DAB announcements: DAB announcements (news, sports information, weather, warnings, etc.) are played while the DAB Radio mode is active.

DAB - DAB station tracking: Automatic station tracking within the DAB frequency range is active.

Automatic DAB - FM switching: Switching to the FM frequency band is permitted for automatic station tracking.

^{a)} This depends on the country and unit in question.

Media

Introduction

Audio or image sources containing files in different media are known as **"media sources"**. These audio files can be played through the corresponding players or the infotainment system's audio inputs.

Only supported files are displayed and played. Other files are ignored.

Copyright

Consider the legislation on the intellectual property of audio and video files.

Note





- **MPEG-4 HE-AAC audio coding technology and patents are licensed by Fraunhofer IIS.**
- **This product is protected by certain Microsoft Corporation copyright and property rights. The use or commercialization of technology of this type outside the configuration of this product, without a licence from Microsoft or an authorised Microsoft branch is prohibited.**
- **The infotainment system only plays compatible undamaged audio files; other files are ignored.**
- **Check the list of compatible devices on the SEAT website.**

Requirements for data media and files

The factory-fitted CD and DVD players are class 1 according to DIN IEC 76 (CO) 6 / VDE 0837.

Only standard 12 cm CD/DVDs and 32 mm x 24 mm x 2.1 mm or 1.4 mm memory cards can be inserted in the infotainment system.

Any playable file formats on the list will hereinafter be known as “audio files”. A CD containing these types of audio files is called an “audio data CD”.

Data media	Requirements for playing audio files
<p> Optical discs:</p> <ul style="list-style-type: none"> – Audio CD (up to 80 min). – CD-ROM, CD-R, CD-RW with audio data up to a max. of 700 MB (megabyte) with the ISO 9660 Level 1 and 2, Joliet or UDF 1.02, 1.5, 2.01 file system. <p> Memory cards:</p> <ul style="list-style-type: none"> – SD and MMC in the file system must be FAT12, FAT16, FAT32 or VFAT (max 2 GB). – SDHC (max 32 GB) and SDXC (max 2 TB) with the exFAT and NTFS file systems. <p> USB data media:</p> <ul style="list-style-type: none"> – Devices with USB 2.0 and 3.0 specifications. – FAT16, FAT32, exFAT and NTFS file system. – Different generations of iPods™^{a)}, iPads™^{a)} and iPhones™^{a)}. – MTP players with the trademarks “PlaysForSure” or “ReadyForVista”.. 	<ul style="list-style-type: none"> – Digital Audio Specification. – MP2 (.mp2) and MP3 (.mp3) files with transfer rates from 32 to 320 kbit/s or variable transfer rate. – WAV files (.wav). – WMA files (.wma) up to 10 mono / stereo without copy protection and transfer rates of up to 384kbit/s. – AAC files (.m4a, .m4b and .aac) without copy protection. – OGG-Vorbis 1 (.ogg) files with transfer rates of up to 256kbit/s. – FLAC files (.flac). <ul style="list-style-type: none"> – Playlists in the M3U, PLS, ASX and WPL formats. – Playlists must not exceed 20 kB or more than 1000 entries. – File names and routes that do not exceed 256 characters. – On memory cards, a maximum of 4000 files and a maximum of 1000 files per directory.
<p>AUX Playback of audio files through the AUX-IN jack.</p>	<ul style="list-style-type: none"> – The external audio source must meet a series of playback conditions »» page 212.
<p> Play audio files over Bluetooth®^{b)}.</p>	<ul style="list-style-type: none"> – The external media player must be compatible with the A2DP Bluetooth® profile »» page 212.

^{a)} iPod™, iPad™ and iPhone™ are protected trademarks of Apple Inc.

^{b)} Bluetooth® is a registered trademark of Bluetooth® SIG, Inc.

Read and bear in mind the instruction manual for the external data storage device.

Limitations and indications

Dirt, high temperatures and mechanical damage can cause data media to fail. Con-

sider the indications provided by the manufacturer of the data media.

Quality differences between data media produced by different manufacturers can cause playback interference.

Consider copyright legislation!

The configuration of data media or of the equipment or programs used for recording may cause some tracks or data media to be unreadable. On the Internet, for example, can be found information about the best way to record audio files or data media (compression rate, ID3 tag, etc.).

The reading speed can vary considerably depending on the size, the usage status (copying and deleting processes), the structure of the folders and the type of files of the data media used.

Playlists only establish a certain playback order. The files are **not** saved in them. Playlists **cannot** be played if the files on the data media are **not** saved to the path to which the playlist refers.

A cover can only be displayed when the name starts with **"Cover"**, **"Folder"** or **"Album"**.

Note

- Do not use memory card adaptors, USB extension cords or USB hubs!
- SEAT assumes no liability for any deterioration or loss of files on data storage devices.

Playback order of files and folders

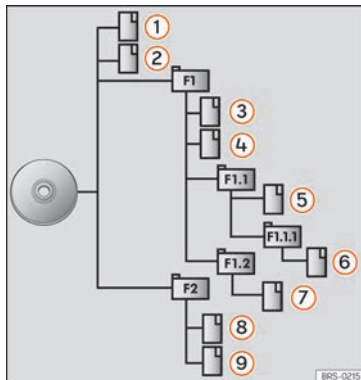


Fig. 203 Example of the structure of an audio data CD.

The audio files stored on data media are often arranged by file folders and playlists to establish a certain playback order.

Depending on their name on the data media, tracks, folders and playlists are ordered numerically and alphabetically.

The illustration shows an example of a conventional audio data CD, containing tracks, folders and subfolders. **Fig. 203.**

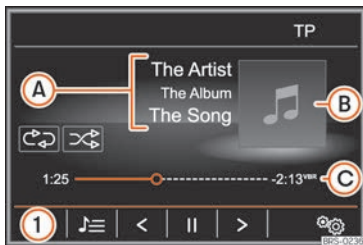
In this case the tracks will be played as follows¹⁾:

1. Tracks 1 and 2 in the root directory (Root) of the CD
2. Tracks 3 and 4 in the **first** F1 folder of the CD root directory
3. Track 5 in the **first** subfolder F1.1 of folder F1.
4. Track 6 in the **first** subfolder F1.1.1 of subfolder F1.1
5. Track 7 in the **second** subfolder F1.2 of folder F1
6. Track 8 and 9 in the **second** folder F2 »

¹⁾ The [Mix/repeat including subfolders] function must be active in the **Media settings** menu
» page 214.

Note

- The playback sequence can be modified by selecting the different playback modes »» page 206.
- Playlists do not play automatically, they have to be selected directly from the track selection menu »» page 208.

MEDIA main menu

Fig. 204 MEDIA main menu.

Using the *Media* main menu, different media sources can be selected and played.

- Press the infotainment button **MEDIA** to open the *Radio* main menu »» **Fig. 204**.

It will continue playing the last media source selected from the same point.

The media source being played is indicated on the dropdown list when the ① function button is pressed.

If there is no available media source, the *Media* main menu is displayed.

MEDIA main menu function buttons
Function buttons

Indicates the media source being played. Press to select another media source »» page 207.

Ⓢ CD: Internal CD drive »» page 209.

Ⓢ SD Card 1, Ⓢ SD Card 2: SD card »» page 210.

① Ⓢ USB 1 and Ⓢ USB 2: External data storage device connected to a USB port »» page 211.

Ⓢ AUX: External audio source connected to the AUX-IN multimedia socket »» page 212.

Ⓢ BT Audio: Bluetooth® audio »» page 212.

≡ **Selection** Opens the track list »» page 208.

< / > Changes track in Media mode »» page 207.

⏏ Playback stops. The ⏏ function button changes to ⏏ »» page 207.

Function buttons

▶ Playback is resumed. The ▶ function button changes to ⏏ »» page 207.

⚙ **Setup** Opens the **Media Settings** »» page 214 menu.

Press it to change mode.

↺: To repeat the current track.

↻: To repeat all tracks.

↺ Repeats all the tracks that are on the same memory level as the track being played now. If in the **Media Settings** menu the **(Mix/Repeat including subfolders)** option is enabled, it also includes the subfolders »» page 214.

Random play. The ⏏ function button changes to ⏏.

⏏ Includes all the tracks that are on the same memory level as the track being played now. If in the **Media Settings** menu the **(Mix/Repeat including subfolders)** option is enabled, it also includes the subfolders »» page 214.

Indications and symbols of the MEDIA main menu

Display: Meaning

Display track information (CD text, ID3 label in MP3 files).

A Audio CD: Displays the **track** and track number, according to the order on the data storage device.

Audio files: Displays the **name of the artist**, the **name of the album** and the **track** if available.

B^{a1} Displays the album cover if available in the data storage device.

The progress bar and the playing time so far and time remaining in minutes and seconds.

C **VBR:** In the case of audio files with variable bit rates the remaining time may vary.

Press the progress bar or press it and move it to skip to a different part of the track.

^{a1} Not available for the Media System Colour model.

Note

When the media source is inserted, playing will not start automatically; it is necessary for the user to select the source. Nor will the media source change when it is ejected.

Switching the Media source

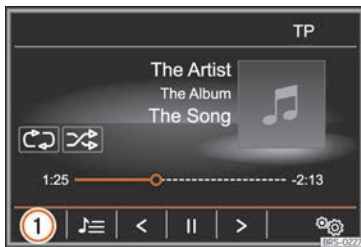


Fig. 205 MEDIA main menu.

- Lower the base volume on the Infotainment system.
- From the *Media* main menu, press the **[SOURCE]** function button **»»» Fig. 205** and select the desired media source.
- **OR:** From the *MEDIA* main menu, press the **1** function button and select the desired Media source.

In the pop-up window, the Media sources not selected are shown as deactivated (in grey).

When a Media source that has already been played is selected again, playback is resumed from the point at which it was stopped.

Note

The Media source can be changed in the *Track list* view: select **Media > View**.

Changing track in the MEDIA main menu

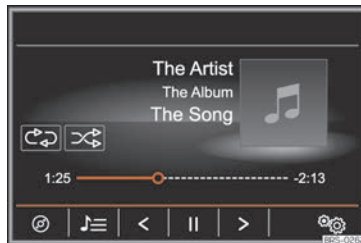











Fig. 206 MEDIA main menu.

The tracks of the Media source that is being listened to can be changed successively using the arrow buttons.

The arrow keys **cannot** be used to switch to playback from a playlist. Playback from a playlist must be started manually in the title selection menu **»»» page 208**.

»

Control through the MEDIA main menu

Meaning	Function
Briefly press the function button  once.	If the title has been playing for less than 3 seconds, it goes back to the start of the previous title. If the title has been playing for 3 seconds or more, it returns to the beginning of the title.
Briefly press the function button  once.	To the next title. From the last title, pressing this button switches to the first title of the data media that is being played.
Press and hold the function button  .	Rewind.
Press and hold the function button  .	Fast forward.
Briefly press the function button  once.	Playback stops. The  function button changes to  .
Briefly press the function button  once.	Playback is resumed. The  function button changes to .

Selecting a track from a track list

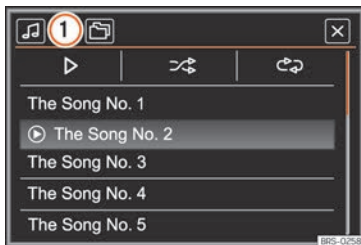


Fig. 207 List of titles of a Media source (folder view).

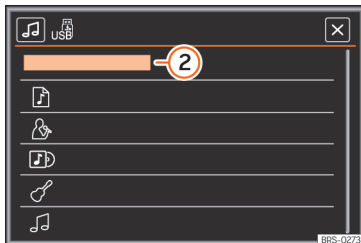



Fig. 208 USB data storage device: data bank view.

Open a title list

- Press the  function button **»» Fig. 206.**


- **OR:** Turn the adjustment knob. The track that is playing is highlighted **»» Fig. 207.**

Search the title list and press the title that you want. If there is title information available, the title and title number (on audio CDs) or file name (MP3) is displayed instead of **Title + number**.


Depending on the media source that is selected, you can choose between the **folder view** and the **data bank view** **»» page 209.**

Overview of the function buttons in the title list



Fig. 207 Function buttons


 Open the **Sources** menu. Press to select another Media source.

The currently selected Media source is displayed on the bar at the top of the screen. Press to change the media source.

 **CD**: Internal CD drive **»» page 209.**








1  **SD Card 1**,  **SD Card 2**: SD card **»» page 210.**

 **USB 1** and  **USB 2**: External data support connected **»» page 211.**

 **BT Audio**: External media player connected via Bluetooth® **»» page 212.**

 Press the function button to open the top folder of the Media source.

Fig. 207 Function buttons

	Start playback of the first title.
	Repeat all titles. The  function button changes to  . Repeats all the tracks that are on the same memory level as the track being played now. If in the Media Settings menu the (Mix/Repeat including subfolders) option is enabled, it also includes the subfolders »» page 214.
	Random play. The  function button changes to  . Includes all the tracks that are on the same memory level as the track being played now. If in the Media Settings menu the (Mix/Repeat including subfolders) option is enabled, it also includes the subfolders »» page 214.
x	To close the list of titles.

Data bank view¹⁾

The **data bank view** can only be generated by mass storage devices (USB and SD cards).

Depending on the volume of data, it can take a few minutes to generate the data bank view.






If there are too many files in the mass storage device, it may not be possible to generate the **Databank view**.

When generating the **data bank view**, existing titles are ordered according to the information available about titles in different categories and lists.

The existing tracks can be viewed and opened from these lists according to different classifications.

To switch between the **Data bank view** and the **Folder view**, press function button »» Fig. 208 ②.

Fig. 208 Function button: name

	List of tracks
	Artists
	Albums
	Genres
	Title

Note

Titles, folders and playlists can also be selected by turning the setting button and playing or opening them by pressing on them.

Insert or eject a CD

The driver should refrain from operating the unit while the vehicle is in motion. Insert or change the data storage device before moving off!

The CD drive can play audio CDs and audio data CDs.

Inserting a CD

- Insert the CD into the CD reader »» Fig. 177 »» Fig. 178 ④ with the printed side facing upwards, until the equipment inserts it automatically.

Ejecting a CD

- Press button **EJECT**.
- The CD is ejected and you have approximately 10 seconds to remove it.

If the CD is not removed within 10 seconds, it is automatically retracted for security reasons without activating the CD mode.

Illegible or faulty CD

If the data on an inserted CD cannot be read or a defective CD is inserted, the corresponding warning appears on screen. »»

¹⁾ Not available for model: Media System Colour

Depending on the equipment, unreadable CDs are automatically ejected 3 times and reinserted to start another three read attempts before this indication is displayed.

Note

- Uneven road surfaces and strong vibrations can cause playback to jump.
- When the temperature inside the equipment is too high, loading and playback of CDs is disabled.
- If after inserting a number of different CDs and receiving the CD drive error every time, contact a qualified workshop.

Insert or eject an SD card

The driver should refrain from operating the infotainment system while the vehicle is in motion. Insert or change the data storage device before moving off!

Only compatible audio files are displayed. Other files are ignored.

Inserting the SD card¹⁾

Media System Colour:

- Insert compatible SD cards, first on the side of the cut corner and with the label facing up (contacts facing down) in SD card slot »» Fig. 177 ⑦ until they lock into place.

Media System Plus / Navi System:

- **Left slot:** Enter a compatible SD card with the corner cut **upwards** and the title on the left (the contact surfaces pointed to the right) in the left SD card slot »» Fig. 178 ⑥ until it clicks.
- **Right slot:** Enter a compatible SD card with the corner cut **downwards** and the title on the right (the contact surfaces pointed to the left) in the right SD card slot »» Fig. 178 ⑥ until it clicks.

If an SD card cannot be inserted, make sure it is positioned correctly and is compatible with the unit.

Playback does not start automatically if there are audio files stored in the SD card and they can be read.

Ejecting the SD card

The inserted SD cards **must** be prepared for ejection.

- In the **MEDIA** main menu, press the **Settings** button to open the **Media Settings** menu.
- **OR:** Press the infotainment **MENU** button and then press **Settings** to open the **System settings** menu.
- Press the **Remove safely** function button and then **SD Card**. After correctly ejecting the data storage device from the system, the function button becomes inactive (grey colour).
- Press the inserted SD card. The SD card "jumps" to the eject position.
- Remove the SD card.

Illegible SD card

If the data on an SD card cannot be read, a warning will be displayed on the infotainment system.

The infotainment system switches to the last source selected.

Note

The navigation SD card may not be used as memory storage for other files. The Infotainment system will not recognise the files saved on it.

¹⁾ The number of slots for SD cards depends on the country and device in question.

External data storage device connected to the USB port

Depending on the features and the country, the vehicle may have one or two USB connections **»» page 239**.

The location of the USB ports  depends on the vehicle in question.

Where this manual refers to external data storage devices, this means USB mass storage devices containing supported audio files, such as MP3 players, iPods™ and USB sticks.

Only supported audio files are displayed and played. Other files are ignored.

Playback does not start automatically if there are audio files stored and readable in the SD card.

Further operation of the external data medium (changing track, selecting tracks and playback modes) is described in the appropriate chapters of this manual **»» page 203**.

Instructions and restrictions

Compatibility with Apple™ devices and other media players depends on the unit.


The USB port  supplies the usual USB voltage of 5 volts for a USB connection.






Due to the large number of different data storage devices and various iPod™, iPad™ and iPhone™ generations available, it is not

possible to guarantee fault-free operation of all functions described here.

Take into account all other instructions and limitations regarding requirements for media sources.



iPod™, iPad™ and iPhone™

Depending on the country and equipment, iPods™, iPads™ or iPhones™ can be connected via the device's own USB cable to the vehicle's USB port  and used as audio sources.

After connecting an iPod™, iPad™ or iPhone™, the list views specific to the iPod™ are displayed at the top selection level ( **Playlists**,  **Artists**,  **Albums**,  **Tracks**,  **Podcasts**, etc.).

Disconnecting

Data media **be** prepared for disconnection.


- In the *MEDIA* main menu, press the  button to open the **Media Settings** menu.
- **OR:** Press the infotainment **MENU** button and then press  to open the **System settings** menu.
- Press the  function button. A dropdown menu appears with the following options: SD1 Card, SD2 Card, USB1 and USB2. Pressing the corresponding function button disables it.

- Now the data storage device can be disconnected.

Unreadable data storage device

If a data storage device with unreadable data is connected, the infotainment system display will show a warning.

Note

- **Do not connect an external media player at the same time to play music via Bluetooth® and via the USB port  with the infotainment system, as this could cause playback limitations.**
- **If the external player is an Apple device™, it cannot be simultaneously connected by USB and by Bluetooth®.**
- **If a connected source is not recognized, disconnect and reconnect it. If the data cannot be played, the corresponding indication will be displayed.**

External audio source connected to the AUX-IN multimedia socket

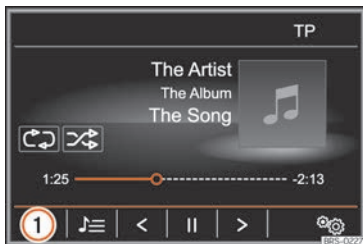


Fig. 209 MEDIA main menu.



Fig. 210 Media Mode: external audio source connected to the AUX-IN socket.

Depending on the equipment and country there may be an AUX-IN multimedia socket [»» page 239](#).

In order to connect the external audio source to the AUX-IN socket, a suitable cable is required with a 3.5 mm jack that is inserted into the AUX-IN socket of the vehicle.

The connected external audio source **cannot** be operated with the infotainment system's controls.

Connecting an external audio source to the AUX-IN multimedia socket

- Connect the external audio source to the AUX-IN multimedia socket.
- Start playback on the external audio source.
- In the *MEDIA* main menu, press the [»» Fig. 209](#) **1** function button and select **AUX**.

The **playback volume** of the connected external audio source should be adjusted to the volume of the other audio sources [»» page 181](#).

Information on operating an external audio source connected to the AUX-IN multimedia socket

Operation	Effect
Selection of another audio source from the Infotainment system.	The external audio source continues to run in the background.

Operation	Effect
Stopping playback on the external audio source.	The infotainment system remains in the AUX menu.
Remove the connector from the AUX-IN multimedia jack.	The infotainment system remains in the AUX menu.

Note

- Please read and observe the manufacturer's instruction manual for the external audio source.
- Interference noise may be heard if the external audio source is powered from the 12-volt power socket of the vehicle.

Connect an external audio source via Bluetooth®

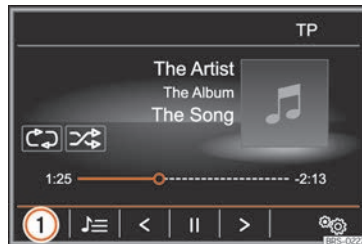


Fig. 211 MEDIA main menu.

In the Bluetooth® Audio mode, audio files that are playing on a device connected by Bluetooth can be listened to on the infotainment system.

Conditions

- The Bluetooth® audio source must support the A2DP Bluetooth® profile.
- In the **Bluetooth® Settings** menu the **Bluetooth Audio (A2DP/AVRCP)** function must be on. Select **Telephone > Settings > Bluetooth**

Starting a Bluetooth® audio transfer

- Turn on Bluetooth® visibility in the external Bluetooth® audio source.
- In the MEDIA main menu, press function button »»» **Fig. 211 ①** and select **BT audio**.
- Press **Search for new device** to connect an external Bluetooth® audio source for the first time »»» **page 227**.
- **OR:** Select a Bluetooth® audio source from the list.
- Please refer to the instructions on the screen of the infotainment system and on the Bluetooth® audio source regarding the rest of the procedure.

You may need to manually start playback on the Bluetooth® audio source.

When the Bluetooth® device is disconnected, the infotainment system remains in Bluetooth® audio mode.

Controlling playback

The extent to which the Bluetooth® audio system can be operated through the infotainment system depends on the connected Bluetooth® device.

i Note

- Due to the large number of possible Bluetooth® audio sources, it is not possible to guarantee fault-free operation of all described functions.
- Always switch off the warning and service tones on a connected Bluetooth® audio source, e.g. key tones on a mobile telephone, to prevent possible interference noise and malfunctions.
- The system response time may vary, depending on the connected external playback device.
- If the external player is an Apple device™, it cannot be simultaneously connected by USB and by Bluetooth®.

Images

✓ Not available for model: Media System Colour



Fig. 212 Images main menu.

Using the *Images* menu, image files can be viewed (e.g. photos) individually or as a slideshow.













The image files must be stored on a compatible data storage device.

Image files linked to complete address data can be used for image-based navigation »»» **page 224**¹⁾.

- Press the Infotainment **MENU** button and then select the **Images** context.
- Press the »»» **Fig. 212 ①** function button to select the source where the picture files in question are located.

¹⁾ Valid for: Navi System

Function buttons

	Display and selection of the source. Only sources with compatible image formats can be selected »» page 214.
	To rotate the view of the image 90 degrees to the left or the right.
	Reset the view of the image.
 Selection	Opens a list of image files.
	To change to the previous or next image.
	To stop the playback of a slideshow. The  function button changes to  .
	To continue the playback of a slideshow. The  function button changes to  .
 Setup	Image settings »» page 214.

Enlarging or reducing the view


- Slide 2 fingers across the screen, moving them further apart or closer together.
- **OR:** turn the settings button.

Requirements for viewing images


Image files	Maximum resolution
BMP	4MP
JPEG	4MP (Progressive Mode)
JPG	64MP
GIF	4MP
PNG	4MP

Image settings

Open the Image settings menu


- Press the  function button in the main *Images* menu.

Function buttons

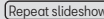
: To adjust the image view format.

Automatic: Images scale to the size of the screen (the image may not be displayed completely).

Complete: The images are displayed fully on the screen.

: To adjust the display time of images during a slideshow.


Function buttons


: The active slideshow is repeated infinitely.


Media settings


- Select the *MEDIA* main menu by pressing the Infotainment button **MEDIA**.
- Press the  function button to open the **Media settings** menu.

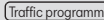
Function buttons

: Sound settings »» page 181.

: Subfolders are included in the selected playback mode »» page 203.

: Bluetooth® settings »» page 238

: To prepare external data media for extraction or disconnection. See also »» page 210, Insert or eject an SD card and »» page 211, External data storage device connected to the USB port «-«.

: The TP function (tracking of traffic information stations) is active »» page 200.

Navigation¹⁾

Introduction

General information

A GPS (Global Positioning System) satellite system locates the current position of the vehicle. The vehicle's sensors measure the distance travelled. The measurements are compared with the stored detailed map resources, according to road indications stored in them. Traffic reports, if any, will also be taken into account in the route calculation (dynamic route guidance »» page 222). Using all the data available, the Infotainment system calculates the optimum route to the destination.

The destination is defined by entering an address or a point of interest, e.g. a petrol station or hotel.

Navigation announcements and graphic representations will guide you to your destination.

Depending on the country, some functions of the infotainment system will not be available on the screen when travelling higher than a certain speed. It is not a malfunction, but is due to compliance with legislation.

⚠ CAUTION

The navigation announcements may be inaccurate [e.g. due to out-of-date data].

Instructions for navigation

When the Infotainment system is unable to receive any data from GPS satellites (tunnels, garages), navigation can still continue using the vehicle sensors.

Possible limitations in navigation

In areas that are not or are only partially digitised (e.g. insufficient definition of one-way streets and road categories), the Infotainment system will still attempt to provide route guidance.

In the case of missing or incomplete navigation data, it may not be possible to determine the exact position of the vehicle. This may mean that navigation is not as precise as usual.

Navigation area and update of navigation data

Road layouts change continuously. Therefore, if the navigation data are not updated, then errors or inaccuracies may occur.

SEAT recommends updating navigation data on a regular basis.

Updating and using navigation data from an SD card

The SD card is factory fitted in slot 2 for SD cards.

Navigation data that is currently valid for this unit in order to allow all functions to be used in full.

Updating navigation data

The current navigation data can be downloaded in the internet at www.seat.com and stored in a SD card compatible with the unit.

Suitable SD Cards can be acquired at SEAT dealerships.

The procedure is described on the internet at www.seat.com.

Using navigation data

- Insert the memory card »» page 210.
- Wait for the testing icon to disappear.

If the inserted memory card contains valid navigation data, the following message appears: **"The source contains the**

»

¹⁾ Only available for the model: Navi System

navigation database". Navigation can be started.

Note

- The inserted memory card must be prepared before it is ejected »» page 210.
- Navigation is not possible without the SD card.
- Do not remove the memory card while the navigation data is in use. This could damage the memory card!
- The navigation memory card cannot be used as a memory for other files.
- SEAT recommends using only the original SEAT cards. The use of other memory cards could limit its operation.

Navigation main menu

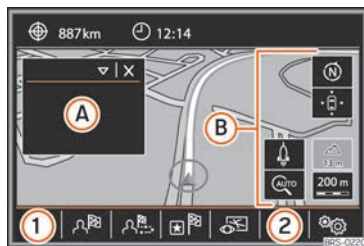


Fig. 213 Navigation main menu

Navigation functions can only be used if the navigation data for the area where the vehicle is driving is available in the infotainment system.

The **Navigation** main menu allows you to select a new destination, call up a previously used or stored destination and search for points of interest.

Opening the main Navigation menu

- Press the Infotainment system button **NAV** to open the last menu that was open in navigation.
- If the main *Navigation* menu is **not** displayed, press the infotainment button **NAV** again until the main *Navigation* menu is displayed.
- **OR:** Press the **↵** function button to return menu by menu to the *Navigation* menu.

Navigation main menu function buttons and indicators

Function buttons

- A** The split screen is displayed »» page 221.
- B** Messages and function buttons on the map display »» page 222.

Function buttons

- 1** **New destination** : To enter a new destination »» page 216.
- Route** : During route guidance »» page 218.
- 2** View the audio source selected (radio or Media).
- My destinations** To activate or manage stored destinations »» page 218.
- My route** To create or manage a route »» page 219.
- POI** Search for points of interest (e.g. hotels, fuel stations, etc.) within a particular search area »» page 220.
- View** To modify or activate or deactivate the split screen »» Fig. 213 **A** »» page 221.
- Setup** Open the **Navigation Settings** »» page 224 menu.

New destination (entering the destination)

- In the *Navigation* main menu, press the **New destination** function button .

- Press the **Options** function button and select the required type of destination (**Address, Address, POI** or **On map**).

Steering

When narrowing down the destination address, **please note** that every entry restricts the available range of subsequent selections.

To enter an address press the function buttons in the following order:

- Country, City** (or postcode), **Centre** (starts the route to the centre of the indicated city), **Street, Number, Junction, LAST DESTINATIONS, START** (starts route guidance to the selected destination).

Point of interest

Start the route towards a point of interest.

Function buttons

Search area: To select the area in which special destinations must be searched.

Surroundings of the location: Points of interest will be searched around the location.

Surroundings of the destination¹⁾: Points of interest will be searched around the destination.

On the route¹⁾: Points of interest will be searched along the route.

Surroundings of the address: Points of interest will be searched around the address entered.

Function buttons

Select on the map: Points of interest will be searched around the destination selected on the map. To select a destination on the map, press the **Edit** button.

Search category: Select the main category (e.g. **Vehicle and travel**), the category (e.g. **Airports**) and then the desired entry on the list.

Save: To save the selected point of interest in the destination memory » page 218.

Dial number: Establishes a telephone connection with the number stored for the point of interest.

Start: Starts guided navigation to the selected point of interest.

Search name: To search a point of interest entering the name or using synonyms of the categories (e.g. "Sleep" for hotels and hostels).

¹⁾ This function button is only displayed with route guidance activated.

On the map

- Select the destination on the map or enter it using GPS coordinates and confirm with **OK**.
- OR**: Enter the coordinates and confirm with **OK**.

Function buttons

Store: Store the point of interest in the destination memory » page 218.

Function buttons

Edit: Edit the destination or enter another one.

Route options: Setting route options, see **Navigation Settings > Route options**.

Start: Starts guided navigation to the selected point of interest.

After starting route guidance



Fig. 214 Route calculation.

When starting route guidance, the route is calculated based on the data that have been selected in the **Route options** menu.

Three **alternative routes** are proposed » **Fig. 214**. These 3 routes correspond to the selectable route options: *Economical, Fast and Short*.

- Blue route**: Economic route.

»

- **Red route:** Fastest route.
- **Orange route:** Shortest route to the destination, even if it results in longer travelling time.
- Select the desired route by pressing it.

The route criteria settings in the **Route options** menu are modified accordingly.

If a route is not selected, the route guidance starts automatically after approx. one minute according to the setting selected in **Route options**.

Once the route has been calculated, the system gives the first navigation announcement. Up to 3 navigation announcements are given before a turn.

- Press the adjustment knob to listen to the last audible navigation instruction.


The indicated distances depend to a great extent on the type of road and the traffic speed. On motorways, for example, navigation announcements are received much earlier than in urban traffic.

The corresponding navigation announcements are also given on roads with several lanes that split, and on roundabouts, for example: "Leave the roundabout at the second exit."

A navigation announcement informs you when you have reached your "destination".

A navigation announcement informing you that you have reached the "destination area" is given if the exact destination cannot be reached.

During **dynamic route guidance**, you receive information about reported traffic congestion on the route. An additional navigation announcement is given if the route is recalculated.


During a navigation announcement, you can change its volume using the button .


For other announcement settings, select **Navigation > Settings > Navigation announcements**.

Note


- If you miss a turning during route guidance and are currently unable to turn back, keep on driving until the navigation system offers a new route.
- The quality of the announcements and recommendations depends on the navigation data available and any reported traffic problems.



Route


In the *Navigation* main menu, press the  function button.


The  function button is only displayed when route guidance is activated.



Function buttons




: Aborts current route guidance.

: To enter a new destination or a new stopover  page 216.

: View route information for current route.





: To save the selected destination in the destination memory.

: Press to open the route mode  page 219.

: To exclude a section (of 0.2 to 10 km in length) from the current route, e.g. to avoid congestion. To cancel the exclusion, press the  function button and then .

My destinations (destination memory)

The stored destinations can be selected from the **My destinations** menu.

- Press the  function button in the main *Navigation* menu.
- Select the desired function: ,  or .

Store position

- By pressing the **Store position** function button, the entered position is stored as a **Flagged destination** in the **Destination memory**.

To save the stored position permanently as a **Flagged destination**, change the name of the position in the **destination memory**. Otherwise, the saved position is overwritten when another flagged destination is saved.


- Mark the **Flagged destination** in the **Destination memory**.
- Press the **Store** function button.

The name can be changed in the following input window. Press the **Store** function button to store the destination.


Destinations and contacts

- Select the desired function button.


Function buttons

Latest destinations : View of destinations for which a route has already been started.

Destination memory : View of destinations stored manually and from imported vCards [page 223](#), **Importing vCards** (electronic business cards).

Favourites : View of destinations stored as favourites.

Function buttons

Contacts : View contacts that have a stored address (postal address).


Home address


Only one address or position can be stored as the home address at any one time. The stored home address can be edited or overwritten.

If a home address has already been stored, route guidance will be started to the stored home address.

If a home address has not yet been stored, an address can be assigned as the home address.

Assigning the home address for the first time:

Current position : Press to store the vehicle's current position as the home address.

Address : Press to enter the home address manually.

Editing the home address:

The home address can be edited in the **Navigation settings** [page 224](#) menu.

My route (route mode)

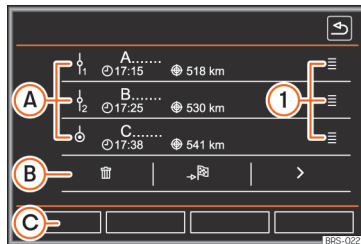



Fig. 215 Details of the route during route guidance.

Several destinations can be defined in the route mode. A trip with several destinations is known as a "route".

The "starting point" of a route is always the current vehicle position determined by the In-formation system. The "destination" is the end point of a route. "Stopover destinations" are driven to before the destination.

- Press the **My destinations**  function button in the main **Navigation** menu.
- Select the desired function button (**Edit route**, **New route** or **Route mem.**). **»**

Pop-up window function buttons My route

Function buttons

Edit route^{a)}: To edit and store the active route.

New route: To create a new route.


Route mem.: To **Delete**, **Edit** or **Start** the routes stored.


^{a)} This function button is only displayed with route guidance activated in the route mode.


Function buttons and indications in the New route and Edit route

Function buttons


 Stopover.


A  Destination.


 . . . : Estimated time of arrival at destination.

 . . . : Calculated distance to destination.

Press on the destination to display the function buttons.

 : Delete destination.

B  : To start guidance direct to the selected destination. Destinations that come before the selected destination are ignored.

 : To open the detailed view of the destination in question.

Function buttons

Available function buttons.

New dest.: To add a new destination to the tour.

Destinations: To add a new destination from **My destinations** to the tour.

C **Save**: To store the created tour in the tour memory.

Start: To start route guidance.

Calculate^{a)}: To update calculated distance and estimated arrival time.

Stop^{b)}: To stop route guidance to the active destination.

1 To move a stopover or a destination to another position on the list. Press and hold to move the destination.

^{a)} This function button is only displayed with route guidance activated and when a destination has been added to the tour.

^{b)} This function button is only displayed with route guidance activated.

Special destinations (POI)

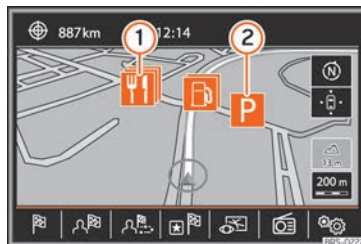



Fig. 216 Points of interest on the map.

The points of interest saved in the memory are divided into different categories. Each category of special destinations has a symbol assigned to it.

In the **Map settings** menu, you can indicate the special destinations that you want to display on the map. Up to 10 categories can be selected.

Display of points of interest on the map can be enabled or disabled with the **View**  **>>> page 221** button.

Selecting a point of interest on the map


Function buttons

There are several points of interest in the area.
1 Press this symbol to open a list of points of interest.

Function buttons

- ② The only point of interest in this zone. Press the symbol to open the detailed view of the point of interest.

Search for a point of interest

In the *Navigation* main menu, press the **Points of interest** function button .

Press the **More points of interest** button.

Function buttons

Search area: To select the area in which special destinations must be searched.

Surroundings of the location: Points of interest will be searched around the location.

Surroundings of the destination^{a)}: Points of interest will be searched around the destination.

On the route^{a)}: Points of interest will be searched along the route.

Surroundings of the address: Points of interest will be searched around the address entered.

Select on the map: Points of interest will be searched around the destination selected on the map. To select a destination on the map, press the **Edit** button.

Search category: Select the main category (e.g. **Vehicle and travel**), the category (e.g. **Airports**) and then the desired entry on the list.

Save: To save the selected point of interest in the destination memory **»»» page 218**.

Function buttons

Dial number: Establishes a telephone connection with the number stored for the point of interest.

Start: Starts guided navigation to the selected point of interest.


Search name: To search a point of interest entering the name or using synonyms of the categories (e.g. "Sleep" for hotels and hostels).


^{a)} This function button is only displayed with route guidance activated.


View


In the *Navigation* main menu, press the **View** function button.

Function buttons

 Map display in two dimensions (conventional).

 Map display in three dimensions (bird's eye view).

 To display the destination on the map.

 To display the route on the map.

Auto / Day / Night To switch between day and night format.

Function buttons

SPLIT SCREEN Show the split screen **»»» page 221**.

Press to display the categories of the points of interest selected on the map. Also see **»»» page 220, Special destinations (POI)**.

POI In the **Navigation settings** menu, under **Map settings** you can configure the categories of points of interest to display on the map **»»» page 224**.



^{a)} Only displayed with route guidance activated.

Split screen





Fig. 217 Split screen displayed.


The split screen **»»» Fig. 217 A** shows the information detailed below: **»»**


- In the *Navigation* main menu, press the **View**  function button.
- Enable the **Split screen** button by pressing .
- Press the **...**  function button, the split screen to select a display option.


Function buttons

Audio : Indicates the selected audio source.


Compass : Displays a compass with the current travelling direction and indicates the current position of the vehicle (street name).

Manoeuvre ^{a1} : The list of manoeuvres is displayed.

Road signs : Based on the features of the vehicle, the road signs stored in the navigation data [»» page 224](#) or the road signs recognised by the road sign detector are displayed [»» page 224](#).

Sat. data : current vehicle position in coordinates and GPS status (satellite reception).

^{a1} This is only active when route guidance is active.

Press the **X**  function button to close the split screen.

Map display

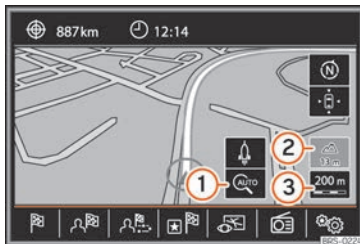




Fig. 218 Messages and function buttons on the map display.



Function buttons and messages on the map display.


To activate function buttons **1** and , press function button **3**.


Function buttons

1 To select automatic scaling. If the function is active, the symbol is displayed in blue .

2 Current altitude indicator.


3 View map scale ( or ). Rotate the settings button to modify the scale of the map.

 To change the orientation of the map (north-facing or direction of travel). This function is only available in 2D mode.

 To centre the exact vehicle position on the map.

Function buttons

To centre the exact destination on the map. This function button is only displayed if either *Destination on map* is selected [»» page 221](#).


 Briefly zooms in on the map. After a few seconds, it automatically returns to the last selected scale.

Traffic bulletins and dynamic destination guidance (TRAFFIC)


The Infotainment system constantly receives traffic reports (TMC/TMCpro) in the **background**, if a traffic information station is tuned.

Traffic bulletins are displayed on the map with symbols [»» page 223](#), **Traffic reports on map (selection)** and they are required dynamic destination guidance [»» page 223](#), **Dynamic route guidance**.

List of available traffic reports

- Press the **TRAFFIC** infotainment button to display the list of current traffic bulletins.
- Press the **...**  function button and select **A11** or **Route**.

Function buttons

All : All traffic bulletins received will be displayed.

Function buttons

Route: The traffic bulletins received that affect the calculated route will be displayed.

Dynamic route guidance

In order for dynamic route guidance to function, **Dynamic route** must be activated in the route options.

If a traffic report is received that affects the route being travelled, an alternative route will be searched for if the system calculates that time can be saved.

If, on the other hand, the alternative route does not save time, the route will continue with the traffic jam. In both cases, an announcement will be made.


Shortly before reaching the announced traffic jam, it is indicated again.

Avoiding a traffic jam by following the instructions of a traffic bulletin does not always save time, for example, if alternative routes are congested. The effectiveness of dynamic navigation depends on the traffic bulletins that are received.

The rest of the route that has to be travelled can be manually excluded to force its recalculation »» page 218.

Traffic reports on map (selection)

Symbol: Meaning

	: Slow traffic
	: Traffic jam
	: Accident
	: Slippery road surface (ice or snow)
	: Slippery road surface
	: Danger
	: Road works
	: Strong wind
	: Road closed to traffic

During route guidance, traffic incidents that do **not** affect the calculated route calculated are displayed in grey.

The length of a traffic jam on the calculated route is shown by a red line.

Incidents that affect the calculated route and that have led to the recalculation of the route are shown in orange.

The position of a symbol indicates the start of the traffic jam if it is precisely specified in the traffic bulletin.

Importing vCards (electronic business cards)

Importing vCards to the destination memory

- Insert the data storage device with the stored vCards or connect it to the Infotainment system »» page 203.
- Press the **Settings** function button in the Navigation main menu.
- In the **Navigation settings** menu, press the **Import destinations** function button.
- Select the data carrier with the vCards saved in the list.
- Press **Import all vCards from this folder**.
- Confirm the import notice with the **OK** function button.

Saved vCards will now be in the destinations memory »» page 218.

Note


Only one address per vCard can be imported. In the event any vCards have multiple addresses, only the main address will be imported.

Navigation with images



Fig. 219 Images main menu.

Selecting an image and starting route guidance

- Press the Infotainment **MENU** button and then select the **Images** context.
- Press the »» Fig. 219 ① function button and select the data storage device where the images are stored.
- If the image displayed was taken using GPS localisation, the  function button will appear. Press to start guidance to a destination.

Road signs indication

The road sign indication must be active in the **Navigation settings** menu »» page 224.

If there are road signs stored in the navigation data for the route you are driving on, the sys-

tem can display them on the map (e.g. a speed limit).

Take into account the age of the navigation data and the limitations of the navigation system »» page 215!

Recognition of road signs

Some vehicles have a road sign recognition camera. If the vehicle has road sign recognition and it is active, road signs detected by the system will be displayed on the map, along with additional information.

Read and take into account the information and indications of the road signs recognition system »» page 78.

Route guidance in Demo mode

If demo mode is activated in the **Navigation settings** menu, an additional pop-up window opens when you start route guidance.

- Pressing the **Demo mode** function button starts a “virtual route guidance” to the destination you have entered.
- If you press the **Normal** function button, a “real route guidance” starts.

The development and operation of virtual route guidance is compatible with the development and operation of real route guidance.

Virtual route guidance is repeated after reaching the fictitious destination and restarts from the starting point, if it is **not** interrupted beforehand.


When the starting point of the Demo mode is manually set **Navigation settings** menu, the virtual route guidance starts from that position.

A manually entered starting point is overwritten with the current location of the vehicle, if the vehicle starts moving.

Note

Deactivate the Demo mode after use, otherwise you will always have to select whether to start a virtual route or normal route before starting route guidance.

Navigation settings

- Press the **Navigation** function button in the main **Settings**  menu.

Function buttons

Route options: To make the route calculation adjustments.

Function buttons

Suggest 3 alternative routes: After starting route guidance, 3 alternative routes are proposed » page 217.

Route: Route type selection.

Economical: Route calculation, taking economic aspects into account.

Fast: The fastest route to the destination.

Short: The shortest route to the destination, even if it results in longer travelling time.

Dynamic route: Dynamic route guidance activates when a TMC is received » page 222.

Avoid motorways and highways: Motorways will be excluded from the route calculation wherever possible.

Avoid ferries and motorail trains: Ferries and motorail trains will not be taken into account for the route calculation, wherever possible.

Avoid toll roads: Toll roads will be excluded from the route calculation, whenever possible.

Avoid tunnels: Tunnels will be excluded from the route calculation, whenever possible.

Avoid routes requiring toll stickers: Mandatory toll stickers (stickers certifying that the toll has been paid) will be excluded from the route calculation whenever possible.

Function buttons

Show available toll stickers^{pl}: To mark the available toll stickers on the list
(**Avoid routes requiring toll stickers**) must be active). Routes requiring toll stickers will be taken into account in the route calculation if it is marked that the toll sticker is available.

Map: To adjust the map display settings.

Show road signs: The road signs stored in the navigation data for the road you are driving on are displayed during route guidance » page 224.

Lane guidance: During route guidance, an additional indication is displayed to recommend a lane when driving, and when turning on roads with several lanes. Only if the data bank contains information about the area that is being driven through.

Show favourites: The destinations saved as favourites on the map are displayed (★).

Show POIs

Select categories for POIs: To select the POI categories shown on the map » page 220.

Show brand logos for POIs: Displays logos of the selected special destinations categories (e.g. displays logos of service stations).

Manage memory: To make adjustments to the stored destinations.

Sort contacts: To select the sequential order of agenda entries recorded with postal addresses, see also » page 218.

Define home address: To assign or edit a home address, see also » page 219.

Function buttons

Delete user data: To delete stored destinations (e.g. **Last destinations** or the **Destination memory**).

Navigation announcements: To change the navigation announcements settings.

Volume: To adjust the volume of audible driving recommendations.

No navigation announcements during calls: During a telephone conversation, audio driving recommendations will not be given.

Speed limits: Shows the speed limits, depending on the road, of the country that is being driven through.

Fuel options: To change fuel related settings.

Select preferred petrol station: The brand of the selected service station is given priority in special destination search results.

Fuel warning: The fuel warning is active.

If the fuel level reaches the reserve, an appropriate warning is generated that enables the service station search.

Import destinations: To import digital business cards (vCards) into the destination memory » page 223.

Version information: Information about stored navigation data.


Advanced settings: For making advanced changes to the navigation settings.

Time display: Indication ⌚ during route guidance. »

Function buttons

Time of arrival: The estimated time of arrival at the destination is displayed.

Running time: The envisaged travelling time to the destination is displayed.

Status line: View  during route guidance.

Destination: The calculated distance to the destination is shown.

Next stopover: The calculated distance to the next stopover is shown.

Note: National border crossed: Indication of the speed limits of the country in question when crossing a border.

Demo mode: When the Demo mode is active and route guidance is started, a virtual guide to the entered destination may be started » page 224.

Define demo mode starting point: If the Demo mode is active and the vehicle is stopped, a fictitious starting point can be set for the virtual route guidance.

^{a)} This functionality will depend on the country.

Telephone

General information

Telephone functions can only be used if there is a mobile phone connected by Bluetooth to the infotainment system » page 228.

To do this, the phone must have the **Bluetooth® function** activated.

The instructions shown on the screen for the telephone menus will depend on the mobile telephone used.

Only use compatible Bluetooth® devices. For further information on compatible Bluetooth® products, ask your nearest SEAT dealer or check on the Internet.

Use the instruction manual of the mobile telephone and of any accessories.

If you detect any operating issues between your mobile telephone and the Infotainment system, restart your mobile by switching it off and on again.

Some functions and setup can only be performed when the vehicle is stopped and are not available on all mobile telephones.

You may experience poor reception or may be cut off in areas where the signal is weak.

Most electronic devices are shielded against HF (high-frequency) signals. In any case, the electronic equipment may not be protected from the HF signals of the telephone management system. This may cause interference.

Priority mobile phone

A priority-connected mobile phone has **full** access to the user profile.

It offers all the telephone management system functions.

Associated mobile phone

A mobile phone connected as an associate does **not** have access to the user profile.

Incoming calls can be received and maintained through the phone's management system.

Outgoing calls can only be maintained through the phone's management system, if they have been started with the mobile phone.

During a telephone call the functions » page 231, **During a phone call** are available.

WARNING

General, mandatory, legal and country-specific instructions and laws for the use of mobile phones inside the vehicle must always be considered.

WARNING

Speaking by telephone and using the mobile telephone management system whilst driving can distract you from the road and cause an accident.

- **In areas of little coverage your call may be cut off and you may not be able to make even emergency calls.**

WARNING

Mobile telephones may interfere with and alter the correct operation of pacemakers if they are carried directly over them.

- Maintain a minimum distance of at least 20 centimetres between the aerials of the mobile telephone and the pacemaker.
- Do not carry your switched-on mobile telephone in your breast pocket directly over the pacemaker.
- If you suspect interference, switch off the mobile telephone immediately.

CAUTION

High speeds, poor weather or road conditions and the quality of reception can all affect the audio quality of a telephone conversation in the vehicle.

Note

- Restrictions on the use of devices using Bluetooth® technology may apply in some countries. For further information, contact the local authorities.
- If you wish to connect a device via Bluetooth®, consult the safety warnings in its instruction manual. Use only compatible Bluetooth® products.
- Using a mobile telephone inside the vehicle may provoke noise in the speakers.

- Some networks may not recognise all of the language characters or offer all of the services.

Places with special regulations

In the majority of cases, these places are signposted, but not always clearly. They include, for example:

- The vicinity of chemical pipelines and tanks.
- The lower decks of boats and ferries.
- In the proximity of vehicles that run on liquid gas (such as propane or butane).
- Places where the air is laden with chemicals or particles such as flour, dust or metal powder.
- All other places where the vehicle engine must be switched off.

WARNING

Switch off the mobile phone in areas with a risk of explosion! The mobile telephone may automatically reconnect to the mobile telephone network if it loses the Bluetooth® connection to the telephone management system.

CAUTION

In areas where special regulations apply or the use of mobile telephones is prohibited, both the telephone and the telephone management system must always be switched off. Interference may be caused with sensitive technical and medical equipment, possibly resulting in a malfunction or damage to the equipment.

Bluetooth®

Bluetooth® technology allows a mobile telephone to be connected to your vehicle's telephone management system. Prior pairing between the two is required for this purpose.

Some Bluetooth® mobile telephones connect automatically when the ignition is turned on if a connection has been previously established. Its Bluetooth® function must be activated for this purpose, and there must be no Bluetooth® connection with other devices.

Bluetooth® connections are free.

Bluetooth® is a registered trademark of Bluetooth® SIG, Inc.

Bluetooth® profiles

When a mobile phone is connected to the telephone management system, a data exchange takes place via one of the Bluetooth® profiles. »

- **Hands-free telephone profile (HFP):** the HFP can be used to manage calls through the infotainment system.
- **Audio profile (A2DP):** This profile allows audio to be transmitted with stereo quality. It may require connecting other profiles for managing and controlling playback.
- **Phone book access profile (PBAP):** Allows phone book contents to be downloaded from the mobile telephone.
- **Message profile (MAP):**¹⁾ It allows short messages (SMS) to be downloaded and synchronised.
- **Audio and video remote control profile (AVRCP):** To view information of tracks and control playback on the mobile device.

Note

The mobile telephone's button and warning tones should be off. Where necessary, disconnect the headset from the mobile telephone you wish to connect to the system.

Pre-installation for mobile phone Basic

If there is a mobile phone connected to the telephone management system through the

¹⁾ Not available for the Media System Colour model.

Bluetooth® Hands-Free-Profile (HFP), you can make phone calls with the hands-free system.

The aerial of the vehicle *cannot* be used.

Take into account the instructions to use a mobile telephone in the vehicle without connection to the external antenna »» page 346.

Possible types of connection Basic

The types of connection depend on the country and device in question.

To see the meaning of the acronyms and terms of the table, see »» page 227.

Device 1	Device 2
HFP (with priority) + A2DP/AVRCP	HFP (associated)
HFP (with priority)	HFP (associated) + A2DP/AVRCP
HFP (with priority)	HFP (associated)
HFP	A2DP/AVRCP
HFP (with priority) + A2DP/AVRCP	—
HFP	—

Pairing and connecting a mobile telephone to the Infotainment system

In order to manage a mobile telephone via the Infotainment system, it is necessary to pair both devices **once**.

For your safety, pairing should be done when the vehicle is stationary. In some countries it is not possible to perform the pairing with the vehicle running.

Conditions

- The ignition must be switched on.
- The **Bluetooth® function** of the mobile phone and the infotainment system must be active and visible.
- The **keypad lock** on the mobile telephone must be deactivated.

Follow instructions in the manual for the mobile telephone.

During the pairing process, it is necessary to enter data via the mobile telephone's keypad.

Pairing a mobile telephone

- Press the infotainment **PHONE** button.
- Press the **Find telephone** function button.

As soon as the search is completed, the names of the Bluetooth® devices found are displayed on-screen.

- Turn on the mobile phone you want to pair on the list of Bluetooth® devices found.

The infotainment system and the mobile phone can be connected to each other. To terminate the connection of both devices, you might have to enter more data on the mobile phone and the Infotainment system.

- If necessary, confirm the pairing on the mobile phone.

Depending on the mobile phone:

- Use your mobile telephone to enter and confirm your PIN code, as instructed in the display of the infotainment system.

OR:

- Compare the PIN code shown on the display of the Infotainment system with that shown on the mobile telephone. If they match, confirm on **both** devices.

Once the pairing has completed successfully, the *Telephone* main menu is displayed along with the phonebook, call list and SMS stored on the mobile phone, which are automatically loaded. Confirmation on the mobile phone may be necessary.

The duration of the loading process depends on the amount of data stored on the mobile telephone. After loading, the data will be available on the Infotainment system.

Pairing and connection of mobile telephones

You can pair up to 20 mobile telephones to the Infotainment system, but the number of simultaneous connections varies:

- *Media System Colour*: one phone connected to the hands-free profile and the same or a different one as Bluetooth® audio.
- *Media System Plus / Navi System*: two mobile phones simultaneously connected to the hands-free profile, and one of them as Bluetooth® audio.

When the Infotainment system is switched on, it connects to the last connected mobile telephone. If it is not possible to connect to this mobile telephone, the system will try to connect to the next mobile telephone on the list of paired devices.

The **maximum** range of the connection is approx. **10 metres**. The connection will be interrupted if this distance is exceeded. The connection is **automatically** re-established as soon as the device is once again within Bluetooth® range.

⚠ WARNING

Do not perform the pairing and connection process while driving. This may cause an accident!

i Note

Check that there are no requests pending acceptance in your mobile phone. If there are, this could block some of the functions in the Telephone menu.

Switching the telephone management system off

- End the current call.
- Switch the ignition off.
- Remove the key from the ignition switch.
- Turn the mobile phone off.

If the key is still in the ignition switch after turning off the ignition, it will **not** turn off. After around 15 minutes of delayed disconnection (default value) the telephone management system will switch off.

i Note

If there was a mobile phone connected to the telephone management system, the emitting unit of the mobile phone will still be on after turning the phone management »

system off. You might have to turn off the mobile phone.

Telephone main menu

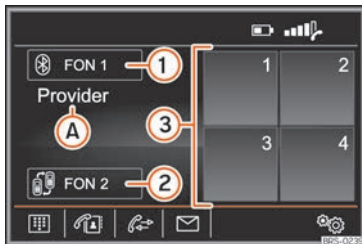


Fig. 220 PHONE main menu.



Fig. 221 Incoming call.

User profile

A connected mobile phone is stored in the telephone's management system as a user profile.

The telephone management system can store up to a **maximum of 4 user profiles** for mobile telephones. If another mobile phone is paired, the user profile that has not been used for the longest time is automatically deleted.

The user profile stores the phone's contact data, the stored favourites (speed-dial buttons) and the settings in the **User profile settings** menu.








When the mobile phone connects to the telephone management system again, the data and settings become available again.

If any entries in the mobile phone book are modified while connected, a manual update of the phone book data can be initiated from the **User profile settings** » page 238 menu. The next time that the mobile telephone is connected (e.g. on the next journey) the phonebook is updated automatically.

Opening the PHONE main menu

Press the **PHONE** button on the Infotainment system to open the *Telephone* » Fig. 220 main menu.

Function buttons

①	Mobile phone with priority ^{a)} and connected. Press to connect or pair a different mobile phone.
② ^{b)}	Associated mobile phone ^{a)} and connected. Press to change its priority. The associated mobile phone becomes the priority mobile phone and vice-versa.
③	Favourites (speed dial buttons), to which a contact can be assigned » page 237.
 Dial number	To open the number pad and enter a telephone number » page 232.
 Contacts	To open the contacts of the paired mobile phone » page 233.
 SMS ^{c)}	To open the SMS menu » page 235.
 Calls	To open call lists of the paired mobile telephone » page 236.
 Setup	To open the Telephone settings » page 237. menu.
	Press to accept a call.
	Press to end a call.
	OR: Press to reject an incoming call.

Function buttons



Press to mute the call signal during a call and to reactivate it.

- a) See more information about priority or associated mobile phones and about user profiles » page 230.
- b) Only displayed if the associated mobile telephone is connected. Not available for the Media System Colour model.
- c) Depending on the mobile phone connected. Not available for the Media System Colour model.

Instructions and symbols of the phone management system

Display: Meaning



Name of the mobile network operator (provider) of the SIM of the paired phone.

View of stored telephone number or name. If the stored contact has an assigned image, it can be displayed » page 237^{a)}.



When receiving a call, the name of the mobile phone receiving the call is displayed (priority or associated mobile phone).



Paired mobile telephone battery charge status.



Strength of coverage signal received by the mobile telephone.

- a) Depending on the mobile phone connected. Not available for the Media System Colour model.

During a phone call



Fig. 222 During a phone call.

After starting a call with a phone number, the *PHONE* main menu switches to the *Phone call* screen » **Fig. 222**.

Display and function buttons: operation and effect



Press to disconnect the microphone of the pre-installation for mobile phone during a phone call (button switches to).



Press to connect the microphone of the pre-installation for mobile phone during a phone call (button switches to).



Press to keep the phone call through the pre-installation for mobile phone.

Display and function buttons: operation and effect

View of stored telephone number or name. If the stored contact has an assigned image, it can be displayed » page 237^{b)}.



When receiving a call, the name of the mobile phone receiving the call is displayed (priority or associated mobile phone).

Press to open the detailed view of the contact.

Press to hold a call.



When there is a call on hold, audio transmission is off. Phone calls held in the vehicle are not transmitted.



Press to end a call.

- a) This button is only displayed when the phone call is on the mobile phone.
- b) Depending on the mobile phone connected. Not available for the Media System Colour model.
- c) Not available for the Media System Colour model.

Functions during a phone call

Functions available

Mute the microphone of the pre-installation for mobile phone


Press the function button.



The microphone of the pre-installation for mobile phone is muted (button switches to).





Functions available



Turn on the microphone of the pre-installation for mobile phone

Press the  function button.


The microphone is enabled (button  switches to .



Have a phone call via the mobile phone



Press the function button  and then .

The hands-free system is disabled and the phone call continues on the mobile phone (button  switches to .

Return to the phone call through the pre-installation for mobile phone.

Press the  function button.

OR: Press the  function button and then press .

The hands-free system is enabled and the phone call continues on the pre-installation for mobile phone (button  switches to .

Enter telephone number menu


Fig. 223 Enter telephone number menu.

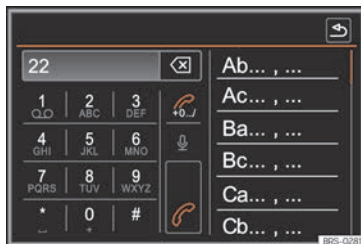


Fig. 224 Enter telephone number menu (select a contact from the list).

Open the Enter telephone number menu

- Press the  function button to open the **Enter phone number** menu.

SOS Emergency call¹⁾

- Press the function button to make an emergency call.

 Assistance call¹⁾



- Press the function button to obtain help in the event of breakdown.

SEAT, S.A. Authorised Services are also at your disposal with their mobile units.


 Information call¹⁾

- Press the function button to obtain information about the SEAT, S.A. brand and selected additional services related to traffic and travel.

 Call mailbox

- Press the  function button to start the connection.
- **OR:** Press the  function button for about 2 seconds to start the connection.


¹⁾ This depends on the country and unit in question. Not available for the Media System Colour model.

If the number for the mailbox has not yet been stored, enter it and confirm with .

Stored numbers can be modified in the **User profile settings** » **page 238** menu.

¹⁾ Prefix function

The prefix function serves to add a prefix to the phone number entered or stored when dialling, e.g. to make a phone call from a different profile of the SIM (Dual/TwinBill) or to cancel service or control orders on the phone network (e.g. hide phone number).

- Enter the phone number without the prefix and press .

The prefix stored in the **Use profile settings** » **page 238** menu is automatically placed before the phone number and the call starts.


²⁾ Voice input

- Press the function button to start a connection through voice control through a phone number.

¹⁾ The function button is only displayed when the prefix button is enabled in the **User profile settings** » **page 238** menu.

²⁾ This depends on the country and unit in question. Not available for the Media System Colour model.

Enter telephone number


- Entering a phone number with the keypad. Press the  function button to make a call.

Select a contact from the list

- Enter the first letters of the contact to find using the keypad. The available entries appear on the list of contacts » **Fig. 224**.
- Search in the phonebook and press the desired contact to establish the connection.

Enter the country code

To enter a country code, instead of the first two digits (international access code e.g. "00") you can enter the character "+".

- Press the function button  for approx. 2 seconds to add the +.

Phonebook Menu (contacts)

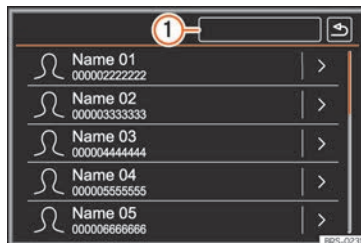


Fig. 225 Contacts Menu (phonebook).




Fig. 226 Search window.

Once the first pairing is made, it may take some time until the phonebook data¹⁾ of the paired mobile are available in the infotainment system. Depending on the volume of data that has to be transferred, the process may take several minutes. It may be necessary to confirm the data transmission on the mobile phone.

The phonebook can also be viewed during a telephone conversation.

If the name saved in the phonebook has an assigned photo, it can be displayed on the list next to the name. To do this, the option **Show pictures for contacts** in the **Phone settings** context must be enabled and your mobile phone must support this functionality (check the compatibility list) »» page 237, **Phone settings**.

In the **Telephone** main menu, press the **Contacts**  function button to access the phone book.

Select a contact from the list

- Search the list and press on the desired contact to make the call.


¹⁾ Depending on the device, only contacts in the phone's memory are loaded.

²⁾ Not available for the Media System Colour model.

³⁾ Valid for Navi System and Navi System Plus.

- **OR:** If the contact has several numbers, first press on the contact and then press on the desired number for making the call.

Search for a contact in the search window


- Press the **Search**  function button »» **Fig. 225** to open the search window.
- Enter the name of the contact you are looking for in the window »» **Fig. 226**. While the characters are being entered, a contact is displayed in the input field.
- The number of matching results is displayed to the right of the input field. Press the function button to go to the list.
- Search the list and press on the desired contact to make the call.

Opening the detailed view of a contact

- Press the function button **>** »» **Fig. 225** located next to the entry in the contact list²⁾.

All the telephone numbers are displayed in the detailed view, and where applicable, the address recorded for the contact in question.


Read contact name

- Press the function button  on the detailed list if you want the voice control system to read the name of the contact ²⁾.

Call a contact

- Press the desired telephone number on the detailed list to make the call.

Send SMS to a contact

- Press the function button  on the detailed list²⁾.

Start route guidance to a contact's address³⁾

If the contact's address data has been saved, route guidance can be started to the contact's address.

- Press address data in the detailed view to start route guidance.

Note

If you edit a number before calling, it will not be saved in the phonebook but only used for the call.

Short messages (SMS) menu

✓ Not available for model: Media System Colour

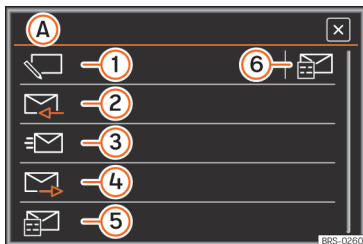


Fig. 227 Short messages (SMS) menu.



Fig. 228 Overview of possible function buttons in submenus.

Requirements

To receive, view and send short messages (SMS) via the infotainment system, the mobile phone connected to the infotainment system **must** be compatible with the **MAP** » page 227 Bluetooth® profile.

Due to the large number of different Bluetooth devices on the market, it cannot be guaranteed that all of the functions will be executed.

Opening the short messages (SMS) menu

- Press the **[SMS]** function button from the **TELEPHONE** main menu.

Function buttons

Indicates the selected menu.

- A** : To return to the short message (SMS) menu » **Fig. 227**.

- 1 New SMS:** To write and send an SMS.
- 2 Inbox:** To open the received SMS folder.
- 3 Sent:** To open the sent SMS folder.
- 4 Outbox:** To open the outbox folder. SMS messages that have not been sent are stored here.
- 5 Drafts:** To open the Drafts folder. SMSs stored as drafts are saved here.

Open the **Templates** menu: To select a text template from the list.

- 6** During route guidance, a template is prepared with the current destination [**I am on my way to <...> <...>**].

- X** To return to the main **PHONE** menu.

Possible submenu function buttons



The number of functions available depends on the mobile phone that is connected.

Function buttons

- 7** For the voice control system to read the text of the SMS. »

Function buttons

Open the **Options** menu.

- 8 **Reply with template:** To select a text template from a list.
- Show numbers:** The telephone numbers that are included in the message are displayed.
- 9 To forward an SMS.
- 10 To reply to an incoming SMS.
- 11 The text is saved as a draft and can be sent later.
- 12 Open the **Templates** menu: To select a text template from the list, see also 6.
- To open the number pad  and enter a telephone number.
- 13 **OR:** To select a recipient from the contacts list.
- 14 To add more recipients by entering a telephone number or contacts list.
- 15 To send an SMS.
- 16 To delete an SMS.
- 17 To open the number pad  and enter a telephone number.

Calls Menu (call lists)

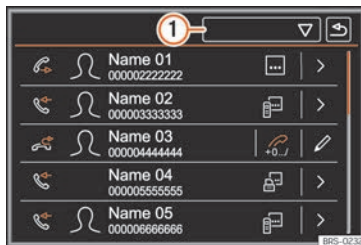




Fig. 229 Calls Menu (list of calls).

If a telephone number is stored as a contact, the stored name is displayed on the call list instead of the number.







If an image is assigned to the contact, it can be displayed on the call list next to the name **>>> page 237.**

Open the Calls menu

- Press the **Calls**  function button to open the **Calls** menu.
- Press function button  **>>> Fig. 229 1.**
- Select the desired call list: **All**, **Missed calls**, **Dialled numbers** or **Received calls**.

Possible displays in the Calls menu

Display: Meaning

-  **Missed calls:** Displays the numbers of missed and unanswered calls.
-  **Dialled numbers:** Indicates the numbers dialled on the mobile telephone and on the Infotainment system telephone management system.
-  **Received calls:** Indicates the numbers of the calls received on the mobile telephone and on the Infotainment system telephone management system.
-  The stored prefix is placed before the phone number automatically and the connection is started. Also see **>>> page 232, Enter telephone number menu.**
-  Opening the detailed view of a contact. All the telephone numbers are displayed in the detailed view, and where applicable, the address recorded for the contact in question.
-  The phone number is copied to the **Enter phone number menu >>> page 232.**

^{a)} Not available for the Media System Colour model.

Note

The availability of the call lists will depend on the mobile phone used.

Quick dial keys

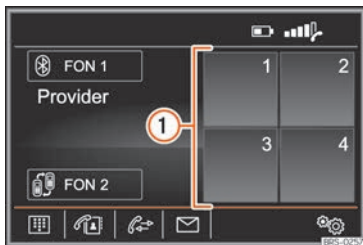


Fig. 230 PHONE main menu.

The speed dial keys » Fig. 230 ① can be assigned a telephone number from the phone book.

If a photo is assigned to the name stored in the phone book, it can be displayed on the speed dial key » page 237¹⁾.

All speed dial keys have to be manually edited and will be assigned to a user profile. Up to 12 contacts can be added to the speed dial keys.

Assign the speed dial keys

- In the main *Telephone* menu, press a **free** speed dial key.

- Select the desired contact from the list. If the selected contact has several phone numbers, select the number you want.

Edit assigned speed dial keys

- Press and hold an **occupied** speed dial key in the *Telephone* main menu until the *Contacts* menu opens.
- Select the desired contact from the list. If the selected contact has several phone numbers, select the number you want.

Delete assigned speed dial keys

- The phone numbers stored in the speed dial buttons can be deleted in the menu **User profile settings > Manage favourites** » page 238.


Make a call with a speed dial button

- Briefly press an **assigned** speed dial key in the *Telephone* main menu to call the telephone number stored in it.

Note

The contacts stored in the speed dial keys are **NOT** updated automatically. If a contact stored on a speed dial key is modified on the mobile phone, the speed dial key must be assigned again.

Phone settings

In the *Telephone* main menu, press the **Settings**  function button.

Function buttons

Private mode: Private mode can only be activated during an active call. When private mode is disabled (by default), the call's audio is managed through the vehicle. When private mode is activated, call audio is managed through the mobile phone.

Select mobile phone: From the list, select the mobile phone to be connected to the hands-free profile with the infotainment system.

OR: Press **Find telephone** to connect a new mobile phone.

Bluetooth: Opens the menu **Bluetooth settings** » page 238.

User profile: Open the **User profile settings** menu » page 238.

Note

Some telephones require a restart to download the last added contacts again.

¹⁾ Not available for the Media System Colour model.

Bluetooth® settings

- In the *Telephone* main menu, press the **Settings** function button.
- **OR:** Press the infotainment **SETUP** button.
- Next, press the **Bluetooth** function button.

Function buttons

Bluetooth: Press to deactivate Bluetooth®. All active connections are disconnected.

Visibility: Activating and deactivating Bluetooth® visibility.

Visible: Bluetooth® visibility is active.

Hidden: Bluetooth® visibility is deactivated. Bluetooth® visibility must be active for external pairing of a Bluetooth® device with the infotainment system. When a Bluetooth® audio device is active and playing, visibility is automatically set to **Hidden**.

Forename: Display or change the Bluetooth® name of the infotainment system. This will be the name shown to other Bluetooth® devices.

Paired devices: Viewing paired devices. To disconnect and connect Bluetooth® devices and Bluetooth® profiles.

Find devices: Search for visible Bluetooth® devices that are within range of the infotainment system. The **maximum** range is approx. **10 meters**.

Bluetooth® Audio (A2DP/AVRCP): If an external audio source is to be connected to the infotainment system via Bluetooth®, this function must be active
»» page 212.

User profile settings

In the *Telephone* main menu, press the **Settings** function button and then press the **User profile** function button.

Function buttons

Manage favourites: Edit the speed dial keys.

Delete all: All favourites are deleted.

Occupied speed dial key: Press to delete the stored number.

Free speed dial key: Press to save a phone book number on the speed dial key.

Mailbox number: To enter or change the voice mailbox number.

Prefix: To enter the prefix that must be prefixed to the entered number »» page 232.

Sort by: To set the order of appearance of the phone book entries (**Forename** and **Surname** or vice versa).

Import contacts: Press to import the phone book of the connected telephone or to update the imported phone book.

Delete other user profiles: To delete all non-active user profiles or just one of them.

Select ring tone^{a)}: To select a ring tone from a list of preset melodies (tones). The selected ring tone is played and set when leaving the sub-menu.

Function buttons

Reminder: remember your mobile phone: If a Bluetooth® connection is active with a mobile phone, the message **"Do not forget your mobile phone"** is displayed when the ignition is switched off.

Show pictures for contacts^{b)}: If the contacts in the phone book have been saved with a photo, it can be displayed on the speed dial keys, call lists and phone book^{b)}.

^{a)} Depending on the mobile phone.

^{b)} Not available for the Media System Colour model.

Note

Some telephones require a restart to download the last added contacts again.

Multimedia

USB/AUX-IN input



Fig. 231 Centre front armrest: USB/AUX-IN input.

Depending on the special characteristics and the country, the vehicle may have a USB/AUX-IN port.

The USB/AUX-IN port can be found in the storage compartment area of the centre console »» **Fig. 231**.

Convenience phone system

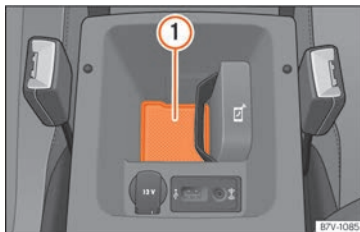


Fig. 232 The phone holder used for connecting the mobile phone to the car aerial is located in the front centre armrest.

Comfort phone service with connection to the aerial of the vehicle is available for mobile phone standards GSM 900, GSM 1800 and UMTS 2100.

If there is a mobile phone connected to the telephone management system through the Bluetooth® »» **page 227** Hands-Free-Profile (HFP), you can make phone calls with the hands-free system.

For the connection to the aerial of the vehicle, the mobile phone must be on the lodging surface »» **Fig. 232** ①.

If the mobile phone does **not** connect, take into account the instructions to use a mobile telephone in the vehicle without connection to the external antenna »» **page 346**.

The location of the mobile phone lodging surface to use the comfort phone service depends on the vehicle in question.

Special characteristics

Take into consideration the following aspects in order not to hinder the connection of the phone to the aerial of the vehicle.

- The dimensions of the mobile phone must not exceed 120 x 67 mm.
- Only one mobile phone can be placed on the lodging surface ①.
- Place the mobile phone without a protection cover or case on the lodging surface.
- Do not place metallic objects (e.g. keys, coins, etc.) on the lodging surface.

Connection to the external antenna of the car


Take into account the particular characteristics to connect to the external antenna of the vehicle.

- If necessary, open the armrest.
- Place the mobile phone on the lodging surface ① (the rear part of the mobile phone must rest on the lodging surface).

If the mobile phone has been placed correctly, the antenna of the mobile phone will automatically connect to the external antenna of the vehicle. »


An additional antenna amplifier guarantees the quality of the connection.

USB Port

Depending on the features, there may be a USB port  in the lodging surface area in which USB devices can be charged (e.g. mobile phones or Media players).

The **maximum** charging capacity is 1.6 A.

Depending on the features, the USB devices connected can also be used as audio sources »» page 203.

- Connect the desired USB device via a cable compatible with the USB port .

The charging process is automatically interrupted when turning off the ignition or taking the key off the ignition.

Compatible charging cables can be purchased from SEAT dealers.

Driving

Start and driving

Starting and stopping the engine

Ignition lock

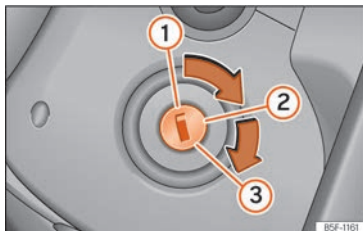


Fig. 233 Ignition key positions.

Key positions »» Fig. 233

- ① Ignition off. Key can be removed from the vehicle.
- ② Ignition is switched on.
- ③ Starting the engine.

Locking and unlocking the steering wheel

- Lock the steering wheel: remove the key from the ignition and turn the wheel until it

locks. Depending on the country, in vehicles with automatic transmission, in order to remove the key, move the gear shift to the **P** position. If necessary, press the gear shift blocking key and release it.

- Unlock the steering wheel: put the key into the ignition and turn it at the same time as the steering wheel in the direction indicated by the arrow. If it is not possible to turn the steering wheel, it may be because it is locked.

Start-Stop system

If the vehicle is stopped and the Start-Stop system switches off the engine, the ignition remains switched on.

Automatic transmission: before leaving the vehicle, make sure that the ignition is switched off and the selector lever is in position **P**.

⚠ WARNING

- Always remove the key from the ignition when leaving the vehicle, even if only for a short period. This is especially important if children or disabled people are left alone in the vehicle. They could accidentally start the engine or operate electrical equipment, resulting in an accident.
- The ignition key must NOT be removed from the lock until the vehicle comes to a standstill. Otherwise, the steering could be immediately blocked- Risk of accident!

i Note

- If it is difficult to turn the ignition key to the position ②, move the steering wheel to both sides to release the steering lock.
- If the vehicle battery is disconnected and reconnected, the key must remain in the position ② for around 5 seconds before starting up.
- Vehicles with automatic transmission, depending on the country, after switching off the ignition, you can only remove the ignition key if the selector lever is in position "P" [parking lock]. Next, the selector lever is locked.

Ignition and start button



Fig. 234 In the centre console: Start button of the Keyless Access locking and starting system. The layout in right-hand drive vehicles is symmetrical. »


The engine can be started with a start button (Press & Drive). To do so, there must be a valid key inside the vehicle in the area of the front or rear seats, or on the centre console.

In vehicles with the Keyless Access


»» **page 95** system, the engine can also be started with the key in the luggage compartment.

Opening the driver's door **when exiting the vehicle** activates the electronic lock on the steering column if the ignition is disabled.

Switching the ignition on/off manually

If you only want to switch on the ignition (without starting the engine), briefly press the start button once **without pressing** the brake pedal or the clutch pedal »» .


Automatic ignition disconnection

If the driver leaves the vehicle, taking the key with them but leaving the ignition on, the ignition does not switch off automatically. The ignition is switched off by pressing the lock button on the remote control  or by pressing the sensor surface on the door lever »» **Fig. 92**.

Automatic deactivation of the ignition on vehicles with the Start-Stop system

The ignition is switched off automatically when the vehicle is stopped and the automatic engine shutdown is active, if:

- The driver's seat belt is not fastened,
- the driver does not step on any pedal,
- the driver door is opened.

After automatically turning off the ignition, if the dipped beam  is on, the side light remains on for approx. 30 minutes (if there is enough charge in the battery). If the driver locks the vehicle or manually turns off the light, the side light goes out.

Engine restart feature

If no key is detected inside the vehicle after the engine stops, you will only have 5 seconds to restart it. A warning will display on the dash panel screen.

After this interval, it will not be possible to start the engine without a valid key inside the vehicle.

WARNING

When switching on the ignition, do not press the brake or clutch pedal, otherwise the engine could start immediately.



WARNING

If vehicle keys are used negligently or without due care, this may cause accidents and serious injury.

- **Never leave any key inside the vehicle when you leave it. Otherwise, a child or unauthorised person could lock the vehicle,**

start the engine or connect the ignition and operate any of the electrical equipment.

Note

- **Before leaving the vehicle, always disconnect the ignition and, if appropriate, take into account the instructions on the screen of the dash panel.**
- **If the vehicle is stationary for a long time with the engine off and the ignition on, the vehicle battery might be discharged and it might not be possible to start the engine.**
- **If during the STOP phase you press the  button, the ignition is switched off and the button flashes.**
- **If the indication is displayed on the instrument panel display "Start-Stop system deactivated: Start the engine manually"; the  button will flash.**

Starting the engine

Before starting the engine

- *Vehicles with manual gearboxes:* put the gear lever in neutral, press the clutch pedal and keep it in this position until the engine starts.
- *Vehicles with automatic transmission:* put the lever in position **P** or **N**.

Vehicles with ignition locks

- Turn the key to position »» Fig. 233 ②.
- Keep turning the key to position »» Fig. 233 ③ without stepping on the accelerator.
- Once the engine starts, release the key. When it is released, the key returns to position ②.
- If the engine does not start, stop and wait for around 1 minute to try again.

Vehicles with start buttons

- Press and hold the brake pedal until the engine starts.
- Press the starter button »» Fig. 234; do not press the accelerator. There needs to be a valid key inside the vehicle for the engine to start.
- Once the engine starts, release the start-up button.
- If the engine does not start, stop and wait for around 1 minute to try again. If necessary, perform an emergency start »» page 244.

WARNING

Do not keep the engine running in confined spaces, as there is a danger of poisoning.

- The exhaust gases contain carbon monoxide, an odourless and colourless poisonous gas that can cause loss of consciousness and death.

WARNING

Do not get out of the vehicle with the engine running, especially if a gear is engaged. The vehicle could then suddenly move or something strange could happen that would cause damage, fire or serious injury.

WARNING

Never use cold start sprays, they could explode or cause the engine to run at high revs. Doing this risks injury.

CAUTION

- The starter motor or the engine may be damaged if you try to start the engine while driving or if you restart it immediately after switching it off.
- When the engine is cold, you should avoid high engine speeds, driving at full throttle and over-loading the engine. Risk of engine damage.


For the sake of the environment

Do not warm-up the engine by running the engine with the vehicle stationary. Start off immediately, driving gently. This helps the engine reach operating temperature faster and reduces emissions.

Note


- Electrical components with a high power consumption are switched off temporarily when the engine starts.
- When starting with a cold engine, noise levels may briefly increase. This is quite normal, and no cause for concern.

Turning off the engine

- Bring the vehicle to a full stop »» .
- With manual transmission, press the clutch all the way down. If the vehicle is automatic, set the selector lever to the P position.
- Apply the electronic parking brake.
- Vehicles with ignition locks: Turn the key to position »» Fig. 233 ①.
- Vehicles with start buttons: Briefly press the start-up button »» Fig. 234.

Emergency disconnection

If the engine does not switch off after briefly pressing the starter button, an emergency disconnect will be required:

- Press the starter button twice within 3 seconds or press it once for more than 1 second »»  in Ignition and start button on page 242.

»

⚠ WARNING

Never switch off the engine while the vehicle is moving. This could cause loss of control of the vehicle, accidents and serious injury.

- The airbags and belt tensioners do not work when the ignition is switched off.
- The brake servo does not work with the engine off. Therefore, you need to press the brake pedal harder to brake the vehicle.
- Power steering does not work when the engine is not running. You need more strength to steer when the engine is switched off.
- If the ignition is switched off, the steering column could be locked, making it impossible to control the vehicle.
- Never remove the key from the ignition if the vehicle is in motion. Otherwise, the steering could suddenly lock, making it impossible to steer the vehicle: risk of accident!

⚠ WARNING

Always take the key with you when you leave the vehicle. This is particularly important if there are children in the vehicle, as they might otherwise be able to start the engine or use power-operated equipment [e.g. the electric windows], which could cause injuries.

⚠ CAUTION

- If the vehicle is stopped and the Start-Stop system switches off the engine, the ignition remains switched on. Make sure that the ignition is switched off before leaving the vehicle, otherwise the battery could discharge.
- If the engine has been driven at high speed for a prolonged period of time, it may overheat when turned off. To avoid engine damage, allow the engine to run for approximately two minutes in neutral before switching it off.

i Note

After the engine is switched off the radiator fan may run on for up to 10 minutes, even if the ignition is switched off. It is also possible that the fan turns itself on once more if the coolant temperature increases due to the heat accumulated in the engine compartment or due to its prolonged exposure to solar radiation.

Electronic immobilizer

The electronic immobiliser prevents unauthorised persons from driving the vehicle.

Inside the key there is a chip that deactivates the electronic immobiliser automatically when the key is inserted into the ignition.

The electronic immobiliser will be activated again automatically as soon as you pull the key out of the ignition lock. For vehicles with the "Keyless Access" system, the key has to be outside the vehicle.

If the following message is shown on the instrument panel display: **SAFE** or **Immobiliser active**, it is not possible to start the vehicle.

The engine can only be started using a genuine SEAT key with its correct code.

i Note

A perfect operation of the vehicle is ensured if genuine SEAT keys are used.

Emergency starting function

Fig. 235 Emergency ignition in vehicles with Keyless Access.

If no valid key is detected inside the vehicle, an emergency start-up will be required. The relevant message will appear in the dash panel display. This may happen when, for example, the vehicle key battery is very low:

- Immediately after pushing the starter button, keep the key next to the right trim of the steering column »» Fig. 235, as close as possible to the Kessy logo.
- The ignition connects and the engine starts automatically.

Start-Stop system

Control lamps

It lights up

The Start-Stop system is available, the automatic engine shutdown is active.

It lights up

The Start-Stop system is not available or has been disconnected.

Description and operation

The Start-Stop system helps you to save fuel and reduce CO₂ emissions.


In Start-Stop mode, the engine will automatically switch off when the vehicle stops or is stopping. The ignition remains switched on. The engine automatically switches back on when required.

When the ignition is switched on, the Start-Stop function is automatically activated.

Vehicles with a manual gearbox

- When the vehicle is at a standstill, leave it in neutral and take your foot off the clutch. The engine switches off.
- Simply depress the clutch pedal to move off again.

Vehicles with an automatic gearbox

- Brake until the vehicle has come to a standstill, and keep your foot on the brake pedal or activate the Auto Hold system so that the vehicle remains braked. The engine will switch off. The warning lamp  will appear in the display. The engine can be stopped before stopping completely (approximately 7 or 2 km/h depending on the vehicle's gearbox).
- When you take your foot off the brake pedal the engine will start up again. The warning lamp will switch off. In vehicles with the Auto Hold system, when the system is active, the engine will not start if you remove your foot from the brake pedal. The car starts when you press the accelerator pedal.

Basic requirements for the Start-Stop mode



- The driver door must be closed.
- The driver's seat belt must be fastened.
- The bonnet must be closed.
- The engine has reached operating temperature.
- The reverse gear must not be engaged.
- The vehicle must not be on a very steep slope.

The engine does not turn off for various reasons

Before stopping the vehicle, the system verifies whether certain conditions are met. The engine **does not** switch off, in the following situations for example:

- The engine has not yet reached the required temperature for the Start-Stop mode.
- The temperature selected on the climate control has not been reached.
- The interior temperature is very high/low.
- Defrost function button activated »» page 161.
- Park assist is switched on.
- The battery is very low.
- The steering wheel is overly turned or is being turned.
- If there is a danger of misting. »

- After engaging reverse gear.
- In case of a very steep gradient.

 is displayed on the instrument cluster screen; it is also displayed in the driver information system, START  STOP.

The engine starts by itself

When stopped, the normal system mode may be interrupted in the following situations. The engine restarts by itself without involvement from the driver.

- The interior temperature differs from the temperature selected on the climate control.
- Defrost function button activated »» page 161.
- The brake has been pressed several times consecutively.
- The battery is too low.
- High power consumption.

Additional information related to the automatic gearbox

The engine stops when the selector lever is in the positions **P**, **D**, **N** and **S** in addition to when in Tiptronic mode. With the selector lever in **P**, the engine will also remain switched off when you take your foot off the brake pedal. In order to start the engine up again the accelerator must be pressed, or another gear engaged or the brake released.

If the selector lever is placed in **R** while stopped, the engine will start up again.

Change from **D** to **P** to prevent the engine from accidentally starting when passing through **R**.

Additional information about vehicles with Adaptive Cruise Control (ACC)

In vehicles with ACC function, the engine will start up again in certain operating conditions if the radar sensor detects that the vehicle ahead drives off again.

WARNING

- **Never switch the engine off until the vehicle is stationary. The operation of the brake and steering will not be fully guaranteed. More force will be needed to turn the steering wheel or to brake. You could suffer an accident and even serious injuries.**
- **To avoid injury, make sure that the Start-Stop system is switched off when working in the engine compartment »» page 247.**

CAUTION

The Start-Stop system must always be switched off when driving through flooded areas »» page 258.

Note

- **In vehicles with an automatic gearbox, you can control whether the engine should**

switch off or not by reducing or increasing the brake force applied. While the vehicle remains stopped, the engine will not stop if the brake pedal is slightly pressed, in traffic jams with frequent stopping and starting for example. As soon as strong pressure is applied to the brake pedal, the engine will stop.

- **When stopped, the brake pedal must be kept pressed to ensure that the vehicle does not move.**
- **If the engine “stalls” with a manual gearbox, it can be directly started up again by immediately pressing the clutch pedal.**
- **With an automatic gearbox, if the lever is placed in position D, N or S after engaging reverse gear, 10 km/h (6 mph) in a forwards direction must be reached for the system to be in a status to stop the engine.**

Manually connecting and disconnecting the Start-Stop system

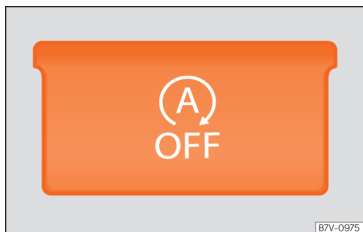


Fig. 236 Detailed view of the centre console: Start-stop operation button.

If you do not wish to use the system, you can switch it off manually.

- To manually switch on/off the Start-Stop system, press the  button »» Fig. 236.

The button will light up when the Start-Stop function is switched off.

Note

The system switches on every time the engine is turned off voluntarily.

Manual gearbox

Changing gears

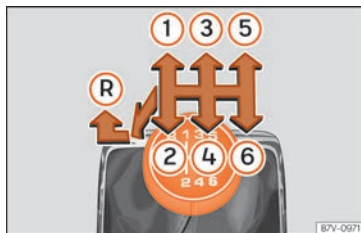


Fig. 237 Gear shift pattern of a 6-speed manual gearbox

The position of the gears is indicated on the gearbox lever »» Fig. 237.

- Press the clutch pedal and keep your foot right down.
- Move the gearbox lever to the required position.
- Release the clutch.

Selecting reverse gear

Engage reverse gear only when the vehicle is stopped.



- Press the clutch pedal and keep your foot right down.

- With the gearbox lever in neutral, push it downwards, move it to the left as far as it will go and then forwards to select reverse

»» Fig. 237 .

- Release the clutch.

Changing down gears

While driving, changing down a gear must always be done gradually, i.e. to the gear directly below and when the engine speed is not too high »» . Changing down while bypassing one or various gears at high speeds or at high engine speeds can damage the clutch and the gearbox, even if the clutch pedal remains depressed »» .

WARNING

When the engine is running, the vehicle will start to move as soon as a gear is engaged and the clutch released. This also happens if the electronic parking brake is switched on.

- Never engage reverse gear when the vehicle is moving.

WARNING

If the gear is changed down inappropriately by selecting a gear that is too low, you may lose control of the vehicle, causing an accident and serious injuries. »»

ⓘ CAUTION

When travelling at high speeds or at high engine speeds, selecting a gear that is too low can cause considerable damage to the clutch and the gearbox. This can also occur if the clutch pedal is pressed and held and it does not engage.

ⓘ CAUTION

To prevent damage and avoid premature wear, please observe the following:

- Do not rest your hand on the gear lever while driving. The pressure applied by your hand is transmitted to the gearbox selector forks.
- Do not leave your foot on the clutch pedal; although the pressure may seem insignificant, it can cause the premature wear of the clutch plate. Use the foot rest when you do not need to change gear.
- Always ensure that the vehicle is completely stopped before engaging the reverse gear.
- Always press the clutch to the floor when changing gears.
- Never hold the vehicle "on the clutch" on hills with the engine on.

Automatic gearbox/DSG automatic gearbox

Introduction

Your vehicle is equipped with an electronically controlled manual gearbox. Torque between the engine and the gearbox is transmitted via two independent clutches. They replace the torque converter found on conventional automatic gearboxes and allow for smooth, uninterrupted acceleration of the vehicle.

The **Tiptronic** system allows the driver to change gears *manually* » page 250, Changing gear in Tiptronic mode.

Control lamps

Ⓢ It lights up green

The brake is not pressed.
To select a gear range, press the brake pedal.

Ⓢ Flashes green

The selector lever locking button is not engaged.
The vehicle is prevented from moving forwards. Engage the selector lever lock.


Selector lever positions



Fig. 238 Automatic gearbox selector lever with locking button (arrow)


When the ignition is on, the current position of the selector lever is shown on the instrument panel.

P – Parking lock

When the lever is put in this position, the drive wheels are locked. The lever must only be put in **P** when the vehicle is *stationary* » .

To put the lever in **P** or take it out of **P**, the locking button must be pressed and held and the brake pedal pressed simultaneously.


R – Reverse gear

Reverse gear must be engaged only when the vehicle is *stationary* and the engine is idling » .

To move the lever to position **R**, the lock button must be pressed and held while pressing the brake pedal at the same time. The reverse lights come on when the lever is in the **R** position with the ignition on.

N – Neutral

With the lever in this position, the gear is in neutral.

Press the brake pedal to move the lever from **N** to **D/S** when the vehicle is stationary or at speeds below 3 km/h (2 mph) »» » .

D - Standard forward driving position (normal programme)


The gears are changed (up and down) automatically. The gear shifts are determined by the engine load, your individual driving style and the speed of the vehicle.

S - Standard forward driving position (sports programme)


The shift up to a higher gear is automatically *delayed* and the shift down is *faster* with respect to the **D** range of gears, to take full advantage of the engine power. The gear shifts are determined by the engine load, your individual driving style and the speed of the vehicle.

Selector lever lock

In **P** or **N**, the lever lock prevents a gear range from being engaged, and prevents the vehicle from moving off accidentally.

To release the gear lever lock, press and hold the brake pedal with the ignition on. At the same time, press the lever lock in the direction of the arrow »»  **Fig. 238**.

The lever is not locked if it is moved quickly through position **N** (e.g. when shifting from **R** to **D**). This makes it possible, for instance, to "rock the vehicle backwards and forwards" if it is stuck in snow or mud. The lever lock engages automatically if the brake pedal is not pressed and the lever is in position **N** for more than about one second at a speed of less than 5 km/h (3 mph).

In vehicles with a DSG® automatic gearbox, on rare occasions the lever lock may not engage. In this case, the transmission is locked to prevent the vehicle from moving accidentally. The green control light  flashes and an information text is displayed. Proceed as follows to engage the lever lock:

- Press the brake pedal and then release.

Safety interlock for ignition key

Once the ignition has been turned off, the key may be removed only if the gear selector is in position **P**. While the key is not in the ignition, the selector lever is locked in position **P**.

WARNING

- Take care not to press the accelerator pedal when the vehicle is stopped. The vehicle could start moving immediately (in some cases even if the parking brake is engaged) resulting in the risk of an accident.
- Never move the lever to **R** or **P** when driving. Failure to follow this instruction could result in an accident or failure.
- With lever in any position (except **P**), the foot brake must be pushed down whenever the engine is running. This is because an automatic gearbox still transmits power even at idling speed.
- While you are selecting a gear and the vehicle is stopped with the engine running, do not accelerate. Failure to follow this instruction could result in an accident.
- As a driver you should never leave your vehicle if the engine is running and a gear is engaged. Switch on the electronic parking brake and select the parking lock (**P**).

Note

- If the lever is moved accidentally to **N** when driving, release the accelerator and let the engine speed drop to idling before selecting gear range **D** or **S** again.
- Should the power supply to the lever be interrupted in position **P**, it will not be possible to move the lever. If this should happen the manual release can be used »» page 252.



Note

- Despite a gear being engaged, the vehicle does not move forwards or back. Proceed to the next mode:
 - When the vehicle does not move in the required direction, the system may not have the gear range correctly engaged. Press the brake pedal and engage the gear range again.
 - If the vehicle still does not move in the required direction, there is a system malfunction. Seek specialist assistance and have the system checked.

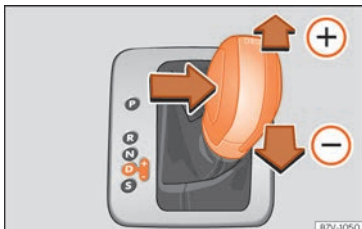
Changing gear in Tiptronic mode

Fig. 239 Selector lever in Tiptronic position (left-hand drive vehicles). The lay-out in right-hand drive vehicles is symmetrically opposed.

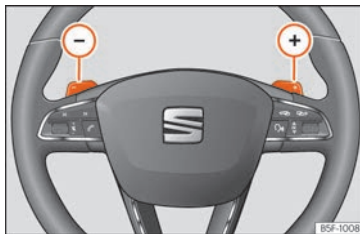


Fig. 240 Steering wheel with two paddle shifts for Tiptronic

Tiptronic gives the driver the option to change gears manually.

When you change to the Tiptronic programme, the vehicle remains in the currently selected gear. This is possible as long as the system is not changing gear automatically due to a traffic situation.

Using Tiptronic with the selector lever

It is possible to change to Tiptronic mode, both when the vehicle is stopped and while driving.

- Press the selector lever from position **D** to the right into the Tiptronic selector gate.
- Push the lever forwards (+) or backwards (-) to move up or down a gear »» Fig. 239.
- To exit Tiptronic mode, move the lever to the left.

Using Tiptronic with the steering wheel paddles

- In **D** or **S**, move the steering wheel paddle shifts »» Fig. 240.
- Press the gearshift paddle (+) to select a higher gear »» Fig. 240.
- Press the gearshift paddle (-) to select a lower gear.
- To exit the Tiptronic mode, pull the right-hand lever towards the steering wheel for approximately 1 second or move the lever to the left.

If the paddles are not operated for some time and the lever is not in the Tiptronic selection position, it will automatically exit from Tiptronic mode.

CAUTION

- When accelerating, if a higher gear is not selected, it will automatically change shortly before reaching the maximum permitted RPM.
- Also, if a lower gear is selected, the system will not change until it detects that the engine will not reach its maximum RPM.

Driving with an automatic gearbox

The gearbox changes gear ratios automatically as the vehicle moves.

The engine can only start with the selector lever in position **P** or **N**. At low temperatures, below $-10\text{ }^{\circ}\text{C}$ ($+14\text{ }^{\circ}\text{F}$), the engine can only start with the selector lever in position **P**.

Driving down hills

Under certain circumstances it may be advantageous to use the Tiptronic mode to select the gear manually according to driving conditions »» ⚠.

Stop/Park

On level ground, just use the lever to engage position **P**. On slopes you should first apply the parking brake and then set the lever to **P**. This makes it easier to remove the lever from position **P** when starting.

Stopping on a downhill

Always apply the brake pedal firmly to prevent the vehicle from moving; if necessary, apply the electronic parking brake »» ⚠.

Do not accelerate while a range of gears is engaged to prevent the car from rolling downhill »» ⚠.

Starting off uphill with the Auto Hold function

- Once you have engaged a gear, take your foot off the brake pedal and gently press the accelerator.

Starting off uphill without the Auto Hold function

- Pull on the electronic parking brake button.
- Once you have engaged a gear, gently press the accelerator and pull on the electronic parking brake button.

Back-up programme

If all the positions of the lever are shown over a light background on the instrument panel display, there is a system fault and the automatic gearbox will operate in with the backup programme. It is still possible to drive the vehicle, however, at low speeds and within a selected range of gears. **Driving in reverse gear may not be possible.**

6-speed DSG® automatic transmission overload protection

When the clutch is overloaded, the vehicle begins to *jerk* and the selector lever position indicator begins to flash. To prevent damage to the clutch, this interrupts the power transmission between the engine and the gearbox. There is no more traction and it is not possible to accelerate. If the clutch is opened automatically due to overloading, press the brake pedal. Wait a few seconds before starting to move again.

Kick-down

The kick-down system provides maximum acceleration when the gear selector lever is in the positions **D**, **S** or in the Tiptronic position.

When the accelerator pedal is pressed right down, the automatic gearbox will shift down to a lower gear, depending on road speed and engine speed. This takes advantage of the maximum acceleration of the vehicle »» ⚠.

The upshift to the next higher gear is delayed until the engine reaches maximum rpm.

⚠ WARNING

Observe the safety warnings »» ⚠ in Selector lever positions on page 249.

- Never allow the brake to rub and do not use the brake pedal too often or for long periods, as the brakes can overheat. This reduces the braking power, increases the braking distance or even causes a brake system fault.
- If you have to stop on a hill, keep the vehicle's brakes applied with the brake pedal or parking brake.

⚠ WARNING

Please note that if the road surface is slippery or wet, the kick-down feature could cause the driving wheels to spin, which could result in skidding. »»

ⓘ CAUTION

- If you stop the vehicle on a gradient, do not attempt to stop it from rolling by depressing the accelerator when a gear has been selected. This could cause overheating and damage the automatic gearbox.
- If you allow the vehicle to roll with the lever in position N and the engine off, the automatic gearbox will be damaged by lack of lubrication.
- If the gearbox operates with the backup programme, take the vehicle to a specialised workshop and have the fault repaired without delay.

Launch-control program

The Launch-control programme enables maximum acceleration from a standstill.

Condition: the engine must have reached operating temperature and the steering wheel must not be turned.

The engine speed for Launch-control is different on petrol and diesel engines.

- With the engine running, switch off traction control (ASR) » page 289.
- Press the brake pedal with your left foot and hold it down for at least one second.
- Place the selector lever in position **S** or Tip-tronic.

- Press the accelerator with the right foot until reaching an approximate speed of 3,200 rpm.
- Take your left foot off the brake pedal. The vehicle starts with maximum acceleration.
- Turn on the ASR after accelerating!

⚠ WARNING

- Always adapt your driving style to the traffic conditions.
- Only use the Launch control programme when road and traffic conditions permit, and make sure your manner of driving and accelerating the vehicle does not inconvenience or endanger other road users.
- Make sure that the ESC remains switched on. Please note that when the ASR and ESC are deactivated, the wheels may start to spin, causing the vehicle to lose grip. Risk of accident!

ⓘ Note

- After using the Launch control programme, the temperature in the gearbox may have increased considerably. In this case, the programme could be disabled for several minutes. The programme can be used again after the cooling phase.
- Accelerating with the launch control programme places a heavy load on all parts of the vehicle. This can result in increased wear and tear.

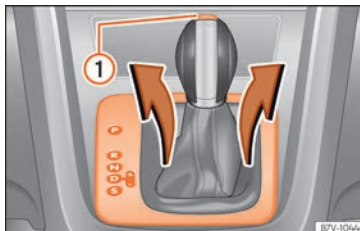
Manual release of the selector lever

Fig. 241 Remove the lining from the area of the gear indication

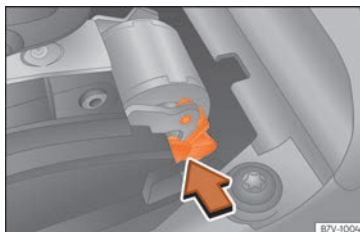





Fig. 242 Manual release of gear selector lever




In the event of a power failure when starting (e.g. discharged battery), the lever will remain locked in position **P**. To move it to position **N** to move the vehicle, there is an emergency release device under the centre console, on the

right side. Releasing the selector lever requires a certain degree of practical skill.

Removing the cover from the selector lever

- Apply the electronic parking brake  .
- Pull the cover up around the dust guard on the gear lever  **Fig. 241**.

Releasing the selector lever

- Press the release lever  **Fig. 242** in the direction of the arrow and hold it in this position.
- Press the lock button  **Fig. 241**  on the gear lever knob and place the gear selector lever in the **N** position.




WARNING

Do not move the lever from position P if the parking brake is not firmly engaged. If you still think the car could move, press the brake pedal. Danger! The vehicle could move in an unforeseen way and cause an accident or serious injury.


Gear-change recommendation

Selecting the optimal gear

Depending on the equipment on the instrument panel screen, a recommendation is shown with the gear that should be engaged to optimise consumption.

Display	Meaning
	Optimum gear.
	Recommendation to change up a gear.
	Recommendation to change down a gear.

Information regarding the "cleanliness" of the particulate filter

When the exhaust system detects that the particulate filter is close to saturation, this system's self-cleaning function recommends the optimal gear for that function  **page 314**.

WARNING

The gear change recommendation is an auxiliary function and in no case should be a substitute for careful driving.

- Responsibility for selecting the correct gear, depending on the circumstances, rests solely with the driver.

For the sake of the environment

Selecting the correct gear can help to save fuel.


Note

The recommended gear indication turns off when the clutch pedal is pressed or when the lever is removed from the tiptronic position.

Steering

Information relating to different vehicle processes.

Electro-mechanical power steering adapts *electronically* to the speed of the car, torque and steering angle.


Even if the power steering fails or the engine is stopped, it is possible to continue to rotate the steering wheel as long as the key remains in the ignition lock, but more force must be applied. 

Electronic steering column lock

Vehicles with Keyless Access: the steering column locks when the driver's door is opened and the ignition is switched off. Therefore, the vehicle should be at a standstill and, where applicable, the selector lever in position **P**.

If the driver door is opened before the ignition is switched off, the steering column electronic lock is activated via the ignition key or the sensor built into the door handle.

Steering assist

This help assists the driver in critical situations. It recommends turning the steering wheel to perform a corrective manoeuvre (counter-steering), turning slightly to avoid skidding »» .

WARNING

Steering assist helps the driver in critical situations. The driver is the person who has to control the vehicle's steering at all times.

Control lamp



It lights up red

Faulty steering.

Do not continue driving, stop the vehicle as soon as possible and in a safe manner.

Take the vehicle to a specialised workshop and have the fault repaired as soon as possible.



It lights up yellow

Limited steering operation.

Drive carefully to a specialised workshop to have the steering checked.

If the warning light does not come on again after re-starting the engine and driving a short distance, it is **not** necessary to check the steering.


OR: The 12-volt battery was disconnected and re-connected.

Drive a short distance at 15-20 km / h (9-12 mph).



Flashes red

Fault in the steering column electronic lock.

 **Do not continue driving!** Seek specialist assistance.



It flashes yellow

The steering column is jammed. When stopped, turn the steering wheel in both directions.

OR: The steering column does not unlock or lock. Remove the key from the ignition switch and reconnect it. Consider the messages shown on the instrument panel display.

Do not continue driving if the steering column remains locked after switching on the ignition. Seek specialist assistance.

The control lamp should light up for a few seconds when the ignition is switched on. It should go out once the engine is started.

WARNING

Never ignore the warning lamps or messages.

- **If the warning lamps and the corresponding messages are ignored, the vehicle may stall in traffic, causing serious damage or accidents and injuries.**
- **Stop the vehicle at the next opportunity and in a safe place.**

Dynamic chassis control (DCC)

Function and operation

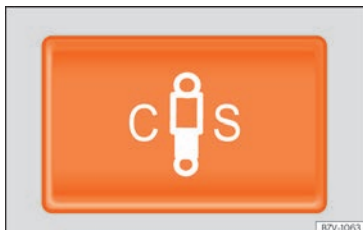


Fig. 243 In the centre console: button to adjust the adaptive suspension.

DCC continuously adapts the suspension to the condition of the road and current driving conditions, according to the pre-set programme.

Steering is also adapted in the "Sport" programme.

Programme	Driving recommendations
"COMFORT" C	Adjust it to the most comfortable setting, for example, driving on surfaces in poor condition, or making long trips.
"NORMAL"	Balanced setting, suitable, for example, for day-to-day use.

Programme	Driving recommendations
"SPORT" S	Sport setting for sporty style driving

Select a program

- Switch the ignition on.
- Press the **C S** button repeatedly until the desired program is displayed

The "NORMAL" programme is active when **neither the C nor S** buttons are lit up.

⚠ WARNING

Switching the dynamic chassis control system on while the vehicle is in motion could divert your attention from the traffic and cause accidents.

⚠ WARNING

Adjusting the suspension can change driving properties. Dynamic chassis control must never lead to any kinds of risk.

- **Adapt your speed and driving style at all times to suit visibility, weather, road and traffic conditions.**

i Note

If the dynamic chassis control does not operate as described in this chapter, go to an authorised workshop and request it be checked.

i Note

In the case of an adaptive suspension failure, the indications C and S light up on the button. The vehicle's comfort and driving may be affected by the fault. Have the system checked by a specialised workshop.

Driving tips

Running in

Please observe the instructions for running-in new components.

Running-in the engine

A new engine must be driven through a run-in period during its first 1500 kilometres (1000 miles). During its first few hours of running, the internal friction in the engine is greater than later on when all the moving parts have bedded down.

How the vehicle is driven for the first 1500 km (1000 miles) influences the future engine performance. Throughout the life of the vehicle, it should be driven at a moderate speed (especially when the engine is cold) this will reduce engine wear and increase its useful life. Never drive at extremely low engine speeds. Always engage a lower gear when the engine works "irregularly". **For the first 1000 km or 600 miles, please note:**



- Do not use full throttle.
- Do not force the engine above two thirds of its maximum speed.
- Do not tow a trailer.

Between 1000 and 1500 kilometres (600 to 1000 miles), gradually increase power until reaching the maximum speed and high engine speeds.

Running in new tyres and brake pads

- Replacement of wheel rims and new tyres »» page 329.
- Information about brakes »» page 283.



For the sake of the environment

If the engine is run in gently, the life of the engine will be increased and the engine oil consumption reduced.

Four-wheel drive (4Drive)

✓ Valid for vehicles: 4Drive all-wheel drive

On four-wheel drive models, the engine power is distributed to all four wheels

General notes

On four-wheel drive vehicles, the engine power is distributed to all four wheels. The distribution of power is controlled automati-

cally according to your driving style and the road conditions. Also see »» page 288.

The four-wheel drive is specially designed to complement the superior engine power. This combination gives the vehicle exceptional handling and performance capabilities, both on normal roads and in more difficult conditions, such as snow and ice. Even so (or perhaps especially for this reason), it is important to observe certain safety points »» ⚠.

Winter tyres

Thanks to four-wheel drive, your vehicle will have plenty of traction in winter conditions, even with the standard tyres. Nevertheless, we still recommend that winter tyres or all-season tyres be fitted on all four wheels to give even better *braking response*.

Snow chains

On roads where snow chains are mandatory, this also applies to cars with four-wheel drive »» page 334.

Changing tyres

On vehicles with four-wheel drive, all four tyres must have the same rolling circumference. Also avoid using tyres with varying tread depths »» page 329.

Off-roader?

Your SEAT vehicle is not an off-roader: it does not have enough ground clearance to be used as such. It is therefore best to avoid rough tracks and uneven terrain as much as possible.

⚠ WARNING

- Even with four-wheel drive, you should always adjust your speed to suit the conditions. Do not let the extra safety features tempt you into taking any risks when driving. Risk of accident!
- The braking capability of your vehicle is limited by the tyres' grip. It is therefore no different from a car without four-wheel drive. So do not be tempted to drive too fast on firm or slippery roads just because the vehicle still has good acceleration in these conditions. Risk of accident!
- On wet roads bear in mind that the front wheels may start to "aquaplane" and lose contact with the road if the car is driven too fast. If this should happen, there will be no sudden increase in engine speed to warn the driver, as occurs with a front-wheel drive car. For this reason you should always choose a driving speed suitable for the road conditions. Risk of accident!

Economical and environmentally friendly driving

Fuel consumption, environmental pollution and wear to the engine, brakes and tyres all depend largely on driving style. Consumption can be reduced between 10-15% with an efficient driving type. The following section gives you some tips on lessening the impact on the environment and reducing your operating costs at the same time.

Active cylinder management (ACT®)

Depending on vehicle equipment, the active cylinder management (ACT®) may deactivate some of the engine cylinders if the driving situation does not require too much power.

The number of active cylinders can be seen on the instrument panel display. » page 71.

Foresight when driving

If you think ahead when driving, you will need to brake less and thus accelerate less. Take advantage of the inertia of the vehicle whenever possible, with a **gear engaged**. This takes advantage of the engine braking effect, reducing wear on the brakes and tyres. Emissions and fuel consumption will drop to zero.

Changing gear to save energy

An effective way of saving is to change *in advance* to a higher gear.

Manual transmission: shift up from first to second gear as soon as possible. Choosing the right gear enables fuel savings. Select the highest possible gear appropriate for the driving situation (the engine should continue functioning with cyclical regularity).

Automatic transmission: accelerate gradually and without reaching the “kick-down” position.

Avoid driving at high speed

Avoid travelling at your vehicle's top speed, whenever possible. Fuel consumption, emission of harmful gases and noise pollution multiply as speed is increased. Driving at moderate speeds will help to save fuel.

Reduce idling time

In vehicles with the Start-Stop system idling is automatically reduced. In vehicles without the Start-Stop system it is worth switching off the engine, for example, at level crossings and at traffic lights that remain red for long periods of time. When an engine has reached operating temperature, and depending on the cylinder capacity, keeping it switched off for a minimum of about 5 seconds already saves more than the amount of fuel necessary for restarting.

The engine takes a long time to warm up when it is idling. Mechanical wear and pollutant emissions are also especially high during this initial warm-up phase. It is therefore best to drive off immediately after starting the engine. Avoid running the engine at high speed.

Regular maintenance

Regular servicing helps in saving fuel even before the engine is started. A well-serviced engine gives you the benefit of **improved fuel efficiency** as well as maximum reliability and an enhanced resale value. A badly serviced engine can consume up to 10% more fuel than necessary.

Avoid short journeys

The engine and catalytic converter need to reach their optimal **operating temperature** in order to minimise fuel consumption and emissions.

A cold engine consumes a disproportionate amount of fuel. The engine reaches its working temperature after about four kilometres (2.5 miles), when fuel consumption will return to a normal level.

Check tyre pressure

Always make sure the tyres are inflated to the correct pressures » page 331 to save fuel. If the pressure is below half bar, fuel consumption may increase by 5%. Due to the greater »

rolling resistance, under-inflation **also** increases tyre wear and impairs handling.

Do not use **winter tyres** all year round as they increase fuel consumption by up to 10%.

Avoid carrying unnecessary loads

Given that every kilo of extra **weight** will increase the fuel consumption, it is advisable make sure that no unnecessary loads are being transported.

Since the luggage rack increases the **aero-dynamic drag** of the vehicle, you should remove it when not needed. At speeds of 100-120 km/h (62-75 mph), this will save 12% of fuel.

Save electrical energy

The engine drives the alternator, thereby generating electricity. This implies that any increase in power consumption also increases fuel consumption! For this reason, switch off any unneeded electrical devices. Devices that use a lot of electricity include the blower at a high setting, the rear window heating or the seat heating.

Note

- If you have the Start-Stop system, it is recommended that it should not be disconnected.

- It is recommended that you close the windows when driving at more than 60 km/h (37 mph).
- Do not drive with your foot resting on the clutch pedal, as the pressure can make the plate slip. This causes wear and can damage the clutch plate.
- Do not ride the clutch on a hill, use the brake. The fuel consumption will be lower and you will prevent the clutch plate from being damaged.
- Use the engine brake on downhill by changing to the gear that is best suited for the gradient. Fuel consumption will be "zero" and the brakes will not suffer.

Driving on flooded roads

To prevent damage to the vehicle driving on flooded roads, take the following into account:

- The water should never come above the lower edge of the bodywork.
- Drive at pedestrian speed.

WARNING

After driving through flooded zones, braking effectiveness can decrease if the brake discs or pads are damp »» page 283.

CAUTION

- Driving through flooded areas may damage vehicle components such as the engine, transmission or electrical system.
- Whenever driving through water, the Start-Stop system must be switched off »» page 245.

Note

- Check the depth of the water before entering the flooded zone.
- Do not stop in the water, drive in reverse, or stop the engine.
- Vehicles travelling in the opposite direction cause waves that could exceed your vehicle's critical height.
- Avoid driving through salt water (corrosion) »» page 340.

Trips abroad

- With petrol vehicles, it should be ensured that lead-free petrol is available throughout the journey »» page 312, Fuel types. Seek information about service station networks selling unleaded fuel.
- In some countries, it is possible that your vehicle is not sold and some spare parts may not be available or the technical services may only be able to make limited repairs.

SEAT importers and distributors will provide information about the technical preparation that your vehicle requires and also about necessary maintenance and repair possibilities.

CAUTION

SEAT does not accept liability for any damage to the vehicle due to the use of a lower quality fuel, an inadequate service or the non-availability of genuine spare parts.

Driver assistance systems

General notes

Safety advice

WARNING

- Responsibility for driving rests with the driver at all times. The drive assist systems are not a replacement for driver attention. Focus all your attention on driving and be prepared to intervene at all times.
- Use the drive assist systems only when conditions allow. The driving style must always be suitable for the weather, visibility, road and traffic conditions.
- In order for drive assist systems to react correctly, sensors and cameras must operate without limitations. Please read the notes on sensors and cameras in this chapter.

Note

- Keep in mind the specific rules of each country, especially when it comes to driving, formation of an emergency corridor, braking distance, speed, parking position, wheel position, etc. The driver is solely responsible for always complying with the specific regulations of each country.
- The area in front of and around the radar sensor should not be covered with adhe-

sives, additional headlights or similar items, as this could have a negative impact on the operation of the assistants. If the vehicle is not properly repaired or structural modifications are made to it, the operation of the assistants may be affected.

- The repair and adjustment of sensors and cameras requires special knowledge and tools. It is recommended to visit a SEAT dealership for this purpose.

System limits

WARNING

- Drive assist systems can not overcome the laws of physics. Depending on the circumstances, a collision may not be avoidable.
- Warnings, notices and indicator lamps may not be displayed on time, or may be displayed incorrectly, e.g. if a vehicle approaches too quickly.
- Corrective interventions by drive assist systems (e.g. interventions in the steering or brakes) may be insufficient or may never occur, depending on the circumstances. As a driver, you must be prepared to act at all times.

»

Note

- Due to the system's detection limits in the surroundings, the systems may not give warnings or intervene on time, or they might do so even if it is not desired. In addition, the auxiliary systems may incorrectly interpret a manoeuvre and, as a result, warn the driver in an unexpected manner.
- When the towing mode is selected, some assist systems may react with limitations, in an unusual way or may not be available. Keep in mind the instructions relating to the towing mode.

Drive assist sensors and cameras

Front radar



Fig. 244 On the front bumper: radar sensors.

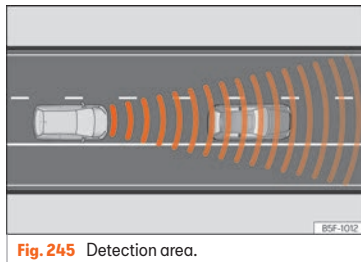


Fig. 245 Detection area.

A radar sensor may be fitted to the front bumper of the vehicle »» Fig. 244. The front radar detects any objects in its detection zone »» Fig. 245 and provides support for the following functions:

- Front Assist »» page 265.
- Adaptive Cruise Control (ACC) »» page 268.

The radar can have a range of up to 120m (400ft) depending on road and weather conditions.

WARNING

The visibility of the radar sensor can be impaired by dirt or environmental influences such as rain, fog, snow, mud, dust, insects etc. In this case the Front Assist and ACC functions may stop working. The instrument panel displays the following message: No sensor vision! And the Front Assist un-

available or ACC unavailable warning lights come on.

- Clean the sensor area on the bumper as indicated in »» page 342, Cleaning the exterior. When the radar sensor starts correctly detecting again, the message disappears from the screen and the functions become available again.

CAUTION

- If the radar sensor is dirty or poorly adjusted, the Front Assist system may give unnecessary warnings and apply the brakes inappropriately.
- The operation of the radar can be affected by strong reflections of the emitted signal. This may occur, for example, in an enclosed car park or due to the presence of metallic objects (e.g. guard rails or sheets used in road works).
- The sensor may not be adjusted correctly if it receives an impact. This may compromise the system's efficacy or disconnect it. If you have the feeling that the radar sensor is damaged or adjusted incorrectly, switch off the Front Assist and ACC functions to avoid any damage. If this occurs have it adjusted.

Front camera

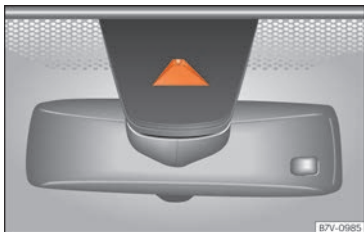


Fig. 246 On the windscreen: field of vision of the Lane Assist system.

Depending on the equipment, the vehicle may be fitted with a front camera on the front windscreen »» Fig. 246. This camera detects lane boundaries (lines) to provide support for the following functions:

- Lane Assist »» page 274.

ⓘ CAUTION

To avoid affecting the operation of the systems, take the following points into consideration:

- Clean the field of vision of the camera regularly and make sure it is free of snow and ice.
- Do not cover the field of vision of the camera.

- Check that the windscreen is not damaged in the area of the camera's field of vision.

Rear radar



Fig. 247 Rear view of the vehicle: radar sensor zones.

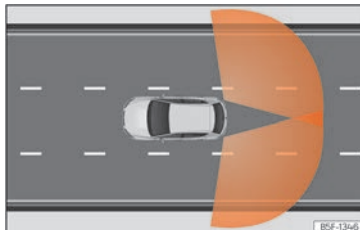


Fig. 248 Sensor detection zones

The radar sensors are located on the left and right of the bumper and are not visible from the outside »» Fig. 247. The sensors monitor both the blind spot and traffic behind the vehicle »» Fig. 248.

They support the following functions:

- Blind spot detector (BSD) »» page 278.
- Rear cross traffic alert (RCTA) »» page 281.

Automatic deactivation of supported functions

The rear radar sensors deactivate automatically when, among other reasons, one of the sensors is detected to be permanently covered. This may be the case if, for example, there is a layer of snow or ice over one of the sensors.

The relevant text message will appear in the dash panel display.

ⓘ CAUTION

- The radar sensors on the rear bumper may be damaged or shifted in the event of a collision, for example, when entering or exiting a parking space. This may result in the system disconnecting itself, or at least possibly having its functionality diminished.
- In order to ensure that the radar sensors work properly, keep the rear bumper free of snow and ice and do not cover it.

- The rear bumper should only be painted with paint authorised by SEAT. The lane departure warning's functions may be limited or work incorrectly if other paints are used.
- The visibility of radar sensors may be affected due to leaves, snow, strong haze or dirt, among others. Clean the area in front of the sensors.
- Never use the blind spot detector or the parking assistant if the radar sensors are dirty.

Ultrasound sensors

The bumpers are fitted with ultrasound sensors to perform the following functions:

- Park Assist »» page 290.
- Parking aid »» page 294

ⓘ CAUTION

- Damage to the radiator grille, bumper, wheel arch and vehicle underbody can modify the orientation of the sensors. This can affect the parking aid function. Have the function checked by a specialised workshop.
- A number plate or number plate holder with dimensions that exceed the space for the number plate, or a cured or deformed number plate can cause false detections or a loss of visibility for the sensors.

ⓘ Note

- In order to guarantee good operation, keep the sensors clean, free of snow and ice, and do not cover them with stickers or other objects.
- If you use high-pressure or vapour equipment for cleaning, do not apply it directly, unless you do so very briefly, and always keep a distance of more than 10 cm away.
- Fitting certain accessories to the front of the vehicle, such as a plate holder with advertising, may interfere with the operation of the Park Assist.

Rear View Camera



Fig. 249 In the rear bumper: location of the reverse assist camera.

A camera on the rear bumper aids the driver when reverse parking or manoeuvring. This provides support to the following function:

- Rear View Camera »» page 297.

⚠ WARNING

Fitting a number plate frame may interfere with the view shown on the screen, as it may reduce the camera's field of vision.

ⓘ CAUTION

- In order to guarantee good system operation, keep the cameras clean, free of snow or ice, and do not cover them with stickers or other objects.
- Never use abrasive cleaning products to clean the camera lens.
- Do not use hot or warm water to remove ice or snow from the camera lens. Doing so could damage the camera.

Cruise control system (CCS)

Control lamp

🚦 It lights up green

The Cruise Control System (GRA) is switched on and active.

The control lamps light up when the ignition is switched on and should turn off after approximately 2 seconds. This is the time taken for the function check.

⚠ WARNING

Observe the safety warnings »» ⚠ in Control and warning lamps on page 88.

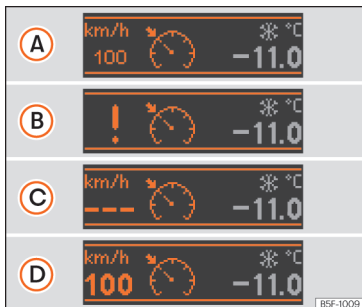
Introduction

Fig. 250 Instrument panel display: GRA status indications.

The cruise control system (CCS) is able to maintain the set speed from 20 km/h (15 mph).

The CSS only reduces vehicle speed by ceasing to accelerate, not by actively braking the vehicle »» ⚠.

Status display

There are different versions of the cruise control system. In vehicles with the multifunction display (MFD), the set speed is displayed on the instrument panel screen.

GRA status »» **Fig. 250**

- A** CCS temporarily switched off. The set speed is displayed in small or darkened figures.
- B** System error. Contact a specialised workshop.
- C** CCS switched on. The speed memory is empty.
- D** The CCS is switched on. The set speed is displayed in large figures.

Changing gear in CCS mode

The CCS decelerates as soon as the clutch pedal is pressed, intervening again automatically after a gear is engaged.

Travelling down hills with the CCS

If the CCS cannot maintain a constant vehicle speed downhill, brake and change down a gear if necessary. The GRA is temporarily disabled by pressing the brake.

Automatic off

The GRA disconnects automatically or is temporarily interrupted:

- If the system detects a fault that could affect the working order of the CCS.
- If you press and maintain the accelerator pedal for a certain time, driving faster than the stored speed.
- If the dynamic driving control systems intervene, ASR, ESC, etc.
- If the brake pedal is pressed.
- If the airbag is triggered.
- If the lever is taken out of the **D** or **S** position.
- If, in the case of a manual gearbox, 1st gear is engaged.
- If the clutch pedal is pressed for a long time.

⚠ WARNING

Use of GRA could cause accidents and severe injuries if it is not possible to drive at a constant speed maintaining the safety distance.

- **Do not use GRA in heavy traffic, if the distance from the vehicle in front is insufficient, on steep roads, with several bends or in slippery circumstances or on flooded roads.**
- **Never use the CCS when driving off-road or on unpaved roads.**

»

- Adapt your speed and the distance to the vehicles ahead in line with visibility, weather, the condition of the road and the traffic situation.
- To avoid unexpected operation of the cruise control system, turn it off every time you finish using it.
- It is dangerous to use a set speed which is too high for other conditions.
- If driving down a steep gradient, the GRA cannot maintain a constant speed. The speed can increase. In this case, brake and change down a gear.

Operating the cruise control



Fig. 251 On the left of the steering column: third lever for operating the GRA.

Connecting

- Move the lever towards the steering wheel to position **ON**.

If no speed has been programmed, the system will not control it.

Activating the cruise control

- Push button **SET** >>> **Fig. 251** ①.

The current speed is stored and the cruise control is activated.

Temporarily interrupting

- Move the lever to **CANCEL** and release it, or step on the brake.

The cruise control system is switched off temporarily. The speed is stored.

Reinstating the cruise control

- Move the lever to **RESUME** and release it.

Cruise control is activated at the stored speed.

Adjusting the speed

While the GRA is set, the stored speed can be adjusted:

- Move the lever to the pressure point **RESUME** to increase speed in small increments of 1 km/h (1 mph).
- Move the lever upwards **SPEED+** \oplus to increase in increments of 10 km/h (5 mph).
- Press the button **SET** >>> **Fig. 251** ① to reduce speed in small increments of 1 km/h (1 mph).

- Move the lever downwards **SPEED-** \ominus to reduce in increments of 10 km/h (5 mph).

To change the stored speed without interruption, keep the lever pressed in the direction **SPEED+** \oplus or **SPEED-** \ominus . The vehicle adapts the current speed by accelerating or stopping accelerating. The vehicle does not brake actively.

Switching off

- Move the lever to position **OFF**.

The system is disconnected and the memorised speed is deleted.

Emergency brake assistance system (Front Assist)

Introduction



Fig. 252 On the instrument panel display: advance warning indications.

The objective of the system is to prevent head-on collisions against objects that may be in the vehicle's path or minimise the consequences of such impacts.

Depending on several factors and how critical the situation is, the system operates in a staggered manner. First it warns the driver, and if the driver's reaction does not occur or is insufficient, it activates independent emergency braking.

The function is intended to prevent collisions with parked vehicles or vehicles in the same lane travelling in the same direction. **It may**

not activate in other hazard situations

»» ⚠

Front Assist is active between 4 km/h (2.5 mph) and 210 km/h (130 mph). Depending on a range of conditions, some of the functions described below are omitted to optimize the behaviour of the system.

Front Assist is a driving assistance function that can never replace the driver's attention.

Safety distance warning

If the system detects that you are driving too close to the vehicle in front, it will warn the driver with this indication on the instrument panel display 🚗🚗.

The timing of the warning varies according to other factors: driver behaviour and speed.

Advance warning

If the system detects a possible collision with the vehicle in front, it alerts the driver by means of an audible warning and an indication on the instrument panel display »» **Fig. 252.**

The warning moment varies depending on the traffic situation and driver behaviour. At the same time, the vehicle will prepare for a possible emergency braking »» ⚠.

Critical warning

If the driver fails to react to the **advance warning**, the system may actively intervene in the brakes and generate a brief jolt to warn the driver of the imminent danger of a collision.

Automatic braking

If the driver also fails to react to the **critical warning**, the system may initiate independent emergency braking by progressively increasing the braking in accordance with how critical the situation is.

Driver emergency brake assistance system

The system may detect that the driver is not braking hard enough to avoid the collision. In this case, it will increase the braking intensity.

The system cannot prevent a collision, although it can significantly minimise the consequences by reducing the speed and the force of the impact.

⚠ **WARNING**

Observe the safety warnings »» ⚠ in Control and warning lamps on page 88.

⚠ **WARNING**

Front Assist cannot change the laws of physics or replace the driver in terms of

»

keeping control of the vehicle and reacting to a possible emergency situation.

⚠ WARNING

Following a Front Assist emergency warning, pay immediate attention to the situation and try to avoid the collision as applicable.

- If the Front Assist does not work as described in this chapter (e.g. it repeatedly intervenes unnecessarily), switch it off. Have the system checked by a specialised workshop. SEAT recommends visiting a SEAT dealership.
- Always adapt your speed and distance away from the vehicle in front of you at all times to suit visibility, weather, road and traffic conditions.
- The Front Assist alone cannot avoid accidents and serious injuries.
- In complex driving situations, Front Assist may issue warnings and intervene in braking unnecessarily.
- If the operation of the Front Assist is impaired by dirt or because the radar sensor has lost its settings, the system may issue unnecessary warnings and intervene inopportunely in the braking.
- The Front Assist does not react to animals or vehicles crossing your path or approaching head-on down the same lane.

- The Front Assist does not react to pedestrians walking head-on in the same lane.
- The driver must always be ready to take over the control of the vehicle.

i Note

- When Front Assist is connected, the indications of other functions on the screen may be hidden.
- When the Front Assist causes a braking, the brake pedal is "harder".
- Automatic interventions by the Front Assist on the brakes may be interrupted by pressing the clutch, accelerator or moving the wheel.
- The Front Assist may brake the vehicle until it stops completely. However, the brake system does not halt the vehicle permanently. Use the foot brake!
- If the Front Assist does not work as described in this chapter (e.g. in intervenes several times unnecessarily), switch it off.

Operation of the emergency brake assistance system (Front Assist)



Fig. 253 On the instrument panel display: Front Assist deactivated indication.

The Front Assist is active whenever the ignition is switched on.

When the Front Assist is switched off, so too are the **advance warning** and the **distance warning** functions.


SEAT recommends leaving the Front Assist activated. Exceptions »» page 267, **Deactivating Front Assist temporarily** in the following situations.

Switching the Front Assist on and off

With the ignition switched on, the Front Assist can be deactivated or activated as follows:

- Select the corresponding menu option using the button for the driver assistance systems »» page 86.

• **OR:** using the instrument panel menu **Settings > Assistants > Front Assist**. To access the **Settings** menu, depending on the features, use the arrow keys and the wheel of the multi-function steering wheel or the button on the windscreen wiper lever »» page 85.

When Front Assist is deactivated, the indication  »» Fig. 253 will be displayed on the instrument cluster.

Activating or deactivating the pre-warning (advance warning)

The **advance warning** can be activated or deactivated in the instrument panel menu **Settings > Assistants > Front Assist** »» page 73.

The system will store the setting for the next time the ignition is switched on.

SEAT recommends keeping advance warning active.

Switching distance warning on and off

The distance warning can be activated or deactivated in the instrument panel menu **Settings > Assistants > Front Assist** »» page 73.

The system will store the setting for the next time the ignition is switched on.

SEAT recommends keeping the distance warning active.

Deactivating Front Assist temporarily in the following situations

In the following situations the Front Assist should be deactivated due to the system's limitations:

- When the vehicle is to be towed.
- If the vehicle is on a test bed.
- When the radar sensor is damaged.
- If the radar sensor receives a violent impact.
- If it intervenes several times unnecessarily.
- If the radar sensor is temporarily covered by an accessory.
- When the vehicle is going to be loaded onto transportation.

System limitations

Front Assist has certain limitations inherent to the system. Thus, in certain circumstances, some of the reactions may be inappropriate from the driver's standpoint. So pay attention in order to intervene if necessary.

The following conditions may cause the Front Assist not to react or to do so too late:

- In the first few instants of driving after switching on the ignition, due to the system's initial auto-calibration.
- If the Front Assist is switched off or damaged.
- If the radar sensor is dirty or covered.
- On taking tight bends or complex paths.
- Pressing the accelerator all the way down.
- If the ASR has been disconnected or the ESC activated in **Sport mode** »» page 289.
- If the ESC is controlling.
- If several brake lights of the vehicle or electrically connected trailer are damaged.
- If there are metal objects, e.g. guard rails or sheets used in road works.
- If the vehicle is reversing.
- In case of snow or heavy rain.
- In case of narrow vehicles, such as motor-bikes.
- Misaligned vehicles.
- Vehicles crossing the other's path.
- Vehicles approaching in the opposite direction.
- Loads and accessories of other vehicles that protrude over the sides, backwards or over the top.

ACC - Adaptive Cruise Control

Introduction

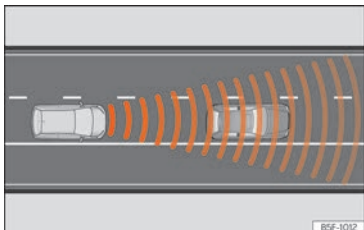


Fig. 254 Detection area.

The ACC is an extension of the vehicle's cruise control function (GRA) » » ⚠.

It allows the driver to set a cruise speed between 30 km/h (20 mph) and 160 km/h (100 mph) or 210 km/h (130 mph), and select the desired distance from the vehicle in front.

The ACC adapts the cruising speed of the vehicle, keeping a safe distance away from the vehicle in front, if there is one, depending on speed.

When driving behind another vehicle, the ACC reduces speed until it is the same as that of the vehicle ahead and maintains the set distance between the vehicles. If the vehi-

cle ahead accelerates, the ACC also accelerates the vehicle, going no higher than the programmed target speed.

If the vehicle is equipped with automatic gearbox, the ACC can brake the vehicle **until it stops completely** if a vehicle in front of it stops.

The distance programmed should be increased when the road surface is wet.

Driver intervention prompt

ACC is subject to certain limitations inherent to the system. In other words, in certain circumstances the driver will have to adjust the speed and the distance from other vehicles.

In this case, the instrument panel screen will warn you to intervene by applying the brake and a warning tone will be heard » » page 269.

⚠ WARNING

The ACC's technology cannot overcome the system's inherent limitations or change the laws of physics. If used negligently or involuntarily, it may cause serious accidents and injuries. The system is not a replacement for driver awareness.

- Adapt your speed and safe distance to the vehicle in front of you at all times to suit visibility, weather, road and traffic conditions.

- Do not use ACC in poor visibility, or on roads that are steep, with lots of curves or slippery.
- Never use ACC when driving off-road or on unpaved roads. The ACC has been designed for use on paved roads only.
- ACC does not react when approaching a fixed obstacle, such as the end of a traffic jam, a damaged vehicle or a vehicle stopped at the traffic lights.
- The ACC only reacts to people if a pedestrian monitoring system is available. The system does not react to animals or vehicles crossing your path or approaching head-on down the same lane.
- If the ACC does not reduce speed sufficiently, brake the vehicle immediately.
- If you are driving with a spare wheel fitted, the ACC system could automatically switch off. Switch off the system when starting off.
- If the vehicle continues to move involuntarily after a driver intervention prompt, brake the vehicle.
- If the instrument panel screen displays a driver intervention prompt, adjust the distance.
- The driver should be ready to accelerate or brake at all times.

Note

- If the ACC does not work as described in this chapter, do not use it until it has been checked by a specialised workshop. SEAT recommends visiting a SEAT dealership for this purpose.
- Maximum speed with the ACC activated is limited to 210 km/h (130 mph).
- When the ACC is switched on, strange noises may be heard during braking, caused by the braking system.

Symbols on the instrument panel display and control lamps



The speed reduction by the ACC to maintain the distance from the vehicle in front is not sufficient.

Brake! apply the foot brake! Driver intervention prompt.



ACC is not currently available^{a1}.

While the vehicle is stationary, switch off the engine and start it again. Check the area of the SEAT emblem on the front » Fig. 244. If it is still unavailable, refer to a specialised workshop to have the system inspected.

^{a1} The symbol on the instrument panels with colour display is in colour.



The ACC is active.

No vehicle is detected in front. The programmed speed remains constant.



If the symbol is white: the ACC is active.

A vehicle in front has been detected. The ACC adjusts speed and distance from the vehicle in front.



If the symbol is grey: ACC is inactive (Standby)

The system is switched on, but is not adjusting.



The lamp lights up green

The ACC is active.

Some control and warning lamps will light up briefly when the ignition is switched on to check certain functions. They will switch off after a few seconds.

WARNING

Observe the safety warnings » » in Control and warning lamps on page 88.

Status display

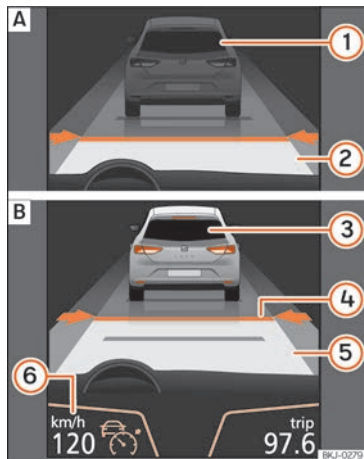


Fig. 255 On the instrument panel display: **A** ACC inactive (Standby). **B** ACC active.

Indications on the display » » **Fig. 255:**

- ① Vehicle ahead detected. ACC is not active and is not regulating your speed.
- ② Distance from the vehicle ahead. ACC is not active and is not regulating your distance.
- ③ Vehicle ahead detected. ACC is active and is regulating your speed. »

- 4 Distance level 2 set by the driver.
- 5 ACC is active and is regulating your distance based on speed.
- 6 Speed programmed with the ACC

Note

When the ACC is connected, the indications on the instrument panel screen may be concealed by warnings from other functions, such as an incoming call.

ACC operation

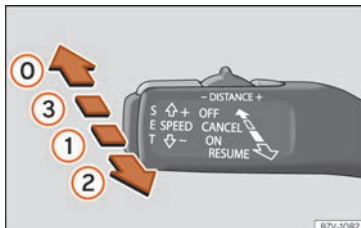


Fig. 256 On the left of the steering column: operating the ACC with the third lever.

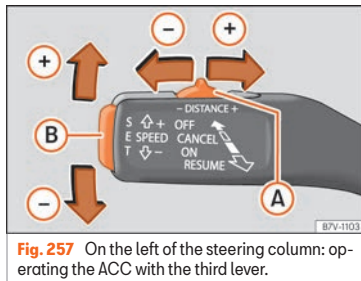


Fig. 257 On the left of the steering column: operating the ACC with the third lever.

When the ACC is connected, the green control lamp (ACC) will light up on the instrument panel, and the programmed speed and ACC status will be displayed » **Fig. 255**.

What ACC settings are possible?

- Connecting and activating the ACC » **page 270**.
- Setting your speed » **page 270**.
- Setting your distance » **page 271**.
- Disconnecting and deactivating the ACC » **page 271**.
- Adjusting the default distance level at the start of your journey » **page 271**.
- Adjusting the driving profile » **page 271**.
- Conditions in which the ACC does not react » **page 271**.

Connecting and activating the ACC

To connect and activate the ACC, the position of the gearbox lever, the vehicle speed and the position of the third level of the ACC must all be taken into account.

- With manual transmission, the gear lever must be in any gear except first. With automatic transmission, the gear lever must be in position **D** or **S**. Speed must be higher than 30 km/h [18 mph] approx.
- To activate the ACC, move the third lever to position **ON** » **Fig. 256** (1). At this time, the ACC is not active and there is no programmed speed.
- Next, press button **SET** » **Fig. 257** (B) or move the lever to position **RESUME** » **Fig. 256** (2). At this moment the ACC is activated and the current speed and distance are programmed. The picture in the box will change to Active mode » **Fig. 255** (B).

While ACC is active, the vehicle travels at a set speed and distance from the vehicle ahead. Both speed and distance can be changed at any time.

Setting speed

- To set the speed, move the third lever up (+) or down (-) to the desired speed » **Fig. 255** (6). The speed adjustment is made at 10 km/h [6 mph] intervals.

• If you wish to increase speed by intervals of 1 km/h [0.6 mph], move the lever to position **RESUME** »» Fig. 256 (2), or to decrease it press button **SET** »» Fig. 257 (B).

The set speed can be changed when the vehicle is stopped or during driving.

Setting your distance level

• To increase or reduce the distance, press button (A) to the right or left »» Fig. 257.

The instrument panel display modifies the selected distance »» Fig. 255 (4). There are 5 distance levels to choose from. SEAT recommends level 3. The set distance can be changed when the vehicle is stopped or while driving »» ⚠.

Disconnecting and deactivating the ACC

• To disconnect the ACC move the lever to position **OFF** (fixed) »» Fig. 256 (C). An **ACC deactivated** message appears and the function is totally deactivated.

If you do not wish to disconnect the ACC, just to switch it temporarily to inactive mode (Standby), move the third lever to position **CANCEL** (3) or press the brake pedal.

It will also switch to inactive mode (Standby) if the vehicle is stopped and the driver door is opened.

Adjusting the default distance level at the start of your journey

In wet road conditions, you should always set a larger distance with regard to the vehicle in front than when driving in dry conditions »» ⚠.

When connecting the ACC, the distance level can be preset to: Very short, Short, Medium, Long, Very long and Last distance. To access the **Settings** menu, depending on the features, use the arrow keys and the wheel of the multi-function steering wheel or the button on the windscreen wiper lever »» page 85.

Changing the driving profile

The driving profile can be used to modify the ACC acceleration and braking behaviour. There are three profiles available though the instrument panel menu at **Settings > Assistants > ACC > Basic settings**:

- Normal
- Sport,
- Eco

To access the **Settings** menu, depending on the features, use the arrow keys and the wheel of the multi-function steering wheel or the button on the windscreen wiper lever »» page 85.

The following conditions may lead the ACC not to react:

- If the accelerator is pressed.
- If there is no gear engaged.
- If the ESC is controlling.
- If the driver is not wearing his/her seat belt.
- If several brake lights of the vehicle or electrically connected trailer are damaged.
- If the vehicle is reversing.
- Driving faster than 210 km/h (130 mph).

⚠ WARNING

There is a danger of rear collision when the distance to the vehicle in front is reduced and the speed difference between both vehicles is so great that a speed reduction by the ACC is not sufficient. In this case, brake immediately!

- The ACC may not be able to detect all situations properly.
- Stepping on the accelerator may cause the ACC not to intervene in braking. Driver braking will have priority over intervention by the speed control or adaptive cruise control.
- Always be ready to use the brakes!
- Observe country-specific provisions governing obligatory minimum distances between vehicles.
- It is dangerous to activate control and resume the programmed speed if the road, »

traffic or weather conditions do not permit this. Risk of accident!

i Note

- The programmed speed is erased once the ignition or the ACC are switched off.
- When the anti-slip regulation (ASR) is disconnected while accelerating, the ACC disconnects automatically.
- In vehicles with the Start-Stop system, the engine switches off during the ACC stopping phase and restarts for moving off.

Deactivating the ACC temporarily in certain situations

In the following situations the ACC should be deactivated due to the system's limitations

»» **⚠**:

- When overtaking, on closed curves or mountain roads, roundabouts, slip roads or roadwork sections, preventing the system from accelerating to reach the programmed speed.
- When going through a tunnel, as operation could be affected.
- When other vehicles are going slower in the left lane. In this case, slower vehicles will be overtaken on the right.

- In case of heavy rain, snow or fog, the vehicle in front may not be detected.

⚠ WARNING

If the ACC does not switch off in the situations described, serious accidents and injuries may occur.

- Always switch off the ACC in critical situations.

i Note

If you do not switch off the ACC in the aforementioned situations, you may commit a legal offence.

Special driving recommendations

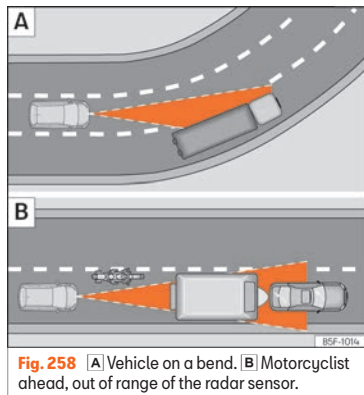


Fig. 258 **A** Vehicle on a bend. **B** Motorcyclist ahead, out of range of the radar sensor.

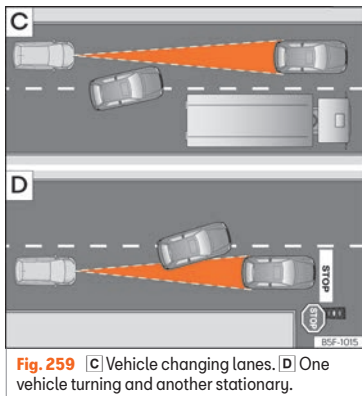


Fig. 259 [C] Vehicle changing lanes. [D] One vehicle turning and another stationary.

The ACC has certain limitations inherent to the system. Certain reactions, under certain circumstances, may be unexpected or come late from the driver's point of view. So pay attention in order to intervene if necessary.

The following situations require maximum attention:

Starting driving after a stopping phase (only with automatic transmission)

After a stopping phase, the ACC may begin driving when the vehicle in front moves off
» » »

Overtaking

When the turn signal lights up before the vehicle starts to overtake, the ACC accelerates the vehicle automatically and thus reduces the distance from the vehicle in front.

When the vehicle moves to the overtaking lane, if the ACC does not detect another vehicle in front, it accelerates until it reaches the programmed speed.

System acceleration can be interrupted at any time by pressing the brake or moving the third lever to position **CANCEL** » » » Fig. 256

Driving through a bend

When entering or leaving some curves, the radar sensor may cease to sense the vehicle driving in front of it, or react to a vehicle in the adjacent lane » » » Fig. 258 [A]. The vehicle may brake unnecessarily or stop reacting to the vehicle in front. In this case, the driver has to intervene by accelerating or interrupting braking by applying the brake or pushing the third lever to position **CANCEL** » » » Fig. 256

Driving in tunnels

When driving through tunnels the radar sensor may be limited. Switch off the ACC in tunnels.

Narrow or misaligned vehicles

The radar sensor can only detect narrow vehicles or vehicles that circulate out of alignment when they enter its range
» » » Fig. 258 [B]. In these cases, you should brake as necessary.

Vehicles with special loads and accessories

Special loads and accessories of other vehicles that jut out over the sides, backwards or over the top may be out of the ACC's range. SEAT recommends disconnecting it.

Other vehicles changing lanes

Vehicles changing lanes a short distance away from your own can only be detected when they are within range of the sensors. As a consequence, the ACC will take longer to react » » » Fig. 259 [C]. Brake yourself as necessary.

Stationary vehicles

The ACC does not detect stationary objects while driving, such as traffic tails or damaged vehicles.

If a vehicle detected by the ACC turns or moves over and there is a stationary vehicle in front of it, the ACC will not react to it
» » » Fig. 259 [D]. Brake yourself as necessary. » »

Vehicles driving in the opposite direction and vehicles crossing your path

The ACC does not react to vehicles approaching from the opposite direction or vehicles crossing your path.

Metal objects

Metal objects, e.g. guard rails or sheets used in road works, can confuse the radar sensor and cause the ACC to react wrongly.

Factors that may affect how the radar sensor operates

If laser sensor operation is impaired, due to heavy rain snow or mud, the ACC is deactivated temporarily. A message will be displayed stating this. If necessary clean the SEAT badge »» Fig. 244.

When the radar sensor begins to operate properly, the ACC will become available. The message will turn off and the ACC may be reactivated.

ACC operation may be affected by a strong radar reverse reflection, for example in a closed car park. SEAT recommends disconnecting it.

Trailer mode

When driving with trailer the ACC controls less dynamically.

Overheated brakes

If the brakes overheat, for example on long and steep descents, the ACC may be deactivated temporarily. A message will be displayed stating this. In this case, adaptive cruise control cannot be activated.

Cruise control may be reactivated once the brake temperature has dropped. The message will disappear. If the message **ACC not available** remains on for quite a long time it means that there is a fault. Contact a specialised workshop. SEAT recommends visiting a SEAT dealership.

WARNING

If you do not pay attention to the Press the brake message, the vehicle may move and crash into the vehicle ahead. Before driving off again, check that the road is clear. The radar sensor may not detect obstacles on the road. This could cause an accident and serious injuries. If necessary, apply the brake.

Lane Assist

Introduction

The Lane Assist System helps the driver stay in his/her lane within the physical limits of the system. This function is not suitable

for keeping the vehicle automatically in the lane, and it is not designed for this purpose.

Using the camera located in the windscreen, the Lane Assist system detects the possible lines dividing the lanes. When the vehicle involuntarily approaches a dividing line it has detected, the system notifies the driver with a *corrective steering movement*. The purpose is not only to warn the driver, but also to keep the vehicle inside the lane. This movement can be over-regulated at any time.

No warning is produced with the turn signals activated, given that the Lane Assist system understands that a lane change is required.

Control lamp

It lights up yellow

Lane Assist system active but not available. The system cannot accurately recognize the lane. See page 276, The lane assist system is active but it is not available (the control lamp is lit up yellow).

It lights up green

Lane Assist system active and available.

Some control and warning lamps will light up briefly when the ignition is switched on to

check certain functions. They will switch off after a few seconds.

⚠ WARNING

Observe the safety warnings »» ⚠ in Control and warning lamps on page 88.

Indications on the instrument panel display



Fig. 260 On the instrument panel display: Indication on the Lane Assist system display (example 1).

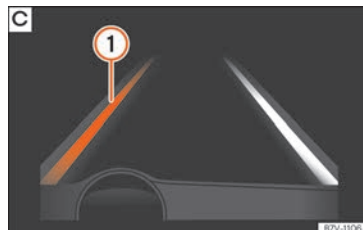


Fig. 261 On the instrument panel display: Indication on the Lane Assist system display (example 2).

Status display

- **Fig. 260 A:** The system is active, but not available, either because the minimum speed has not been reached or because the lane lines are not recognised.
- **Fig. 260 B:** The system is active and available, both lane lines are recognised. The steering angle is not being corrected at this moment.
- **Fig. 261 C:** The system is operational, the highlighted line ① indicates that there was a risk of involuntarily crossing the lane line and that the steering is being adjusted to correct the angle.

Operating mode

Steering wheel vibration

The following situations can cause vibration in the steering wheel and require the driver to take active control of driving:

- When the steering angle assist value required to keep the vehicle in the lane is higher than the system's maximum operating value.
- If the system ceases to display the lane lines while assisting with steering.

Switching the Lane Assist system on or off

- Select the corresponding menu option using the button for the driver assistance systems **»» page 86**.
- **OR:** using the instrument panel menu **Settings > Assistants > Lane Assist** **»» page 73**. The "confirmation sign" indicates that the driver assist system is switched on.

Automatic deactivation: the lane assist system can be deactivated automatically if there is a system malfunction. Control lamp switches off.

The lane assist system is active but it is not available (the control lamp is lit up yellow)


- When driving at speeds below 65 km/h [38 mph].

- When the Lane Assist system does not detect the dividing lines of the road. For example, in the event warnings indicating road works, and snow, dirt, moisture or reflections.
- When the radius of a curve is too small.
- When no road markings can be seen.
- When the distance to the next marking to too great.
- When the system does not detect any clear and active steering movement during a long period of time.
- Temporarily, in the event of very dynamic driving styles.
- If a turn signal is activated.
- When the ASR is switched off.

BSD Plus (Lane Assist with Blind Spot Assist)

The BSD Plus function is achieved by activating the Lane Assist and BSD functions **»» page 277**. In this case, the Lane Assist function expands its functions in the following way:

If the driver tries to change lane and there is a vehicle in the blind spot:

- The  lamp flashes in the corresponding rear-view mirror even though the turn signal has not been activated.
- The steering wheel vibrates to warn the driver of the risk of collision.

- torque is applied to correct the steering and return the vehicle to its lane.

Switching off the Lane Assist system in the following situations

Due to the limits of the Lane Assist system, switch it off in the following situations:

- When more attention is required of the driver
- When driving in a sporty style
- In unfavourable weather conditions
- On roads in poor condition
- In areas of road works

WARNING

The intelligent technology in the Lane Assist system cannot change the limits imposed by the laws of physics and by the very nature of the system. Careless or uncontrolled use of the Lane Assist system may cause accidents and injury. The system is not a replacement for driver awareness.

- Always adapt your speed and the distance to the vehicles ahead in line with visibility, weather conditions, the condition of the road and the traffic situation.
- Always keep your hands on the steering wheel so it can be turned at any time.
- The Lane Assist system does not detect all road markings. The road surfaces, road

structures or objects in poor condition can be incorrectly detected as road markings under certain circumstances by the Lane Assist system. In such situations, switch the Lane Assist system off immediately.

- Please observe the indications on the instrument panel and act as is necessary.
- Always pay attention to the vehicle's surroundings.
- When the area of vision of the camera becomes dirty, covered or is damaged, the Lane Assist system function can be affected.

ⓘ CAUTION

In order to avoid influencing the operation of the system, the following points must be taken into account:

- Regularly clean the area of vision of the camera and keep it in a clean state, without snow or ice »» Fig. 246.
- Do not cover the area of vision of the camera.
- Check that the area of vision of the wind-screen camera is not damaged.

ⓘ Note

- The lane departure warning system has been exclusively developed for driving on paved roads only.

- If the Lane Assist system does not work as described in this chapter, do not use it and contact a specialised workshop.
- If there is a fault in the system, have it checked by a specialised workshop.

Using the blind spot detector (BSD) with parking assistant (RCTA)

Introduction

The blind spot detector (BSD) helps to detect the traffic situation behind the vehicle.

The integrated parking assistant (RCTA) helps the driver when backing out of a parallel parking spot and in manoeuvring.

The blind spot detector has been developed for driving on paved roads.

⚠ WARNING

The smart technology incorporated into the blind spot detector (BSD) with parking assistance (RCTA) included cannot overcome the limits imposed by the laws of physics; it only works within the limits of the system. Accidents and severe injury may occur if the blind spot detection system or the rear cross traffic alert are used negli-

gently or involuntarily. The system is not a replacement for driver awareness.

- Adapt your speed and safe distance to the vehicle in front of you at all times to suit visibility, weather, road and traffic conditions.
- Keep your hands on the wheel at all times to be ready to intervene in the steering at any time.
- Pay attention to the control lamps that may come on in the external rear view mirrors and on the instrument panel, and follow any instructions they may give.
- The blind spot assistant could react to any special constructions that might be present on the sides of the vehicle: e.g. high or irregular dividers. This may cause erroneous warnings.
- Never use the blind spot detector with rear cross traffic alert on unpaved roads. The blind spot detector with rear cross traffic alert has been designed for use on paved roads.
- Always pay attention to the vehicle's surroundings.
- The external rear view mirror control lamps may have limited functionality due to solar radiation.

ⓘ Note

If the blind spot detector with parking assistant does not work as described in this



chapter, stop using it and contact a specialised workshop.

Control lamps



Control lamp in external rear view mirrors:


It lights up

It lights up once briefly: the blind spot detector is activated and ready to operate.



It lights up: blind spot detector has detected a vehicle in the blind spot.

Flashes

The blind spot detector has detected a vehicle in the blind spot and the turn signal has been turned on in the direction of the detected vehicle  .

For vehicles that are also equipped with Lane Assist  [page 274](#), a warning to switch lanes will also appear even though the turn signal has not been engaged.

The control lamps light up when the ignition is switched on and should turn off after approximately 2 seconds. This is the time taken for the function check.

If there are no indications from the control lamp in the external rear view mirror, this means that the blind spot detector has not detected any other vehicles in the area  .

If the dipped beam is on, then the control lamps in the external rear view mirrors will be dimmed (night mode).

WARNING

If the warning lamps and the corresponding messages are ignored when they light up, the vehicle may stall in traffic and cause accidents and severe injuries.

- Never ignore the warning lamps or messages.
- Carry out the necessary operations.

CAUTION

Failure to heed the control lamps and corresponding text messages when they light up may result in damage to the vehicle.

Blind spot detector (BSD)

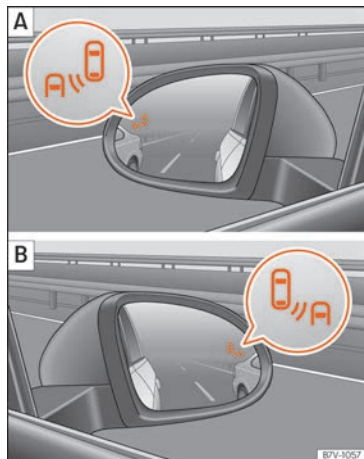



Fig. 262 In the exterior mirrors: blind spot detector indication.

The blind spot detector uses radar sensors to monitor the areas behind the vehicle  [page 261](#). The system does this by measuring the vehicle's distance from other vehicles and its speed differential. The blind spot detector will not work at speeds of less than approx. 15 km/h (9 mph). The system uses optical signals in the external rear view mirrors to notify the driver.

The lane width is not detected individually, but is rather pre-configured in the system. Thus if you are driving in wide lanes or in between two lanes, the indications may be incorrect. Furthermore, the system can detect vehicles driving in the lane next to you (if there are any), and can also detect stationary objects such as dividers, and thus give an incorrect indication.

Indication on the exterior mirror

The control lamp (expanded view) provides an indication in the corresponding external mirror »» **Fig. 262** regarding the traffic situation behind the vehicle, if it is deemed to be critical. The control lamp of the left-hand external mirror indicates the traffic situation to the left of the vehicle, and the control lamp of

the right-hand external mirror indicates the traffic situation to the right of the vehicle.

In the case of retrofitted tinted windows or windows with tinted film, the indications of the external mirrors may not be seen clearly or correctly.

Keep the external mirrors clean and free of snow and ice, and do not cover them with adhesives or other similar materials.

Driving situations

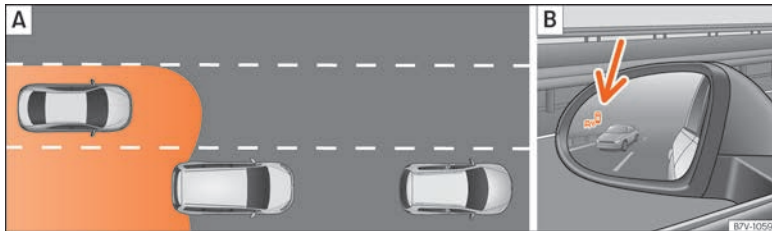


Fig. 263 Schematic representation: **A** Passing situation with traffic behind the vehicle. **B** Indication from the blind spot detector in the left-hand external mirror.

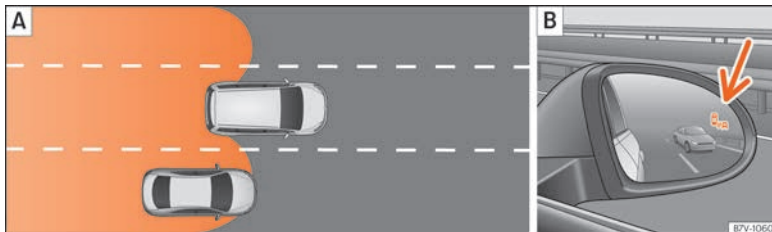


Fig. 264 Schematic representation: **A** Situation of passing and then moving into the right-hand lane. **B** Indication from the blind spot detector in the right-hand external mirror.

In the following situations, an indication will be displayed in the external mirror »» **Fig. 263** **B** [arrow] or »» **Fig. 264** **B** [arrow]:

- When being overtaken by another vehicle »» **Fig. 263** **A**.
- When passing another vehicle »» **Fig. 264** **A** with a speed differential of approx. 10 km/h (6 mph). If the vehicle is passing at a consid-

erably higher speed, no indication will be displayed.

The faster the vehicle approaches, the sooner an indication will be displayed in the external mirror, because the blind spot detector takes into account the speed differential with other vehicles. Thus even though the distance from the other vehicle is identical, the indication will appear sooner in some cases and later in others.

Physical limitations inherent to the system

In some situations the blind spot detector may not interpret the traffic situation correctly. E.g. in the following situations:

- on tight bends;
- in the case of lanes with different widths;
- at the top of slopes;
- in adverse weather conditions;

- in the case of special constructions to the side of the vehicle, e.g., high or irregular dividers.

Rear cross traffic alert (RCTA)



Fig. 265 Schematic representation of the rear cross traffic alert assistant: zone monitored around the vehicle while leaving a parking space.

Park Assist uses the radar sensors on the rear bumper » page 260 » Fig. 247 to monitor traffic crossing behind the vehicle as it reverses out of a parking bay, or as it is being manoeuvred, for example in very low visibility conditions.

If the system detects that someone else on the road is approaching the rear of the vehicle » Fig. 265, an acoustic alarm is heard.

- In vehicles without ParkPilot a “gong” will sound and a message will be displayed on the instrument panel.
- If the vehicle is equipped ParkPilot, the ParkPilot acoustic alarm will sound continuously.

Automatic braking to reduce damages

If the rear cross traffic alert detects that someone else on the road is approaching the rear of the vehicle and the driver does not step on the brake, the system will engage the brakes automatically.

The parking system helps the driver by automatically engaging the brakes to reduce any damage. The automatic intervention on the brakes takes place when driving in reverse at approx. 1-12 km/h (1-7 mph). After detecting that the vehicle is stationary, the system keeps it that way for around 2 seconds.

After automatically braking to reduce damage, the system will not be able to automatically brake again for approximately 10 seconds.

You can interrupt the automatic braking by stepping hard on the accelerator pedal or the brake pedal in order to regain control of the vehicle.

⚠ WARNING

The smart technology incorporated into the rear cross traffic alert cannot overcome the limits imposed by the laws of physics; it only works within the limits of the system. The parking assistant function should not tempt you into taking any risks. The system is not a replacement for driver awareness.

- The system should never be used in limited visibility conditions or complicated traffic, e.g., in high-traffic areas or when crossing multiple lanes.
- Be sure to always be aware of the vehicle's surroundings, since the system often fails to detect things such as bicycles or pedestrians.
- The rear cross traffic alert itself will not brake the vehicle to a complete stop.

Using the blind spot detector (BSD) with parking assistant (RCTA)

Activating and deactivating the blind spot detector (BSD) with parking assistant (RCTA)

The blind spot detector with parking assistant can be switched on and off by accessing the **Assistance systems** menu on the dash panel display using the steering wheel controls. If the vehicle is equipped with a multifunction camera, it can also be accessed by »

means of the driver assistance systems key located on the main beam headlight lever.

Open the **Assistants** menu.

- BSD
- Parking Assist.

If the verification box on the control panel is checked , the functionality will be automatically activated at ignition.

When the blind spot detector is ready to operate, the indications in the external mirrors will turn on briefly as confirmation.

When the vehicle is restarted, the last adjustment in the system will remain active.

If the blind spot detector was automatically deactivated, it will only be possible to restart the system after turning the vehicle off and restarting it.

Trailer mode

The Blind spot detector and the rear cross traffic alert will be automatically deactivated and it will be impossible to activate them if the tow hitch is electrically connected to a trailer or other similar object.

As soon as the driver starts to drive with a trailer connected electrically to the vehicle, a message will appear on the instrument panel display indicating that the blind spot detector and the rear cross traffic alert are deactivated. Once the trailer has been unhitched from

the vehicle, if you want to use the blind spot detector and the rear cross traffic alert, you will have to reactivate them in the corresponding menu.


If the towing hitch is not factory equipped, then the blind spot detector and the rear cross traffic alert will have to be deactivated manually when driving with a trailer.

Braking and parking



Braking system

Control lamps



It lights up red

Brake fluid level too low  page 323 or fault in the brake system.

 **Do not carry on driving!**


Together with the  control lamp on the button: Electronic parking brake on  page 285.

Flashes red

Electronic parking brake faulty. Simultaneously, the control warning light may light up , or the control lamp  on the button may flash.

Go to a specialised workshop, as you may not be able to park safely.

It lights up yellow

Along with the  warning lamp flashing: fault in the electronic parking brake.

Contact a specialised workshop.

It lights up yellow

Front brake pads worn.

Contact a specialised workshop immediately.

It lights up red




Brake pedal not pressed!
Fully depress the brake pedal.

It lights up green


Brake pedal not pressed.
Press the brake pedal to select a gear range.

Brake pedal not pressed.
Press the brake pedal to disengage the electronic parking brake »» page 285.

WARNING

- When the ignition is switched on, the status of the brake system and the brake assist functions is automatically checked. The control lights on the instrument cluster light up briefly and then turn off again. If a warning light stays on permanently, there is a fault. Seek qualified technical assistance immediately.
- If the brake warning lamp  does not go out or if it lights up when driving, the brake fluid level in the reservoir is too low so there is a risk of an accident »» page 323, Brake fluid. Stop the vehicle and do not drive on. Obtain technical assistance.
- If the brake warning lamp lights up  together with the ABS lamp  this could be due to an ABS fault. When this function fails, the rear wheels can lock up. Under certain circumstances, the rear of the vehi-

cle may skid, with the danger of losing control. Stop and seek technical assistance.

- If the  lamp lights up, alone or accompanied by a warning message on the instrument panel display, please go immediately to a specialised workshop to check the brake pads and to replace them if they are worn.

Information about the brakes

New brake pads

For the first 200 to 300 km (100 to 200 miles), new brake pads have not yet reached their maximum braking capacity, and need to be “run in” first. However, you can compensate for the slightly reduced braking effect by applying more pressure on the brake pedal. Avoid overloading the brakes while running them in.

Wear

The rate of wear on the **brake pads** depends a great deal on how you drive and the conditions in which the vehicle is operated. This is a particular problem in urban traffic and short stretches, or with very sporty driving.

Depending on the speed, the braking force and the environmental conditions (e.g. temperature, air humidity, etc.) noises may be produced when braking.

Wet roads or road salt


In certain situations (for example, on driving through flooded areas, in severe downpours or after washing the vehicle) the braking action could be delayed if the discs and pads are damp, or frozen in winter. In this case the brakes should be “dried” by pressing the brake pedal several times.

At high speed and with the windscreen wipers activated, the brake pads will briefly touch the brake discs. This takes place, although unnoticeable to the driver, at regular intervals to improve the response time of the brakes when they are wet.

The effectiveness of the brakes can also be temporarily reduced if the vehicle is driven for some distance without using the brakes when there is a lot of salt on the road in winter. The layer of salt that accumulates on the discs and pads can be removed by gently applying the brakes a few times.

Corrosion

There may be a tendency for corrosion to form on the discs and dirt to build up on the brake pads if the vehicle is used infrequently or the brakes are not used very often.

If the brakes are not used frequently, or if rust has formed on the disks, it is advisable to clean off the pads and disks by braking firmly a few times at a moderately high speed »»  »

Fault in the brake system

If the brake pedal travel should ever increase *suddenly*, this may mean that one of the two brake circuits has failed. Drive immediately to the nearest specialised workshop and have the fault repaired. Drive there slowly and remember that you will have to apply more pressure on the brake pedal and allow for longer stopping distances.

Low brake fluid level

Malfunctions can occur in the brake system if the brake fluid level is too low. The brake fluid level is monitored electronically.

Brake servo

The brake servo increases the pressure you apply to the brake pedal. It works only when the engine is running.

WARNING

Any anomaly in the brake system can increase the braking distance, with the resulting risk of an accident.

- New brake pads and discs must be run in and do not have the correct friction during the first 200 km (124 miles). This reduced braking capacity may be offset by pressing on the brake pedal a little harder.
- If you are driving on roads which have been salted, braking effectiveness may be decreased.

- Brakes can overheat if used excessively on slopes. Before driving down a long steep slope, it is advisable to reduce speed and change down into a lower gear or range. Therefore, using the engine brake relieves the brakes.

- Gentle continuous braking causes the brakes to overheat and the braking distance will increase. Apply and then release the brakes alternately.

- Apply the brakes heavily to clean the brake system only in a suitable traffic situation. Do not put other road users in danger: there is risk of causing an accident.

- Ensure the vehicle does not move while in neutral, when the engine is stopped. The braking distance is increased considerably when the brake servo is not active.

- If the brake is subjected to high stresses, vapour bubbles may form in the brake system's pipes. This reduces the efficiency of the brakes.

- Non-standard or damaged front spoilers could restrict the airflow to the brakes and cause them to overheat. Before purchasing accessories please read the relevant instructions.

CAUTION

- Never let the brakes "drag" by leaving your foot on the pedal when it is not necessary to brake. This overheats the brakes, re-

sulting in longer stopping distances and greater wear.

- Before driving down a long, steep gradient, it is advisable to reduce speed and select a lower gear. This makes use of engine braking and relieves the brakes. If you still have to use the brakes, it is better to brake firmly at intervals than to apply the brakes continuously.

Note

- If the brake servo is out of action, for example when the car is being towed, you will have to press the brake pedal considerably harder than normal to make up for the lack of servo assistance.

- If you wish to equip the vehicle with accessories such as a front spoiler or wheel covers, it is important that the flow of air to the front wheels is not obstructed, otherwise the brakes can overheat.

Electronic parking brake





Fig. 266 In the centre console: electronic parking brake button



The electronic parking brake replaces the handbrake.

Applying the electronic parking brake

The electronic parking brake can be activated whenever the vehicle is at a standstill, even when the ignition is switched off. Activate it whenever you leave or park the vehicle.

- Pull and hold the  **Fig. 266** button.
- The parking brake is activated when both the control lamp of button **Fig. 266** and the  control lamp on the instrument panel are both on.
- Release the button.


Disconnecting the electronic parking brake


- Switch the ignition on.
- Press the button  **Fig. 266**. At the same time step hard on the brake pedal or, if the engine is running, press the accelerator pedal slightly.
- The indicator lamp on button **Fig. 266** and the  indicator lamp on the instrument cluster turn off.

Automatic release of the electronic parking brake upon moving off

The electronic parking brake is automatically switched off when starting if, after the driver's door is closed and the driver's seat belt fastened, **any** of the following situations take place:



- In vehicles with automatic transmission: a gear range is engaged or the vehicle is switched to another one and the accelerator pedal is lightly pressed.
- In vehicles with manual transmission: the clutch pedal is pressed fully before starting off and the accelerator is pedal lightly pressed.
- To facilitate certain manoeuvres there are exceptions that allow the automatic parking brake to be released without the driver's seat belt being fastened.

The parking brake can be prevented from being automatically released by continuously pulling up the  **Fig. 266** switch when starting off.

The electronic parking brake is not disconnected until the  button is released. This can facilitate starting off when a heavy load is towed **page 301**.

Emergency brake function

Only use the emergency brake function if you are unable to stop the vehicle with the foot brake **▲**.

- Pull and hold the  **Fig. 266** button in this position to **forcefully** stop the vehicle. At the same time, an acoustic warning can be heard.
- To stop the braking process, release the  button or press the accelerator.

WARNING

The improper use of the electronic parking brake can cause accidents and serious injury.

- **Never use the electronic parking brake to stop the vehicle, unless it is an emergency. Braking distances can be considerably longer, since, under certain circumstances, only the rear wheels brake. Always use the foot brake.**

- **Never accelerate from the engine when a gear range or a gear is engaged and the** **»**

engine is running. The vehicle could move, even if the electronic parking brake is activated.

CAUTION

To prevent the vehicle from unintentionally moving when parking it, first apply the electronic parking brake and then remove your foot from the brake pedal.

Note

- In vehicles with a manual gearbox, releasing the clutch and accelerating at the same time automatically disconnects the electronic parking brake.
- If the vehicle battery is flat, it will not be possible to disconnect the electronic parking brake. Use the jump-start »» page 51.
- When the electronic parking brake is applied or released, noises may be heard.
- The system performs automatic and audible tests sporadically in the parked vehicle if some time elapses without the electronic parking brake being used.

Auto Hold Function



Fig. 267 Detailed view of the centre console: Auto Hold button

The control light of the **AUTO HOLD** »» **Fig. 267** button remains on when the Auto Hold function is connected.

Once connected, the Auto Hold function assists the driver in keeping the vehicle stationary at repeated intervals or for a certain period of time with the engine running, for example, when going up a slope, when stopped at traffic lights or in heavy traffic with intermittent stops.

When connected, the Auto Hold function automatically prevents the vehicle from rolling when stationary without pressing the brake pedal.

After detecting that the vehicle is stationary and the brake pedal has been released, the

Auto Hold function holds the vehicle. The driver can lift their foot off the brake pedal.

When the driver touches the accelerator pedal or accelerates slightly to continue driving, the Auto Hold function releases the brake. The vehicle moves according to the slope of the road.

If the vehicle is stationary and one of the conditions required by the Auto Hold function is impaired, it disconnects itself and the button's control light goes out »» **Fig. 267**. The electronic parking brake connects automatically, if necessary, to park the vehicle safely »» **△**.

Conditions for keeping the vehicle stationary with the Auto Hold function

- The driver door must be closed.
- The driver's seat belt must be fastened.
- The engine is running.

Switching the Auto Hold function on and off


Press the button **AUTO HOLD** »» **△**. The control lamp on the button goes out when the Auto Hold function is switched off.

Automatically engaging and disengaging the Auto Hold function

If the Auto Hold function was switched on with the **AUTO HOLD** button before disengaging the

ignition, the function will remain on after the ignition is re-engaged.

If the Auto Hold function was not switched on, it will automatically remain off next time the ignition is engaged.

The Auto Hold function connects automatically if the following conditions are met (all points must be met **at the same time** » ):

1. The vehicle is kept **stationary** with the brake pedal on a flat surface or on a slope.
2. The engine rotates "correctly".

The Auto Hold function is automatically turned off if the following conditions are met:

1. If any of the conditions mentioned on » page 286, **Conditions for keeping the vehicle stationary with the Auto Hold function** are no longer met.
2. If the engine is running irregularly or an anomaly is detected.
3. If the engine is turned off or stalls.
4. *Manual gearbox:* The clutch and the accelerator are pressed at the same time.
Automatic gearbox: If the accelerator is pressed
5. *Automatic gearbox:* If any of the tyres has only minimal contact with the

ground, e.g. in the case of axle articulation.

Permanent Auto Hold connection

The Auto Hold function must be switched on every time the engine is started. However, to switch the Auto Hold function on permanently, the "mark" must be switched on in the **Settings** menu, **Autohold** submenu » page 73.

WARNING

The smart technology incorporated into the Auto Hold function cannot defy the laws of physics; it only works within the limits of the system. The greater convenience provided by the Auto Hold function should never tempt you to take any risk that may compromise safety.

- Never leave the vehicle running and with the Auto Hold function switched on.
- The Auto Hold function cannot always keep the vehicle stationary uphill or downhill or stop it sufficiently, for example, on slippery or frozen surfaces.

Note

Before entering a car wash, always switch off the Auto Hold function, because if the electronic parking brake is automatically connected, it may cause damage.

Stabilisation and brake assistance systems

Control lamps

It lights up

Fault in the ESC or ABS, or disconnection caused by the system.
The ESC works in combination with the ABS. If the ABS fails, the lamp also lights up.




Flashes

ESC or ASR activated.

It lights up

ASR manually deactivated.

It lights up yellow

Along with the ESC control lamp : fault in the ABS.
Together with the warning lamp  or : ABS fault.

WARNING

When the ignition is switched on, the status of the brake system and the brake assist functions is automatically checked. The control lights on the instrument cluster light up briefly and then turn off again. If a warning light stays on permanently, there »

is a fault. Seek qualified technical assistance immediately.

Brake assist systems

Electronic Stability Control (ESC)

The ESC helps to improve safety. It reduces the tendency to skid and improves the stability and roadholding of the vehicle. The ESC detects critical handling situations, such as vehicle understeer or oversteer, or wheelspin on the driving wheels. It stabilises the vehicle by braking individual wheels or by reducing the engine torque. The warning lamp will flash on the instrument panel when the ESC is intervening.

The ESC includes the anti-lock brake system (ABS), the hydraulic brake assist (HBA), the traction control system (ASR), electronic differential lock (EDS), electronic torque control (XDS).

ESC also helps stabilise the vehicle by changing the torque.

The ASR can be deactivated when wheel spin is desirable » page 289.

Anti-lock brake system (ABS)

ABS prevents the wheels from locking up under braking until the vehicle has reached a virtual standstill. You can continue to steer the

vehicle even when the brakes are on full. Keep your foot on the brake pedal and do not pump the brakes. You will feel the brake pedal pulsate while the ABS is working.

If the running gear or brake system is modified, the effectiveness of the ABS could be severely limited.

Hydraulic Brake Assist (HBA)

The brake assist system can reduce the required braking distance. The braking force is automatically boosted if you press the brake pedal quickly in an emergency. You must keep pressing the brake pedal until the danger has passed.

Traction control system (ASR)

In the event of wheelspin, the traction control system reduces the engine torque to match the amount of grip available. This helps the car to start moving, accelerate or climb a gradient.

Electronic differential lock (EDL)

When the EDL detects wheelspin, it brakes the spinning wheel and directs the power to the other driven wheel. This function is active up to approximately 100 km/h (62 mph).

To prevent the disc brake of the braked wheel from overheating, the EDL cuts out automatically if subjected to excessive loads. The vehicle can still be driven. The EDL will switch on

again automatically when the brake has cooled down.

Electronic engine torque management (XDS)

When taking a curve, the driveshaft differential allows the outer wheel to turn at a higher speed than the inner wheel. In this way, the wheel that is turning faster (outer wheel) receives less drive torque than the inner wheel. This may mean that in certain situations the torque delivered to the inner wheel is too high, causing the wheels to spin. On the other hand, the outer wheel is receiving a lower drive torque than it could transmit. This can cause a loss of grip on the drive axle, in this case the front axle, which results in understeer or "lengthening" of the trajectory.

The XDS can detect and correct this effect via the sensors and signals of the ESC.

Via the ESC, the XDS will brake the inside wheel and counter the excess driving torque of that wheel. This means that the requested trajectory is much more precise.

XDS works in combination with the ESC and is always active, even when ASR is disconnected, or when the ESC is in Sport mode or disconnected.

WARNING

Driving at high speed on icy, slippery wet ground can result in loss of vehicle control

and serious injury to the driver and passengers.

- The ESC, ABS, ASR, EDS and the electronic torque control system cannot exceed the limits imposed by the laws of physics. Always bear this in mind, especially on wet or slippery roads. If you notice the systems cutting in, you should reduce your speed immediately to suit the road and traffic conditions. Do not be encouraged to take risks by the presence of more safety systems. If you do, an accident may occur.

- Please remember that the accident risk always increases if you drive fast, especially in corners or on a slippery road, or if you follow too close behind the vehicle in front of you. The ESC, ABS, brake assist, EDS and the electronic torque control system cannot prevent accidents: risk of accidents!

- Accelerate with caution on slippery surfaces (for example, icy or snow-covered). Despite the control systems, the driven wheels could spin, affecting the stability of the vehicle: risk of accident!

⚠ WARNING

The effectiveness of ESC can be considerably reduced if other components and systems affecting driving dynamics are not maintained or are not functioning correctly. This includes, among others, brakes, tyres and other systems already mentioned.

- Remember that changing and fitting other components to the vehicle can affect operation of the ABS, HBA and ESC.

- Changes to the vehicle suspension or using unapproved wheel/tyre combinations can affect operation of the ABS, HBA and ESC, as well as their effectiveness.

- Likewise, the effectiveness of ESC depends on the use of suitable tyres
»» page 328.

i Note

- The ABS and ASR will only operate correctly if the four wheels have identical tyres. Any differences in the rolling radius of the tyres can cause the system to reduce engine power when this is not desired.

- The regulating processes of the systems can make noises due to their operation.

- If the warning lamp  or  lights up, there could be a fault »» page 87.

- Any modifications made to the vehicle (for example, to the engine, brake system, running gear or to the combination of wheels and tyres) may affect the operation of the ABS, ASR and EDS.

Connecting and disconnecting the ASR

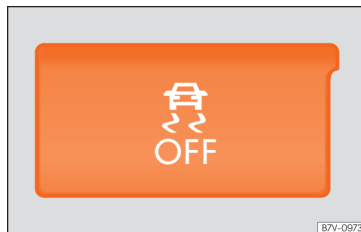




Fig. 268 Detailed view of the centre console: button used to switch ASR on and off (vehicles with ESC)

The electronic stability control ESC consists of ABS, EDL and ASR and only works when the engine is running.

The ASR can be switched off while the engine is running by pressing the  **OFF** button »» Fig. 268. The ASR (and similar) is only switched off when the required traction is not obtained:

- When driving through deep snow or on loose ground (gravel, etc.).
- When “freeing” a trapped vehicle.

Turn the ASR back on by pressing the  **OFF** button »» Fig. 268.

Parking

To park the vehicle

When parking your vehicle, all legal requirements should be observed.

Always note the following points when parking the vehicle:

- Park the vehicle on a suitable surface » » » ⚠
- Connect the electronic parking brake » » » page 285.
- For an automatic gearbox, move the selector lever to position **P**.
- Switch the engine off and remove the key from the ignition. Turn the steering wheel slightly to engage the steering lock.
- With a manual gearbox, engage first gear on flat ground and slopes, or even reverse gear on hills, and release the clutch pedal.
- When leaving the vehicle, take all keys with you.

Additionally, on steep slopes and inclines

Before switching off the engine, rotate the steering wheel so that if the vehicle should move, it will be held by the kerb.

- On slopes, turn the front wheels so that they are against the edge of the kerb.

- Uphill, turn the wheels towards the centre of the road.

⚠ WARNING

- **Avoid parking the vehicle where the hot exhaust system could ignite inflammable materials, such as dry grass, low bushes, spilt fuel or flammable materials.**
- **Do not leave passengers inside a closed vehicle, they may not be able to open doors or windows. Locked doors hinder the possibility of a rescue.**
- **Children should not be left alone in the vehicle. They could tamper with the hand-brake or the gears, which could cause the vehicle to move without control.**
- **Depending on weather conditions, it may become extremely hot or cold inside the vehicle. This can be fatal.**

i Note

In vehicles with automatic transmission, the key can only be removed from the ignition when the lever is in position P.

Help with parking and manoeuvring

Park Assist system

Introduction

The Park Assist system helps the driver to find a suitable place to park, to insert the vehicle into parallel and perpendicular parking places and to leave parallel parking places.

The Park Assist system is limited to the system abilities and requires that the driver is especially attentive » » » ⚠.

The parking sensor system is a component of the Park Assist system that helps to park the vehicle.

For vehicles with the optical parking system (OPS), the infotainment system screen displays the detected zones in front of and behind the vehicle, indicating - within the limits of the system - the position of obstacles in relation to the vehicle.

The park assist system cannot be switched on if the factory-fitted towing bracket is electrically connected to a trailer.

⚠ WARNING

Despite the assistance provided by the park assist system, do not run any risks

when parking. The system is not a replacement for driver awareness.

- Unintentional movements of the vehicle could cause serious injury.
- Adjust your speed and driving style to visibility, road, traffic and weather conditions.
- The surface of certain objects and items of clothing and external sound sources may have a negative affect on the park assist signals or on the system sensors or may not reflect its signals.
- The sensors have blind spots in which obstacles and people are not registered.
- Always observe the area around the vehicle, as the sensors do not always detect small children, animals or objects.

ⓘ CAUTION

- The park assist system aims exclusively at other parked vehicles, without taking curbs or other circumstances into account. Make sure you do not damage the tyres and wheel rims when parking. Where necessary, stop manoeuvring to avoid damaging the vehicle.
- The sensors may not always be able to detect objects such as trailer draw bars, thin rails, fences, posts and trees, etc. This could result in damage to your car.
- Although the parking distance warning system detects and warns of the presence of an obstacle, the obstacle could disap-

pear from the measurement angle of the sensors if it is too high or low and the system would no longer show it. Therefore, it will not warn you of these objects. Ignoring the warnings of the parking sensor system could cause considerable damage to the vehicle. This is also valid when using the park assist (e.g. to park behind a truck or motorcycle). Therefore, always keep a close watch on the area in front of and behind the vehicle while parking, and intervene promptly if necessary.

- To ensure that the system works properly, the bumper sensors must be kept clean, free of ice and snow and uncovered.
- The bumper sensors may become damaged or misaligned, for example, when parking.
- When cleaning the sensors with high-pressure or steam cleaning equipment, spray the sensors briefly at a distance of no less than 10 cm.

ⓘ Note

If there is a fault in the system, go to a specialised workshop. SEAT recommends taking your car in for technical service.

Parking using the park assist system

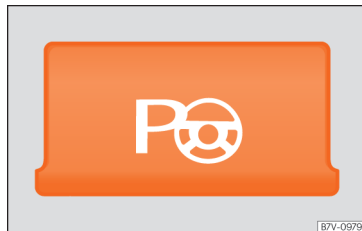


Fig. 269 Detailed view of the centre console: button to switch the park assist system on manually. »

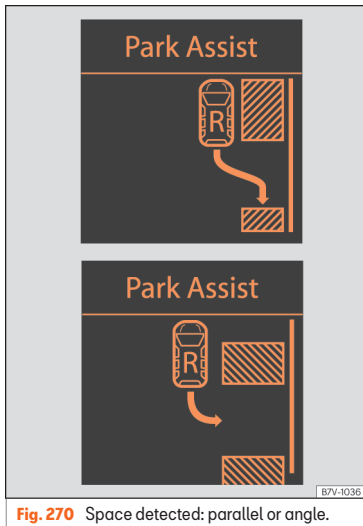





Fig. 270 Space detected: parallel or angle.


Parking preparations

- The Traction control system ASR must be turned on »» page 285.
- **In parallel parking:** press the 
- »» **Fig. 269** button as many times as necessary to select the desired parking mode. When the function is enabled, the lamp button will light up.

- **In head-in parking:** press the 
- »» **Fig. 269** button as many times as necessary to select the desired parking mode. When the function is enabled, the lamp button will light up.

- If necessary, press the  button once more to change parking mode.
- Apply the turn signal for the side on which a gap is to be detected for parking. The instrument panel displays the side corresponding to the road.

Parking


- **When parking parallel to the road:** drive next to the gap at a speed of no more than 40 km/h (25 mph) **and** at a distance of between 0.5 m and 2 m.
- **When parking perpendicular to the road:** drive next to the gap at a speed of no more than 20 km/h (12 mph) **and** at a distance of between 0.5 m and 2 m.
- The best parking results will be achieved if you position the vehicle as parallel as possible to the line of parked cars or the kerb.
- When a suitable parking place is displayed on the instrument panel, stop and select reverse gear.
- Follow the instructions given on the instrument panel display
- Then, release the steering wheel when the warning signal sounds »» : **The system**


will move the steering wheel! Observe the surrounding area.

- Observe the surrounding area and accelerate carefully at a maximum of 7 km/h (4 mph).
- The park assist system is **only** responsible for moving the steering wheel during the manoeuvre. **The driver applies the accelerator, the clutch, the gears and the brake.**
- Follow the instructions given by the park assist system until the manoeuvre is completed.
- The park assist system steers the vehicle forwards and backwards until it is in a straight position in the parking space.
- The manoeuvre is complete when the corresponding indication is given on the instrument panel display.

Finishing early or interrupting the parking manoeuvre

The park assist system stops the manoeuvre in advance in the event of one of the following:

- Press button .
- Driving faster than 7 km/h (4 mph).
- The driver moves the steering wheel.
- The parking manoeuvre has not been completed after 6 minutes since the park assist system was activated.

- A sliding door is opened. To restart the manoeuvre, close the sliding door and press the  button again.
- There is a system malfunction (system temporarily unavailable).
- The ASR system is switched off or the ASR or ESC is working.



WARNING

The steering wheel turns quickly by itself when parking using the park assist system. Placing your hand between the steering wheel spokes could lead to injuries.

Note





- The park assist system has its limitations. For example, it is not possible to park on tight bends using the park assist system.
- Even if the park assist system recognises that there is not enough space for parking the vehicle, the instrument panel display will still show this place. In this case, the parking manoeuvre should not be requested.
- Changing gears between forward and reverse gears before indicated (that is, before the signal from the parking sensor system) the parking results may not be ideal.
- For parallel parking (parallel to the road), a sound will tell the driver when they must change from forward gears to reverse; the

signal from the parking sensor system does not indicate changes of direction.

- The park assist can also be activated afterwards, if you pass close to a parallel parking space at a maximum of 40 km/h (25 mph) or close to a perpendicular parking space at about 20 km/h (12 mph) and then press the  button.
- The progress bar on the screen of the instrument panel shows a display of the relative distance to be covered.
- When the Park Assist system is turning the steering wheel of the stopped vehicle the  symbol is also displayed. Press on the brake pedal so that the steering can turn with the vehicle at a standstill and thus reduce the number of manoeuvres.
- A “suitable” parking space length is at least 1.1 m greater than the length of the vehicle.
- If the results of the park assist system are not as good after changing the wheels, the system must memorise the perimeter of the new wheels. This process is performed automatically while the vehicle is in motion. To help this process, turn slowly (at less than 20 km/h [12 mph]), e.g. in an empty car park.


Leaving a parking space using the Park Assist system

Exiting a parking space

- Switch on the engine.
- Press button . When the function is enabled, the button  **Fig. 269** will light up.
- Apply the turn signal for the side on which you want to leave the parking space.
- Select reverse gear.
- Follow the instructions given by the park assist system.
- When the next indication appears, release the steering wheel   in Parking using the park assist system on page 293: **The system will move the steering wheel! Observe the surrounding area.**
- Observe the surrounding area and accelerate carefully at a maximum of 7 km/h (4 mph).
- The park assist system is **only** responsible for moving the steering wheel during the manoeuvre. **The driver applies the accelerator, the clutch, the gears and the brake.**
- When it is possible to leave the parking space, the Park Assist system will stop. Take control of the steering and when traffic conditions permit, leave the parking space. »

Automatic interruption of the manoeuvre


The park assist system stops the manoeuvre in the event of one of the following:

- Driving faster than 7 km/h (4 mph).
- The driver moves the steering wheel.
- A sliding door is opened. To restart the manoeuvre, close the sliding door and press the  button again.
- There is a system malfunction (system temporarily unavailable).
- The ASR system is switched off or the ASR or ESC is working.

WARNING

The steering wheel turns quickly automatically when leaving a parking space using the park assist system. Placing your hand between the steering wheel spokes could lead to injuries.

Park Assist brake operation

The Park Assist system helps the driver by braking automatically. Automatic braking does not relieve the driver of responsibility for controlling the accelerator, brake and clutch .

Braking to avoid damage due to unsuitable speed

It is possible that the system operates the brakes to reduce excess speed. The parking manoeuvre can then continue. The brakes will intervene during each parking process.

Braking to minimise damage

When approaching an obstacle, the vehicle may brake automatically. In certain circumstances (e.g. storm, detection of ultrasounds, vehicle status, load, inclination), the Park Assist system may stop the vehicle completely before an object.

- Press the foot brake .

Following the intervention of the brakes, the Park Assist will stop.

WARNING

Despite the assistance provided by the park assist system, do not run any risks when parking. The system is not a replacement for driver awareness.

- Always be ready to brake.
- Automatic brake intervention will end after 1.5 seconds approximately. Following automatic intervention of the brakes, stop the vehicle yourself.

Parking aid

Introduction

The parking aid helps the driver when parking and manoeuvring. When the vehicle approaches an obstacle, forwards or backwards, an intermittent audible warning will be heard, higher or lower depending on the distance. The shorter the distance, the shorter the intervals between tones. If the vehicle is too close to the obstacle, the audible warning becomes constant.

If you continue to approach an obstacle when the sound is continuous, this means the system can no longer measure the distance.

The sensor system on the bumpers transmit and receive ultrasound. Using the ultrasound signal (transmission, reflection from the obstacle and reception), this system continuously calculates the distance between the bumper and the obstacle.

WARNING

The parking aid and the optical parking system are no substitute for driver awareness.

- The sensors have blind spots in which obstacles and people are not registered.
- Always observe the area around the vehicle, as the sensors do not always detect small children, animals or objects.

- The surface of certain objects and some clothing do not reflect the ultrasound signals from the parking distance system. The system cannot detect or incorrectly detects these objects and people wearing these types of clothes.
- External sound sources can affect the parking distance aid signals. In this case, under certain circumstances, people and objects will not be detected.

ⓘ CAUTION

- The sensors may not always be able to detect objects such as trailer draw bars, thin rails, fences, posts, trees and open boots, etc. This could result in damage to your car.
- Although the parking distance warning system detects and warns of the presence of an obstacle, the obstacle could disappear from the measurement angle of the sensors if it is too high or low and the system would no longer show it. Therefore, it will not warn you of these objects. Ignoring the warnings of the parking sensor system could cause considerable damage to the vehicle.
- The bumper sensors may become damaged or misaligned, for example, when parking.
- To ensure that the system works properly, the bumper sensors must be kept clean, free of ice and snow and uncovered.

- When cleaning the sensors with high-pressure or steam cleaning equipment, spray the sensors briefly at a distance of no less than 10 cm (4 inches).

ⓘ Note

Acoustic sources may lead to erroneous warnings on the parking sensor system, e.g. rough tarmac, cobbles or the noise of other vehicles.

Connecting and disconnecting



Fig. 271 Detailed view of the centre console: button to connect or disconnect the park assist.



Fig. 272 Parking sensor system sensors on the front bumper

- Press the **P** button when the ignition is switched on »» **Fig. 271**.
- *Automatic connection:* engage reverse gear.
- *Automatic disconnection:* drive faster than 15 km/h (9 mph).

The button lights up when the function is switched on.

Special characteristics

- The parking aid system sometimes detects water on the sensors as an obstacle.
- If the distance does not change, the warning signal will sound less loudly after a few seconds. If the continuous signal sounds, the volume will remain constant.
- When the vehicle moves away from the obstacle, the beeping sound automatically switches off. On approaching the obstacle »

again, the beeping sound will automatically switch back on.

- If the electronic parking brake is engaged or the selector lever is set to **P**, no audible warning will be emitted.
- Your technical service centre can adjust the volume of the warning signals.

i Note

If the parking aid system is faulty, a continuous audible warning will sound when it is switched on for the first time, and the button will flash. Press the button to disconnect the park assist and have the system checked as soon as possible by a specialised workshop.

Optical parking system (OPS)

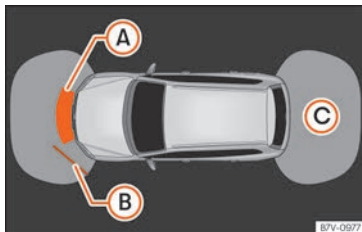


Fig. 273 On-screen OPS display: **A** has detected an obstacle in the collision zone; **B** has detected an obstacle in the segment; **C** zone recorded behind the vehicle.

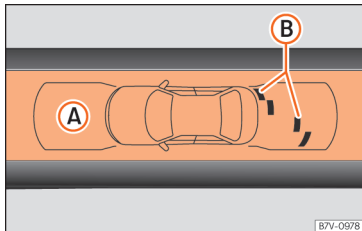


Fig. 274 On-screen OPS display: **A** area recorded in front of the vehicle; **B** an obstacle has been detected in the segment.

The optical parking system is an accessory to the parking aid system »» page 295 and the park assist system »» page 290.

The zone recorded by the sensors in front of and behind the vehicle is displayed on the factory-fitted infotainment system display. Any obstacles are displayed in relation to the vehicle »» .

The OPS activates automatically when the parking aid »» page 295 or the park assist system is connected »» page 290.

Manual disconnection of the optical indication

- Press a button on the factory-fitted infotainment system, for example the **RADIO** button.
- **OR**: briefly press the function button or **RVC** on the screen.

Automatic disconnection of the optical indication

- Drive forwards at around 10-15 km/h (6-9 mph).
- On vehicles with reverse assist, engage reverse gear »» page 297. The display changes to the image of the camera.

Zones explored

The approximate measurement range of the sensors is:

- Front area: 1.20 m
- Front side area: 0.60 m
- Rear area: 1.60 m

- Rear side area: 0.60 m

Screen display

The image displayed represents the super-vised zones in several segments. As the vehicle approaches an obstacle, it approaches the displayed vehicle segment »» Fig. 273 (B) and »» Fig. 274 (B). Ultimately, when the second-to-last segment is shown, the collision area has been reached. **Stop the vehicle!**

Segment colours (colour screen)

Yellow The distance to the obstacle ahead is approximately **31-120 cm** and **31-160 cm** behind. The audio signal is intermittent.


Red The distance to the obstacle ahead or behind is approximately **0-30 cm**. The audio signal is continuous.¹⁾

With trailer

A specific image is displayed on the screen of vehicles with a factory-fitted towing bracket and an electrically connected trailer. In this case, the distances behind the vehicle are not indicated.

¹⁾ The permanent sound starts at a somewhat greater distance on vehicles with a factory-fitted towing bracket.

Switching the parking sensor system sound on and off

If the  button on the infotainment system display is pressed briefly, it may mute the sound of OPS warnings. To switch the warnings back on, press the button again briefly.

When the OPS is switched off and back on again, muting is cancelled. Error messages cannot be switched off.

WARNING

Do not be distracted from the traffic when looking at the screen.

Reverse Assist (Rear View Camera)

Introduction

The camera fitted to the rear lid helps drivers during parking or reversing manoeuvres »» page 262. The camera image and certain orientation points generated by the system are indicated on the factory-fitted infotainment system screen.

Two types of location point (modes) can be selected:

- **Mode 1:** reverse parking perpendicular to the road (e.g. in a car park).
- **Mode 2:** reverse parking parallel to the curb.

The mode can be changed by pressing the button on the infotainment system screen. Only the mode to which the points can be changed will be displayed.

WARNING

Use of the camera to calculate the distance from obstacles (people, vehicles, etc.) is inaccurate and may cause accidents and severe injuries.

- The camera lens expands and distorts the field of vision and displays the objects on the screen in a different, vague manner.
- Some objects may not be displayed or may not be very clear (e.g. very thin posts or fences), due to the resolution of the monitor or if the light is dim.
- The camera has blind spots in which obstacles and people are not detected.
- Keep the camera lens clean and clear of snow and ice. Do not cover it.

»

⚠ WARNING

The intelligent technology in the rear assist system cannot change the limits imposed by the laws of physics and by the system itself. Careless or uncontrolled use of the rear assist system may result in severe injuries and accidents. The system is not a replacement for driver awareness.

- Adjust your speed and driving style to visibility, road, traffic and weather conditions.
- Always keep a close eye on the area around the vehicle and always look towards where you are parking. The display shows the path of the rear end of the vehicle using the current steering angle. The front of the vehicle turns more in comparison with the rear.
- Do not be distracted from the traffic when looking at the screen.
- Always observe the area around the vehicle, as the cameras do not always detect children, animals or objects.
- The system might not show all areas clearly.
- Only use the rear assist system when the boot hatch is completely closed.

⚠ CAUTION

• The camera only displays 2D images on the screen. Due to the lack of depth, it might be difficult or impossible to recog-

nise protruding objects or cracks in the road.

- The cameras may not always be able to detect objects such as thin rails, fences, posts and trees, etc. This could result in damage to your car.

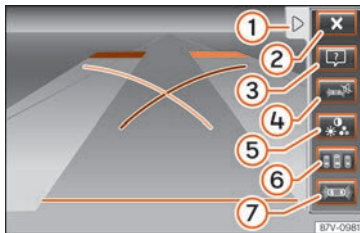
Usage instructions

Fig. 275 Reverse assist indication: mode 2 connected.

Function buttons on the screen:

- 1 ◀ display the menu; ▶ hide the menu.
- 2 X Turning off the reversing camera images.
- 3 Display help. The help list explains the surfaces and lines on the camera image. Press ↵ to exit help.
- 4 Mute the sound.
- 5 Adjust the display: bright, contrast, colour.

- 6 Switching on the orientation points for rear parking perpendicular to the road (mode 1).
- 7 Displaying the optical parking system.

Reverse assist works when the ignition is on or with the engine running. After switching off the ignition, the reverse assist image remains briefly on the screen.

Connecting the reverse assist

- Select reverse gear. Mode 1 will be displayed.

Manual disconnection

- Press the **P** button (vehicles with an optical parking system).
- **OR**: press a button on the factory-fitted infotainment system, for example the **RADIO** button.
- **OR**: press the X button on the screen.

Automatic off

- Release the reverse gear. The image turns off after about 10 seconds, or, in vehicles with parking systems (OPS), the OPS indication is immediately displayed.
- **OR**: Drive forward at more than 15 km / h (9 mph), approximately.

Do not use the reverse assist system in the following cases

- – If there is a fault in the dynamic chassis control (DCC).
- If the image displayed is not very clear or reliable (low visibility or dirty lens).
- If the space behind the vehicle cannot be clearly or completely recognised.
- If the vehicle has been overloaded at the rear.
- If the driver is not familiar with the system.
- If the rear lid is open.
- If the position and installation angle of the camera have been changed, e.g. in a rear-end collision. Have a specialised workshop check the system.

Optical illusions of the camera (examples)

The rear assist camera produces two-dimensional images. Any cracks in or objects protruding from the ground or from other vehicles are more difficult to spot or cannot be seen due to a lack of depth in the image displayed.

Objects or other vehicles may seem to be closer or further away than what they really are:

- On changing from a flat surface to a slope or gradient.

- On changing from a slope or gradient to a flat surface.
- If the vehicle has been overloaded at the rear.
- On approaching protruding objects. These objects may be outside the angle of vision of the camera when reversing.

i Note

- SEAT recommends that you practise parking with the rear assist system in a quiet location or in a car park to become familiar with the system, including the orientation lines and their function.
- The orientation lines will not be displayed on the screen if the rear lid is open or the factory-fitted towing bracket is electrically connected to a trailer.

Parallel parking (mode 1)

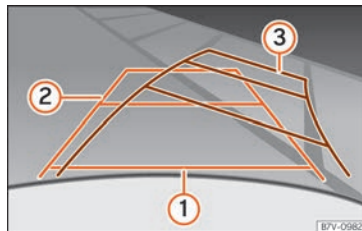


Fig. 276 Screen: orientation lines for the parking space behind the vehicle.

Summary of the orientation points

Meaning of orientation lines displayed on the screen »» **Fig. 276**. All of the lengths of the orientation lines use a vehicle located on a horizontal surface as reference.

- ① Red: safety distance, i.e. road area located up to 40 cm behind the vehicle.
- ② Green: prolongation of the rear of the vehicle (somewhat enlarged). The area displayed green ends around 2 metres behind the vehicle, on the road.
- ③ Yellow: prolongation of the rear of the vehicle as the steering wheel turns. The area displayed yellow ends around 3 metres behind the vehicle, on the road. »

Parking

- Stop the vehicle in front of a space and select reverse gear.
- Reverse slowly and turn the steering wheel so that the yellow orientation lines guide you towards the space »» Fig. 276 ③.
- Align the vehicle straight in the parking place using the help of the green orientation lines.

Parallel parking (mode 2)

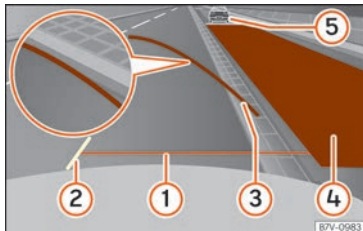


Fig. 277 Screen: orientation lines and surfaces for the space behind the vehicle.

After applying the turn signal, the lines and surfaces not required are deleted.

Summary of the orientation points

Meaning of orientation lines and surfaces displayed on the screen »» Fig. 277. All of the

lengths of the orientation lines use a vehicle located on a horizontal surface as reference.

- ① Safety distance: road area located up to 40 cm behind the vehicle.
- ② Vehicle side limit.
- ③ Turning point when parking. When the yellow line touches the curb or another limit of the parking space, the point for changing direction (magnifying glass) will have been reached.
- ④ Free space required to parallel park the vehicle. The surface displayed must completely fit in the space.
- ⑤ Possible vehicle parked next to the curb.

Parking

- Stop the vehicle 1 m away parallel to the parking space and select reverse gear.
- Switch on mode 2 on the navigation system screen for parallel parking.
- Slowly reverse and turn the steering wheel so that the surface displayed yellow on the screen stops in front of any obstacles ⑤ (e.g. another vehicle).
- Turn the steering wheel fully towards the space and reverse slowly.
- When the yellow line ③ touches the side limit of the space, e.g. the border or curb (magnifying glass), turn the steering wheel fully in the opposite direction.

- Continue reversing until the vehicle is inside the space, parallel to the road. Correct the position if necessary.

Towing bracket device

Trailer mode

Introduction

Take into account country-specific regulations about driving with a trailer and the use of a towing bracket.

The vehicle has been developed primarily for carrying people, although it can also be used to tow a trailer if fitted with the corresponding technical equipment. This additional load has an effect on the useful life, fuel consumption and vehicle performance and in some cases can reduce the service intervals.

Driving with a trailer requires more force from the vehicle, and thus more concentration from the driver.

In winter, winter tyres should be fitted on both the vehicle **and** the trailer.

Maximum vertical load technically permitted on the coupling device

The *maximum* technically permitted vertical load of the tow bar on the hitch of the towing device is **100 kg [220 pounds]**.

Vehicles with the Start-Stop system

If the vehicle has a factory-fitted towing bracket or one that is retrofitted by SEAT, the

Start-Stop system operates as normal. No special characteristics need to be taken into account.

If the system does not recognise the trailer or the trailer bracket has not been retrofitted by SEAT, the Start-Stop system must be disconnected by pressing the corresponding button in the lower part of the centre console before driving with the trailer, and it should remain off for the rest of the journey »» » ⚠.

Trailer weight/drawbar load

Never exceed the authorised trailer weight. If you do not load the trailer up to the maximum permitted trailer weight, you can then climb correspondingly steeper slopes.

The maximum trailer weights listed are only applicable for **altitudes** up to 1000 m above sea level. Since higher altitude decreases engine performance and the ability to climb slopes, the tow load decreases proportionally. The weight of the vehicle and trailer combination must be reduced by 10% for every 1000 m of altitude. When possible, operate the trailer with the maximum **authorised drawbar load** on the ball joint of the towing bracket, but **do not exceed** the specified limit.

⚠ WARNING

Never use the trailer to transport people, since it would put their life in danger and is also prohibited.

⚠ WARNING

Undue use of the towing bracket may cause injury and accidents.

- Only use the towing bracket if it is in a perfect state of repair and is properly secured.
- Never modify or repair the towing bracket in any way.
- In order to reduce the danger of injury in the event of rear-end collisions and to avoid injury to pedestrians and cyclists when parking the vehicle, cover or remove the tow hook when you are not using a trailer.
- According to EU regulation 2021_535 it is not permitted to install a towing device that completely or partially covers the rear number plate.
- Never fit a towing bracket "with weight distribution" or "load compensation". The vehicle has not been designed for this type of towing bracket. The towing bracket could fail and the trailer could be released from the vehicle. »

⚠ WARNING

Driving with a trailer and transporting heavy or large objects can affect driving properties and even cause an accident.

- Always secure the load properly using belts or straps that are suitable and in good condition.
- Adapt your speed and driving style at all times to suit visibility, weather, road and traffic conditions.
- Trailers with a high centre of gravity are more likely to overturn than those with a low one.
- Avoid sudden braking and manoeuvres.
- Take great care when overtaking.
- Reduce speed immediately if you notice that the trailer is swaying, however slightly.
- Never drive at more than 80 km/h (50 mph) when towing a trailer (or at more than 100 km/h (60 mph) in exceptional circumstances). This also applies in countries where driving at higher speeds is permitted. Take into account the speed limit for vehicles with trailers in the corresponding country, as it could be less than the speed limit for vehicles without a trailer.
- Never attempt to "straighten" the towing vehicle and trailer while accelerating.

⚠ WARNING

If the towing bracket has been retrofitted by a non-SEAT workshop, the Start-Stop

system must be disconnected manually whenever driving with a trailer. Otherwise the brake system could be damaged and could consequently cause a serious accident or injury.

- Always disconnect the Start-Stop system manually when using a towing bracket that has not been fitted by a SEAT workshop.

i Note

- Before hitching or unhitching a trailer, always deactivate the anti-theft alarm »» page 95. Otherwise, the tilt sensor could cause the alarm to go off.
- Do not drive with a trailer for the engine's first 1000 km »» page 255.
- If a removable and retractable tow hook is fitted, it should not be mounted when not in use. In the event of a rear-end collision, the damage to the vehicle could be greater if the tow hook is fitted.
- Some retrofitted towing brackets cover the rear towing eye. In these cases, the towing eye should not be used for tow-starting or for towing other vehicles. For this reason, if the vehicle has been retrofitted with a towing bracket, always keep the tow hook in the vehicle when you remove it.

Technical requirements

Vehicles that are **factory**-fitted with a towing bracket meet all the technical and legal requirements for driving with a trailer.

If the **vehicle is retrofitted** with a towing bracket, only a bracket that is authorised for the maximum authorised load of the trailer that is to be towed may be fitted. The towing bracket must be suitable for the vehicle and the trailer and must be properly secured to the vehicle's chassis. Only use a towing bracket that has been authorised by SEAT for this vehicle. Always check and take into account the towing bracket manufacturer's instructions. Never fit a towing bracket "with weight distribution" or "load compensation".

Towing bracket fitted on the bumper

Never fit a towing bracket to the bumper or to the area where the bumper is mounted. The towing bracket should not impair the bumper's function. Do not make modifications or repairs to the exhaust system or the brake system. Make regular checks to ensure that the towing bracket is secure.

Engine cooling system

Driving with a trailer increases the load on the engine and cooling system. The cooling system should have sufficient coolant and be prepared for the additional effort involved in driving with a trailer.

Trailer brakes

If the trailer has its own brake system, please take the relevant legal requirements into account. Never connect the trailer's brake system to the vehicle's brake system.

Tow cable

Always use a cable between the vehicle and the trailer »» page 303.

Trailer tail lights

The trailer's rear lights should comply with the statutory safety regulations »» page 303.

Never connect the trailer's rear lights directly to the vehicle's electric system. If you are not sure that the trailer's electrical connection is correct, have it checked by a specialised workshop. SEAT recommends visiting a SEAT dealership for this.

Exterior mirrors

If you cannot see the area behind the trailer with the exterior mirrors of the towing vehicle, additional mirrors will have to be installed in accordance with the regulations of the country in question. The exterior mirrors should be adjusted before you start driving and must provide a sufficient field of vision at the rear.

Trailer maximum electricity consumption

Never exceed the values indicated!

Brake lights (total)	84 Watts
Turn signal (on each side)	54 watts
Side lights and rear lights	50 Watts
Reverse lights (in total)	42 Watts
Rear fog light	42 Watts

⚠ WARNING

If the towing bracket is wrongly fitted or is not the right one, the trailer could become detached from the vehicle and cause serious injury.

ⓘ CAUTION

- **If the rear lights of the trailer are not correctly connected, the vehicle's electronic system may be damaged.**
- **If the trailer absorbs excessive electric current, the vehicle's electronic system may be damaged.**
- **Never connect the trailer's electric system directly to the electrical connections of the tail lights or any other power sources. Only use the connections intended for providing electric current to the trailer.**

Hitching and connecting a trailer

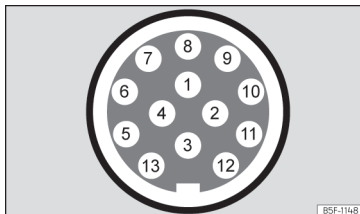


Fig. 278 Schematic representation: assignment of the pins of the trailer's electrical socket.

Pin	Meaning
1	Left turn signal
2	Rear fog light
3	Earth, pins 1 to 8
4	Right turn signal
5	Rear light, right
6	Brake lights
7	Rear light, left
8	Reverse lights
9	Permanent live
10	Live charge cable
11	Unassigned

»

Pin	Meaning
12	Unassigned
13	Earth, pins 9 to 13

Power socket for trailer

The vehicle is fitted with a 13-pole power socket for the connection between the trailer and the vehicle. With the engine running, electrical devices on the trailer receive power from the electrical connection (pin 9 and pin 10 of the trailer power socket).

If the system detects that a trailer has been connected, the consumers on the trailer will receive electricity through this connection (pins 9 and 10). Pin 9 has a permanent live. This powers, for example, the trailer's interior lighting. Electrical devices such as a fridge in a caravan **only** receive electrical power if the engine is running (through pin 10).

To avoid overloading the electrical system, you cannot connect the ground wires of pin 3 or pin 13 to each other.

If the trailer has a **7-contact connector**, you will need to use an adapter cable. In this case the function corresponding to pin 10 will not be available.

Tow cable

The tow rope must always be securely fixed to the towing vehicle and loose enough so

that the vehicle can handle turns smoothly. However, make sure that the cable does not rub on the ground while driving.

Trailer tail lights

Always check the trailer's rear lights to ensure they are working correctly and that they comply with the relevant safety regulations. Make sure that the maximum permissible power that can be absorbed by the trailer is not exceeded » **page 303**.

Include in the anti-theft alarm

The trailer is included in the anti-theft system if the following conditions are met:

- If the vehicle is factory-equipped with an anti-theft alarm and towing bracket.
- If the trailer is electrically connected to the towing vehicle through the trailer power socket.
- If the electrical systems of the vehicle and trailer are in perfect condition and have no faults or damage.
- If the vehicle is locked with the key and the anti-theft alarm is activated.

When the vehicle is locked, the alarm is triggered if the electrical connection with the trailer is cut off.

Before hitching or unhitching a trailer, always turn off the anti-theft alarm. Otherwise, the tilt sensor could cause the alarm to go off.

Trailers with LED tail lights

For technical reasons, trailers fitted with LED rear lights cannot be connected to the anti-theft alarm system.

When the vehicle is locked, the alarm does not go off when the electrical connection with the trailer is cut if it has rear lights with light-emitting diodes.

WARNING

If the cables are improperly or incorrectly connected, it may lead to an excessive amount of current supplied to the trailer, which can cause abnormalities in the entire vehicle electronic system, as well as accidents and serious injuries.

- Ensure that any repairs that need to be carried out on the electrical system are carried out by a specialised workshop.
- Never connect the trailer's electric system directly to the electrical connections of the tail lights or any other power sources.

WARNING

Contact between the pins of the trailer power socket can cause short circuits, overloading of the electrical system or

failure of the lighting system, and consequently can cause accidents and serious injuries.

- Never connect the pins of the trailer power socket to each other.
- Make sure any work on bent pins is carried out by a specialised workshop.

ⓘ CAUTION

Do not leave the trailer connected to the vehicle when parked; place it on its support wheel or its supports. If the vehicle rises or falls due, for example, to a variation of the load or a burst tyre, increased pressure will be placed on the towing bracket and the trailer, and both the vehicle and the trailer can be damaged.

ⓘ Note

- In case of anomalies in the electrical systems of the vehicle or trailer, as well as in the anti-theft alarm system, have them inspected by a specialised workshop.
- If the trailer accessories consume energy through the power socket to the trailer and the engine is turned off, the battery will discharge.
- If the vehicle battery is running low, the electrical connection with the trailer will be automatically cut.

Trailer loading

Technically permissible maximum trailer weight and vertical load on the coupling device

The technically permissible maximum trailer weight is the weight that the vehicle can tow »» ⚠. The vertical load on the coupling is exerted vertically from above on the hook of the towing bracket.

The information on the maximum trailer weight and vertical load on the coupling device contained in the type plate of the towing bracket are experimental values only. The correct figures for your specific model, which may be lower than these figures, are given in the vehicle documentation. The information in the vehicle documentation takes precedence at all times.

To promote safety while driving, SEAT recommends making the most of the maximum **vertical load** technically permissible on the coupling device »» page 301. An insufficient vertical load has a negative influence on the behaviour of both the vehicle and trailer.

The vertical load increases the weight on the rear axle, reducing the vehicle's carrying capacity.

Gross combination weight of the towing vehicle and trailer

The gross combination weight is the actual weight of the loaded vehicle plus the actual weight of the loaded trailer.

In some countries trailers are classified into distinct categories. SEAT recommends obtaining information from a specialised workshop regarding which type of trailer is most suitable for your vehicle.

Trailer loading

The weight of the towing vehicle and trailer must be balanced. In order to do this, the load must be as close as possible to the maximum vertical load technically permissible on the coupling point, and it must be evenly distributed between the back and front of the trailer:

- Distribute loads in the trailer so that heavy objects are as near to the axle as possible or above it.
- Secure the trailer load properly.

Tyre pressure

Set the tyre pressure of the trailer tyres in accordance with the trailer manufacturer's recommendations.

When towing a trailer, inflate the tyres of the towing vehicle with the maximum allowable pressure »» page 331.



⚠ WARNING

If the maximum permissible axle weight, the maximum load technically permissible on the coupling point, the maximum authorised vehicle weight or the gross combination weight of the towing vehicle and trailer are exceeded, accidents and serious injuries may occur.

- Never exceed the values indicated!
- The actual weight on the front and rear axles must never exceed the maximum permissible axle weight. The weight on the front and rear axles must never exceed the maximum permissible weight.

⚠ WARNING

A shift in weight could jeopardize the stability and security of the towing vehicle and trailer, which could lead to accidents and serious injuries.

- Always load the trailer correctly.
- Always secure the load properly using belts or straps that are suitable and in good condition.

Driving with a trailer**Adjusting the headlights**

The front part of the vehicle may be raised when the trailer is connected and the light may dazzle the rest of the traffic.

Adapt the height of the headlights using the headlight range adjuster »» page 123¹⁾.

Specific features of driving with a trailer



- If your trailer has an **overrun brake**, brake *gently at first* and then rapidly. This will prevent the jerking that can be caused by the locking of trailer wheels.
- Due to the gross combination weight of the towing vehicle and trailer, the braking distance increases.
- When going down a slope, go into a lower gear (if using a manual gearbox or the tip-tronic automatic gearbox mode) to take advantage of the braking power provided by the engine. Otherwise, the braking system could overheat and even fail.
- The trailer weight, as well as the gross combination weight of the towing vehicle and trailer, change the centre of gravity and the properties of the vehicle.

- If the towing vehicle is empty and the trailer is loaded, then the load distribution is incorrect. Under these conditions, drive slowly and with extra caution.

Hill starts with a trailer

Depending on the slope of the hill and the combination weight of the towing vehicle and trailer, the vehicle might start rolling backwards slightly when you first start up.

For hill-starting with a trailer, do the following:

- Press and hold the brake pedal.
- Press the  button once to disconnect the electronic parking brake »» page 285.
- If the vehicle is equipped with a manual gearbox, push the clutch pedal all the way down.
- Put the vehicle into first gear or turn the selector lever to position **D** »» page 247.
- Pull out the  button and hold it in that position to immobilise the towing vehicle and trailer with the electronic parking brake.
- Release the brake pedal.
- Start driving slowly. To do this, in the case of a manual gearbox, slowly release the clutch pedal.

¹⁾ This does not apply for vehicles with Full LED xenon headlights.

- Do not release the (P) button until the engine has sufficient power to start driving.

WARNING

If a trailer is pulled incorrectly, this may lead to loss of control of the vehicle and serious injury.



- Driving with a trailer and transporting heavy or large objects will change the vehicle handling and braking distances.
- Always drive cautiously and carefully. Brake earlier than usual.
- Adapt your speed and driving style at all times to suit visibility, weather, road and traffic conditions. Slow down, especially when driving down hills or slopes.
- Accelerate with particular care and caution. Avoid sudden braking and manoeuvres.
- Take great care when overtaking. Reduce speed immediately if you notice that the trailer is swaying, however slightly.
- Never attempt to “straighten” the towing vehicle and trailer while accelerating.
- Take into account the speed limit for vehicles with a trailer, as it could be lower than for vehicles without a trailer.

Stabilisation of the towing vehicle and trailer combination

The stabilisation of the vehicle and trailer combination is an additional function of the electronic stability control (ESC).

If the vehicle and trailer stabilisation system detects that the trailer is weaving, it takes action on the steering control to reduce the weaving of the trailer.

Vehicle and trailer combination stabilisation requirements

- The vehicle is factory-equipped with a towing bracket or has been retro-fitted with a compatible towing bracket.
- The ESC and ASR are active. The control lamp  or  is not lit up on the instrument cluster.
- The trailer is connected to the towing vehicle through the trailer power socket.
- The vehicle is travelling at over 60 km/h (approx. 37 mph).
- The maximum vertical load technically permissible is not being exceeded on the coupling device.
- The trailer has a rigid draw bar.
- If the trailer has brakes, it must be equipped with a mechanical overrun brake.

WARNING

The enhanced safety provided by the electric stability control of the vehicle and trailer should not lead you to take any risks that could compromise your safety.

- Adapt your speed and driving style at all times to suit visibility, weather, road and traffic conditions.
- Accelerate with caution when the road is slippery.
- When adjusting any settings, stop accelerating.

WARNING

The electric stability control for the vehicle and trailer may not correctly detect all driving conditions.

- When the ESC is switched off, the stabilisation of the towing vehicle and trailer is also switched off.
- The stability system does not always detect light trailers, so it may not stabilise these correctly.
- When driving on surfaces with poor grip, the trailer can even *interfere* with the stability system.
- Trailers with a high centre of gravity can tip over without having previously weaved.
- If a trailer is not attached, but a connector is plugged into the power socket (e.g. installation of a bicycle rack with lights),

»

repeated automatic braking may occur in extreme driving conditions.

Electrically unlocking trailer hook

Description

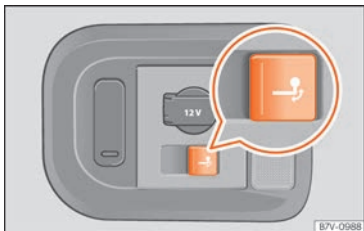


Fig. 279 On the right side of the luggage compartment: button for unlocking the tow hook.

The towing bracket's hook is located in the bumper. Tow hooks for electrical unlocking cannot be removed.

There should be no person, animal or object in the path of the tow hook » » » ⚠.

Unlocking the tow hook and removing it

- Stop the vehicle and connect the electronic parking brake » » » page 285.

- Switch off the engine.
- Open the rear lid.
- Pull the » » » Fig. 279 button briefly. The tow hook unlocks electrically and automatically turns outwards. The button's control lamp flashes.
- Finish remove the tow hook by hand until you feel and hear that it has engaged and the control lamp on the button stays on.
- Close the rear lid.
- Before hitching the trailer, remove the dust guard from the ball.
- The indicator only lights when the boot hatch is open and when a trailer is not hitched.

Retracting the tow hook

- Stop the vehicle and apply the electronic parking brake.
- Switch off the engine.
- Unhook the trailer and interrupt the electrical connection between it and the vehicle. If you are using an adapter, remove it from the trailer's power socket.
- Open the rear lid.
- Pull the » » » Fig. 279 button briefly. The tow hook unlocks electrically.
- Turn the tow hook under the bumper with your hand until you feel and hear that it en-

gages and the control lamp on the button remains on continuously.

- Close the rear lid.

The control lamp →

- If the warning light on the button » » » Fig. 279 → flashes, this means that the tow hook has not been attached properly or is damaged » » » ⚠.
- If the warning lamp » » » Fig. 279 → remains on with the rear lid open, the tow hook is correctly in place both when extracted and when covered.

The control light of the lamp switches off approximately 1 minute after closing the rear lid.

⚠ WARNING

Undue use of the towing bracket may cause injury and accidents.

- Only use the tow hook if it is properly engaged.
- Always ensure that no person, animal or object is to be found in the path of the tow hook.
- Never use a tool or instrument while the tow hook is moving.
- Never press the » » » Fig. 279 button when there is a trailer hooked to the vehicle or when a carrier system or other accessories are mounted on the tow hook.

- If the tow hook is not attached properly, do not use it. Instead, go to a specialised workshop and have the towing bracket checked.
- If you detect any fault in the electrical system or in the towing bracket, contact a specialised workshop and ask them to check it.
- If the ball has a diameter of less than 49 mm at any one point, do not use the towing bracket under any circumstances.

ⓘ CAUTION

If you clean the vehicle with high-pressure or steam devices, do not point the jet directly towards the retractable tow hook or the trailer power socket, as this may damage the joints or remove the grease necessary for lubrication.

ⓘ Note

At extremely low temperatures, the tow hook may be impossible to operate. In this case, place the vehicle in a warmer location (for example, a garage).

Fitting a bicycle carrier on the retractable towbar

The maximum allowed weight of the carrier system, including the load, is **75 kg**. The carri-

er system should not protrude more than 700 mm backwards from the spherical head. Only carrier systems on which up to 3 bikes can be mounted are allowed. Heavier bicycles must be mounted as close to the vehicle as possible (tow hook).

⚠ WARNING

The incorrect use of the tow hitch with a bicycle rack mounted on the tow hook can cause accidents and injury.

- Never exceed the maximum weight or the limits indicated above.
- The bicycle rack may not be mounted to the neck of the hook below the ball because, due to the shape of the neck and depending on the rack model, the rack could be incorrectly mounted on the vehicle.
- Always read and take the manufacturer assembly instructions into account.

ⓘ CAUTION

If the maximum weight and limits indicated above are exceeded, the vehicle may suffer considerable damage.

- Never exceed the values indicated!

ⓘ Note

SEAT recommends removing, as far as possible, all removable parts of the bicycles before setting off. These parts include, for

example, baskets and saddlebags, child seats or batteries. This improves aerodynamics and the centre of gravity of the rack system.

Retrofitting a towing bracket

Description

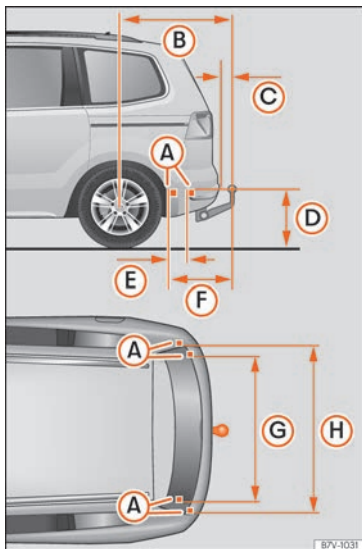


Fig. 280 Limits and attachment points for retrofitting a towing bracket.

SEAT recommends that towing brackets be retrofitted at a specialised workshop. For ex-

ample, it may very well be necessary to adjust the cooling system or mount thermal protection plates. SEAT recommends visiting a SEAT dealership for this.

If a towing bracket is retrofitted, the distance specifications should always be kept in mind.

The distance between the centre of the ball head and the road »» Fig. 280 (D) must never be less than indicated. This also applies when the vehicle is fully loaded, including the technically permissible maximum vertical load on the coupling device.

Separation distances »» Fig. 280:

- (A) Attachment points (lower part of the vehicle)
- (B) 1,040 mm (41 inches)
- (C) 74 mm (3 inches)
- (D) 364 mm (14 inches)
- (E) 247 mm (10 inches)
- (F) 596 mm (23 inches)
- (G) 1,097 mm (43 inches)
- (H) 1,102 mm (43 inches)

⚠ WARNING

If the cables are improperly or incorrectly connected, this may lead to malfunctions in the entire vehicle electronic system, as well as to accidents and serious injuries.

- Never connect the trailer's electric system to the electrical connections of the tail

lights or any other unsuitable power sources. Only use suitable connectors to connect the trailer.

- The towing bracket should be retrofitted only at a specialised workshop.

⚠ WARNING

If the towing bracket is badly fitted or unsuitable, the trailer may separate from the vehicle while driving. This could cause serious accidents and fatal injuries.

i Note

- According to regulation EU2021_535 it is not permitted to install a towing device that cannot be removed or retracted.
- Only use towing brackets that have been approved by SEAT for the model in question.
- In some versions, the fitting of a conventional towing hook solution is not recommended. Please consult your Technical Service.

Practical tips

Checking and refilling levels

Refuelling

Refuelling

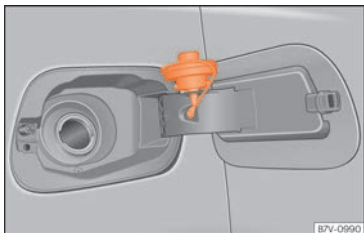


Fig. 281 Fuel tank flap with tank cap attached.

The fuel tank flap is on the rear right of the vehicle.

The flap that covers the tank cap is unlocked and locked automatically using the central locking.

- Open the fuel tank flap by pressing on the retainer zone.
- Unscrew the cap by turning it to the left.

- Place it in the space on the hinge of the open flap »» Fig. 281.
- Start refuelling. The tank is full as soon as the pump's automatic nozzle cuts off the fuel supply. Do not try to put in more fuel after the nozzle cuts out, as this will fill the expansion chamber in the fuel tank.
- Unscrew the cap by turning it to the right as far as it will go.
- Close the lid.

The correct fuel grade for your vehicle is given on a sticker on the inside of the fuel tank flap. Further notes on fuel can be found at »» page 312.

The capacity of your vehicle's fuel tank is given in »» page 357.

⚠ WARNING

Fuel is highly flammable and can cause serious burns and other injuries.

- When refuelling, turn off the engine, the auxiliary heater »» page 168 and turn off the ignition for safety reasons.
- Do not smoke when filling the fuel tank or a canister. Naked flames are forbidden in the vicinity due to the risk of explosion.
- Observe legislation governing the use, storage and carrying of a spare fuel canister in the vehicle.
- For safety reasons we do not recommend carrying a spare fuel canister in the vehi-

cle. In an accident the canister could be damaged and could leak.

• If, in exceptional circumstances, you have to carry a spare fuel canister, please observe the following points:

- Never fill fuel into the spare fuel canister if it is inside or on top of the vehicle. This could cause an explosion. Always place the canister on the ground to fill it.
- Insert the filling nozzle as far as possible into the spare fuel canister.
- If the spare fuel canister is made of metal, the filling nozzle must be in contact with the canister during filling. This helps prevent an electrostatic charge building up.
- Never spill fuel in the vehicle or in the luggage compartment. Fuel vapour is explosive. Risk of fatal accident!

ⓘ CAUTION

- If any fuel is spilt onto the vehicle, it should be removed immediately. It could otherwise damage the paintwork.
- Never run the tank completely dry. The catalytic converter can be damaged.

🌿 For the sake of the environment

Do not overfill the fuel tank, it may cause the fuel to overflow if it becomes warm. »

Note

There is no emergency mechanism for the manual release of the fuel tank flap. If necessary, request assistance from specialised personnel.

Note

- If the pump nozzle is worn, damaged, or if it is very small, it is possible that it will not be able to open the protective device. Before trying to insert the pump nozzle by turning it, try a different pump or request specialist help.
- If you fill the tank from a reserve fuel canister, the protective device will not open. One way to resolve this is to pour the fuel in slowly.

Fuel types

Identification of fuels¹⁾

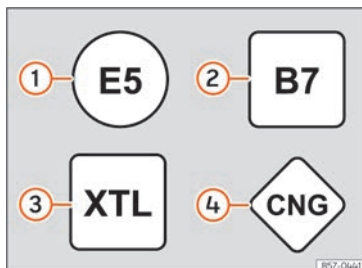


Fig. 282 Identification of fuels according to European Union (EU) Directive 2014/94/

Fuels are identified by different symbols on the pump and on your vehicle's tank flap. The identification serves to prevent confusion when choosing the fuel.

- 1) **Petrol** with ethanol ("E" stands for Ethanol). The number indicates the percentage of ethanol in the petrol. "E5" means, for example, an ethanol ratio of 5% max.

- 2) **Diesel** according to the EN590 standard. The number indicates the maximum percentage of Biodiesel in the fuel. "B7" means a maximum of 7% Biodiesel.
- 3) Synthetic **diesel** according to the EN15940 standard.
- 4) **Natural gas**: "CNG" means Compressed Natural Gas.

Type of petrol

✓ Valid for: vehicles with petrol engines

The correct grade of petrol is listed inside the fuel tank flap.

The vehicle is equipped with a catalytic converter and must only be run on **unleaded petrol**. The petrol must comply with the standard EN 228 and be **sulphur-free**. Fuels with a 10% ethanol ratio can be refuelled [E10]²⁾. The types of petrol are differentiated by using the **octane numbers (RON)** or via the **anti-knock index (AKI)**.

¹⁾ Depending on country

²⁾ Follow the regulations of the country you are driving in.

Super unleaded petrol 95 octane petrol or normal 91 octane petrol at least

We recommend refuelling with super 95 octane petrol (91 AKI). If not available, normal 91 octane petrol (87 AKI) (with a slight power loss) may be used.

Super unleaded petrol, 95 octanes at least

You should use super 95 octane petrol (91 AKI) at least.

If super is not available, *if necessary*, use normal 91 octane petrol (87 AKI). In this case only use moderate engine speeds and a light throttle. Refuel with super as soon as possible.

Unleaded super plus 98 octane petrol or super 95 octane petrol at least

We recommend refuelling with super plus 98 octane petrol (93 AKI). If not available: super 95 octane petrol (91 AKI) (with a slight power loss).

If super is not available, *if necessary*, use normal 91 octane petrol (87 AKI). In this case only use moderate engine speeds and a light throttle. Refuel with super as soon as possible.

CAUTION

- Fuels high percentage of ethanol, e.g. E30 - E100 button must not be used. The fuel system would be damaged. Exception: vehicles with Totalflex engine »» page 313, Ethanol fuel.
- A single refuelling with leaded fuel or other metal additives entails a permanent deterioration of the effectiveness of the catalytic converter.
- Only use fuel additives that have been approved by SEAT. The products that contain substances to increase the octane rating or decrease knocking may contain metal additives that damage the engine and catalytic converter. This type of products must not be used.
- Do not use fuels shown in the pump as containing metals. LRP (*lead replacement petrol*) fuels contain high concentrations of metal additives. Risk of engine damage!
- High engine speed and full throttle can damage the engine when using petrol with an octane rating lower than the correct grade for the engine.

Note

- Fuel with an octane rating higher than the one required by the engine can be used.

- In countries in which there is no sulphur-free fuel, it is also allowed to use low sulphur content fuel.

Ethanol fuel

✓ Valid for: vehicles with Totalflex engines

You can recognise vehicles with Totalflex engines¹⁾ by label on the fuel tank lid with the marking "Petrol/ethanol".

Vehicles with Totalflex engine can run with unleaded petrol (95 octane / 91 AKI) according to ANP No. 57 and with fuels with any high percentage of ethanol. The vehicle is refuelled in the same way as petrol refuelling.

Also consider that »» page 312, Type of petrol

Note

SEAT recommends filling the tank exclusively with petrol every 10,000 km to decrease impurities that using E100 ethanol fuel might have left in the engine.

¹⁾ This motor is only available in some markets.

Engine management and emissions control system

Introduction

WARNING

- Due to the high temperatures reached by the exhaust gas scrubbing system, you should not park your vehicle near a surface that can catch fire easily. Fire hazard!
- Do not apply wax underneath the vehicle around the area of the exhaust system: Fire hazard!

Control lamps

It lights up

Fault in the emission control system. Reduce speed and drive carefully to the nearest specialised workshop to have the engine checked.

Flashes

Combustion failures that can damage the catalytic converter. Reduce speed and drive carefully to the nearest specialised workshop to have the engine checked.

It lights up



Particulate filter blocked >>> page 314.

EPC It lights up

Fault in the petrol engine management. Have the engine checked as soon as possible by a specialised workshop.

When the ignition is switched on, the **EPC** (Electronic Power Control) lights up and should go off once the engine has started.


Note

While the indicator lamps ,  or **EPC** are on, there might be faults in the engine, fuel consumption may go up and the engine might lose power.

Catalytic converter

To maintain the useful life of the catalytic converter

- Always use unleaded petrol.
- Never run the fuel tank dry.
- When changing or adding engine oil, do not exceed the necessary amount >>> page 320, **Topping up the engine oil.**
- Never tow the vehicle to start it, use jump leads if necessary >>> page 51.

If you should notice misfiring, uneven running or loss of power when the car is moving, have the vehicle inspected by a specialised workshop. In general, the emissions warning lamp  will light up when any of these symptoms

occur. If this happens, any unburnt fuel can enter the exhaust system and escape into the atmosphere. The catalytic converter can also be damaged by overheating.


CAUTION

Never run the fuel tank completely dry because an irregular fuel supply can cause ignition faults. This allows unburnt fuel to enter the exhaust system, which could cause overheating and damage the catalytic converter.

For the sake of the environment

Even when the emission control system is working perfectly, there may be a smell of sulphur from the gases on occasions. This depends on the sulphur content of the fuel used. This can quite often be avoided by changing to another brand of fuel.

Particulate filter

The particulate filter eliminates most of the soot from the exhaust gas system. Under normal driving conditions the filter cleans itself. If the filter does not clean itself (e.g. if short journeys are made continuously), it becomes blocked with soot and the following indication is displayed to the driver:  **Particulate filter: cleaned while the vehicle is moving. See Manual.** The

particulate filter needs cleaning (regeneration).

Regeneration of the particulate filter

Requirements for the regeneration journey: the engine is at operating temperature.

- Drive at a speed of between 50-120 km/h (31-75 mph). This increases the temperature and burns the soot in the filter »» ⚠.
- Consider the legal speed limits as well as the recommended gears.
- End the regeneration journey once the control warning lamp has gone out.

If the warning lamp stays on after 30 minutes of running in regeneration mode, have a specialised workshop repair the fault

⚠ WARNING

Always adjust your speed to suit the weather conditions, roads, braking distance and traffic if the particulate filter is in its regeneration phase. Route recommendations should never make you disregard each country's specific traffic regulations.

ⓘ CAUTION

• When the exhaust system detects that the particulate filter is close to saturation, the self-cleaning function of this system recommends optimal driving for this function.

- Due to the high temperatures caused by the regeneration of the particulate filter, it is possible that the radiator fan will activate after stopping the engine, even if its operating temperature has not been reached.
- Noise, smells and high idle speeds can occur during regeneration.
- Always use the correct engine oil and the correct fuel to make sure the useful life of the particulate filter is not affected. Also avoid making short trips all the time.

Engine compartment

Working in the engine compartment

Always be aware of the danger of injury and scalding as well as the risk of accident or fire when working in the engine compartment (e.g. when checking and refilling fluids).

Always observe the warnings listed below and follow all general safety precautions.

The vehicle's engine compartment is a potentially hazardous area »» ⚠.

⚠ WARNING

When work is done in the engine compartment, injuries, burns, accidents and even fires can occur.

- Switch the engine off, remove the key from the ignition and apply the electronic parking brake. If the vehicle has a manual gearbox, place the lever in neutral; if it has an automatic gearbox, place the selector lever in position P. Wait for the engine to cool down.
- Never open the bonnet if you see steam or drips of coolant being released from the engine compartment. Wait until no steam or coolant can be seen before opening the bonnet.
- Keep children away from the engine compartment.
- Never spill liquids used for vehicle operation on the engine compartment, as these may catch fire (e.g. the antifreeze in coolant).
- Avoid causing short-circuits in the electrical system, particularly at the points where the jump leads are attached »» page 51. The battery could explode.
- If working inside the engine compartment, remember that, even when the ignition is switched off, the radiator fan may start up automatically, and therefore there is a risk of injury.

»

- Never cover the engine with additional insulating materials such as a blanket. Risk of fire!
- Do not unscrew the cap on the coolant expansion tank when the engine is hot. The cooling system is under pressure.
- Protect face, hands and arms by covering the cap with a large, thick rag to protect against escaping coolant and steam.
- Always make sure you have not left any objects, such as cleaning cloths or tools, in the engine compartment.
- If you have to work underneath the vehicle, you must use suitable stands additionally to support the vehicle, there is a risk of accident!. A hydraulic jack is insufficient for securing the vehicle and there is a risk of injury.
- If any work has to be performed when the engine is started or with the engine running, there is an additional, potentially fatal, safety risk from the rotating parts, such as the drive belts, alternator, radiator fan, etc., and from the high-voltage ignition system. You should also observe the following:
 - Never touch the electrical wiring of the ignition system.
 - Ensure that jewellery, loose clothing and long hair do not get trapped in rotating engine parts. Danger of death. Before starting any work remove jewellery, tie back and cover hair, and wear tight-fitting clothes.

- Never accelerate with a gear engaged without taking the necessary precautions. The vehicle could move, even if the handbrake is applied. Danger of death.
- Observe the following additional warnings if work on the fuel system or the electrical system is necessary:
 - Always disconnect the battery from the on-board network.
 - Do not smoke.
 - Never work near naked flames.
 - Always keep an approved fire extinguisher immediately available.



For the sake of the environment

- Inspect the ground underneath your vehicle regularly so that any leaks are detected at an early stage. If you find spots of oil or other fluids in the area where it was parked, have your vehicle inspected at the workshop.
- Service fluids leaks are harmful to the environment. For this reason you should make regular checks on the ground underneath your vehicle. If you find spots of oil or other fluids, have your vehicle inspected in a specialised workshop.

Opening and closing the bonnet

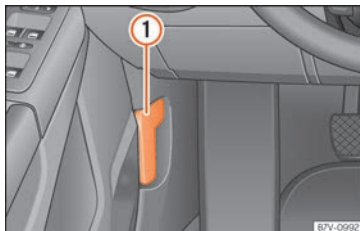


Fig. 283 Release lever in the driver's footwell area.



Fig. 284 Cam under the bonnet

Opening the bonnet

The bonnet is released from inside the vehicle.

Before opening the bonnet, make sure that the windscreen wiper arms are in place against the windscreen.

Checking and refilling levels

- Open the door and pull the lever under the dashboard »» Fig. 283 ①. The bonnet disengages from the locking of the protective lid due to the effect of a spring.
- Lift the bonnet using the opening lever »» Fig. 284 (arrow) and open the bonnet fully. The bonnet remains open thanks to the pressurised gas spring.

Closing the bonnet

- To close the bonnet, pull it down to overcome the gas strut pressure.

- Allow the bonnet to fall into the lock holder locking component from a distance of around 20 cm. *Don't push it!*

If the bonnet does not close, do not press downwards. Open it again and let it fall as mentioned above.

⚠ WARNING

Make sure that the bonnet is properly closed. If it opens when driving, it can cause an accident.

ⓘ CAUTION

To avoid damage to the bonnet and to the windscreen wiper arms, only open it when the windscreen wipers are in place against the windscreen.

Checking levels

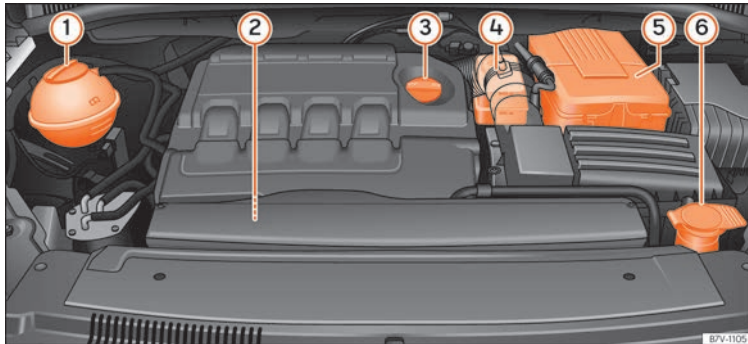


Fig. 285 Diagram for the location of the various elements. »

From time to time, the levels of the different fluids in the vehicle must be checked. Never fill with incorrect fluids, otherwise serious damage to the engine may be caused.

- ① Coolant expansion tank »» page 321
- ② Engine oil level dipstick »» page 320
- ③ Engine oil filler cap »» page 320
- ④ Brake fluid reservoir »» page 323
- ⑤ Battery (under the cover) »» page 325
- ⑥ Windscreen washer reservoir »» page 324

Note

The layout of parts may vary depending on the engine.

Engine oil

General notes

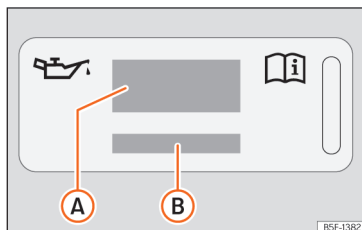


Fig. 286 In the engine compartment: engine oil label

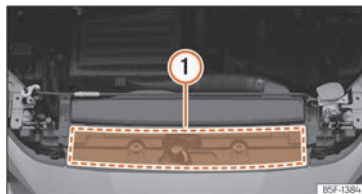


Fig. 287 In the engine compartment: area where the engine oil label is located

Key to the »» **Fig. 286:**

- A** Information about the engine oil standard.
- B** Information about engine oil viscosity.

The engine comes with a special, multi-grade oil that can be used all year round.

Because the use of high-quality oil is essential for the correct operation of the engine and its long useful life, when topping up or changing oil, use only those oils that comply with VW standards.

For vehicles with an engine oil label

If the engine oil has to be topped up, use one of the oils shown on the label »» **Fig. 286**. The label with the prescribed standard is located at the front of the engine compartment »» **Fig. 287** ①. If you use the recommended engine oil, you can top up the oil as often as necessary.

For vehicles without an engine oil label

Contact a specialised workshop or SEAT official service for information about the corresponding standard.

If the engine oil level is too low

If the recommended engine oil is not available, in the event of an **emergency** you can change the oil **once** with a maximum of 0,5 L of the next oil until the next oil change:

- *Petrol and CNG engines:* VW 504 00, ACEA C3 or API SN standard.

SEAT recommends changing the oil at a specialised workshop. SEAT recommends an Official SEAT Service.

SEAT recommends the use of engine oils approved according to the appropriate VW standard. Use of engine oils that do not meet these quality requirements can cause engine damage.

SEAT recommends the use of Original SEAT Spare Part engine oils.

Engine oil additives

No type of additive should be mixed with the engine oil. The deterioration caused by these additives is not covered by the warranty.

CAUTION

Take the following into account if you have refilled with an engine oil different to those specified in the aforementioned standards, or by your SEAT technical service centre:

- There is no way of completely avoiding the danger of causing damage to the engine and particulate filter.
- You can continue driving with the vehicle if the refill was no more than 0.5 l of engine oil. Go to a specialised workshop as soon as possible and request an oil change. Otherwise, there is a danger of engine damage.
- If you have topped up more than 0.5 l of engine oil, drive with the engine at low load

levels and within the medium RPM range as a maximum. Do not drive at more than 80 km/h and do not travel more than 300 km (approximately). Go to a specialised workshop as soon as possible and request an oil change. Otherwise, there is a danger of engine damage.


- You are responsible for the risk of possible damage to the vehicle (engine, exhaust system). If in doubt, do not start the engine and request assistance from the technical service centre.
- Do not start the engine if you have topped up with a fluid other than engine oil. Request assistance from the technical service centre. Danger of engine damage!


Note

Before a long trip, we recommend finding an engine oil that conforms to the corresponding VW specifications and recommend keeping it in the vehicle. This way, the correct engine oil will always be available for a top-up if needed.

Warning lamp

Flashes red

 **Do not carry on driving!**
Engine oil pressure too low.
Switch off the engine. Check the engine oil level.

If the warning lamp  flashes although the oil level is correct, stop driving. Do not even run the engine at idle speed! Obtain technical assistance.


It lights up yellow

Check the engine oil level as soon as possible. Replace oil as soon as you have the opportunity to do so »» page 320.

It flashes yellow

Fault in the oil level sensor.
Have the check done by a specialised workshop. Until then it is advisable to check the oil level every time you refuel.

WARNING

Observe the safety warnings »»  in Control and warning lamps on page 88.

Checking the engine oil level

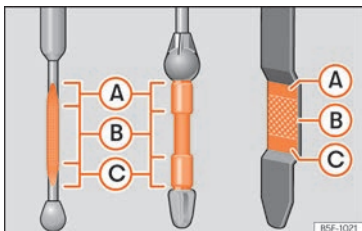


Fig. 288 Engine oil dipstick.

The engine oil dipstick indicates the level of the oil.

Checking oil level

- Park the vehicle in a horizontal position.
- Briefly run the engine at idle speed until the operating temperature is reached and then stop.
- Wait for about two minutes.
- Pull out the dipstick. Wipe the dipstick with a clean cloth and insert it again, pushing it in as far as it will go.
- Then pull it out once more and check the oil level »» **Fig. 288**. Top up with engine oil if necessary.

The oil must leave a mark between zones **A** and **C**. It can never go above zone **A**.

- Zone **A**: do not add oil.
- Zone **B**: you can add oil but keep the level in that zone.
- Zone **C**: add oil until zone **B**.

Depending on how you drive and the conditions in which the vehicle is used, oil consumption can be up to 0.5 l/1000 km. Oil consumption is likely to be higher for the first 5,000 km. For this reason the engine oil level must be checked at regular intervals, preferably when filling the tank and before a journey.

⚠ WARNING

Any work carried out in the engine compartment or on the engine must be carried out cautiously.

- When working in the engine compartment, always observe the safety warnings »» page 315.

ⓘ CAUTION

If the oil level is above area **A, do not start the engine. This could result in damage to the engine and catalytic converter. Contact a Technical Service.**

Topping up the engine oil



Fig. 289 In the engine compartment: Engine oil filler cap.

Before opening the bonnet, read and observe the warnings »» **⚠** in **Working in the engine compartment** on page 315.

Topping up engine oil

- Unscrew cap from engine oil filler opening »» **Fig. 289**.
- Carefully add oil in small quantities (no more than 0.5 l).
- To avoid adding too much oil, whenever you add a certain amount, wait about 2 minutes and recheck the oil level »» page 320.
- If necessary, add some more oil.
- When the oil level reaches at least zone »» **Fig. 288 B**, unscrew the engine oil filler cap carefully »» ⓘ.


The position of the oil filler opening is shown in the corresponding engine compartment illustration »» page 317.

Engine oil specification »» page 318.


WARNING

Oil is highly inflammable! Ensure that no oil comes into contact with hot engine components when topping up.

CAUTION

If the oil level is above area »» Fig. 288 , do not start the engine. This could result in damage to the engine and catalytic converter. Contact a specialised workshop.

For the sake of the environment

The oil level must never be above zone »» Fig. 288 . Otherwise oil can be drawn in through the crankcase breather and leak into the atmosphere via the exhaust system.

Note

Before a long trip, we recommend finding an engine oil that conforms to the corresponding VW specifications and recommend keeping it in the vehicle. This way, the correct engine oil will always be available for a top-up if needed.

Engine oil change

We recommend that you have the engine oil changed by a Technical Service.

WARNING

Only change the engine oil yourself if you have the specialist knowledge required!

- Before opening the bonnet, read and observe the warnings »» page 315.
- Wait for the engine to cool down. Hot oil may cause burn injuries.
- Wear eye protection to avoid injuries, such as acid burns, caused by splashes of oil.
- When removing the oil drain plug with your fingers, keep your arm horizontal to help prevent oil from running down your arm.
- Wash your skin thoroughly if it comes into contact with engine oil.
- Engine oil is poisonous! Used oil must be stored in a safe place out of the reach of children.

CAUTION

No additives should be used with engine oil. This could result in engine damage. Any damage caused by the use of such additives would not be covered by the factory warranty.

For the sake of the environment

- We recommend that you change the engine oil and the filter at a technical service centre.
- Never pour oil down drains or into the ground.
- Use a suitable container when draining the used oil. It must be large enough to hold all the engine oil.

Cooling system

Coolant specifications

The engine cooling system is supplied from the factory with a specially treated mixture of water and at least 40 % of the additive **G12evo** (TL-VW 774 J), purple. This mixture gives the necessary frost protection down to -25°C (-13°F) and protects the light alloy parts of the engine cooling system against corrosion. It also prevents scaling and considerably raises the boiling point of the coolant.

To protect the cooling system, the percentage of additive must always be at least 40 %, even in warm climates where anti-freeze protection is not required.

If for weather reasons further protection is necessary, the proportion of additive may be »

increased, but only up to 60 %; otherwise anti-freeze protection will diminish and this will worsen cooling.

When the coolant is topped up, use a mixture of **distilled water** and at least 40 % of the additive **G12evo** for optimal protection against corrosion. Mixing **G12evo** with G13 (TL-VW 774 J), G12 plus-plus (TL-VW 774 G), G12 plus (TL-VW 774 F), G12 (red) or G11 (green blue) engine coolants decreases protection against corrosion and should be avoided.

⚠ WARNING

If there is not enough anti-freeze in the coolant system, the engine may fail leading to serious damage.

- Ensure that the percentage of additive is correct for the lowest expected ambient temperature in the zone in which the vehicle is to be used.
- When the outside temperature is very low, the coolant could freeze and the vehicle would be immobilised.

ⓘ CAUTION

The original additives should never be mixed with coolants which are not approved by SEAT.

- If the fluid in the expansion tank is not purple but is, for example, brown, this indicates that the G12evo additive has been

mixed with an inadequate coolant. The coolant must be changed as soon as possible if this is the case!

♻ For the sake of the environment

Coolants and additives can contaminate the environment. If any fluids are spilled, they should be collected and correctly disposed of, with respect to the environment.

Refilling coolant

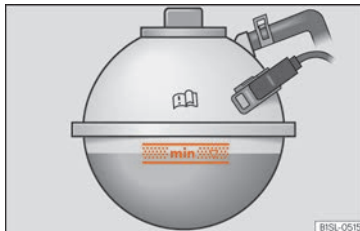


Fig. 290 In the engine compartment: marking on coolant expansion tank.



Fig. 291 Engine compartment: coolant expansion tank cap.

The coolant tank is located in the engine compartment »» page 317.

Top up coolant when the level is below the **MIN** (minimum) mark.

Checking coolant level

- Park the vehicle in a horizontal position.
- Switch the ignition off.
- Read off the coolant level on coolant expansion tank. When the engine is cold, the coolant level should be between the marks »» Fig. 290. When the engine is hot, it may be slightly above the upper mark.

Topping up coolant

- Wait for the engine to cool down.

- Cover the coolant expansion tank cap with a cloth and carefully unscrew it to the left »» ⚠.
- Top up the coolant only if there is still coolant in the expansion tank, otherwise you could **damage the engine**. If there is no coolant in the expansion tank, do not continue driving. You should obtain professional assistance »» ⚠.
- If there is still some coolant in the expansion tank, top up to the upper mark.
- Top up with coolant until the level becomes stable.
- Screw the cap back on correctly.

If there is a coolant leak, take the vehicle specialised workshop to have the cooling system examined.

⚠ WARNING

- The cooling system is under pressure. Do not unscrew the cap on the coolant expansion tank when the engine is hot: risk of burns!
- Store the antifreeze in its original container and keep it out of reach of children.
- If working inside the engine compartment, remember that, even when the ignition is switched off, the radiator fan may start up automatically, and therefore there is a risk of injury.

⚠ CAUTION

If you run out of coolant in the expansion tank, park the car in a safe place and do not continue driving. Obtain technical assistance.

Brake fluid

Check and refill the brake fluid



Fig. 292 Engine compartment: brake fluid reservoir cap.

The brake fluid reservoir is located in the engine compartment »» page 317.

Checking the brake fluid level

The brake fluid level must be between the **MIN** and **MAX** markings.

However, if the brake fluid level goes down noticeably in a short time, or drops below the **MIN** mark, there may be a leak in the brake system. Seek specialist assistance. A warning light on the instrument panel display monitors the brake fluid level »» page 87.

Changing brake fluid

We recommend that you have the brake fluid changed by a Technical Service.

⚠ WARNING

If the brake fluid level is low or unsuitable/old brake fluid is used, the brake system may fail or braking power may be reduced.

- Check the brake system and the brake fluid level regularly!
- When the brake fluid is used and brakes are subjected to extreme braking forces, bubbles of vapour form in the brake system. These bubbles can significantly reduce braking power, notably increasing braking distance, and could result in the total failure of the brake system.
- Be sure to always use the correct brake fluid. Only use brake fluid that expressly meets the VW 501 14 standard.
- You can buy VW 501 14 standard brake fluid in a SEAT dealership or a SEAT Official Service. If none is available, use only high-quality brake fluid that meets DIN ISO 4925 »»

CLASS 4 standards, or USA Standards FMVSS 116 DOT 4.

- The replacement brake fluid must be new.
- Brake fluid should be stored in the closed original container in a safe place out of reach of children. Risk of poisoning!

ⓘ CAUTION

Brake fluid should not come into contact with the vehicle paintwork, as it is abrasive.

♻️ For the sake of the environment

Brake fluid is an environmental pollutant. Collect any spilt service fluids and allow a professional to dispose of them.

Windscreen washer reservoir

Checking the level of the window washer tank and refilling it



Fig. 293 In the engine compartment: blue cap of the windscreen washer tank.

The window washer tank is in the engine compartment »»» page 317.

Check the water level in the windscreen washer reservoir regularly and top up as required.

The container for the windscreen washer contains the cleaning fluid for the windscreen, the rear window and the headlight washer system.

- Open the bonnet ▲ »»» page 315.
- The window washer tank is marked with the ♻️ symbol on the cap.

- Check there is enough windscreen water in the reservoir.

Plain water is not enough to clean the windscreen and headlights. We recommend that you always add a product to the windscreen washer fluid.

Recommended windscreen wipers

- For the hottest seasons we recommend summer G 052 184 A1 for clear glass. Proportions of the mixture in the washer fluid tank: 1:100 (1 part concentrate per 100 parts water).
- All year round, G 052 164 A2 for clear glass. Approximate proportion of the winter mixture, up to -18°C (0°F): 1:2 (1 part concentrate per 2 parts water); otherwise, a 1:4 proportion of mixture in the washer fluid tank.

The capacity of the window washer tank can be found in »»» page 357.

ⓘ CAUTION

If the water from the windscreen washer does not contain enough anti-freeze, it may freeze on the windscreen and rear window, reducing forward and rear visibility.

- In winter, ensure the windscreen washer contains enough anti-freeze.
- In cold conditions, you should not use the windscreen wiper system unless you have

warmed the windscreen with the ventilation system. The antifreeze could freeze on the windscreen and reduce visibility.

ⓘ CAUTION

Never mix an unsuitable antifreeze or other similar additives with the windscreen washer water. A greasy layer may be formed on the windscreen which will impair visibility.

- Use clean water with a window cleaner recommended by SEAT.
- If necessary, add a suitable antifreeze to the water in the reservoir.

ⓘ CAUTION

- Do not mix cleaning products recommended by SEAT with other products. This could lead to flocculation and may block the windscreen washer jets.
- When topping up service fluids, make absolutely certain that you fill the fluids into the correct reservoirs. Using the wrong fluids could cause serious malfunctions and engine damage!
- Not having windscreen wiper fluid reduces visibility through the windscreen, and leads to loss of visibility in headlights in models with headlight washer.

12-volt battery







General information

The battery is located in the engine compartment and is almost **maintenance-free**. It is checked as part of the Inspection Service. Nevertheless, check the terminals are clean and have the correct tightening torque, especially in summer and winter.

All work on batteries requires specialist knowledge. Please refer to a SEAT Official Service or a workshop specialising in batteries: risk of burns or exploding battery!

The battery must not be opened. Never try to change the fluid level of the battery. Otherwise explosive gas is released from the battery that could cause an explosion.

Battery warning indications

	Wear eye protection.
	Battery acid is extremely corrosive. Wear protective gloves and eye protection. Rinse any splashes of electrolyte with plenty of water.
	Fires, sparks, open flames and smoking are prohibited.
	The battery should only be charged in a well-ventilated zone. Risk of explosion!
	Keep children away from acid and batteries!
	Always follow the instruction manual.

Disconnecting the battery

The battery should only be disconnected in exceptional cases. When the battery is disconnected, some of the vehicle's functions are lost. These functions will require resetting after the battery is reconnected.

When disconnecting the battery from the vehicle on-board network, disconnect first the negative cable and then the positive cable.

Deactivate the anti-theft alarm before you disconnect the battery. Otherwise the alarm will be triggered.

Winter conditions

During the winter, the starting power may be reduced, and if necessary, the battery should be charged »» ⚠

⚠ WARNING

Always be aware of the danger of injury and chemical burns as well as the risk of accident or fire when working on the battery and the electrical system:

- Wear eye protection. Protect your eyes, skin and clothing from acid and particles containing lead.
- Battery acid is extremely corrosive. Wear protective gloves and eye protection. Do not tilt the batteries. This could spill acid through the vents.
- Neutralise any electrolyte splashes on the skin, eyes or clothing with a soapy »

solution, and rinse off with plenty of water. If acid is swallowed by mistake, consult a doctor immediately.

- Fires, sparks, open flames and smoking are prohibited. When handling cables and electrical equipment, avoid causing sparks and electrostatic charge. Never short the battery terminals. High-energy sparks can cause injury.
- A highly explosive mixture of gases is released when the battery is under charge. The batteries should be charged in a well-ventilated room only.
- Keep children away from acid and batteries.
- Before working on the electrical system, you must switch off the engine, the ignition and all electrical devices. The negative cable on the battery must be disconnected. When a light bulb is changed, you need only switch off the light.
- Deactivate the anti-theft alarm by unlocking the vehicle before you disconnect the battery! The alarm will otherwise be triggered.
- When disconnecting the battery from the vehicle on-board network, disconnect first the negative cable and then the positive cable.
- Switch off all electrical devices before reconnecting the battery. Reconnect first the positive cable and then the negative cable. Never reverse the polarity of the

connections. This could cause an electrical fire.

- Never charge a frozen battery, or one which has thawed. This could result in explosions and chemical burns. Always replace a battery which has frozen. A flat battery can also freeze at temperatures close to 0°C (+32°F).
- Ensure that the vent hose is always connected to the battery.
- Never use a defective battery. This could cause an explosion. Replace a damaged battery immediately.

⚠ CAUTION


- Do not expose the battery to direct sunlight over a long period of time, as the intense ultraviolet radiation can damage the battery housing.
- If the vehicle is left standing in cold conditions for a long period, protect the battery from "freezing". If it freezes it will be damaged.

Warning lamp

 It lights up red

Alternator fault.

The control lamp lights up when the ignition is switched on. It should go out when the engine has started running.

If the control lamp  lights up while driving, the alternator is no longer charging the battery. You should immediately drive to the nearest specialised workshop.

You should avoid using electrical equipment that is not absolutely necessary because this will drain the battery.

Checking the battery electrolyte level

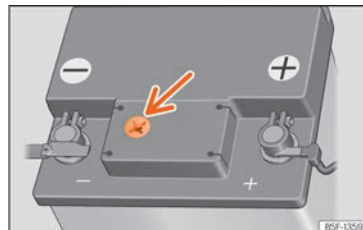


Fig. 294 Sight glass on the top of the 12 volt battery [schematic representation].

The electrolyte level should be checked regularly in high-mileage vehicles, in hot countries and in older batteries.

- Open the bonnet and then lift the cover that protects the front part of the battery
» **△ in Working in the engine compartment on page 315.**
- Check the colour display in the "magic eye" on the top of the battery.
- If there are air bubbles in the window, tap the window gently until they disperse.

The position of the battery is shown in the corresponding engine compartment diagram
» **page 317.**

The "magic eye" indicator, located on the top of the battery changes colour, depending on the charge state and electrolyte level of the battery.

There are two different colours:

Yellow or colourless: The battery's electrolyte level is too low. Go to a specialised workshop to have the battery checked and replaced if necessary.

Black: The battery's electrolyte level is correct.

Charging or changing the battery

If you often drive short distances or if the vehicle is not driven for long periods, the battery should be checked by a specialised workshop between the scheduled services.

If the battery has discharged and you have problems starting the vehicle, the battery might be damaged. If this happens, we recommend you have the vehicle battery checked by a Technical Service where it will be re-charged or replaced.

Charging the battery

The vehicle battery should be charged by a specialised workshop only, as batteries using special technology have been installed and they must be charged in a controlled environment.

Replacing a vehicle battery

The battery has been developed to suit the conditions of its location and has special safety features. If the battery must be replaced, consult a technical service for information on electromagnetic compatibility, the size and maintenance, performance and safety requirements of the new battery in your vehicle before you purchase one. SEAT recommends you have the battery replaced by a technical service.

Start-Stop systems (» **page 245**) are equipped with a special battery. Therefore, it must only be replaced with a battery of the same specifications.

Automatic disconnection of devices

The intelligent vehicle electrical system automatically implements a range of measures to prevent the battery from discharging when high demands are made on it:

- the idling speed is increased so that the alternator provides more electricity.
- where necessary, the power of the most powerful devices is reduced or even completely disconnected.
- On starting the engine, the power supply from the 12-volt power sockets and the cigarette lighter may be interrupted for a short time.

The on-board management program cannot always prevent the battery from running flat. For example, if the ignition is left on for a long period with the engine off or if the side lights or parking lights are left on while the vehicle is stationary.

△ WARNING

- **Always use only maintenance free batteries that do not run flat alone and whose properties, specifications and size correspond to the standard battery. The specifications are indicated on the battery case.**
- **Before starting any work on the batteries, you must read and observe the warnings**
» **△ in General information on page 325.**

**For the sake of the environment**

⚠ Batteries contain toxic substances such as sulphuric acid and lead. They must be disposed of appropriately and must not be disposed of with ordinary household waste.

Wheels

Wheels and tyres

Introduction

The SEAT Alhambra is equipped as standard with anti-puncture technology tyres (Conti-Seal). In the event of a puncture or air leak of up to 5 mm, the tyre seals the hole with a protective layer inside the tread.

The inclusion of this technology means that there is no type of spare wheel included in the vehicle's equipment.

SEAT recommend that all work on tyres and wheels is carried out by a specialised workshop. These workshops have the necessary special tools and replacement parts, trained personnel and facilities for disposing of the old tyres while respecting the environment. SEAT recommends taking your car in for technical service.

General notes

- When driving with **new tyres**, be especially careful during the first 500 km (300 miles).
- If you have to drive over a kerb or similar obstacle, drive very slowly and as near as possible at a right angle to the obstacle.

- Check from time to time if the tyres are damaged (punctures, cuts, cracks or dents). Remove any foreign objects embedded in the treads.
- Damaged wheels and tyres must be replaced immediately.
- Keep grease, oil and fuel off the tyres.
- Replace any missing valve caps as soon as possible.
- Mark the wheels before taking them off so that they rotate in the same direction when put back.
- When removed, the wheels or tyres should be stored in a cool, dry and preferably dark place.

Low profile tyres

Low profile tyres have a wider tread, a larger wheel diameter and a lower sidewall height. Therefore, its driving behaviour is more agile.

Low profile tyres may deteriorate more quickly than standard tyres, for instance due to strong knocks, potholes, manhole covers and kerbs. Correct tyre pressure is very important »» page 331.

To avoid damage to tyres and wheels, drive with special care when driving on roads in poor condition.

Visually check your wheels every 3000 km.

If the tyres or rims have received a heavy impact or have been damaged, have a specialised workshop check whether or not it is necessary to change the tyre.

Low profile tyres may deteriorate more quickly than standard tyres.

Concealed damage

Damage to tyres and rims is often not readily visible. If you notice unusual **vibration** or the car **pulling to one side**, this may indicate that one of the tyres is damaged. Reduce speed immediately if there is any reason to suspect that damage may have occurred. Inspect the tyres for damage. If no external damage is visible, drive slowly and carefully to the nearest specialised workshop and have the car inspected.

Foreign objects inserted in the tyre

- Do not remove foreign bodies if they have penetrated through the tyre wall!
- If the vehicle comes with a tyre mobility system, where necessary seal the damaged tyre as shown in section »» page 42. Use a specialised workshop for repair or replacement. SEAT recommends visiting a SEAT dealership for this.

The sealant at the lower part of the tyre tread wraps around the foreign body and provisionally seals the tyre.

Tyres with directional tread pattern

An arrow on the tyre sidewall indicates the direction of rotation on single drive tyres. Always note the direction of rotation indicated when mounting the wheel. This makes sure that optimal use is made of tyre properties in terms of aquaplaning, grip, excessive noise and wear.

Subsequent fitting of accessories

If you wish to change or fit wheels, rims or wheel trims, we recommend that you consult with a SEAT Official Service centre for advice regarding current techniques.

Speed symbols

The speed rating indicates the maximum speed permitted for the tyres.

P	max. 150 km/h [93 mph]
Q	max. 160 km/h [99 mph]
R	max. 170 km/h [106 mph]
S	max. 180 km/h [112 mph]
T	max. 190 km/h [118 mph]
U	max. 200 km/h [124 mph]
H	max. 210 km/h [130 mph]
V	max. 240 km/h [149 mph]
Z	max. 240 km/h [149 mph]
W	max. 270 km/h [168 mph]
Y	max. 300 km/h [186 mph]

Some manufacturers use the letters "ZR" for tyres with a maximum authorised speed above 240 km/h [149 mph].


⚠ WARNING

- **New tyres do not have maximum grip during the first 500 km. Drive particularly carefully to avoid possible accidents.**
- **Never drive with damaged tyres. This may cause an accident.**
- **If you notice unusual vibrations or if the vehicle pulls to one side when driving, stop the vehicle immediately and check the tyres.**
- **Never use old tyres or those with an unknown history of use.**

New wheels and tyres

It is best to have all wheels and tyres serviced by a specialised workshop. There they have the required knowledge, the special tools and the corresponding spare parts.

- Even winter tyres lose their grip on ice. If you have installed new tyres, drive the first 500 km carefully and at a moderate speed.
- All four wheels must be fitted with tyres of the same type, size [rolling circumference] and, if possible, tread pattern.
- When changing tyres, do not change just one; change at least two on the same axle. »

- If you want to equip your vehicle with a combination tyres and rims that are different to those fitted in the factory, inform your specialised workshop before purchasing them
»» 

The sizes of the rims and tyres approved for your vehicle are listed in the vehicle documentation (e.g. EC Certificate of Conformity or COC document¹⁾). The vehicle documentation varies depending on the country of residence.

If the type of spare wheel is different from the normal wheels — e.g. in the case of winter tyres or particularly wide tyres — the spare wheel should only be used temporarily in the event of a puncture, and the vehicle should be driven with care. Refit the normal road wheel as soon as possible.

In vehicles with four-wheel drive, the 4 wheels must be fitted with tyres of the same brand, type and tread so that the traction system is not damaged by a difference in the number of turns of the wheels. Therefore, in the event of a puncture, only a spare wheel with the same perimeter as normal tyres should be used.

Manufacturing date

The manufacturing date is also indicated on the tyre sidewall (or on the inside face of the wheel):

DOT ... 2218 ...

it means, for example, that the tyre was manufactured in the 22nd week of 2018.

WARNING

- Use only combinations of tyres and rims, as well as suitable wheel nuts, approved by SEAT. Otherwise the vehicle may be damaged, causing an accident.
- For technical reasons it is not possible to use wheels of other vehicles; in some cases not even wheels from the same vehicle model should be used.
- Always ensure that the tyres you have chosen have adequate clearance. When selecting replacement tyres, do not rely entirely on the nominal tyre size marked on the tyre, since the nominal tyre size can differ significantly depending on the manufacturer. Lack of clearance can damage the tyres or the vehicle and, as a result, endanger road safety. Risk of accident!
- Only use tyres that are over 6 years old in an emergency, and drive with due care.
- The fitting of tyres with run-flat properties is not permitted on your vehicle! Pro-

hibited use can cause accidents or can damage your vehicle.

- If decorative hubcaps are subsequently fitted, make sure that they allow enough air in to cool the braking system. Risk of accident!

For the sake of the environment

Old tyres must be disposed of according to the laws in the country concerned.

Note

- A SEAT Service Centre should be consulted to find out whether wheels or tyres of different sizes to those originally fitted by SEAT can be fitted, and to find out about the combinations allowed between the front axle (axle 1) and the rear axle (axle 2).
- Never mount used tyres if you are not sure of their “previous history”.

¹⁾ COC = certificate of conformity.

Tyre life

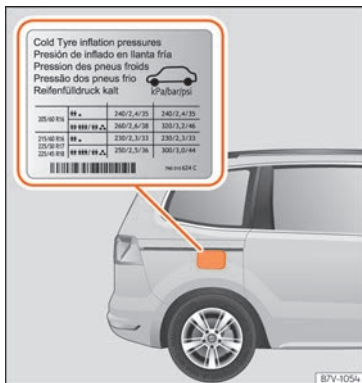


Fig. 295 Position of tyre pressure specification plate

Correct inflation pressures and sensible driving habits will increase the useful life of your tyres.

- Check tyre pressure at least once a month, and also prior to any long trip.
- The tyre pressure should only be checked when the tyres are *cold*. Do not reduce the pressure of warm tyres.
- Adjust tyre pressure to the load being carried by the vehicle »» **Fig. 295**.
- Avoid fast cornering and hard acceleration.

- Inspect the tyres for irregular wear from time to time.

Tyre pressure

The correct tyre pressures for tyres fitted at the factory is shown on a label and is valid for summer and winter tyres. This label

»» **Fig. 295** is either on the driver door strut or inside the fuel tank flap.

Insufficient or excessive pressure greatly reduces the useful life of the tyres and adversely affects vehicle performance and ride. Correct inflation pressures are very important, especially at **high speeds**.

The tyre pressure must be adjusted according to the load the vehicle is carrying. If the vehicle is going to carry the maximum load, the tyre pressure should be increased to the maximum value indicated on the sticker

»» **Fig. 295**.

Driving style

Fast cornering, heavy acceleration and hard braking (squealing tyres) all increase tyre wear.

Wheel balance

The wheels on new vehicles are balanced. However, certain circumstances may lead to imbalance (run-out), which is detected as vibrations in the steering wheel.

Unbalanced wheels should be rebalanced, as they otherwise cause excessive wear on steering, suspension and tyres. A wheel must also be rebalanced when a new tyre is fitted or if a tyre is repaired.

Incorrect wheel alignment

Incorrect running gear alignment causes excessive tyre wear, impairing the safety of the vehicle. If you notice excessive tyre wear, you should check wheel alignment at a SEAT Official Service.

⚠ WARNING

Unsuitable handling of the wheels and tyres may lead to sudden tyre pressure losses, to tread separation or even to a blow-out.

- The driver is responsible for ensuring that all of the vehicle tyres are correctly inflated to the right pressure. The recommended tyre pressure is indicated on the label »» **Fig. 295**.
- Check tyre pressures regularly and ensure they are maintained at the pressures indicated. Tyre pressure that is too low could cause overheating, resulting in tread detachment or even burst tyres.
- When the tyres are cold, tyre pressure should be that indicated on the label »» **Fig. 295**.
- Regularly check the cold inflation pressure of the tyres. If necessary, change the

»

tyre pressure of the vehicle tyres while they are cold.

- Regularly check your tyres for damage and wear.
- Never exceed the maximum permitted speed or loads specified for the type of tyre fitted on your vehicle.

For the sake of the environment

Under-inflated tyres will increase fuel consumption.

Tread wear indicators



Fig. 296 Tyre profile: tread wear indicators.

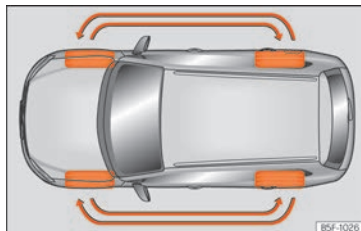



Fig. 297 Interchanging tyres.

Wear indicators around 1.6 mm high can be found on the base of the original tyre treads, ordered at regular intervals and running across the tread »» Fig. 296. The letters "TWI" or triangles on the sidewall of the tyre mark the position of the wear indicators.

The minimum permitted profile depth¹⁾ have been reached when the tyres have worn down to the wear indicators. Replace the tyres with new ones »» .

Changing wheels around

To ensure that the wear is equal on all tyres the wheels should be changed round from time to time according to the system »» Fig. 297. The useful life of all the tyres will then be about the same time.

WARNING

The tyres must be replaced at the latest when the tread is worn down to the tread wear indicators. Failure to follow this instruction could result in an accident.

- Particularly in difficult driving conditions such as wet or icy roads. It is important that the tyre tread be as deep as possible and be approximately the same on the tyres of both the front and the rear axles.
- The scant driving safety due to insufficient tread depth is particularly evident in vehicle handling, when there is a risk of "aquaplaning" in deep puddles of water and when driving through corners, and braking is also adversely affected.
- The speed has to be adapted accordingly, otherwise there is a risk of losing control over the vehicle.

Wheel nuts

The **wheel nuts** are matched to the rims. When installing different wheels (for instance alloy wheels or wheels with winter tyres) it is important to use the correct wheel nuts with the right length and correctly shaped bolt

¹⁾ Follow the regulations of the country you are driving in.

heads. This ensures that wheels are fitted securely and that the brake system functions correctly.

The wheel nuts must be clean and turn easily.

A special adapter is required to remove the anti-theft wheel bolts » page 46.

⚠ WARNING

Wheel nuts should never be greased or oiled.

- Use only wheel nuts which belong to the wheel.
- If the prescribed torque of the wheel nuts is too low, they could loosen whilst the vehicle is in motion. Risk of accident! If the tightening torque is too high, the wheel nuts and threads can be damaged.

ⓘ CAUTION

See » page 49 to find out the recommended tightening torque for wheel nuts for steel and alloy rims.

Winter tyres

- Winter tyres must be fitted **on all four** wheels.

- Only use winter tyres that are approved for your vehicle.
- Please note that the maximum permissible speed for winter tyres may be lower than for summer tyres.
- Also note that winter tyres are no longer effective when the **tread** is worn down.
- After fitting the wheels you must always check the tyre pressures. When doing so, take into account the correct tyre pressures listed on the rear of the front left door frame » page 331.

In winter road conditions winter tyres will considerably improve vehicle handling. The design of summer tyres (width, rubber compound, tread pattern) gives less grip on ice and snow. This applies particularly to vehicles equipped with **wide section tyres** or with **high speed tyres** (code letters H, V or Y on the sidewall).

Only use winter tyres of the correct type approved for your vehicle. The sizes of these tyres are specified in the vehicle's documents (e.g. EC Certificate of Conformity or COC¹⁾). The vehicle documentation varies depending on the country of residence.

Winter tyres lose a great deal of their properties when the **tread** is worn down to a depth of 4 mm.

The performance of winter tyres is also severely impaired by **ageing**, even if the tread is still much deeper than 4 mm.

A code letter indicating the speed limit is stamped on all winter tyres » page 329.

Vehicles capable of exceeding these speeds must have an appropriate **sticker** attached so that it is visible to the driver. Suitable stickers are available from the SEAT Official Service and specialised workshop. Please note the regulations to this effect in your country.

Using winter tyres with V-rating

Please note that the generally applicable 240 km/h (149 mph) speed for winter tyres with the letter V is subject to **technical restrictions; the maximum permissible speed for your vehicle may be significantly lower**. The maximum speed limit for these tyres depends directly on the maximum axle weights for your car and on the listed weight rating of the tyres being used.

It is best to contact a SEAT Official Service to check the maximum speed which is permissible for the V-rated tyres fitted on your car on the basis of this information. »

¹⁾ COC = certificate of conformity.


WARNING

Exceeding the maximum speed permitted for the winter tyres fitted on your car can cause tyre failure, resulting in a loss of control of the vehicle – risk of accident.

For the sake of the environment

When winter is over, change back to summer tyres at an appropriate moment. In temperatures above +7°C [+45°F], performance will be improved if summer tyres are used. Fuel consumption, wear and noises while driving will all be reduced.

Note

All-weather tyres can also be used instead of winter tyres. Please note that only winter tyres with the symbol  may be fitted in some countries where winter tyres are mandatory.

Snow chains

Snow chains must only be fitted to **the front wheels**, even on vehicles with **four-wheel drive**.

- Check that they are correctly seated after driving for a few yards; correct the position if necessary, in accordance with the manufacturer's fitting instructions.

- Keep your speed below 50 km/h (30 mph).
- If there is a danger of being trapped despite having mounted the chains, it is best to disable the driving wheels (ASR) in the ESC **>>> page 289, Connecting and disconnecting the ASR.**

Snow chains will improve *braking ability* as well as *traction* in winter conditions.

For technical reasons snow chains may only be used with the following wheel rim/tyre combination.

Tyres	Wheel rim	Chains
205/60 R16	6.5Jx16 ET33	Max. link 15 mm
Other dimensions do not allow chains		

Remove any central wheel trims and the rim ring before fitting snow chains.

WARNING

The use of unsuitable or incorrectly fitted chains could lead to serious accidents and damage.

- Always the appropriate snow chains.
- Observe the fitting instructions provided by the snow chain manufacturer.
- Never exceed the maximum permitted speeds when driving with snow chains.

CAUTION


- Remove the snow chains to drive on roads without snow. Otherwise they will impair vehicle handling, damage the tyres and wear out very quickly.
- Wheel rims may be damaged or scratched if the chains come into direct contact with them. SEAT recommends the use of covered snow chains.

Tyre pressure monitor system

Control lamp

Blinks or lights up

The tyre pressure of a wheel has dropped considerably compared to the pressure set by the driver.

 **Stop the vehicle!** Stop the vehicle safely as soon as possible. Avoid sudden manoeuvres and braking! Check all tyres and pressures. Replace any damaged tyres.

System fault

Consult a specialised workshop if the tyre pressure is correct and the lamp remains lit after switching the ignition off and back on again.

Several control and warning lamps light up for a few seconds when the ignition is switched on while the function is verified. They will switch off after a few seconds.

⚠ WARNING

Observe the safety warnings » ⚠ in Control and warning lamps on page 88.

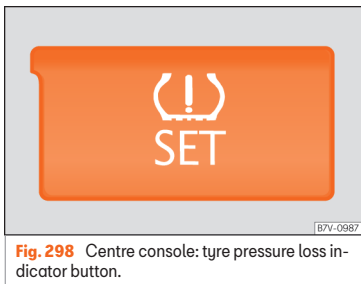
Tyre pressure monitor indicator

Fig. 298 Centre console: tyre pressure loss indicator button.

The tyre pressure monitor indicator compares wheel revolutions and, with this information, the tread of each wheel using the ABS sensors.

The tyre pressure monitor indicator warns the driver if it detects a considerable drop in tyre pressure of one or several tyres while driving. Loss of tyre pressure will be indicated by the indicator (⚠) as well as an audible warning and sometimes a text message on the instrument panel display.

Wheel tread change

The wheel diameter changes when:

- Tyre pressure is changed manually.
- Tyre pressure is insufficient.
- The tyre structure is damaged.
- The vehicle is unbalanced because of a load.
- The wheels on an axle are subject to a heavier load (e.g. with a heavy load).
- The vehicle is fitted with snow chains.
- The temporary spare wheel is fitted.
- The wheel on one axle is changed.

There may be a delay in the reaction of the tyre pressure monitoring indicator (⚠) or it may not indicate anything under certain circumstances (e.g. sporty driving, snow-covered or unpaved roads, or when driving with snow chains).

Calibrate the tyre pressure monitoring indicator

After changing the tyre pressure or replacing one or more wheels, the tyre pressure monitoring indicator must be recalibrated. Do the same, for example, when the front and rear wheels are swapped.

- Switch the ignition on.
- Press and hold down the (⚠) **SET** » Fig. 298 button until an audible signal is heard.

When driving, the system self-calibrates the tyre pressure provided by the driver and the wheels fitted. After a long journey with varied speeds the programmed values are collected and monitored.

With the wheels under very heavy loads, the tyre pressure must be increased to the total recommended tyre pressure before calibration » Fig. 295.

If the tyre monitor system button is pressed down, the new tyre pressures are confirmed.

⚠ WARNING

When the tyres are inflated at different pressures or at a pressure that is too low then a tyre may be damaged resulting in a loss of control of the vehicle and a serious or fatal accident.

- If the lamp (⚠) lights up, reduce speed immediately and avoid any sudden turning or braking manoeuvre. Stop when possible, and check the tyre pressure and status.
- The tyre monitoring system can only operate correctly if all of the tyres are inflated to the correct pressure when cold.
- If a tyre has not been punctured and it does not have to be changed immediately, drive to the nearest specialised workshop at a moderate speed and have the tyre checked and inflated to the correct pressure.

»

⚠ WARNING

Incorrect use of the tyre pressure monitoring indicator set button could result in the indicator giving incorrect warnings or prevent it from indicating the danger caused by very low tyre pressure »» Fig. 298.

i Note

- Driving for the first time with new tyres at a high speed can cause them to slightly expand, which could then produce an air pressure warning.
- Do not only rely on the tyre monitoring system. Regularly check your tyres to ensure that the tyre pressure is correct and that the tyres are not damaged due to puncture, cuts, tears and impacts/dents. Remove objects from the tyres only when they have not pierced the tyres.
- The tyre pressure monitoring indicator does not function when there is a fault in the ESC or ABS »» page 288.
- An incorrect warning may be given when snow chains are in use because the chains increase the tread of the wheel.

Maintenance

SEAT Maintenance Programme

Service intervals

Service work and the Digital Maintenance Plan

Log of services performed (“Digital Maintenance Plan”)

The SEAT dealership or a specialised workshop records Service receipts in a central system. Thanks to this comprehensive documentation of the service history, it is possible to reproduce the services performed any time. SEAT recommends requesting a Service receipt after every service carried out containing all the services carried out on the system.

Whenever there is a new service the receipt is replaced with a current one.

The Digital Maintenance Plan is not available in some markets. In this case, your SEAT dealer will inform you about the current documentation of the work.

Service works

In the Digital Maintenance Plan, your SEAT authorised service or specialised workshop documents the following information:

- When each one of the services was carried out.
- Whether a specific repair has been suggested, e.g. changing the brake pads in the near future.
- If you have expressed a special request for the maintenance. Your Service Advisor will write the work order.
- The components or fluids that were changed.
- The date of the next service.

The Long Life Mobility Warranty is valid until the next inspection. This information is documented in all checks performed.

The type and the volume of the service may vary from one vehicle to another. A specialised workshop will be able to provide specific information on the jobs for your vehicle.

WARNING

If the services are insufficient or not performed and if the service intervals are not observed, the vehicle may be immobilised in traffic cause an accident and severe injuries.

- **Make sure that any repairs are carried out by a SEAT authorised service or specialised workshop.**

CAUTION

SEAT cannot be held liable for any damage to the vehicle due to insufficient work or of lack of availability of spare parts.

Note

Regular services on the vehicle not only maintain its value, but also its correct operation and road safety. For this reason, conduct the services in accordance with SEAT guidelines.

Set Service or Flexible Service Intervals

Services are classified as **oil change service** and **inspection**. The service interval display on the instrument panel display serves as a reminder of the next service.

Depending on the features, the engine and the conditions of use of the car, either the **Fixed service** or the **Flexible service** will be applied for an oil change service. »

How to know which type of service needs to his vehicle

- Check the tables below:

Oil change service ^{a)}		
PR No.	Type of service	Service interval
Q11	Fixed	Every 5000 km or after 1 year^{b)}
Q12		Every 7500 km or after 1 year^{b)}
Q13		Every 10000 km or after 1 year^{b)}
Q14		Every 15000 km or after 1 year^{b)}
Q16	Flexible	According to the service interval display

^{a)} The data are based on normal conditions of use.

^{b)} Whatever happens first.

Inspection Service^{a)}

According to the service interval display

^{a)} The data are based on normal conditions of use.

Particular characteristics of the Flexible Service

Regarding the **Flexible Service**, the oil change service only has to be performed when the vehicle needs it. To calculate when

you have to carry out this service, take into account the individual conditions of use and personal driving style. A major component of the flexible service is the use of LongLife oil instead of conventional engine oil.

Bear in mind the information about the specifications of the engine oil according to the VW standard »» page 318.

If you do not want to the flexible service you can select the fixed service. However, a fixed service may affect service costs. The Service Advisor will gladly advise you.

Service interval display

At SEAT, the dates of the services are indicated by the service interval display on the instrument panel display »» page 83.

The service interval display gives information for service dates that involve an engine oil change or an inspection. When the time for the corresponding service comes, additional work required, such as the change of brake fluid and the spark plugs, can be carried out.

Information about the terms of use

The service intervals and groups are usually based on **normal conditions of use**.

If, on the other hand, the vehicle is under **adverse conditions of use**, some of the work

must be carried out before the next service period or even between service intervals.

Conditions of use adverse include:

- The use of fuel with a high sulphur content.
- Frequent short trips.
- Letting the engine idle for a long period of time, as in the case of taxis.
- Using the vehicle in areas with thick dust.
- Frequent driving with a trailer (depending on equipment).
- Using the vehicle mostly in situations with a lot of traffic and stops (e.g. in a city).
- Using the vehicle mostly in winter.

This applies especially for the following parts (depending on equipment):

- Dust and pollen filter
- Air Care allergen filter
- Air filter
- Toothed chain
- Particulate filter
- Engine oil

The Service Advisor of your specialised workshop will gladly inform you about the need of performing service work between normal service intervals, always considering the conditions of use of your vehicle.

⚠ WARNING

If the services are insufficient or not performed and if the service intervals are not observed, the vehicle may be immobilised in traffic and cause accidents and severe injuries.

- Have the services conducted at authorised SEAT services or specialised workshops.

ⓘ CAUTION

SEAT cannot be held liable for any damage to the vehicle due to insufficient work or of lack of availability of spare parts.

Service sets

Sets of services include all the **maintenance works** needed to ensure the safety and the smooth running of the vehicle (**depending on the conditions of use and the features of the vehicle**, such as the engine, gearbox, or operating fluids). Maintenance services are divided into *inspection* and *review* services. Consult the details of the jobs required for your vehicle at:

- Your SEAT authorised service
- Your specialised workshop

Due to technical reasons (continuous development of components) the sets of services

may vary. Your SEAT authorised service or specialised workshop is always receiving updates in time.

Additional service offers**Approved spare parts**

Original SEAT Spare Parts have been conceived for their vehicles and approved by SEAT S.A., with a special emphasis on safety. These parts correspond exactly to the manufacturer's requirements in terms of design, accuracy of the measurements and materials. The original SEAT Spare Parts have been conceived exclusively for your vehicle. For this reason, we always recommend the use of Original SEAT Spare Parts. SEAT S.A. cannot be held liable for the safety and suitability of parts from other manufacturers.

Approved spare parts

Approved spare parts, following the manufacturer's requirements, are an additional service to you, offering the possibility of replacing complete sets, such as: light engine, gearboxes, heads, control units, electrical components, etc.

These parts are, **approved parts**, and are the same as the factory parts, which are also approved spare parts.

Original accessories

We recommend you only use SEAT Original Accessories and SEAT approved accessories for your vehicle. The reliability, safety and suitability of these accessories have been inspected specifically for this type of vehicle. SEAT cannot be held liable for the safety and suitability of parts from other manufacturers.

SEAT Service Mobility

Since the moment you purchase your SEAT vehicle you will be able to enjoy the benefits and coverage of the SEAT Mobility Service.

For the first two years after the purchase, your new SEAT vehicle is automatically covered by the SEAT Mobility Service without additional costs.

If you wish to enjoy this service after this period, you can extend SEAT Mobility as long as you carry out the recommended Inspection and Maintenance Services at a SEAT Authorised Service. »

If your SEAT vehicle is immobilised due to a fault or an accident, our assistance services will help you keep moving.

Take into account that the SEAT Mobility Service differs depending on the country in which the vehicle was purchased. For further information ask your SEAT dealership or the SEAT website in your country.

Warranty

Fault-free operation warranty

SEAT Authorised Services ensure the perfect condition of new vehicles. Check the purchase agreement or complementary additional documentation provided by your Technical Service to see the conditions and the terms of the warranty. Consult further information in this regard in your SEAT Official Service.

Vehicle maintenance

Maintenance and cleaning

Basic observations

Regular and careful care helps to maintain the value of your vehicle. In addition, it may become a prerequisite to demand the warranty in the event of corrosion damage and deficiencies in the paint coat of the body-work.

Specialised workshops have the necessary care products. Please follow the instructions for application on the packaging.

WARNING

- **Cleaning products and other materials used for car care can be damaging to your health if misused.**
- **Always keep care products in a safe place, out of the reach of children. Danger of poisoning!**

For the sake of the environment

- **When purchasing car care products, chose products that are compatible with the environment.**
- **The waste from car-care products should not be disposed of with ordinary household waste.**

Washing the vehicle

The longer you take to clean the tanks, e.g. remains of insects, bird excrements, tree resin or anti frost salt adhered to your vehicle, the more damage it can cause to the surface. High temperatures, for instance strong sunlight, further intensify the damage.

Before washing the car, soften the dirt using plenty of water.

To remove encrusted dirt such as insects, bird droppings or tree resin, use a lot of water and a microfibre cloth.

Have the underside of the vehicle washed after the end of the anti frost salts in winter.

High pressure cleaning equipment

When washing the vehicle with a high-pressure cleaner, always follow the operating instructions for the equipment. This applies particularly to the operating pressure and the distance between the spraying water. Do not aim the jet directly to the side window gaskets, doors, covers or the panoramic sunroof; the same applies to tyres, rubber hoses, soundproofing material, sensors or camera lenses. Keep a distance of at least 40 cm.

Do not remove snow and ice with a high-pressure cleaner.

Do not use a nozzle that sprays the water out in a direct stream or one that has a rotating jet for forcing off dirt.

The water temperature must not exceed 60°C.

Automatic car washes

Spray the vehicle before starting the car wash.

Make sure that the windows and the panoramic sunroof are closed and the windscreen wipers are deactivated. Bear in mind the instructions of the car wash tunnel operator, especially if your vehicle has detachable parts.

Use of car washes without brushes if possible.

Washing by hand

Clean your vehicle from top to bottom with a soft sponge or with a brush. Only use cleaning products that do not contain solvents.

Washing vehicles with a matte paint by hand

To prevent damage to the vehicle when washing it, first remove the thicker dust and dirt. To remove traces of insects, grease and fingerprints, it is best to use a special cleaner for matte paint.

Apply the product with a microfibre cloth. To avoid damaging the surface of the paint, do not apply too much pressure.

Rinse with plenty of water. Then clean it with a neutral cleaning product and a soft microfibre cloth.

Rinse the vehicle again with plenty of water and then leave it to dry. Remove traces of water with a leather cloth.

WARNING

- Only wash the vehicle with the ignition switched off or according to the specifications of the car wash tunnel operator. Risk of accident!
- When cleaning the underbody or the inside of the wheel arches, protect yourself from sharp or pointy metal parts. Risk of cut!
- After cleaning the brakes could act more slowly due to moisture or, in winter, the ice on the brake discs and pads. Risk of accident! In this case the brakes should be dried by pressing the brake pedal several times.

CAUTION

- Before washing the vehicle in an automatic car wash, please make sure to retract the exterior mirrors to prevent them from being damaged. The electric folding

exterior mirrors should only be folded electronically!

- Do not wash the vehicle in direct sunlight. Risk of damaging the paint job!
- Do not use sponges, abrasive household sponges or similar to clean insect remains. Risk of damaging the surface!
- Vehicle parts with matte paint:
 - Do not use polish or hard wax. Risk of damaging the surface!
 - Never select washing programs that include the use of wax. This could damage the appearance of matte paint.
 - Do not put stickers or magnets on parts with matte paint, as removing them may damage the paint.

For the sake of the environment

The car should only be washed in special wash bays. These places are prepared to prevent oily water from getting into the public drains.

Cleaning and maintenance instructions

The cleaning and maintenance of individual components of the vehicle can be checked in the following tables. The contents should be understood merely as a recommendation. Go to your specialised workshop if you have »

special questions or parts that are not listed. Take the general considerations into account »» **△** in Take special care with... on page 345.

Cleaning the exterior

Windscreen wipers

Problem	Solution
Dirt	Soft cloth with wipers

Headlights / Tail lights

Problem	Solution
Dirt	Soft sponge with neutral soap solution ^{a1}

^{a1} Neutral soap solution: two tablespoons maximum in 1 litre of water

Sensors / Camera lenses

Problem	Solution
Dirt	<i>Sensors:</i> soft cloth with a solvent-free cleaning product <i>Camera lenses:</i> soft cloth with an alcohol-free cleaning product
Snow/ice	Hand brush/Anti frost spray with no solvents

Wheels

Problem	Solution
Antifreeze salt	Water
Brake abrasion dust	Acid-free special cleaning product

End exhausts

Problem	Solution
Antifreeze salt	Water, if a steel cleaning product is required

Covers / Trims

Problem	Solution
Dirt	Neutral soap solution ^{a1} , if a steel cleaning product is required

^{a1} Neutral soap solution: two tablespoons maximum in 1 litre of water

Paint

Problem	Solution
Paint flaws	Check the paint's colour code in an authorised service and restore with a touch-up pencil
Spilled fuel	Immediately rinse with water
Environmental rust tank	Apply rust remover and then apply hard wax. Go to your specialised workshop if you have any queries

Problem	Solution
Corrosion	Have your specialised workshop take care of this
The water does not create droplets on the clean paint	Maintain with hard wax (at least 2 times a year)
No shine despite sober maintenance/paint	Treat with suitable wax and apply paint preservative afterwards if the wax used does not contain preservative ingredients
Tanks, e.g. insect remains, bird droppings, tree sap, road salt	Immediately soften with water and remove with a microfibre cloth
Fat-based dirt, e.g. cosmetic products or sunscreen	Delete immediately with a neutral soap solution ^{a1} and a soft cloth

^{a1} Neutral soap solution: two tablespoons maximum in 1 litre of water

Carbon fibre parts

Problem	Solution
Dirt	Clean the same way as painted parts »» page 340

Decoration slides

Problem	Solution
Dirt	Soft sponge with neutral soap solution ^{a1}

^{a1} Neutral soap solution: two tablespoons maximum in 1 litre of water

Interior cleaning

Windows

Problem	Solution
Dirt	Apply windscreen cleaner and then dry with a cloth

Covers / Trims

Problem	Solution
Dirt	Neutral soap solution ^{a1}

^{a1} Neutral soap solution: two tablespoons maximum in 1 litre of water

Plastic parts

Problem	Solution
Dirt	Damp cloth
Encrusted dirt	Neutral soap solution ^{a1} , if possible solvent-free plastic cleaner

^{a1} Neutral soap solution: two tablespoons maximum in 1 litre of water

Displays/instrument panel

Problem	Solution
Dirt	Soft cloth with a liquid crystal display cleaner

Control panels

Problem	Solution
Dirt	Soft brush, then soft cloth with neutral soap solution ^{a1}

^{a1} Neutral soap solution: two tablespoons maximum in 1 litre of water

Seat belts

Problem	Solution
Dirt	Neutral soap solution ^{a1} , allowed to dry before retracting

^{a1} Neutral soap solution: two tablespoons maximum in 1 litre of water

Fabrics, artificial, Alcantara leather

Problem	Solution
Particles of dirt stuck to surfaces	Vacuum cleaner
Water-based dirt, e.g. coffee, tea, blood etc.	Absorbent cloth and neutral soap solution ^{a1}

Problem	Solution
Grease-based dirt, e.g. oil, make-up, etc.	Apply a neutral soap solution ^{a1} . Absorb the dissolved grease and paint particles drying with an absorbent cloth, in case you must treat it with water afterwards
Special dirt, e.g. pens, nail polish, dispersion paint, shoe cream etc.	Special stain remove: dry with an absorbent cloth, if applicable, apply neutral soap solution afterwards ^{a1}

^{a1} Neutral soap solution: two tablespoons maximum in 1 litre of water

Natural leather

Problem	Solution
Recent dirt	Cotton cloth with neutral soap solution ^{a1}
Water-based dirt, e.g. coffee, tea, blood etc.	Recent stains: absorbent cloth Dry stains: stain remover suitable for leather
Grease-based dirt, e.g. oil, make-up, etc.	Recent stains: absorbent cloth and suitable stain remover for leather Dry stains: grease solvent spray
Special dirt, e.g. pens, nail polish, dispersion paint, shoe cream etc.	Stain remover suitable for leather

»

Problem	Solution
Care	Apply preservative cream regularly to protect from sunlight. Use a colour preservative if required

^{a1} Neutral soap solution: two tablespoons maximum in 1 litre of water

Carbon fibre parts

Problem	Solution
Dirt	Clean like plastic parts

Take special care with...

Headlights/tail lights

- Do not clean the headlights/tail lights with a dry cloth or sponge.
- Do not use cleaning products that contain alcohol. Risk of cracks!

Wheels

- Do not use for paint wax or other abrasive products.
- If the protective coating on the paint of the rim has been damaged due to stone impacts, scratches, etc., the damage should be repaired immediately.

Camera lenses

- Do not use hot or warm water to remove ice or snow from the camera lenses. Risk of cracking the lens!
- To clean the camera lens, never use abrasive cleaning products or products with alcohol. Risk of scratches and cracks!

Windows

- Remove snow and ice from windows and exterior mirrors with a plastic scraper only. To avoid scratches, the scraper should only be pushed in one direction and not moved to and fro.
- Never remove snow or ice from windows and rearview mirrors with warm or hot water. Risk of cracks on the windows!
- To prevent damage to the heating of the rear window, do not put stickers over the heating elements.

Covers/trims

- Do not use cleaning products or chrome based cleaning agents.

Paint

- The vehicle must be free from dirt and dust before applying wax or care products. Risk of scratches!
- Do not apply wax or care products if the vehicle is exposed to direct sunlight. Risk of damaging the paint job!

- The ambient rust deposits must not be removed through friction. Risk of damaging the paint job!
- Remove cosmetic products and sunlight immediately. Risk of damaging the paint job!

Displays/instrument panel

- The screens, the instrument panel and the trim around it must not be cleaned dry. Risk of scratches!
- Make sure that the instrument panel is switched off and cooled down before cleaning.
- Make sure that no liquid leaks between the instrument panel and the trim. Risk of damage!

Control panels

- Make sure that no liquid leaks into the control panels. Risk of damage!

Seat belts

- Do not remove the seat belts to clean them.
- Seat belts and their components must never be cleaned with chemical products, nor should they be allowed to come into contact with corrosive liquids, solvents or sharp objects. Risk of damaging the fabric!
- If you find any damage to the belt webbing, belt fittings, the belt retractor or the buckle, ask your specialised workshop to replace the belt in question.

Fabrics/artificial leather/Alcantara leather

- Do not treat artificial leather/Alcantara leather with leather cleaning products, solvents, wax polish, shoe cream, stain removers or similar products.
- If the stain is very hard to remove, take the vehicle to a specialised workshop to have it removed there. This will prevent damage.
- Do not use steam cleaners, brushes, hard sponges, etc. to clean.
- Do not turn on seat heating to dry the seats.
- Sharp objects on clothing, such as zips, rivets or belts can damage the surface.
- Open Velcro, e.g. on clothes can damage the seat upholstery. Make sure that Velcro fasteners are closed.

Natural leather

- Never use solvents, wax polish, shoe cream, spot removers or similar products on leather.
- Sharp objects on clothing, such as zips, rivets or belts can damage the surface.
- Do not use steam cleaners, brushes, hard sponges, etc. to clean.
- Do not turn on seat heating to dry the seats.
- Avoid exposing leather to direct sunlight for long periods, otherwise it may tend to lose some of its colour. If the car is left for a pro-

longed period in the bright sun, it is best to cover the leather.

WARNING

Do not use water-repellent coatings on the windscreen. In bad visibility conditions such as humid weather, darkness or when the sun is in its lowest point, visibility may be impacted. Risk of accident! Such coatings can also cause the windscreen wiper blades to make noise.

Note

- **Remains of insects can be removed much more easily with previously treated paint.**
- **Regular car care treatments can prevent deposits of ambient rust.**

Remove the vehicle from traffic

If you want to leave your vehicle stationary for a long period of time, contact a qualified workshop. They will gladly inform you about the necessary measures, such as anti-corrosion protection, Service and storage.

Also take into account instructions regarding the vehicle's battery »» page 325.

Accessories and modifications to the vehicle

Accessories, spare parts and repair work

Introduction

Always ask your dealer or specialist retailer for advice before purchasing accessories and replacement parts.

Your vehicle is designed to offer a high standard of active and passive safety. For this reason, we recommend that you ask a SEAT Official Service for advice before fitting accessories or replacement parts. Your SEAT Official Service has the latest information from the manufacturer and can recommend accessories and replacement parts which are suitable for your requirements. They can also answer any questions you might have regarding official regulations.

We recommend only using **SEAT accessories** and **genuine SEAT parts**®. SEAT has tested these parts and accessories for suitability, reliability and safety. SEAT Official Services have the necessary experience and facilities to ensure that the parts are installed correctly and professionally. »

Any **retro-fitted equipment** which has a direct effect on the vehicle and/or the way it is driven, such as a cruise control system **or electronically-controlled suspension**, must be approved for use in your vehicle and bear the **e** mark (the European Union's authorisation symbol).

If **any additional electrical devices** are fitted which do not serve to control the vehicle itself (for instance a refrigerator box, laptop or ventilator fan, etc.), they must bear the **CE** sign (manufacturer conformity declaration in the European Union).

WARNING

Accessories, for example telephone holders or cup holders, should never be fitted on the covers, or within the working range of the airbags. Otherwise, there is a danger of injury if the airbag is triggered in an accident.

Technical modifications

Unauthorised modifications to the electronic components, software, wiring or data transfer in the vehicle may cause malfunctioning.

You will appreciate that your SEAT dealership cannot be held liable for any damage caused by modifications and/or work performed incorrectly.

For this reason we recommend asking official SEAT service centres to do any necessary work using **genuine SEAT parts®**.

WARNING

Incorrectly performed modifications or other work on your vehicle can lead to malfunctions and cause accidents.

Radio telephones and office equipment

Radio transmitters (fixed installation)

Any retrofit installations of radio transmitters in the vehicle require prior approval. SEAT generally authorises in-vehicle installations of approved types of radio transmitters provided that:


- The antenna is installed correctly.
- The aerial is installed on the exterior of the vehicle (and shielded cables are used together with non-reflective aerial trimming).
- The effective transmitting power does not exceed 10 Watts at the aerial base.

A SEAT Official Service and specialised workshop will be able to inform you about options for installing and operating radio transmitters with a *higher* transmitting power.

Mobile radio transmitters

Commercial mobile telephones or radio equipment might interfere with the electronics of your vehicle and cause malfunctions. This may be due to:

- No external aerial.
- External aerial incorrectly installed.
- Transmitting power more than 10 W.

You must, therefore, do not operate portable mobile telephones or radio equipment *inside the vehicle* without a properly installed external aerial **»»** .

Please note also that the maximum range of the equipment can only be achieved with an *external* aerial.

Business equipment

Retrofit installation of business or private equipment in the vehicle is permitted, provided the equipment cannot interfere with the driver's immediate control of the vehicle and that any such equipment carries the **CE** mark. Any retrofit equipment that could influence the driver's control of the vehicle must have a type approval for your vehicle and must carry the **e** mark.

WARNING

Mobile telephones or radio equipment which is operated inside the vehicle without

a properly installed external aerial can create excessive magnetic fields that could cause a health hazard.

Note

- The posterior fitting of electric and electronic equipment in this vehicle affects its licence and could lead to the withdrawal of the vehicle registration document under certain circumstances.
- Please use the mobile telephone/radio operating instructions.

Information for the user

Information for the user

Information stored by the control units

Storage of accident data (Event Data Recorder)

Your vehicle has an event data recorder (EDR).

The EDR's function is to record data in the event of a mild or serious accident. These data are used to support the analysis of how different vehicle systems behaved.

The EDR records, over a reduced time range (normally 10 seconds or less), dynamic driving data and data from the restraint systems, such as:

- How different vehicle systems worked.
- Whether the driver and the occupants were wearing their seat belts.
- How hard the acceleration or brake pedal was pressed.
- Vehicle speed.

These data will provide a better understanding of the circumstances of the accident.

Data from the driving assist systems are also recorded. This includes data such as whether the systems were inactive or active and if such action had an impact on the vehicle's dynamic behaviour, changing its path in the aforementioned situations, accelerating or decelerating the vehicle.

Depending on vehicle equipment, this includes data from systems such as:

- Adaptive Cruise Control (ACC)
- Emergency brake assistance system (Front Assist).
- Park Pilot system

The EDR data are only recorded in specific accident situations. No data are recorded in normal driving conditions.

No audio or video data inside or around the vehicle are recorded. Under no circumstances are personal data such as name, age, or gender recorded. Nevertheless, third parties (such as criminal proceedings authorities) may relate the contents of the EDR data to other data sources and create a personal reference in the context of an accident investigation.

In order to read the EDR data it is necessary to access (if legally permitted to do so) the vehicle's OBD ("On-Board-Diagnose") interface while the vehicle is switched on.

SEAT will not have access to EDR data unless the owner (or, in "Leasing" cases, the lessee or hirer) gives their consent. There may be exceptions to this, depending on legal or contractual provisions.

Due to legal requirements in safety-related products, SEAT may use the EDR data for field research and in order to improve vehicle system quality. Any data used for the purposes of research will be treated anonymously (in other words, no reference will be made to the vehicle, their owner or the lessee/hirer).

Description and operation

Your vehicle is fitted at the factory with a series of electronic control units responsible for the engine and gearbox management. In addition, the control units supervise the performance of the exhaust gas system and the airbag systems.

Therefore, while the vehicle is being driven, these electronic control units are continuously analysing the vehicle data. In the event of faults or deviations from the theoretical values, only this data is stored. Normally, the warning lamps on the instrument panel light up in the event of faults.

This data can only be read and analysed using special equipment.

The storing of the data allows specialised workshops to detect and repair faults. Stored data may include:

- Data relating to the engine or the gearbox
- Speed
- Direction of travel
- Braking force
- Detection of seat belt

The vehicle control units never record conversations held by passengers in the vehicle.

In vehicles equipped with an emergency call function via the mobile phone or other appliances connected in the vehicle, it is possible to send the vehicle position. If the control unit records an accident with airbag activation, the system may automatically send a signal. This will depend on the network operator. Normally, transmission is only possible in areas with good coverage.

Event Data Recorder

The vehicle is **not** fitted with an event data recorder.

An event data recorder temporarily stores the vehicle information. Therefore, in the event of an accident, it is possible to obtain detailed information about how the accident occurred. For example, in vehicles with airbag systems, data relating to speed of impact, seat belt status, seat positions and airbag activa-

tion times may be stored. The volume of data depends on the manufacturer.

Event data recorders can only be mounted with authorisation from the vehicle owner and, in some countries, they are governed by local legislation.

Reprogramming of control units

On the whole, all the data required for the component management is stored in the control units. The programming of certain convenience functions, such as the turn signals, individual door opening and instructions on the display can be modified using special equipment at the workshop. If this is the case, the information and descriptions given in the Instruction Manual will not match the original functions. Therefore, SEAT recommends that any modifications be recorded in the section "Other workshop notes" in the Maintenance Programme.

The technical service centre must have a record of any modification to the programming.

Reading the vehicle's fault memory

There is a diagnostics connector in the vehicle interior for reading the vehicle fault memory. The fault memory documents errors and deviations from the theoretical values of the electronic control units.

The diagnostics connector is in the driver side footwell area, next to the lever for opening the bonnet, below a cover.

The fault memory should only be read and reset by a specialised workshop.

Other important information

Environmental compatibility

Environmental protection is a top priority in the design, choice of materials and manufacture of your new SEAT.

Constructive measures to encourage recycling

- Joints and connections designed for easy dismantling.
- Modular construction to facilitate dismantling.
- Increased use of single-grade materials.
- Plastic parts and elastomers are marked in accordance with ISO 1043, ISO 11469 and ISO 1629.

Choice of materials

- Use of recycled materials.
- Use of compatible plastics in the same part if its components are not easily separated. »

- Use of recycled materials and/or materials originating from renewable sources.
- Reduction of volatile components, including odour, in plastic materials.
- Use of CFC-free coolants.

Ban on heavy metals, with the exceptions dictated by law (Annex II of ELV Directive 2000/53/EC): cadmium, lead, mercury, hexavalent chromium.

Manufacturing methods

- Reduction of the quantity of thinner in the protective wax for cavities.
- Use of plastic film as protection during vehicle transport.
- Use of solvent-free adhesives.
- Use of CFC-free coolants in cooling systems.
- Recycling and energy recovery from residues (RDF).
- Improvement in the quality of waste water.
- Use of systems for the recovery of residual heat (thermal recovery, enthalpy wheels, etc.).
- The use of water-soluble paints.

Stickers and plates

Some parts in the engine compartment come from the factory with certificates of safety, labels or plates containing important information regarding the operation of the vehicle, for example, on the fuel tank flap, on the passenger's sun visor, on the driver door strut, or on the floor of the boot.

- Never remove these certificates of safety, labels or plates, and ensure they are kept in good condition and are legible.
- If a vehicle part, bearing a certificate of safety, label or plate, is replaced, the specialised workshop should attach the information back in the same place.

Certificate of safety

A certificate of safety on the door strut states that all the safety standards and regulations established by the national traffic authorities responsible for road safety were met at the time of manufacture. It may also give the month and year of manufacture, together with the vehicle ID number.

Warning of high voltage label

There is a label close to the bonnet lock which warns of high voltage in the vehicle's electrical system. The vehicle ignition system complies with several standards, including the Canadian standard, ICES-002.

Using the vehicle in other countries and continents

The vehicle is manufactured at the factory for use in a particular country in accordance with the national legislation in force at the time of manufacture.

If the vehicle is sold in another country or used in another country for an extended period of time, the applicable legislation of that country should be observed.

It may be necessary to fit or remove certain pieces of equipment or to deactivate certain functions. Service work may also be affected. This is particularly true if the vehicle is used in a different climate for an extended period of time.

As there are different types of frequency bands around the world, you may find that the radio or navigation system supplied at the factory does not work in another country.

ⓘ CAUTION

- **SEAT does not accept liability for any damage to the vehicle due to the use of a lower quality fuel, an inadequate service or the non-availability of genuine spare parts.**
- **SEAT does not accept liability if the vehicle does not comply in part or in full with the legal requirements of other countries or continents.**

Radio and antenna reception

The aerial of radio and navigation systems fitted at the factory may be mounted in different parts of the vehicle:

- On the inside of the rear window, next to the rear window heating,
- on the inside of the rear side windows,
- on the inside of the windscreen,
- on the roof of the vehicle.

Aerials mounted on the inside of a window can be recognised by the fine wires.

ⓘ CAUTION

Aerials on the inside of windows may be damaged if knocked or if cleaned with corrosive or acid cleaning products. Do not stick adhesive labels over the heating elements and never clean the inside of the rear window with corrosive or acid products or other similar chemical products.

ⓘ Note

There may be interference with AM station reception if electrical equipment is used close to the antenna built into the glass.

Information about SEAT repairs

⚠ WARNING

Repairs or modifications which are not performed correctly may result in damage or errors in the vehicle operation, affecting the effectiveness of the driver assist and airbag systems. This could result in serious accident.

- Have any repairs or modifications carried out at a specialised workshop.

Collection of end-of-life vehicles and scrapping

Collection of end-of-life vehicles

An extensive network of used car reception centres already exists in much of Europe. After the vehicle has been delivered, you will receive a certificate of destruction describing the environmentally friendly scrapping of the vehicle in accordance with applicable legislation.

We will collect the used vehicle free of charge, provided it complies with all national legislation.

Please see your technical service for further information about the collection and scrapping of end-of-life vehicles.

Scrapping

The relevant safety requirements must be observed when the vehicle or components of the airbag or belt tensioner systems are scrapped. These requirements are known to specialised workshops.

Recycling of electrical or electronic devices

All electrical or electronic devices (EED) that are not permanently fitted in the vehicle must be marked with the following symbol:



This symbol indicates that EED must not be discarded as home waste but through selective waste collection.

Radioelectrical equipment

Simplified declaration of conformity

Your vehicle has different radioelectrical devices. The manufacturers of these devices declare that they comply with Directive 2014/53/EU when legally required. »

The full text of the EU compliance declaration is available online at the following address:

www.seat.com/generalinfo



United Kingdom

Your vehicle has different radioelectrical devices. The manufacturers of these devices declare that they comply with the UK Radio Equipment Regulations 2017 (SI 2017/1206) if required by law.

The full text of the declaration of conformity is available online at the following Internet address:

www.seat.com/generalinfo



Ukraine

Your vehicle has different radioelectrical devices. The manufacturers of these devices declare that they comply with Ukraine Decree 355/2017 (TR Radio Equipment) where legally required.

The full text of the declaration of conformity is available online at the following Internet address:

www.seat.com/generalinfo



Addresses of the manufacturers

The address of the manufacturers of components that, due to their size or nature, cannot include a sticker are listed below, as long as it is legally required:

Central control unit (BCM)

Robert Bosch GmbH/Braunschweig
Theodor-Heuss-Strasse 12
38122 - Braunschweig, Germany
Phone: 0049 53188890

Keyless Access system

HELLA GmbH & Co. KGaA/Hamm
Roemerstr. 66
59075 - Hamm, Germany
Phone: 0049 23817980

Roof antenna

ASK Industries S.p.A
Via dell'Industria n.12/14/16
60037 Monte San Vito (AN), Italy
Phone: +3907174521
Website: www.askgroup.it

Mitsumi Electronics Europe GmbH
Siemensstrasse 32
63225 Langen, Germany
Phone: +49 (0) 6103913-0
Website: www.minebeamitsumi.co.jp

Molex CVS Hildesheim GmbH
Daimlerring 31
31135 Hildesheim, Germany
Phone: +49 3377 3160
Website: www.molex.com

Antenna amplifiers

ASK Industries S.p.A
Via dell'Industria n.12/14/16
60037 Monte San Vito (AN), Italy
Phone: +3907174521
Website: www.askgroup.it

Hirschmann Car Communication GmbH
Stuttgarter Strasse 45-51
72654 Neckartenzlingen, Germany
Phone: +49 7127 140
Website: www.te.com

KATHREIN Automotive GmbH
Römerring 1
31137 Hildesheim, Germany
Phone: +498031184-0
Website: www.kathrein.com

Molex CVS Hildesheim GmbH
Daimlerring 31
31135 Hildesheim, Germany
Phone: +49 3377 3160
Website: www.molex.com

Navigation antenna

Hirschmann Car Communication GmbH
Stuttgarter Strasse 45-51
72654 Neckartenzlingen, Germany
Phone: +49 7127 140
Website: www.te.com

KATHREIN Automotive GmbH
Römerring 1
31137 Hildesheim, Germany
Phone: +498031184-0
Website: www.kathrein.com

Connectivity Box

Molex CVS Dabendorf GmbH
Märkische Strasse 72
15806 Zossen OT Dabendorf, Germany
Phone: +49 3377 3160
Website: www.molex.com

Basic infotainment system

Panasonic Automotive Systems Czech
U Panasonicu 266
530 06, Pardubice, Czech Republic

Optional infotainment system

LG Electronics Mlawa SP
LG Electronics 7
06 500, Mlawa

Remote control key

Digades GmbH Digitales Und Ana/Zittau
Äußere Weberstr. 20
02763 - Zittau, Germany
Phone: 0049 358357750

Instrument panel

Analogue SE38x/SE316
Visteon Electronics Germany GmbH
Visteonstr. 4-10
50170 Kerpen, Germany

Analogue all other models
Continental Automotive Spain, S.A.
Crta. de Rubí a Ullastrell, nº 12-30
08191 Rubí (Barcelona - Spain)

FPK (digital)
Continental Automotive GmbH
VDO-Strasse 1,
64832 Babenhausen, Germany

Panasonic Automotive Systems Europe
GmbH
Robert Bosch Str. 27-29
63225 Langen, Germany

Panasonic Automotive Systems Czech,
s.r.o.
U Panasonicu 266
530 06, Pardubice, Czech Republic

Front radar sensors

MRR for SE38X
Robert Bosch GmbH
Markwiesenstrasse, 46
72770 Reutlingen (Kusterdingen) Germany

MRR for Tarraco, Ateca, Ibiza, Arona
Automotive Distance Control Systems
GmbH
Peter-Dornier-Strasse, 10
88131, Lindau, Germany

Rear radar sensors

Hella GmbH & Co. KGaA
Rixbecker Straße 75
59552 Lippstadt (Germany)

Online Connectivity Unit

LG ELECTRONICS INC.
10, Magokjungang 10-ro,
Gangseo-gu, Seoul, Republic of Korea

Frequency bands, station power

Radioelectrical equipment ^{a)}	Frequency band	Max. station power	Valid for models
Radiofrequency remote control (vehicle)	433.05-434.78 MHz	10 mW (ERP)	All SEAT models
	433.05-434.79 MHz	10 mW	
	868.0-868.6 MHz	25 mW	
	434.42 MHz	32 µW	
Radio frequency remote control (auxiliary heater)	868.7-869.2 MHz (869.0 MHz)	25 mW	Leon, Ateca and Tarraco
	868.0-868.6 MHz (868.3 MHz)	3.1 mW	Alhambra
Transmitted-Receiver (independent heating)	868.0-868.6 MHz (868.3 MHz)	23.5 mW	Alhambra
	868.7-869.2 MHz (869.0 MHz)	23.5 mW	Leon, Ateca and Tarraco
Bluetooth	2402-2480 MHz	6 dBm	All SEAT models
	2400-2483.5 MHz	10 dBm	
Connection to the external antenna of the car	GSM 900: 880-915 MHz	33 dBm	Leon, Alhambra and Tarraco
	GSM 1800: 1710-1785 MHz	30 dBm	
	WCDMA FDD I: 1920-1980 MHz	24 dBm	
	WCDMA FDD III: 1710-1785 MHz	21 dBm	Tarraco and Leon
	WCDMA FDD VIII: 880-915MHz	21 dBm	
	LTE FDD1: 1920-1980 MHz	23 dBm	
	LTE FDD3: 1710-1785 MHz	23 dBm	
	LTE FDD7: 2500-2570 MHz	23 dBm	
	LTE FDD8: 880-915 MHz	23 dBm	
	LTE FDD20: 832-862 MHz	23 dBm	

Information for the user

Radioelectrical equipment ^{a1}	Frequency band	Max. station power	Valid for models
Wireless hotspot	2400-2483.5 MHz	10 dBm	Leon, Ateca and Tarraco
Keyless Access	434.42 MHz	32 μ W	Ibiza, Arona, Leon, Ateca and Tarraco
Radar sensors for front assist systems	76 GHz-77 GHz	28.2 dBm	Leon and Alhambra
		35.0 dBm	Ibiza, Arona, Ateca and Tarraco
Radar sensors for rear assist systems	24050-24250 MHz	20 dBm	Ibiza, Arona, Leon, Ateca and Tarraco
Wireless charging	110-120 kHz	5 W	Ibiza, Arona, Leon, Ateca and Tarraco
Instrument panel	125 kHz	40 dB μ A/m	Ibiza, Arona, Ateca, Tarraco and Alhambra
Online Connectivity Unit	EGSM900: 880-915 MHz	33 dBm	Ibiza, Arona, Leon, Ateca and Tarraco
	DCS1800: 1710-1785 MHz	31 dBm	
	UMTS FDD 1: 1920-1980 MHz	24 dBm	
	UMTS FDD 3: 1710-1785 MHz	24 dBm	
	UMTS FDD 8: 880-915 MHz	24 dBm	
	E-UTRA FDD 1: 1920-1980 MHz	23.5 dBm	
	E-UTRA FDD 3: 1710-1785 MHz	23.0 dBm	
	E-UTRA FDD 7: 2500-2570 MHz	23.5 dBm	
	E-UTRA FDD 8: 880-915 MHz	23.0 dBm	
	E-UTRA FDD 20: 832-862 MHz	23.5 dBm	
	E-UTRA FDD 28: 703-748 MHz	23.0 dBm	

^{a1} The commissioning or authorisation of radioelectrical technology may be restricted in some European countries, forbidden or only allowed with additional requirements.

Additional information for countries outside the European Union

Mexico

Your vehicle has different radioelectrical devices. The manufacturers of these devices declare that they comply with Directive RLVCOAR15-0008 when legally required. The full text of the declaration of conformity is available online at the following Internet address:

<https://www.seat.mx/servicio/mi-seat/manual-del-propietario.html>

Certificate: RLVHERS17-0286. RS4 Hella KGaA Hueck & Co. short-range radar IFT:RLVHERS17-0286. The operation of this equipment is subject to the following two conditions: (1) this equipment or device may not cause harmful interference, and (2) this equipment or device must accept any interference, including interference that may cause undesired operation.

United Kingdom

This vehicle has various radio equipment devices installed.

The following acts as importer of the radio equipment devices for the United Kingdom market within the meaning of The Radio Equipment Regulations 2017:

Volkswagen Group United Kingdom Ltd.

Yeomans Drive, Blakelands
Milton Keynes, MK 14 5AN
United Kingdom

Türkiye

Telsiz Ekipmanları Yönetmeliği (2014/53/AB)

Aracınızda çeşitli telsiz ekipmanları bulunmaktadır.

Telsiz Ekipmanları Yönetmeliği (2014/53/AB) açısından Türkiye pazarı için radyo ekipmanı ithalatçısı (bu bilgi sadece resmi temsilcimiz olan Doğu Otomotiv Servis ve Ticaret A.Ş.'nin ithal ettiği ürünler için geçerlidir):

Doğu Otomotiv Servis ve Ticaret A.Ş.

Şekerpinar Mahallesi, Anadolu Caddesi,
No: 22 ve 45
41420 Çayırova/Kocaeli

Ukraine

Імпортёр:

ТОВ «Порше Україна»
просп. Павла Тичини, 1В, офіс „В“, 4-й
поверх
02152 Київ, Україна.

Importer:

Porsche Ukraine LLC
Pavla Tychny ave. 1V, Office "B", 4th floor
02152 Kyiv, Ukraine.

Technical data

Indications about the technical data

Important information

Introduction

The values indicated in the technical data may differ depending on optional equipment or version of the model, as well as in the case of special vehicles and equipment for certain countries.

The information in the official vehicle documentation takes precedence at all times.

Abbreviations used in the Technical Specifications section

kW	Kilowatt, engine power measurement.
PS	Pferdestärke (horsepower), formerly used to denote engine power.
rpm, 1/min	Revolutions per minute - engine speed.
Nm	Newton metres, unit of engine torque.
CZ	Cetane number, indication of the diesel combustion power.
RON	Research octane number, indication of the knock resistance of petrol.

Vehicle identification data

Vehicle ID number

The vehicle ID number can be found in the following places:

- One the vehicle's data label.
- In front, under the windscreen.
- To the right in the engine compartment.

Type plate

The type plate is located on the vehicle's right hand door frame. Vehicles for certain export countries do not have a type plate.

Fuel consumption

Approved consumption values are derived from measurements performed or supervised by certified EU laboratories, according to the legislation in force at the time (for more information, see the Publications Office of the European Union on the EUR-Lex website: © European Union, <http://eur-lex.europa.eu/>) and apply to the specified vehicle characteristics.

The values relating to fuel consumption and CO₂ emissions can be found in the documentation provided to the purchaser of the vehicle at the time of purchase.

Fuel consumption and CO₂ emissions depend on the equipment/features of each indi-

vidual vehicle, as well as on the driving style, road conditions, traffic conditions, environmental conditions, load or number of passengers.

Filling capacities

Tank level

Petrol engines	73 l, 8 l reserve
----------------	-------------------

Capacity of the windscreen washer fluid container

Versions without headlight washer system	approx. 3.5 litres
Versions with headlight washer system	approx. 6 litres

Weights

Load on the roof

The maximum authorised roof load for your vehicle is 100 kg (220 pounds).

Empty weight, total weight, axle loads

The empty weight of the vehicle with driver (75 kg) was calculated according to the (EU) 1230/2012 standard. Optional equipment can increase the empty weight, which means that »

the possible useful load decreases proportionally.

Trailer weight

The maximum permitted drawbar load on the ball head of the towing bracket is **100 kg**.

WARNING

**The values indicated for the maximum permitted weights must not be exceeded.
There is a risk of accident and damage!**

Engine specifications

Petrol engines	1.4 TSI Start-Stop	
Power output in kW (PS) at 1/min	110 (150)/5,000-6,000	
Maximum torque (Nm at 1/min)	250/1,500-3,500	
No. of cylinders/displacement (cm ³)	4/1,395	
Fuel	Super 95 / Normal 91 (with a slight power loss) ROZ	
Gearbox	manual	DSG
Top speed (km/h)	200 (VI)	198 (VI)
Acceleration from 0-100 km/h (seconds)	9.9	9.9
Maximum authorized weight (kg) (5/7 seats)	2,330/2,450	2,350/2,480

Dimensions.

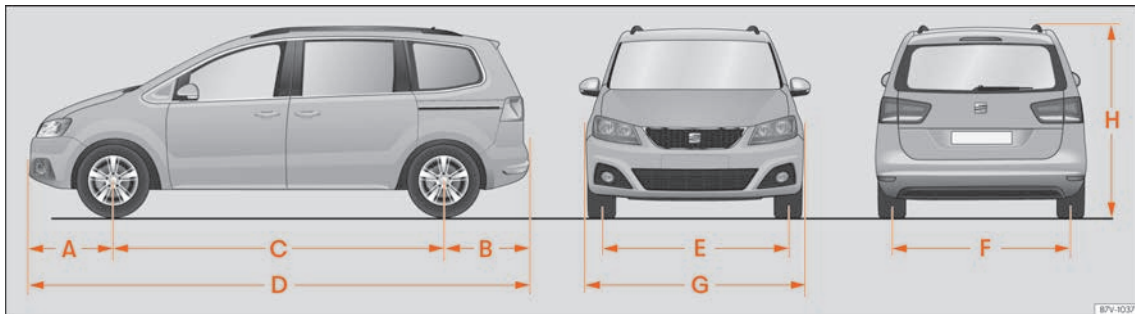


Fig. 299 Dimensions.

		ALHAMBRA
A/B	Front and rear projection (mm)	967/966
C	Wheelbase (mm)	2,921
D	Length (mm)	4,854
E/F	Front/rear ^{a)} track width (mm)	1,571/1,617
G	Width (mm)	1,904
H	Height at kerb weight (mm)	1,734 ^{b)}
	Turning radius (m)	11.9

^{a)} This data will change depending on the type of wheel rim.

^{b)} Dimension to the roof bars.

Index

Numbers and Symbols

12-volt battery

assisted start	51
automatic disconnection of devices	327
charging	327
disconnect and connect	84, 325
positive pole for jump start	52
replacement	327
winter operations	325

4Drive	256
--------------	-----

A

ABS

see Anti-lock brake system	288
----------------------------------	-----

ACC	268
-----------	-----

Access aid for the third row of seats	137
---------------------------------------------	-----

Accessories	345
-------------------	-----

Active cylinder management (ACT)

status indication	71
-------------------------	----

Adaptive Cruise Control	268
-------------------------------	-----

control and warning lamp	269
--------------------------------	-----

malfunction	268
-------------------	-----

operating	270
-----------------	-----

special driving situations	272
----------------------------------	-----

status display	269
----------------------	-----

temporarily deactivating	272
--------------------------------	-----

Additional heating

automatic disconnection	81
-------------------------------	----

see also Auxiliary heating	168
----------------------------------	-----

Adjust

fold down the front passenger's backrest ..	138
---------------------------------------------	-----

front seats	131
-------------------	-----

headrest	134
----------------	-----

lights	123
--------------	-----

seats	12
-------------	----

seat with memory	136
------------------------	-----

time	80
------------	----

Adjusting the seat belt	19
-------------------------------	----

AFS	121
-----------	-----

Airbags	22
---------------	----

description	23
-------------------	----

Airbag system	22
---------------------	----

activation	24
------------------	----

control lamp	24
--------------------	----

deactivation of the front airbag	26
----------------------------------------	----

description	23
-------------------	----

front airbags	24
---------------------	----

how it works	24
--------------------	----

Air conditioning

Climatronic	162
-------------------	-----

manual air conditioning	164
-------------------------------	-----

usage instructions	165
--------------------------	-----

Air recirculation	166
-------------------------	-----

Air vents	166
-----------------	-----

Alternator

warning lamp	326
--------------------	-----

AM	194
----------	-----

Android Auto™

activate	190
----------------	-----

establish connection	190
----------------------------	-----

main menu	190
-----------------	-----

requirements	190
--------------------	-----

Antenna	351
---------------	-----

Anti-lock brake system	288
------------------------------	-----

Anti-puncture	42, 43
---------------------	--------

Anti-puncture kit	41, 42
-------------------------	--------

check after 10 minutes	44
------------------------------	----

components	43
------------------	----

inflating the tyre	43
--------------------------	----

sealing the tyre	43
------------------------	----

Anti-puncture set	42
-------------------------	----

Anti-theft alarm system	101
-------------------------------	-----

trailer	304
---------------	-----

Anti-trap function

electric sliding doors	107
------------------------------	-----

sunroof	116
---------------	-----

sunshade blind (glass roof)	116
-----------------------------------	-----

windows	114
---------------	-----

Antifreeze	321
------------------	-----

Apple CarPlay	189
---------------------	-----

Aspects to think about before starting the vehicle	11
----------------------------------------------------------	----

ASR

connection and disconnection	289
------------------------------------	-----

see Brake assist systems	289
--------------------------------	-----

see also Traction control system	288
----------------------------------------	-----

Assistance call	91
-----------------------	----

Assistance systems

ACC	268
-----------	-----

adaptive cruise control	268
-------------------------------	-----

anti-slip regulation during acceleration (ASR)	289
------------------------------------------------------	-----

Auto Hold function	286
--------------------------	-----

blind spot detector (BSD) with parking assistant (RCTA)	277
---------------------------------------------------------------	-----

connecting	86
------------------	----

cornering lights	121
------------------------	-----

cruise control	262
----------------------	-----

disconnecting	86
---------------------	----

- driver alert system 77
 dynamic chassis control (DCC) 255
 ear View Camera 297
 emergency braking (Front Assist) 265
 front camera 261
 front radar 260
 general notes 259
 optical parking system 296
 park Assist 290
 parking aid 295
 parking distance warning 295
 rear cross traffic alert (RCTA) 277
 reverse assist 297
 road sign detection system messages 78
 safety advice 259
 steering wheel assist for parking 290
 system limits 259
 Tyre pressure monitor indicator 335
 Tyre pressure monitoring 334
 Assisted start 51
 Audible warning
 control and warning lamps 87
 lights 117
 unbuckled seat belt 15
 Auto Hold 286
 Auto Hold Function 286
 Auto Lock (central locking) 95
 Automatic car wash 341
 disconnecting the Auto Hold function 286
 Automatic dipped beam headlight control ... 118
 Automatic gearbox 248
 control lamp 248
 driving tips 250
 emergency release of the selector lever... 252
 ignition key extraction lock 241
 kick-down 251
 launch-control program 252
 operating fault 251
 selector lever lock 249
 selector lever positions 248
 steering wheel with shift paddles 250
 tiptronic 248, 250
 towing 55
 AUX-IN 239
 external audio source 212
 AUX-IN multimedia socket 152
 Auxiliary heating 168
 activate 170
 automatic disconnection 81
 connecting 168
 disconnecting 168
 electricity consumers 171
 programming 170
 radio-operated remote control 169
 remote control range 169
 special characteristics 168, 171
 usage instructions 170
B
 Background lighting 124
 Bag hooks 148
 Battery 94
 change on the remote control (independent heating) 169
 Before starting the vehicle 11
 Belt tightening 21
 Bicycle carrier
 fitting onto the coverable tow hook 309
 max. load rating 309
 Blind spot detector (BSD) 277, 278
 control lamps 278
 driving situations 280
 how it works 278
 indication on the exterior mirror 279
 malfunction 277
 trailer 282
 Blown bulbs
 change a bulb 60
 Bluetooth®
 connect audio source 212
 Bonnet 315, 317
 opening and closing 316
 Brake fluid 323
 Brakes 283
 brake fluid 323
 brake servo 283
 braking assistant 288
 electronic parking brake 285
 emergency brake function 285
 new brake pads 283
 Braking assistant 288
 Braking system
 warning lamp 282
 BSD
 see blind spot detector (BSD) 277
 BSD Plus 276
C
 Camera
 cleaning 79
 Lane Assist 274
 Capacities
 window washer water 324
 Card compartment 155

- Care
 - see Cleaning the vehicle 340
- Catalytic converter 314
- CD Changer 152, 157
- Central armrests 139
- Central locking 95
 - anti-theft alarm 101
 - central locking switch 97
 - emergency lock 105
 - Keyless Access 98
 - remote control key 97
 - selective unlocking system 97
- Change a bulb 60
 - bodywork 64
 - front bumper 63
 - halogen headlights 61
 - number plate light 66
 - rear lid 64
 - tail lights 64
 - xenon headlight 62
- Change the wiper blades 50
- Changing a wheel 45
 - subsequent work 49
 - wheel nuts 46
- Changing parts 345
- Checking levels
 - engine compartment 317
- Childproof locks
 - electric windows 113
- Child seat
 - integrated child seat 36
- Child seats
 - group classification 30
 - ISOFIX system 33
 - safety instructions 31
- securing with the seat belt 35
 - Top Tether system 33, 35
- Cleaning the vehicle
 - high pressure cleaning equipment 340
 - special care 344
 - vehicle exterior 342
 - vehicle interior 343
 - wash the vehicle 340
- Climate control
 - auxiliary heating 168
 - rear seats 165
- Climatronic 162
- Clocks
 - set the time 80
- Closing 95
 - bonnet 316
 - luggage compartment 109
 - panoramic roof 115
 - windows 113
- Coat hooks 157
- Coming Home 122
- Communication between the Infotainment
 - System and mobile devices 186
- Compass 83
- Connectivity
 - Full Link 186
- Connectors
 - faults 160
- Contact 241
- Control and warning lamps 87
 - adaptive cruise control 269
 - airbags 26
 - airbag system 24
 - alternator 326
 - anti-lock brake system ABS 287
- ASR 287
 - audible warning 87
 - blind spot detector (BSD) 278
 - braking system 282
 - cruise control (GRA) 262
 - door 104
 - EDL 287
 - electromechanical steering 254
 - electronic parking brake 282
 - emissions control 314
 - engine coolant 82
 - engine management 314
 - engine oil 319
 - ESC 287
 - fuel reserve 81
 - Lane Assist 274
 - lights 117
 - particulate filter 314
 - press on the brake 265, 269
 - rear cross traffic alert (RCTA) 278
 - rear lid 108
 - refuelling 81, 311
 - remote control (independent heating) 169
 - replacement 248
 - seat belt 15
 - Start-Stop 245
 - steering column lock 254
 - tow hook 308
 - Tyre pressure monitor system 334
 - windscreen washer fluid level 125
- Controls and displays
 - overview 69
- Controls on the steering wheel 89
- Control units 348
 - reprogramming 349

- Convenience close function
windows 113
- Convenience functions
reprogramming 349
- Convenience open function
windows 113
- Convenience phone system
outside antenna 239
USB port 239
- Cooling system
check the coolant 322
refilling coolant 322
- Copyright 203
information 180
- Cornering lights
dynamic 121
static 121
- Correct sitting position 12
driver 12
- Cruise control 262
control and warning lamp 262
operation 264
- D**
- DAB 194
see: RADIO 196
- Dangers of not using the seat belt 17
- Data bank view
see MEDIA 209
- Data label 357
- Data logger 348
- DCC
see Adaptive suspension 255
- Deactivation of cylinders
see Active cylinder management (ACT) 71
- Deactivation of the front airbag 26
- Delayed shutdown (Infotainment system) 177
- Detection of road signs
disconnecting 79
switching on 79
trailer 79
- Diagnostic connector 349
- Disconnection of devices 327
- Disposal
airbag system 351
seat belt tensioners 22
vehicle at the end of its useful life 351
- Distance control
see Adaptive Cruise Control 268
- Door
child lock 107
warning lamp 104
- Door cylinder 104
- Door emergency lock 105
- Door handle 104
- Door lock 104
- Doors 103
- Drawers 156
- Drink holder
bottle holder 157
rear 158
- Driver
see Correct sitting position 12
- Driver alert system 77
- Driving
data storage 348
driving on flooded roads 258
economical 257
parking on inclines 290
park on upward slopes 290
- safe 11
trips abroad 258
with trailer 306
- Driving data 73
- Driving data indicator 73
- Driving on flooded roads 258
- DSG 248
- Duplicate keys 93
- Dust and pollen filter 161
- DVD 209
- Dynamic chassis control (DCC) 255
how it works 255
malfunction 255
operation 255
- Dynamic headlight range control 123
- E**
- E10
see Ethanol (fuel) 313
- Easy Open 98
special characteristics 111
- EDL
see Electronic differential lock 288
- Electric
windows 113
- Electric child lock 107
- Electric devices 158, 159
- Electric sliding door
anti-trap function 107
opening and closing 106
- Electric windows 113
- Electrolyte 326
- Electromechanical steering 253
lamp 253
- Electronic differential lock 288

- Electronic engine torque management (XDS) 288
- Electronic immobilizer 104, 244
- Electronic parking brake 285
 - lamp 282
- Electronic self-locking 288
- Electronic Stability Control (ESC) 288
- Emergencies
 - anti-puncture kit 42
 - changing a wheel 45
 - changing the battery 327
 - emergency vehicle towing 55
 - fire extinguishers 40
 - first aid kit 40
 - hazard warning lights 122
 - jump leads 51
 - replace a blown fuse 59
 - vehicle tool kit 41
 - warning triangle 40
- Emergency brake function 285
- Emergency braking assist system 260
 - malfunction 265
 - operation 266
 - status display 265
 - system limitations 267
 - temporarily deactivating 267
- Emergency braking warning 123
- Emergency closing and opening
 - front passenger door 105
- Emergency opening
 - driver's door 104
 - rear lid 112
- Emergency operation
 - gear selector lever 252
- Emissions control system
 - catalytic converter 314
 - control lamp 314
 - particulate filter 314
- Engine
 - assisted start 51
 - noises 242
 - preheating 241
 - running in 255
 - Start-Stop system 245
 - starting 241
- Engine and ignition
 - 12 volt power sockets 158
 - automatic ignition disconnection 242
 - emergency start 244
 - preheat the engine 242
 - starting the engine 242
 - starting the engine with Press & Drive 242
 - switching off the engine 243
- Engine compartment 315, 317
 - battery 325
 - brake fluid 323
 - coolant 321, 322
 - engine oil 320
 - opening and closing 316
 - safety instructions 315
 - window washer tank 324
- Engine coolant 321
 - check the level 322
 - control lamp 82
 - G12evo 321
 - G12 plus-plus 321
 - G13 321
- specifications 321
- temperature indicator 82
- warning lamp 82
- Engine failure
 - control lamp 314
- Engine management 314
 - control lamp 314
- Engine oil
 - change 318, 321
 - checking the oil level 320
 - consumption 320
 - dipstick 320
 - inspection service 318
 - maintenance frequencies 318
 - refill 320
 - specifications 318
- Engine oil pressure
 - control lamp 319
- Engine specifications 359
- Environment
 - ecological driving 257
 - environmental compatibility 349
 - refuelling 311
- Environmental tip
 - refuelling 311
- Equipment 345
- ESC
 - electronic stability control (ESC) 288
- Ethanol (fuel) 313
- Event data recorder 349
- Event Data Recorder 348, 349
- Exhaust gases 314
- Exterior lighting
 - change a bulb 60

- Exterior mirrors
 driving with a trailer 303
 folding 129
 heated 129
 settings 129
 Exterior view 7, 8
 External antenna 346
 Extinguisher 40
- F**
- Fabrics: clean 343
 Factors that have a negative influence on
 safe driving 11
 Fastening rings 145
 Fault
 park assist system 290
 parking aid 295
 reverse assist 298
 Fault memory
 connector 349
 reading 349
 Filling capacities
 fuel tank 357
 window washer tank 357
 Filling the tank 311
 First aid kit
 housing 40
 FM 194
 Folding chocks 41
 Folding table 155
 Folding the rear seats
 load surface 143
- Four-wheel drive 256
 snow chains 256
 towing 55
 winter tyres 256
 Frequency band
 AM 194
 change 194
 DAB 194
 FM 194
 Front airbags 24
 Front Assist
 see Emergency braking assist system 265
 Front drink holders 158
 Front passenger front airbag
 control lamp 24
 Fuel
 ethanol 313
 fuel gauge 81
 identification 312
 petrol 312
 refuelling 311
 saving 257
 Fuel consumption
 inertia disconnection 257
 why does consumption increase? 314
 Fuel gauge
 control lamp 81
 Fuel tank cap
 opening and closing 311
 Fuel tank flap
 opening and closing 311
 Full-LED headlights 60
 Full Link 186
 main menu 189
 settings 192
 Full Link™
 settings 192
 Function buttons 178
 map representation, navigation 222
 MirrorLink™ 191
 Fuses 58
 colour coded 58
 fuse box 58, 59
 preparations for replacing fuses 59
 recognise blown fuses 60
 replace 59
- G**
- GALA (speed-dependent volume) 181
 Gear-change recommendation 253
 Gearbox DSG
 see Automatic gearbox 248
 Gear change
 engage the gears (manual change) 247
 manual gearbox 247
 Gear indication 253
 Glasses case 154
 Glove compartment 153
- H**
- Handbrake
 see Electronic parking brake 285
 Hazard warning lights 122
 Head-on collisions and the laws of physics ... 17
 Head-protection airbags
 safety instructions 29

- Headlights
 change a bulb 60
 headlight washer 126
 trips abroad 124
- Headrest 133, 134
- Heating and fresh air 164
- Horn 69
- I**
- Identification of fuels 312
- Ignition 241
- Ignition key extraction lock 241
- Ignition lock 241
- Information call 91
- Infotainment buttons 177
- Infotainment System 172
 automatic playback (SCAN) 200
 AUX-IN 212
 Bluetooth® audio 212
 Bluetooth® settings 238
 CD or DVD player 209
 change the volume 177
 checkboxes 178
 factory settings 180
 FM, AM, DAB settings) 201
 function buttons 178
 general instructions for use 177
 image settings 214
 images main menu 213
 infotainment buttons 177
 input window 179
 Media settings 214
 memory card 210
 mute 177
 navigation 215
 navigation settings 224
 on-screen keyboard 179
 overview of the unit 174, 175
 phone settings 237
 preset buttons 197
 Radio mode 194
 road signs indication 224
 rotary/push buttons 177
 safety instructions 172
 scroll button 179
 scroll (screen) 179
 search on lists 179
 selecting, tuning and saving stations 198
 sound distribution [Balance and Fader] 181
 station logos 197
 switching on and off 177
 system settings 180
 Telephone mode 226
 text entry 179
 touch screen 178
 traffic information 200
 updating navigation data 215
 USB 211
 user profile settings 238
 volume and sound settings 181
 wait time 177
- Inspection 318, 337
- Inspection service 318
- Instrument panel 70, 71
 control and warning lamps 87
 display 71
 menu structure 73
 service intervals display 83
 status display 71, 73
 use with the multifunction steering wheel ... 85
 use with the wiper lever 86
- Instrument panel display 71
- Instrument panel lighting 124
- Integrated child seat 36
 fitting 37
 removing 39
 seat belt route 38
- Interferences caused by mobile phones 177
- Interior door handle 69
- Interior mirror
 anti-dazzle 128
- Interior monitoring and the anti-tow system
 activation 102
- Interior view 10
- Interlock button 249
- ISOFIX 33, 34
- ISOFIX system 33, 34
- J**
- Jack 41
 position points 47
- Jump leads 51
- Jump start 51
 description 52
 positive pole 52
- K**
- Keyless Access
 Easy Open 98
 Keyless Entry 98
 Keyless Exit 98
 Press & Drive 241
 special characteristics 100

- starting the engine 242
 - unlocking and locking the vehicle 98
 - Keyless Access lock and ignition system:
 - see Keyless Access 98
 - Keyless Entry
 - see Keyless Access 98
 - Keyless Exit
 - see Keyless Access 98
 - Keys
 - assign a key 93
 - changing the battery 94
 - remote control 93
 - spare key 93
 - synchronise 95
 - unlock and lock 97, 104
 - vehicle key 93
 - Key switch 26
 - Kick-down
 - automatic gearbox 251
- L**
- Lane Assist 274
 - control and warning lamp 274
 - Lane Assist system
 - see Lane Assist 274
 - Launch-control (automatic transmission) 252
 - Leather: clean 343
 - Leaving Home 122
 - Levels control 357
 - Lift the vehicle 47
 - Light Assist 120
 - Light range control 123
 - Lights 117
 - audible warnings 117
 - AUTO 118
 - change a bulb 60
 - coming home 122
 - control and warning lamps 117
 - control lighting 124
 - controlling the lights 117
 - cornering lights 121
 - daylight 118
 - dipped beam headlights 117
 - fog light 119
 - headlight range control 123
 - instrument lighting 124
 - interior lights 124
 - leaving home 122
 - main beam assist 120
 - main beam headlight lever 119
 - main beam headlights 117
 - reading lights 124
 - side lights 117
 - switch 117
 - switching on and off 117
 - trips abroad 124
 - turn signal lever 119
- Loading the luggage compartment
- fastening rings 145
 - general advice 140
 - luggage compartment 109, 140
 - positioning the load 140
 - positioning the luggage 140
 - rail system with fasteners 145
 - roof carrier system 151
 - trailer 305
- Load on the roof 151
- technical data 151
- Lock and unlock
- in the locking cylinder 104
 - luggage compartment 109
 - with Keyless Access 98
 - with the central locking switch 97
 - Luggage compartment 109, 140
 - closing 109
 - electric lock 110
 - electric opening 110
 - emergency unlocking 112
 - enlarge 143
 - folding the rear seats down as a cargo surface 143
 - luggage compartment lighting 124
 - net 148
 - net partition 149
 - opening and closing controlled by sensors [Easy Open] 111
 - rail system with fasteners 145
 - tray 141
 - unfolding and folding the net partition 149
 - Luggage compartment net bag 148
 - Lumbar massage 135
 - Lumbar support 131
- M**
- Main beam assist 120
 - Main beam headlight lever 119
 - Main menu
 - Android Auto™ 190
 - Full Link 189
 - MirrorLink™ 191
 - Maintenance
 - see Service 337
 - Maintenance frequencies 318

- Malfunction
 - adaptive cruise control 268
 - dynamic chassis control (DCC) 255
 - emergency brake assistance system (Front Assist) 265
 - sunroof 114
 - towing device 303
 - Manual gearbox 247
 - towing 55
 - Map display
 - function buttons 222
 - Mats 15
 - Media
 - changing track 207
 - copyright 203
 - indications and symbols 207
 - main menu 206
 - playback modes 206
 - playback order 205
 - requirements for data media 204
 - select track 208
 - switching the Media source 207
 - unreadable CD or DVD 209
 - MEDIA
 - data bank view 209
 - settings 214
 - Memory card 210
 - Memory function 136
 - MFD
 - see Multifunction display 73
 - MirrorLink™
 - activate 191
 - establish connection 191
 - function buttons 191
 - indications and symbols 191
 - main menu 191
 - requirements 191
 - Mirrors
 - adjusting the exterior mirrors 129
 - anti-dazzle interior 128
 - see also Mirrors 128
 - Mobile 346
 - Mobile phone 91
 - Mobile phones 346
 - Multifunction display 73
 - Multifunction steering wheel
 - with voice control 89
 - Multimedia 239
- N**
- Navigation 215
 - change view 221
 - entering the destination 216
 - import vCards 223
 - indications and symbols 216
 - main menu 216
 - my destinations 218
 - my route 219
 - navigation with images 224
 - points of interest 217
 - road signs indication 224
 - route 218
 - selecting the destination on the map 217
 - settings 224
 - special destinations (POI) 220
 - split screen 221
 - traffic bulletins (TRAFFIC) 222
 - NAV (navigation)
 - map display 222
 - Net
 - luggage compartment 148
 - Net partition 149
 - unfolding and folding 149
 - Noise
 - adaptive cruise control 268
 - auxiliary heating 171
 - brakes 283
 - ESC 288
 - parking brake 285
 - tyres 329, 333
 - Number of seats 13
- O**
- Octane (petrol) 312
 - Odometer 71
 - partial 72
 - total 72
 - Oil change 321
 - One-touch signalling function 119
 - Opening 95
 - bonnet 316
 - panoramic roof 115
 - tank cap 311
 - windows 113
 - Opening and closing 95
 - bonnet 316
 - by remote control 97
 - doors 103
 - electric sliding door 106
 - in the locking cylinder 104
 - panoramic roof 115
 - rear lid 109
 - sliding door 105
 - tank cap 311

- windows 113
 - with the central locking switch 97
 - Operating fault
 - automatic gearbox 251
 - Operation in winter
 - battery 325
 - headlight washer 126
 - heated windscreen washer jets 126
 - salt on the roads 127
 - snow chains 334
 - tyres 333
 - Optical parking system 296
 - Original accessories 339
 - Original SEAT Spare Parts 339
 - Overseas
 - longer stay with the vehicle 350
 - selling the vehicle 350
 - Overview (left hand drive) 9
- P**
- Painting the vehicle
 - care 342
 - Panoramic roof 115
 - Panoramic sliding sunroof
 - see Sunroof 114
 - Park Assist 290
 - Park assist system 290
 - automatic interruption 294
 - connecting or disconnecting (leaving parking space) 293
 - connecting or disconnecting (parking) 292
 - fault 290
 - interruption 292
 - leaving a parking space 293
 - parking 292
 - parking preparations 292
 - Parking 290
 - Parking aid 294, 295
 - fault 295
 - optical parking system 296
 - sensors and camera: clean 342
 - with trailer 295
 - Parking assistance 290
 - Parking brake
 - automatic disconnection 285
 - connecting 285
 - disconnecting 285
 - emergency brake function 285
 - Parking distance warning system
 - see Parking aid 294
 - Parking side lights 295
 - Parking (automatic transmission) 250
 - Particulate filter 314
 - Pedals 13, 15
 - Petrol
 - additives 312
 - particulate filter 314
 - refuelling 312
 - Phone management
 - three button module 91
 - Portable rubbish bin 156
 - Power socket 158
 - 12 Volts 159
 - faults 160
 - Power sockets
 - trailer 304
 - Power steering
 - see Electromechanical steering 253
 - Pre-installation for basic mobile phone 228
 - possible connection types 228
 - Preheating 241
 - Preheating system
 - control lamp 314
 - Preheat the engine 242
 - Press & Drive
 - start button 241
 - starting the engine 242

R

 - Radar sensors 260
 - Radio
 - frequency change 194
 - indications and icons 194
 - main menu 194
 - preset buttons 197
 - save station logos 197
 - RADIO
 - additional DAB services 196
 - additional DAB stations 196
 - automatic playback (SCAN) 200
 - DAB memories 196
 - DAB operation 196
 - DAB radio text 196
 - DAB slideshow 196
 - DAB station information 196
 - DAB transmission standards 196
 - indication of station names 195
 - radio text (RDS) 195
 - RDS 195
 - save and delete station logos 197
 - selecting, tuning and saving stations 198
 - set a station name 200
 - settings 201

- station tracking by RDS 195
 - tracking of DAB stations on FM 196
 - traffic information (TP) 200
 - Radio-operated remote control
 - see Keys 93
 - Radio reception
 - antenna 351
 - malfunctions 351
 - Radio screen: clean 343
 - Radio telephones 346
 - Radio text (RDS) 195
 - Rail system with fasteners 145
 - net to cover the luggage 146
 - Rain sensor 127
 - function control 127
 - Raise the vehicle 47
 - RCTA 281
 - see Rear cross traffic alert (RCTA) 277
 - RDS 195
 - automatic station tracking 195
 - RDS Regional 195
 - Rear cross traffic alert (RCTA) 277, 281
 - control lamp 278
 - Rear fog light
 - control lamp 117
 - Rear lid 109, 112
 - warning lamp 108
 - Rear mounting
 - towing device 310
 - Rear Traffic Alert 281
 - Rear View Camera 297
 - Rear window wiper 125
 - Recognition of road signs 224
 - Recycling 351
 - Reflective vest 40
 - Refuelling
 - control lamp 81
 - fuel gauge 81
 - opening the fuel tank flap 311
 - Releasing the seat belt 18
 - Remote control key
 - unlock and lock 97
 - Remote control (independent heating) 169
 - changing the battery 169
 - Repairs 351
 - Repair work 345
 - Reprogramming of control units 349
 - Reverse assist 297
 - display 298
 - fault 298
 - mode 1 299
 - mode 2 300
 - special characteristics 299
 - usage instructions 298
 - Reverse (automatic gearbox) 248
 - Reversing camera 297
 - Revolution counter 71, 80
 - Road signs detection system
 - how it works 78
 - limited operation 79
 - windscreen damage 79
 - Roof carrier 150
 - fix the crossbars 151
 - Roof carrier system 150
 - Roof rack 150
 - Rotary/push knobs 177
 - Rotation direction
 - tyres 49
 - Running in
 - new brake pads 283
 - new engine 255
 - new tyres 328
- ## S
- Safe 244
 - Safe driving 11
 - Safe security system 101
 - Safety
 - child safety 30
 - child seats 30
 - safe driving 11
 - Safety equipment 11
 - Safety instructions
 - head-protection airbags 29
 - seat belt tensioners 22
 - side airbags 27
 - using child seats 31
 - using seat belts 17
 - Scrapping 351
 - Screen 71
 - Seat
 - access aid for the third row of seats 137
 - folding the rear seats 143
 - rear seats 133
 - Seat adjustment
 - rear seats 133
 - Seat belt height adjustment 21
 - Seat belts 15
 - adjusting de seat belt 19
 - adjustment 18
 - control lamp 15
 - protective function 16
 - purpose 15, 22

- safety instructions 17
- seat belt height adjustments 21
 - unfastened 17
 - with two buckles 20
- Seat belt tensioners 21
 - control lamp 24
- Seat belt with two buckles
 - fasten 20
 - twisted 20
 - unfasten 20
- Seat functions
 - access aid for the third row of seats 137
 - lumbar massage 135
- Seat heating 167
- Seats
 - adjusting the headrests 134
 - electric settings 132
 - fitting the headrest 134
 - fold down the front passenger's backrest .. 138
 - heating 167
 - incorrect positions 13
 - manual adjustment 131
 - memory function 136
 - number of seats 13
 - removing the headrest 134
- SEAT Service Mobility 339
- Seat's Mobility Service 339
- Selective unlocking system 97
- Selector lever lock 249
- Selector lever (automatic gearbox)
 - emergency unlocking 252
 - positions 248
- Selling the vehicle
 - in other countries/continents 350
- Service
 - Digital Maintenance plan 337
 - flexible service 337
 - inspection 337
 - oil change service 337
 - proof of Service 337
 - services 337
 - service sets 339
 - service works 337
 - set service intervals 337
 - terms of use 338
- Service interval display 338
- Service intervals 83
- Service notification: consult 84
- Set of vehicle keys 93
- Setup
 - Full Link 192
 - voice control 185
- Shift paddles (automatic transmission) 250
- Side airbags
 - safety instructions 27
- Sliding door 105
 - child lock 107
 - electric opening and closing 106
 - manual opening and closing 106
- SMS 235
- Snow chains 334
 - four-wheel drive 256
- Spanner symbol 84
- Spare parts 345
- Special characteristics
 - AUX mode 212
 - high pressure cleaning equipment 308
 - towing 53, 56
 - tow start 53
- trailer mode 306
 - volume reduction 177
- Speed symbol 329
- Stabilisation of the towing vehicle and trailer
 - combination 307
- Start-Stop 245
- Start-Stop system
 - disconnect and connect 247
 - driver indications 245
 - how it works 245
 - lamps 245
 - stopping and starting the engine 245
 - the engine does not turn off 245
 - the engine starts by itself 245
- Starter button 241
- Starting up the engine 241
- Start the engine by towing 54
 - special characteristics 53
- Station
 - set a station name 200
- Station names 195
- Station tracking 195
- Status display 73
 - ACT 257
 - active cylinder management status (ACT) .. 71
 - adaptive cruise control 269
 - compass indication 72
 - doors, bonnet and rear lid open 71
 - Emergency brake assistance system (Front Assist) 265
 - gear-change recommendation 72
 - instrument panel 71
 - odometer 72
 - outside temperature 72
 - selector lever positions 72, 248

- service intervals 83
- time 80
- tyre control 335
- warning and information messages 76
- Steering
 - control lamp 254
 - electromechanical steering 253
 - steering assist 254
 - steering column lock 254
- Steering assist 254
- Steering wheel
 - adjust 14
 - controls 89
 - shift paddles (automatic transmission) 250
- Steering wheel brake assist system
 - brake operation 294
- Steering wheel park assist
 - interruption 292
- Stickers and plates 350
- Storage compartment 152
 - cards 155
 - drawers 156
 - folding table 155
 - front centre console 155
 - glasses case 154
 - glove compartment 153
 - glove compartment light 124
 - instrument panel 154
 - in the front central armrest 153
 - in the roof console 154
 - on-board documentation 153
 - on the front passenger side 153
 - other storage compartments 157
 - portable rubbish bin 156
 - rear footwell area 155
 - roof console 154
- Storage compartment accessories
 - see Storage 152
- Storage compartment in the roof console ... 154
- Storage of accident data 348
- Storage of trip data 348
- Storing objects
 - bag hooks 148
 - fastening rings 145
 - fold down the front passenger's backrest .. 138
 - loading the trailer 305
 - positioning the load 140
 - positioning the luggage 140
 - roof carrier 150
 - roof carrier system 150, 151
 - trailer 301
 - trailer mode 306
- Sun blind 130
- Sun blinds
 - rear side windows 131
- Sun protection 130
- Sunroof 114
 - anti-trap function 116
 - malfunction 114
- Sunshade blind 116
 - anti-trap function (glass roof) 116
- Switch
 - hazard warning lights 122
- T**
- Tail lights
 - change a bulb 60
- Technical data 357
 - fuel consumption 357
 - load on the roof 151
 - vehicle dimensions 360
 - vertical load on the tow hitch 301
 - weights 357
- Technical modifications 346
- Telephone
 - Bluetooth® profiles 227
 - Bluetooth® settings 238
 - call lists 236
 - during a phone call 231
 - enter telephone number 232
 - favourites (quick access to the phone book) 237
 - general information 226
 - main menu 230
 - pairing a mobile phone 228
 - phonebook 233
 - places with special regulations 227
 - settings 237
 - short messages (SMS) 235
 - user profile settings 238
- TELEPHONE
 - switching the telephone management system off 229
- Temperature indicator
 - exterior 72
- Time
 - adjust 80
- Tiptronic (automatic transmission) 248, 250
- To change the battery
 - of the vehicle key 94
- To park the vehicle 290
- Top Tether 33, 35

- Top Tether System 33, 35
- Torque
wheel nuts 49
- Towable loads
loading the trailer 305
- Tow cable 303, 304
- Tow hook
control lamp 308
unlocking electrically 308
- Towing device
fitting a bicycle carrier 309
fitting later 310
malfunction 303
tow hook with electric unlocking 308
- Towing the vehicle 53, 55
automatic gearbox 55
four-wheel drive 55
front towline anchorage 56
manual gearbox 55
rear towline anchorage 57
special characteristics 53, 56
tow bar 55
towing cable 55
towing prohibited 55
with towing device 55
- Traction control system 288
- Traction control system (ASR) 289
- Traffic information (TP) 200
- Trailer 301
adjusting the headlights 306
anti-theft alarm 304
blind spot detector (BSD) 282
connecting 303
exterior mirrors 303
hitching 303
LED tail lights 303, 304
loading 305
malfunction 303
optical parking system 297
parking aid 295
power socket 304
retrofitting a towing bracket 310
special characteristics 282
stabilisation of the towing vehicle and trailer combination 307
tail lights 303, 304
technical requirements 302
towable loads 305
towing cable 303, 304
trailer mode 306
unlocking the tow hook electrically 308
vertical load on the tow hitch 301, 305
- Trailer mode
see Trailer 301
- Transport
luggage net 148
rail system with fasteners 145
- Transportation of children 30
- Trips abroad
headlights 124
petrol 258
- Turning off the lights 117
- Turning on the lights 117
- Turning the ignition on and off 241
- Turn signal lever 119
- Tyre Mobility System
see Anti-puncture kit 42
- Tyre pressure 331
- Tyre pressure loss indicator
Tyre pressure monitor indicator 335
- Tyre pressure monitor system 334
- Tyre profile 332
- Tyre repair kit 41
see also Anti-puncture kit 42
- Tyre repairs 42
- Tyres 328
accessories 329
change 45
directional tread pattern 49
foreign objects inserted 329
new tyres 329
speed symbol 329
tread wear indicators 332
tyre pressure 331
useful life 331
with directional tread pattern 329
- Tyre tread depth 332
- Tyre wear 332
- ## U
- Unlock and lock
by remote control 97
doors 103
electric sliding door 106
sliding door 105
with Keyless Access 98
with the central locking switch 97
- USB 239
connecting external data media 211
load devices 240
- USB/AUX-IN input 239
- USB port 152

- V**
- Vanity mirror 130
 - Vehicle
 - data label 357
 - identification data 357
 - identification number 357
 - parking on inclines 290
 - parking on upward slopes 290
 - raise 47
 - recycling 351
 - unlocking and locking with Keyless Access 98
 - vehicle ID number 357
 - Vehicle battery
 - electrolyte level 326
 - Vehicle care
 - wiper blade service position 50
 - Vehicle conservation products 340
 - Vehicle dimensions 360
 - Vehicle maintenance 340
 - antenna built into the glass 351
 - Vehicle seats 13
 - Vehicle tool kit 41
 - Vehicle wallet compartment 153
 - Vertical load on the tow hitch 301
 - loading the trailer 305
 - Voice control 91
 - available languages 183
 - operation 183
 - settings 185
 - tips 183
- W**
- Warning symbols
 - see Control and warning lamps 87
 - Warning triangle 40, 122
 - Warranty 340
 - Washing the vehicle
 - conserving the exterior of the vehicle 340
 - high pressure cleaning equipment 340
 - sensors 290, 294
 - special characteristics 111
 - Weights 357
 - Wheel balance 331
 - Wheel nuts 46, 332
 - anti-theft device 46
 - caps 46
 - torque 49
 - Wheels 328
 - change 45, 48
 - changing 332
 - changing a wheel 45
 - new wheels 329
 - snow chains 334
 - wheel nuts 332
 - wheel trim 45
 - Wheel spanner 41
 - Wheel trim 45
 - remove 46
 - Window controls 113
 - Windows
 - automatic opening/closing 113
 - automatic operation 113
 - convenience closing 113
 - convenience opening 113
 - Window washer
 - window washer lever 125
 - Window washer system 324
 - Window washer water
 - check 324
 - filling quantities 324
 - refill 324
 - Windscreen heating 162
 - Windscreen washer 125
 - Windscreen washer fluid
 - control lamp 125
 - Windscreen wipers 125
 - functions 126
 - headlight washer system 126
 - lift the blade 50
 - rain sensor 127
 - reposition the blade 50
 - service position 50
 - special characteristics 125
 - thermal washing ejectors 126
 - Winter
 - menu configuration 75
 - Winter conditions
 - sunroof 114
 - trailer 301
 - Winter tyres 333
 - four-wheel drive 256
 - Wiper and rear window wiper blades
 - cleaning 50
 - replacement 50
 - service position 50
 - Wiper blades
 - cleaning 342
- X**
- XDS 288

SEAT S.A. is permanently concerned about continuous development of its types and models. For this reason we ask you to understand, that at any given time, changes regarding shape, equipment and technique may take place on the car delivered. For this reason no right at all may derive based on the data, drawings and descriptions in this current handbook.

All texts, illustrations and standards in this handbook are based on the status of information at the time of printing. Except for error or omission, the information included in the current handbook is valid as of the date of closing print.

Re-printing, copying or translating, whether total or partial is not allowed unless SEAT allows it in written form.

SEAT reserves all rights in accordance with the "Copyright" Act.

All rights on changes are reserved.

 This paper has been manufactured using bleached non-chlorine cellulose.

© SEAT S.A. - Reprint: 15.11.21

Inglés 7N5012720BS (11.21)



7N5012720BS

