





Foreword

This Instruction Manual and its corresponding supplements should be read carefully to familiarise yourself with your vehicle.

Besides the regular care and maintenance of the vehicle, its correct handling will help preserve its value.

For safety reasons, note the information concerning accessories, modifications and part replacements.

If selling the vehicle, give all of the onboard documentation to the new owner, as it should be kept with the vehicle.

Table of Contents

Manual structure	5	Unlocking and locking	71	Park Assist system*	202
		Vehicle key set	71	Rear Assist system*	207
		Central locking and locking system	74	Cruise control system*	212
Content	6	Doors	80	Lane Assist system*	215
		Sliding doors	81	Sign Assist*	218
		Tailgate	84	Tyre monitoring systems	221
		Electric windows	89		
		Panorama sliding sunroof*	92	Practical tips	225
Safety First	7	Lights and visibility	95	Driving and the environment	225
Safe driving	7	Lights	95	Running-in	225
Dear SEAT Driver	7	Sun blind	103	Ecological driving	225
Tips for driving	7	Windscreen wiper and washer	105	Engine management and exhaust gas purification system	228
Adjusting the seat position	10	Rear vision mirror	110	Trailer towing	231
Transporting objects	13	Seats and storage compartments	114	Introduction	231
Seat belts	16	Seat adjustment	114	Driving with a trailer	233
Brief introduction	16	Seat functions	117	Vehicle maintenance and cleaning	242
Why wear seat belts?	19	Head restraints	123	Care and cleaning the vehicle exterior	242
Seat belts	21	Centre armrest	125	Caring for and cleaning the vehicle interior	249
Seat belt tensioners	26	Loading luggage compartment	125	Notes for the user	255
Airbag system	28	Roof carrier system*	138	Accessories, parts replacement and modifications	257
Brief introduction	28	Storage compartments	141	Accessories, replacement of parts and modifications	257
Airbag system	31	Cup holders	148	Checking and refilling levels	264
Child safety	39	Ashtray and cigarette lighter*	150	Filling the tank	264
Child seats (accessories)	39	Electrical sockets	151	Fuel	267
Integrated child seat	45	Air conditioning	155	Selective Catalytic Reduction* (AdBlue)	271
		Climate Control	155	Working in the engine compartment	275
Operating instructions	53	Auxiliary heater* (additional heater)	163	Engine oil	279
		Driving	167	Engine coolant	283
Cockpit	53	Steering	167	Vehicle battery	288
Overview	53	Stopping and starting the engine	170		
Instrument panel	54	Changing gear	174		
Instruments	57	Braking, stopping and parking	183		
SEAT information system	62	Start assist systems	194		
		Parking sensor system*	198		

Wheels and tyres	293	Diesel engine 2.0 TDI CR 125 kW (170 PS)	
Wheels	293	Automatic	361
Wheel trims*	304	Dimensions and capacities	363
Changing a wheel*	305		
If and when	312	Index	365
In case of emergency	312		
Emergency locking and unlocking	314		
Tools*	320		
Fuses	322		
Changing bulbs	326		
Starting assistance	337		
Towing and tow starting	340		
Technical Specifications	344		
Description of specifications	344		
Important information	344		
Information on fuel consumption	346		
Towing a trailer	347		
Wheels	347		
Technical specifications	348		
Checking fluid levels	348		
Petrol engine 1.4 110 kW (150 PS)	349		
Petrol engine 1.4 110 kW (150 PS) Automatic ..	350		
Petrol engine 2.0 147 kW (200 PS) Automatic ..	351		
Diesel engine 2.0 TDI CR 85 kW (115 PS)	352		
Diesel engine 2.0 TDI CR 100 kW (136 PS)	354		
Diesel engine 2.0 TDI CR 100 kW (136 PS)			
Automatic	355		
Diesel engine 2.0 TDI CR 103 kW (140 PS)	356		
Diesel engine 2.0 TDI CR 103 kW (140 PS)			
Automatic	357		
Diesel engine 2.0 TDI CR 103 kW (140 PS) All-			
wheel drive	359		
Diesel engine 2.0 TDI CR 125 kW (170 PS)	360		

Manual structure

What you should know before reading this manual

This manual contains a description of the **equipment** supplied with the vehicle at the time of press. Some of the equipment hereunder described will not be available until a later date, or is only available in certain markets.

Because this is a general manual for the ALHAMBRA, some of the equipment and functions that are described in this manual are not included in all types or variants of the model; they may vary or be modified depending on the technical requirements and on the market; this is in no way deceptive advertising.

The **illustrations** are intended as a general guide and may vary from the equipment fitted in your vehicle in some details.

The **direction indications** (left, right, front, rear) appearing in this manual refer to the normal forward working direction of the vehicle except when otherwise indicated.

The **equipment marked with an asterisk**** is fitted as standard only in certain versions, and is only supplied as optional extras for some versions, or are only offered in certain countries.

- © All registered marks are indicated with ©. Although the copyright symbol does not appear, it is a copyrighted mark.
- The section is continued on the following page.
- Marks the **end of a section**.



WARNING

Texts preceded by this symbol contain information on safety. They warn you about possible dangers of accident or injury.



CAUTION

Texts with this symbol draw your attention to potential sources of damage to your vehicle.



For the sake of the environment

Texts preceded by this symbol contain relevant information concerning environmental protection.



Note

Texts preceded by this symbol contain additional information. ■

Content

This manual is structured to provide the information you need in an organised way. The content of this Manual is divided into **sections** which belong to **chapters** (e.g. “Air conditioning”). The entire manual is divided into five large parts which are:

1. Safety First

Information on the vehicle equipment relating to passive safety such as seat belts, airbags, seats, etc.

2. Operating instructions

Information about the distribution of controls in the driver position of your vehicle, about the seat adjustment possibilities, about how to create a suitable climate in the passenger compartment, etc.

3. Practical tips

Advice relating to the driving, caring and maintenance of your vehicle and certain problems you can solve yourself.

4. Technical specifications

Figures, data, dimensions and measurements (for example fuel consumption) of your vehicle.

5. Alphabetic index

At the end of this manual there is a detailed alphabetical index, this will help you to rapidly find the information you require. ■

Safety First

Safe driving

Dear SEAT Driver

Safety first!

This chapter contains important information, tips, suggestions and warnings that you should read and consider for both your own safety and for your passengers' safety.

WARNING

- This manual contains important information about the operation of the vehicle, both for the driver and the passengers. The other sections of the owner's manual also contain further information that you should be aware of for your own safety and for the safety of your passengers.
- Ensure that the onboard documentation is kept in the vehicle at all times. This is especially important when lending or selling the vehicle to another person.

when driving over kerbs, or along dirt tracks or rough roads... SEAT recommends you have the guard fitted by a SEAT dealer.

Additional information and warnings:

- Ensure you are correctly seated ⇒ page 10
- Transporting ⇒ page 13
- Starting, changing gears, parking ⇒ page 170
- Ecological driving ⇒ page 225
- Notes for the user ⇒ page 255

WARNING

Driving under the influence of alcohol, drugs, medication or narcotics may result in severe accidents and even loss of life.

- Alcohol, drugs, medication and narcotics may significantly alter perception, affect reaction times and safety while driving, which could result in the loss of control of the vehicle.

Tips for driving

Introduction

Depending upon how you expect to use your vehicle, it may a good idea to protect the engine from below. A guard underneath the engine may help to reduce the risk of damage to the lower part of the vehicle and the oil sump

Preparing for the journey and safe driving

Check list

For your own safety, for the safety of passengers in the car, and for that of other road users, the following should be checked before and during each journey ⇒  ▶

- Check that the lights and turn signals operate correctly.
- Check the tyre pressures (⇒ page 293) and level of fuel (⇒ page 264).
- Ensure there is good visibility through all the windows.
- Make sure that all objects and bags in the storage compartments, in the luggage compartment and, where applicable, on the roof, are securely fastened ⇒ page 13.
- Ensure there is nothing obstructing the free passage of the foot pedals.
- Use child retention systems appropriate for the child's body weight and height ⇒ page 39.
- Correctly adjust front seat, head rests and rear-view mirrors to suit your height ⇒ page 10.
- Wear close-fitting shoes which do not prevent you from using the pedals correctly.
- The driver's floor mat should be fixed to the floor, leaving the pedal area unobstructed.
- Before starting out, ensure you are correctly seated and remain in this position throughout the journey. This applies to all passengers in the vehicle ⇒ page 10.
- Correctly fasten your seat belt before starting to drive and keep it securely fastened throughout the journey. This applies to all passengers in the vehicle ⇒ page 21.
- Never carry more passengers than the number of available seats and seat belts in your vehicle.
- Never drive with impaired faculties (for example, due to medication, alcohol or drugs).
- Do not allow yourself to be distracted from the traffic, for example, to reset or switch on a menu, by other passengers or to answer a phone call.
- Always try to adapt the speed of the vehicle and your style of driving to the condition of the ground or the road and to weather and traffic conditions.
- Observe the highway code and speed limits.

- On long journeys, rest at regular intervals (at least every two hours).
- If carrying animals, make sure they are correctly restrained in accordance with their weight and size.



WARNING

Always observe traffic regulations and speed limits and try to anticipate traffic movements. Correctly anticipating traffic situations may mean the difference between arriving safe and sound at your destination or having a serious accident.



Note

Regular servicing of your vehicle not only helps to keep it in good working order but also helps to ensure road safety. Therefore, please ensure the vehicle is taken for service as indicated in the Maintenance Programme. If the vehicle is subjected to hard use, it may require certain maintenance work before the next service date. Hard use may involve frequent driving in traffic jams, driving in dusty areas or frequent use of the tow-bar. For further information, please refer to a SEAT dealer or specialised workshop. ■

Driving abroad

Check list

In some countries, certain safety regulations and requirements are in force relating to exhaust gas emissions, which differ from the technical characteristics of the vehicle. Before travelling abroad, SEAT recommends you consult a SEAT dealer about the legal requirements and the following points:

- Does the vehicle need technical modifications for driving abroad, for example, adjustment of the headlamps?
- Does the vehicle have all the tools, diagnostics equipment and spare parts required for inspections and repairs?
- Are there any SEAT dealers in the destination country? ▶

- For petrol vehicles: Is unleaded petrol available at the right octane rating?
- For diesel engines: Is diesel fuel available with a low sulphur content?
- Are a suitable engine oil (⇒ page 279) and other engine fluids complying with SEAT specifications available in the destination country?
- Will the navigation system fitted at the factory operate correctly in the destination country with the available navigation data?
- Are special tyres required in the destination country?



CAUTION

SEAT does not accept liability for any damage to the vehicle due to the use of a lower quality fuel, an inadequate service or the non-availability of genuine spare parts. ■

Driving along flooded roadways

To prevent damage to the vehicle when driving through water, for example, along a flooded road, please observe the following:

- Check the depth of the water before entering the flooded zone. The water should **never** come above the lower edge of the bodywork ⇒ .
- Do not drive faster than a pedestrian.
- Do not stop in the water, use reverse gear or switch off the engine.
- Oncoming traffic will cause waves which raise the level of the water, making it difficult to cross the water.



WARNING

When driving through water, mud, melted snow, etc., please remember that due to damp or frozen brake discs and shoes in winter, the braking effect may be delayed, therefore the required braking distance is greater.

- **Dry the brakes and remove ice by braking carefully. Ensure that you are not endangering other road-users or breaking traffic regulations in the process.**
- **After driving through water, avoid sudden sharp manoeuvres.**



CAUTION

- Driving through flooded areas may severely damage vehicle components such as the engine, transmission, running gear or electrical system.
- Never drive through salt water as salt causes corrosion. Always rinse any parts of the vehicle which have been in contact with salt water. ■

Adjusting the seat position

Introduction

Number of seats

Depending on the equipment, your vehicle has a total of **five** or **seven** seats. Each seat is equipped with a seat belt.

Equipment	Seats in the front	Seats in the second row	Seats in the third row
5 seats	2	3	–
7 seats	2	3	2

Additional information and warnings:

- Seat functions ⇒ page 117
- Seat belts ⇒ page 21
- Airbag system ⇒ page 31
- Child seats (accessories) ⇒ page 39

WARNING

An incorrect sitting position in the vehicle can lead to severe injuries or death in the event of sudden braking or manoeuvres, collision or accidents or if the airbag deploys.

- Before the vehicle moves, assume the proper sitting position and maintain it throughout the trip. This also includes fastening the seat belt.
- Never transport more people than there are seats with a seat belt available in the vehicle.

WARNING (Continued)

- Children must always be protected with an approved child restraint system suited to their height and weight ⇒ page 39, ⇒ page 31.
- Always keep your feet in the footwell while the vehicle is in motion. Never, for example, put your feet on the surface of a seat or on the dash panel and never put them out of a window. Otherwise the airbag and seat belt offer insufficient protection and the risk of injury in the event of an accident is increased.

WARNING

Before every trip, adjust the seat, the seat belt and the head restraints and instruct your passengers to fasten their seat belts properly.

- Move the front passenger seat back as far as possible.
- Adjust the driver's seat so that there is a distance of at least 25 cm (10 inches) between the centre of your chest and the hub of the steering wheel. Adjust the driver's seat so that you are able to press the accelerator, brake and clutch pedals to the floor with your knees slightly angled and that the distance between your knees and the dash panel is at least 10 cm (4 inches). If your physical constitution prevents you from meeting these requirements, contact a Technical Service to make any modifications required.
- Never drive with the backrest tilted far back. The further the backrests are tilted to the rear, the greater the risk of injury due to incorrect positioning of the belt web or to the incorrect sitting position.
- Never drive with the backrest tilted forwards. Should a front airbag deploy, it could throw the backrest backwards and injure the passengers of the rear seats.
- Sit as far away as possible from the steering wheel and the dash panel.

 **WARNING (Continued)**

- **Keep your back straight and resting completely against the backrest and the front seats correctly adjusted. Never place any part of your body in the area of the airbag or very close to it.**
- **If passengers on the rear seats are not sitting in an upright position, the risk of severe injury due to incorrect positioning of the belt web increases.**

 **WARNING**

Incorrect seat adjustment may lead to accidents and severe injuries.

- **Only adjust the seats when the vehicle is stationary, as the seats could move unexpectedly while the vehicle is in motion and you could lose control of the vehicle. Furthermore, an incorrect position is adopted when adjusting the seat.**
- **Only adjust the height, backrest and forwards or backwards position of the seat when there is nobody in the seat adjustment area.**
- **There must be no objects blocking the seat adjustment area.**
- **Only adjust the height, angle and longitudinal position of the rear seats when nobody is in the way.**
- **The seat adjustment and lock areas must be kept clean.**

Danger of injuries due to an incorrect sitting position

If the seat belts are worn incorrectly or not at all, the risk of severe injuries increases. Seat belts can provide optimal protection only if the belt web is properly worn. The seat belt cannot offer its full protection if the belt web is not positioned correctly. This could result in severe and even fatal injuries. The risk of severe or fatal injuries is especially increased when a deploying airbag strikes an occupant who has assumed an incorrect sitting position. The driver is responsible for all passengers in the vehicle, particularly children.

The following list shows just some examples of incorrect sitting positions which can be dangerous to all occupants.

Whenever the vehicle is in motion:

- Never stand in the vehicle.
- Never stand on the seats.
- Never kneel on the seats.
- Never tilt your backrest too far to the rear.
- Never lean against the dash panel.
- Never lie on the rear bench.
- Never sit on the front edge of a seat.
- Never sit sideways.
- Never lean out of a window.
- Never put your feet out of a window.
- Never put your feet on the dash panel.
- Never put your feet on the surface of a seat or backrest.
- Never travel in a footwell.
- Never sit on the armrests.
- Never travel on a seat without wearing the seat belt.
- Never carry any person in the luggage compartment.

 **WARNING**

Every incorrect sitting position increases the risk of severe or fatal injuries in the event of accidents or sudden braking or manoeuvres.

- **All passengers must assume the proper sitting position and be properly belted in while travelling.**
- **Occupants in incorrect sitting positions, not wearing their seat belt or too close to the airbag run the risk of suffering severe or fatal injuries, particularly if the airbag deploys and hits an occupant sitting in an incorrect position.**

Correct sitting position

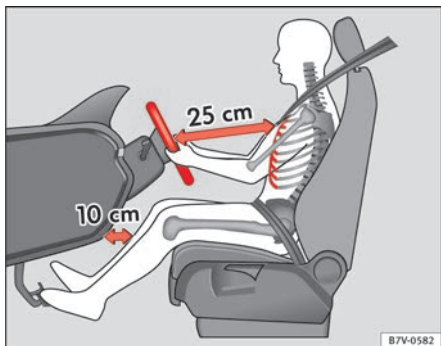

Fig. 1 The correct distance between the driver and the steering wheel must be at least 25 cm (10 inches).

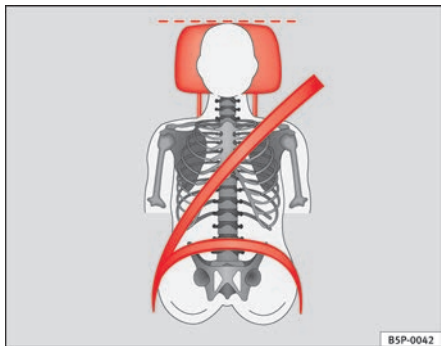

Fig. 2 Correct belt web and head restraint positions.

The correct sitting positions for the driver and passengers are shown below.

If your physical constitution prevents you from maintaining the correct sitting position, contact a Technical Service for help with any special devices. The

seat belt and airbag can only provide optimum protection if a correct sitting position is adopted. SEAT recommends visiting a Technical Service.

For your own safety and to reduce the risk of injury in the event of an accident or sudden braking or manoeuvre, SEAT recommend the following positions:

Valid for all vehicle occupants:

- Adjust the head restraint so that its upper edge is at the same level as the top of your head, or as close as possible to the same level as the top of your head and under no circumstances below eye level. Keep the back of your neck as close as possible to the head restraint ⇒ fig. 1 and ⇒ fig. 2.
- Short people must lower the head restraint completely, even if your head is below its upper edge.
- Tall people must raise the head restraint completely.
- Adjust the backrest to an upright position so that your back rests completely against it.
- Always keep your feet in the footwell while the vehicle is in motion.
- Adjust and fasten your seat belt correctly ⇒ page 21.

Also valid for the driver:

- Adjust the steering wheel so that there is a distance of at least 25 cm (10 inches) between it and your chest ⇒ fig. 1 and so that you can hold the steering wheel with both hands on the outside of the ring at the 9 o'clock and 3 o'clock positions with your arms slightly bent.
- The adjusted steering wheel must face your chest and not your face.
- Adjust the driver's seat forwards or backwards so that you are able to press the accelerator, brake and clutch pedals to the floor with your knees slightly angled and the distance between your knees and the dash panel is at least 10 cm (4 inches) ⇒ fig. 1.
- Adjust the height of the driver's seat so that you can easily reach the top of the steering wheel.
- Keep both feet in the footwell so that you have the vehicle under control at all times. ▶

Also valid for the front passenger:

- Move the front passenger seat back as far as possible for optimum protection should the airbag deploy.

Transporting objects

Introduction

Always transport heavy loads in the trunk and place the seat backs in a vertical position. Always use the anchors provided with suitable rope to secure heavy objects. Never overload the vehicle. Both the carrying capacity as well as the distribution of the load in the vehicle have effects on the driving behaviour and braking ability ⇒ .

Additional information and warnings:

- Tailgate ⇒ page 84
- To lower the passenger seat back ⇒ page 117
- Light ⇒ page 95
- Luggage compartment ⇒ page 125
- Roof carrier ⇒ page 138
- Towing mode ⇒ page 233
- Wheels and tyres ⇒ page 293

**WARNING**

Unsecured or incorrectly secured objects can cause serious injury in case of a sudden manoeuvring or breaking or in case of an accident. This is especially true when objects are struck by a detonating airbag and fired through the vehicle interior. To reduce the risks, please note the following:

- Secure all objects in the vehicle. Always keep equipment and heavy objects in the luggage compartment.
- Always secure objects with suitable rope or slings so that they cannot enter the areas around the frontal or side airbags in case of sudden braking or an accident.
- Always ensure that objects inside the vehicle cannot move into the area of the bags while driving.
- While driving, always keep object compartments closed.
- Remove all objects from the passenger seat when this is folded down. When the seat back is folded down, it presses on small and light objects and these are detected by the weight sensor on the seat; this sends false information to the airbag control unit.
- While the backrest of the front passenger's seat is folded, the frontal airbag must remain disconnected and the **PASSENGER AIRBAG OFF**  light on.
- Objects secured in the vehicle should never be placed in such a way as to make passengers sit in an incorrect position.
- If secured objects occupy a seat then this should not be occupied or used by anybody.

 **WARNING**

The driving behaviour and braking ability change when transporting heavy and large objects.

- Adjust your speed and driving style to visibility, road, traffic and weather conditions.
- Accelerate gently and carefully.
- Avoid sudden braking and manoeuvres.
- Brake early.

Transporting a load

Secure all objects in the vehicle

- Distribute the load throughout the vehicle, on the roof and in a trailer as uniformly as possible.
- Transport heavy objects as far forward as possible in the luggage compartment and lock the seat backs in the vertical position.
- Secure luggage in the luggage compartment with suitable straps on the fastening rings ⇒ page 125.
- Check the headlight adjustment ⇒ page 95.
- Use the suitable tyre pressure according to the load being transported. Read the tire inflation information label ⇒ page 293.
- For vehicles with a tire pressure indicator, change the vehicle load status ⇒ page 221.

 **CAUTION**

Objects on the shelf could chafe against the wires of the heating element in the rear window and cause damage.

 **Note**

Please note the information about loading a trailer ⇒ page 233 and the roof carrier system ⇒ page 138.

Driving with the tailgate open

Driving with the tailgate open creates an additional risk. Secure all objects and secure the tailgate correctly and take all measures possible to reduce toxic gases from entering the vehicle.

 **WARNING**

Driving with the tailgate unlocked or open could cause serious injuries.

- Always drive with the tailgate closed.
- Secure all objects in the vehicle. Loose items could fall out of the vehicle and injure other road users or damage other vehicles.
- Drive particularly carefully and think ahead.
- Avoid sudden manoeuvres and braking given that this could cause an uncontrolled movement of the open tailgate.
- When transporting objects that protrude out of the luggage compartment, indicate them suitably. Observe legal requirements.
- If objects must project out of the luggage compartment, the tailgate must never be used to “secure” or “attach” objects.
- If a baggage rack is fitted on the tailgate, it should be removed before travelling with the tailgate open.

 **WARNING**

Toxic gases may enter the vehicle interior when the tailgate is open. This could cause loss of consciousness, carbon monoxide poisoning, serious injury and accidents.

- To avoid toxic gases entering the vehicle always drive with the tailgate closed.
- In exceptional circumstances, if you must drive with the tailgate open, observe the following to reduce the entry of toxic gases inside the vehicle:
 - Close all windows and the sliding roof.
 - Turn off the air recirculation for the heating and air conditioning.
 - Open all of the air outlets in the dashboard.
 - Turn the heating fan and heater to the highest level.

 **CAUTION**

An open tailgate changes the length and height of the vehicle.

Driving a loaded vehicle

For the best handling when driving a loaded vehicle, note the following:

- Secure all objects ⇒ page 14.
- Accelerate gently and carefully.
- Avoid sudden braking and manoeuvres.
- Brake early.
- If necessary, read the instructions for driving with a trailer ⇒ page 233.
- If necessary, read the instructions for driving with a roof carrier system ⇒ page 138.

 **WARNING**

A sliding load could considerably affect the stability and safety of the vehicle resulting in an accident with serious consequences.

- Secure loads correctly so they do not move.
- When transporting heavy objects, use suitable ropes or straps.
- Lock the seat backs in vertical position.

Specific vehicle weight information

The instructions in the official vehicle documents take precedence. All the technical data provided in this documentation is applicable to the basic model. The vehicle data label in the Maintenance Programme or the vehicle documents show which engine is installed in your vehicle.

The figures may be different depending on if additional equipment is fitted, for different models and for special vehicles.

 **WARNING**

Exceeding the maximum authorised weight and the load on the axles could cause damage to the vehicle, accidents and serious injuries.

- The real load on the axles should never exceed the maximum permitted.
- The load and its distribution in the vehicle have effects on the vehicle handling and the braking ability. Always drive at a suitable speed.

 **CAUTION**

Distribute the load as uniformly and as low down on the vehicle as possible. When transporting heavy objects in the trunk/boot, these should be placed as far forward as possible or over the rear axle to have as little influence on handling as possible.

Seat belts

Brief introduction

Introduction

Check the condition of all the seat belts at regular intervals. If you notice that the belt webbing, fittings, retractor mechanism or buckle of any of the belts is damaged, the belt must be replaced immediately by a specialist workshop ⇒ ⚠. The specialist workshop must use the appropriate spare parts corresponding to the vehicle, the equipment and the model year. SEAT recommends visiting a Technical Service.

Additional information and warnings:

- Adjust the seat position ⇒ page 10
- Airbag system ⇒ page 31
- Child seats (accessories) ⇒ page 39
- Integrated child seats ⇒ page 45
- Accessories, parts replacement, repairs and modifications ⇒ page 257

WARNING

Unbuckled or badly buckled seat belts increase the risk of severe or even fatal injuries. The seat belt cannot offer its full protection if it is not fastened and used correctly.

- **Seats belts are the most effective ways of reducing the risk of sustaining severe or fatal injuries in the event of an accident. Seat belts must be correctly fastened when the vehicle is in motion to protect the driver and all vehicle occupants.**

WARNING (Continued)

- **Before each trip, every occupant in the vehicle must sit properly, correctly fasten the seat belt belonging to his or her seat and keep it fastened throughout the trip. This also applies to other occupants when driving in town.**
- **When travelling, children must be secured in the vehicle with a child restraint system suitable for their weight and height and with the seat belts correctly fastened ⇒ page 39.**
- **Instruct your passengers to fasten their seat belts properly before driving off.**
- **Insert the latch plate into the buckle for the appropriate seat and ensure it is engaged. Using the latch plate in the buckle of another seat will not protect you properly and may cause severe injuries.**
- **Do not allow liquids or foreign bodies to enter the buckle fastenings. This could damage the buckles and seat belts.**
- **Never unbuckle your seat belt when the vehicle is moving.**
- **Never allow more than one passenger to share the same seat belt.**
- **Never hold children or babies on your lap sharing the same seat belt.**
- **Loose, bulky clothing (such as a jacket) impairs the proper fit and function of the seat belt.**

WARNING

It is extremely dangerous to drive using damaged seat belts and could result in serious injury or loss of life.

- **Avoid damaging the seat belt by jamming it in the door or the seat mechanism.**

⚠ WARNING (Continued)

- If the fabric or other parts of the seat belt are damaged, the seat belts could break in the event of an accident or sudden braking.
- Always have damaged seatbelts replaced immediately by seat belts approved for the vehicle in question by SEAT. Seat belts which have been worn in an accident and stretched must be replaced by a specialised workshop. Renewal may be necessary even if there is no apparent damage. The belt anchorage should also be checked.
- Never attempt to repair, modify or remove a seat belt yourself. All repairs to seat belts, retractors and buckles must be carried out by a specialist workshop.

Warning lamp



Fig. 3 Warning lamp on the instrument panel



Fig. 4 Example of seat belt status display for the rear seats (here, a 7-seat vehicle) on the instrument panel, above the second row and below the third row of seats.

Lights up or flashes	Possible cause	Solution
	Driver's seat belt not fastened or front passenger's seat belt not fastened if the front passenger's seat is occupied.	Fasten seat belts!
	Objects on the front passenger's seat.	Remove any objects from the front passenger's seat and store them safely.

Some control and warning lamps on the instrument panel will come on to check certain functions when the ignition is switched on. They will switch off after a few seconds.

A signal will be heard for a maximum of 90 seconds if the seat belts are not fastened as the car drives off and reaches a speed of more than 25 km/h or if the seat belts are unfastened while the vehicle is in motion. The seat belt warning lamp will also flash.

The warning lamp  does not switch off until the driver and front passenger fasten their seat belts while the ignition is switched on.

Seat belt status display for rear seats

The seat belt status display on the instrument panel informs the driver, when the ignition is switched on, whether any passengers in the rear seats have fastened their seat belts. The symbol  indicates that the passenger in this seat has fastened “his or her” seat belt ⇒ [fig. 4](#).

The seat belt status is displayed for around 30 seconds when a seat belt in the rear seats is fastened or unfastened. You can switch off this display by pressing the  button.

The seat belt status flashes for a maximum of 30 seconds when a seat belt in the rear seats is unfastened while the vehicle is in motion. A signal will also be heard if the vehicle is travelling at over 25 km/h.

The rear seat display can be enabled or disabled by a Technical Service.



WARNING

Unbuckled or badly buckled seat belts increase the risk of severe or even fatal injuries. The optimal protection from seat belts can be achieved only if you use them properly.

Why wear seat belts?

Frontal collisions and the laws of physics

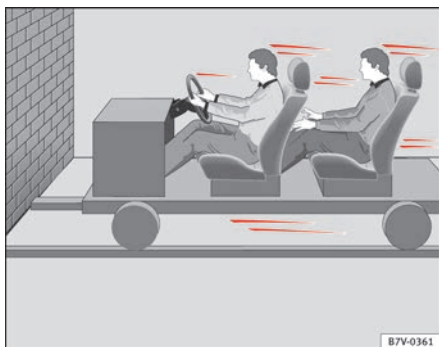

Fig. 5 Vehicle about to hit a wall: the occupants are not wearing seat belts.



Fig. 6 The vehicle hits the wall: the occupants are not wearing seat belts.

It is easy to explain how the laws of physics work in the case of a head-on collision: when a vehicle starts moving \Rightarrow fig. 5, this is a certain amount of energy known as kinetic energy both in the vehicle and in the occupants.

The higher the speed and the greater the weight of the vehicle, the more energy there is to be absorbed in an accident.

The most significant factor, however, is the speed of the vehicle. If the speed doubles from 25 km/h to 50 km/h, for example, the kinetic energy is multiplied by four.

The amount of kinetic energy depends on the speed of the vehicle and the weight of the vehicle and its passengers. The higher the speed and the greater the weight of the vehicle and the occupants, the more energy there is to be absorbed in an accident.

Passengers not wearing seat belts are not “attached” to the vehicle. As a result, in a frontal collision they will continue to move forward at the speed their vehicle was travelling just before the impact until something stops them! Because the passengers in our example are not restrained by seat belts, all of the passengers' kinetic energy has to be absorbed at the point of impact \Rightarrow fig. 6.

At speeds of 30 km/h to 50 km/h, the forces acting on bodies in a collision can easily exceed one tonne (1000 kg). At greater speed these forces are even higher.

This example applies not only to head-on collisions, but to all accidents and collisions. ■

Dangers of not using the seat belt



Fig. 7 A driver not wearing a seat belt is thrown forward violently.



Fig. 8 The unbelted rear passenger is thrown forward violently, hitting the driver wearing a seat belt.

Many people believe that the occupants can protect themselves with their hands in a minor collision. This is false!

Even at low speeds, the forces acting on the body in a collision are so great that it is not possible to brace oneself with just one's arms and hands. In a frontal collision, unbelted passengers are thrown forward and will make violent contact with the steering wheel, dash panel, windscreen or whatever else is in the way ⇒ fig. 7.

The airbag system is not a substitute for seat belts. When triggered, airbags provide only additional protection. Airbags do not deploy in all types of accident. All occupants (including the driver) must be wearing seat belts properly during the trip, even if the vehicle is equipped with airbag systems. This will reduce the risk of critical or fatal injuries in the event of an accident – regardless of whether an airbag is fitted for the seat.

The airbag is only deployed once. To achieve the best possible protection, the seat belt must always be worn properly so that you will be protected in accidents in which no airbag is deployed. Vehicle occupants not wearing belts could be thrown from the vehicle and sustain even more severe or fatal injuries.

It is also important for the rear passengers to wear seat belts properly, as they could otherwise be thrown forward violently in an accident. Rear passengers who do not use seat belts endanger not only themselves but also the driver and other occupants ⇒ fig. 8. ■

Seat belt protection



Fig. 9 Drivers with properly worn seat belts will not be thrown forward in the event of sudden braking.

Wearing a correctly fastened seat belt can significantly change the situation. Properly worn seat belts hold the vehicle occupants in the correct sitting positions and substantially reduce the kinetic energy in the event of an accident. Seat belts also help to prevent uncontrolled movements that could lead to severe injuries. In addition, properly worn seat belts reduce the danger of being thrown from the car ⇒ fig. 9.

Passengers wearing their seat belts correctly benefit greatly from the ability of the belts to absorb kinetic energy. The front crumple zones and other passive safety features (such as the airbag system) are also designed to absorb the kinetic energy generated in a collision. Taken together, all these features reduce the energy released and decrease the risk of injury.

Our examples describe frontal collisions. Of course, properly worn seat belts substantially reduce the risk of injury in all other types of accidents. This is why it is so important to fasten seat belts before every trip, even when just driving “around the corner”. Ensure that your passengers wear their seat belts as well.

Accident statistics have shown properly worn seat belts to be an effective means of considerably reducing the risk of severe injury and improving the chances of survival in a serious accident. Furthermore, properly worn seat belts improve the protection provided by deployed airbags in the event of an accident. For this reason, wearing a seat belt is required by law in most countries.

Although your vehicle is equipped with airbags, the seat belts must be fastened and worn. The front airbags, for example, are only triggered in some frontal accidents. The front airbags will not be triggered during minor frontal collisions, minor side collisions, rear collisions, rolls or accidents in which the airbag trigger threshold value in the control unit is not exceeded.

Therefore, you should always wear your seat belt and ensure that your passengers have fastened their seat belts properly before you drive off! ■

Seat belts

Using seat belts

Checklist

Using seat belts ⇒ ⚠:

- Check the condition of all the seat belts at regular intervals.
- Keep the seat belts clean.
- Keep the belt web, the latch plate and the buckle free of foreign bodies and liquids.
- Do not jam or damage the seat belt or the latch plate when closing the door, for example.
- Never remove, modify or repair the seat belt or belt fastening mechanisms.
- Fasten your seat belt properly before each trip and keep it fastened. ▶

Twisted seat belt

If it is difficult to remove the seat belt from the guide, the seat belt may have become twisted inside the side trim after being wound too quickly on unfastening:

- Pull out the seat belt completely, carefully pulling on the latch plate.
- Untwist the belt and guide it back, assisting it by hand.

The seat belt must be fastened even if it is impossible to untwist it. In this case, the twisted area must not be in an area in direct contact with your body. Have the seat belt untwisted urgently by a Technical Service.



WARNING

An improperly handled seat belt increases the risk of sustaining severe or fatal injuries.

- Regularly check that the seat belts and their components are in perfect condition.
- Always keep your seat belt clean.
- Do not jam or damage the seat belt or rub it with sharp edges.
- Make sure there are no liquids or foreign bodies on the latch plate and in the buckle.

Fastening or unfastening a seat belt with one buckle

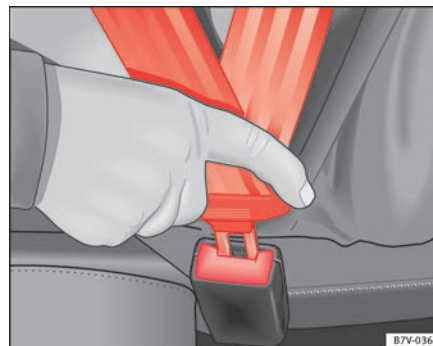

Fig. 10 Insert the latch plate into the buckle.





Fig. 11 Release the latch plate from the buckle.

Properly worn seat belts hold the vehicle occupants in the position that most protects them in the event of an accident or sudden braking ⇒ ⚠️ ▶️

Fastening the seat belt

Fasten your seat belt before each trip.

- Adjust the front seat and head restraint correctly ⇒ page 10.
- Engage the backrest of the rear seat in an upright position ⇒ .
- Pull the latch plate and place the belt webbing evenly across your chest and lap. Do **not** twist the seat belt when doing so ⇒ .
- Engage the latch plate in the buckle of the corresponding seat ⇒ fig. 10.
- Pull the belt to ensure that the latch plate is securely engaged in the buckle.

Unfastening the seat belt

The seat belt must not be unfastened until the vehicle has come to a standstill ⇒ .

- Press the red button on the buckle ⇒ fig. 11. The latch plate is released from the buckle.
- Guide the belt back by hand so that it rolls up easily and the trim will not be damaged.



WARNING

An incorrectly worn seat belt web can cause severe or fatal injuries in the event of an accident.

- The seat belt cannot offer its full protection unless the backrests are in an upright position and the seat belt is worn correctly, according to your size.
- Unbuckling your seat belt while the vehicle is in motion can cause severe or fatal injuries in the event of an accident or sudden braking.

Fastening or unfastening the seat belt with two buckles

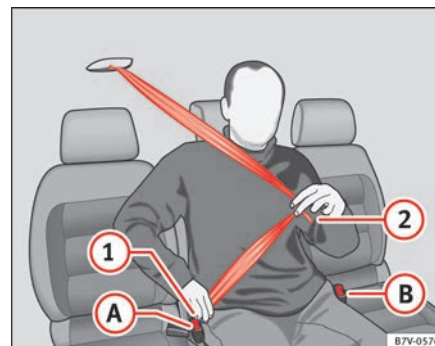











Fig. 12 Fasten the seat belt on the centre seat in the second row of seats.

Properly worn seat belts hold the vehicle occupants in the position that most protects them in the event of an accident or sudden braking ⇒ .

The seat belts for the centre seat in the second row of seats and for the seats in the third row of seats are fastened using two buckles.

Fastening the seat belt

Fasten your seat belt before each trip.

- Adjust the rear seat and head restraint correctly ⇒ page 10.
- Engage the backrest of the rear seat in an upright position ⇒ .
- Use latch plate of the belt ⇒ fig. 12  to pull the seat belt down. Do **not** twist the seat belt when doing so ⇒ .
- Engage the latch plate  in the buckle of the corresponding seat .
- Use the latch plate  to pull the seat belt across your lap.
- Engage the latch plate  in the buckle of the corresponding seat .
- Pull the belt to ensure that **both** latch plates are securely engaged in the buckles.

Unfastening the seat belt

The seat belt must not be unfastened until the vehicle has come to a standstill ⇒ ⚠.

- Press the red button on the buckle (A). The latch plate is released from the buckle.
- Press the red button on the buckle (B). The latch plate is released from the buckle.
- Guide the belt back by hand so that it rolls up easily and the trim will not be damaged.

⚠ WARNING

An incorrectly worn seat belt web can cause severe or fatal injuries in the event of an accident.

- The seat belt cannot offer its full protection unless the backrests are in an upright position and the seat belt is worn correctly, according to your size.
- Unbuckling your seat belt while the vehicle is in motion can cause severe or fatal injuries in the event of an accident or sudden braking.

i Note

Seat belts with two buckles include a diagram to show how to fasten the seat belt.

Seat belt position

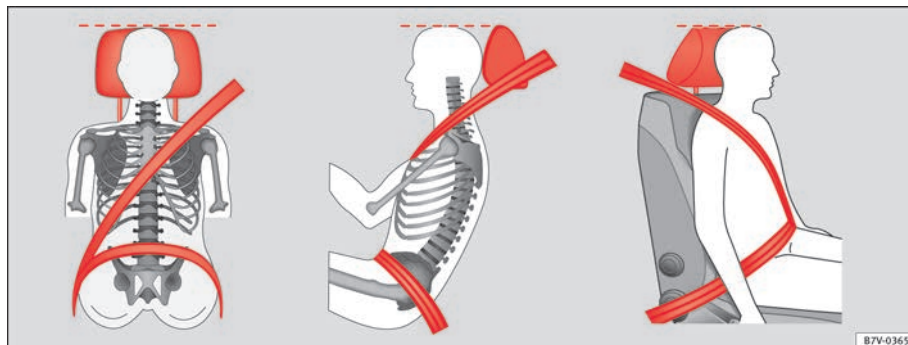

Fig. 13 Correct belt web and head restraint positions. ►



Fig. 14 Correct positioning of seat belts during pregnancy.

Seat belts offer their maximum protection in the event of an accident and reduce the risk of sustaining severe or fatal injuries only when they are properly positioned. Furthermore, if the webbing is correctly positioned, the seat belt will hold the occupants in the optimum position to ensure the air-bag provides the utmost protection. The seat belt must therefore always be worn and the webbing correctly positioned.

Incorrectly worn seat belts can cause severe or even fatal injuries
 ⇒ page 10, Adjusting the seat position.

Correct seat belt position

- The shoulder part of the seat belt must lie on the centre of the shoulder, never across the neck or the arm, under the arm or behind the shoulder.
- The lap part of the seat belt must lie across the pelvis, never across the stomach.
- The seat belt must lie flat and fit comfortably. Pull the belt tight if necessary to take up any slack.

In the case of **pregnant women**, the seat belt must lie evenly across the chest and as low as possible over the pelvis, never across the stomach and must be worn properly at all times during the pregnancy ⇒ fig. 14.

Adapting the position of the belt webbing to your size

The seat belt can be adapted using the following equipment:

- Belt height adjustment for the front seats.
- Seat height adjustment (front seats).



WARNING

An incorrectly worn seat belt web can cause severe injuries in the event of an accident or sudden braking or manoeuvre.

- The seat belt cannot provide optimum protection if it is not correctly worn and the backrest is not tilted slightly backwards.
- The seat belt itself or a loose seat belt can cause severe injuries if the belt moves from hard areas of the body to soft areas (e.g. the stomach).
- The shoulder part of the seat belt must lie on the centre of the shoulder, never across the neck or the arm.
- The seat belt must lie flat and fit comfortably on the torso
- The lap part of the seat belt must lie across the pelvis, never across the stomach. The seat belt must lie flat and fit comfortably on the pelvis. Pull the belt tight if necessary to take up any slack.
- For pregnant women, the lap part of the seat belt must lie as low as possible over the pelvis and always lie flat, “surrounding” the stomach.
- Do not twist the seat belt while it is fastened.
- Never pull the seat belt away from your body using your hand.
- Do not lie the seat belt across rigid or fragile objects, e.g. glasses, pens or keys.
- Never use seat belt clips, retaining rings or similar instruments to alter the position of the belt webbing.



Note

If your physical constitution prevents you from maintaining the correct position of the belt webbing, contact a Technical Service for help with any special devices to ensure the optimum protection of the seat belt and airbag. SEAT recommends visiting a Technical Service.

Belt height adjustment

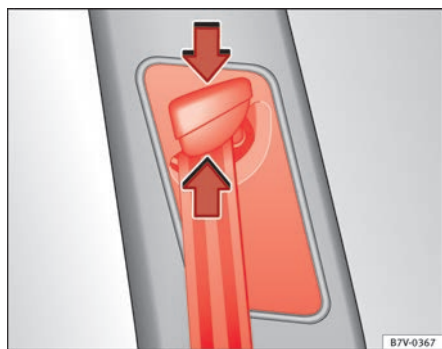

Fig. 15 Next to the front seats: belt height adjuster.

Using the height adjusters for the front seats and the outer seats of the second row, the position of the seat belts can be adjusted in the shoulder area according to the height of the occupant:

- Keep the guide device pressed down in the direction of the arrow ⇒ fig. 15.
- Move the guide device up or down until the seat belt lies over the centre of your shoulder ⇒ page 24, Seat belt position.
- Release the guide device.
- Pull the belt sharply to check that the device is engaged securely.



WARNING

Never adjust the belt height while the vehicle is in motion.

Seat belt tensioners

Automatic belt retainer, belt tension device, belt tension limiter

Seat belts are part of the vehicle safety concept ⇒ page 31 and consist of the following important functions:

Automatic belt retainer

Every seat belt is equipped with an automatic belt retainer on the shoulder belt. If the belt is pulled slowly or during normal driving, the system allows for total freedom of movement on the shoulder belt. However, during sudden braking, during travel in mountains or bends and during acceleration, the automatic belt retainer on the seat belt is locked and pulled quickly.

Belt tension devices

The seat belts on the front seats and the outer seats of the second row are equipped with belt tension devices.

Sensors will trigger the belt tension devices during severe head-on, lateral and rear collisions and retract and tighten the seat belts. If the seat belt is loose, it is retracted to reduce the forwards movement of occupants or movement in the direction of the collision. The belt tension device works in combination with the airbag system. The belt tension device will not be triggered in the event of the vehicle overturning if the side airbags are not deployed.

If the belt tension device is triggered, a fine dust is produced. This is normal and it is not an indication of fire in the vehicle.

Belt tension limiter

The belt tension limiter reduces the force of the seat belt on the body in the event of an accident.



Note

The relevant safety requirements must be observed when the vehicle or components of the system are scrapped. These requirements are known to specialised workshops ⇒ page 27.



For the sake of the environment

Airbag modules and belt tension devices may contain perchlorate. Observe the legal requirements for their disposal.

Service and disposal of belt tension devices

If you work on the belt tension devices or remove and install other parts of the vehicle when performing other repair work, the seat belt may be damaged. The consequence may be that, in the event of an accident, the belt tension devices function incorrectly or not at all.

So that the effectiveness of the belt tension device is not reduced and that removed parts do not cause any injuries or environmental pollution, regulations must be observed. These requirements are known to qualified dealerships.



WARNING

Improper handling and homemade repairs of seat belts, automatic belt retainers and tension devices increase the risk of sustaining severe or fatal injuries. The belt tension device may fail to trigger or may trigger in the wrong circumstances.

- Never attempt to repair, adjust or remove or install parts of the belt tension devices or seat belts. Any work must be performed by a Technical Service only ⇒ page 257.
- Belt tension devices and automatic belt retainers cannot be repaired and must be replaced.

Airbag system

Brief introduction

Introduction

Front airbags have been installed for both driver and passenger. The front airbags can also protect the chest and head of driver and passenger if the seats, seat belts head restraints and, for the driver, the steering wheel are correctly adjusted and used. Airbags are considered as additional safety equipment. An airbag cannot replace the safety belt, which must be worn at all times, even in front seats where front airbags have been installed.

Additional information and warnings:

- Driving tips ⇒ page 7
- Correct sitting positions ⇒ page 10
- Seat belts ⇒ page 21
- Child seats (accessories) ⇒ page 39
- Care and cleaning of the vehicle interior ⇒ page 249
- Accessories, parts replacement, repairs and modifications ⇒ page 257
- Notes for the user ⇒ page 255

WARNING

Never exclusively trust the airbag system as a means of protection.

- Even when triggered, airbag protection is only auxiliary.

WARNING (Continued)

- The airbags provide the best protection when the seat belts are properly fastened, thus reducing the risk of sustaining injuries ⇒ page 21, Seat belts.
- Before each trip, every occupant must sit properly, correctly fasten the seat belt belonging to his or her seat and keeping it fastened throughout the trip. This rule is valid for all occupants.

WARNING

Occupants sitting in the front of the vehicle must never carry any objects in the deployment space between them and the airbags, as this increases the risk of sustaining injuries if the airbag is triggered. This modifies the airbag deployment space or the objects may fly uncontrollably and hit your body.

- Never carry objects in your hand or on your lap while the vehicle is in motion.
- Never transport objects on the front passenger seat. In the event of sudden braking and manoeuvres, the objects may end up in the airbag deployment space and fly uncontrollably around the vehicle interior if the airbag is activated.
- Occupants of the front and outer rear seats must never carry any other people, pets or objects in the deployment space between them and the airbags. Make sure children and other passengers also respect this recommendation.

 **WARNING**

The airbag system provides protection for one accident only. If they have been deployed, they must be replaced.

- Ensure deployed airbags and the system components involved are immediately replaced with new, SEAT-approved components for the vehicle.
- Have any repairs or modifications carried out at a Technical Service. Qualified workshops have the necessary tools, diagnostics equipment, repair information and qualified personnel.
- Never fit recycled or reused airbag components in your vehicle.
- Never modify the airbag system components.

 **WARNING**

If the airbags are triggered, a fine dust is produced. This is normal and it is not an indication of fire in the vehicle.

- This fine dust may irritate the skin and eyes and cause breathing difficulties, particularly in people suffering from or who have suffered from asthma or other illnesses of the respiratory tract. To reduce breathing difficulties, get out of the vehicle and open doors and windows to breath in fresh air.
- Should you touch the dust, wash your hands and face using a mild soap and water before you eat.
- Prevent the dust from affecting the eyes or open wounds.
- Rinse your eyes with water if you have dust in them.

 **WARNING**



Solvents cause the surfaces of the airbag modules to become porous. If an airbag is accidentally triggered, the detachment of plastic parts could cause serious injury.

- Never clean the instrument panel and the surfaces of the airbag modules with cleaners containing solvents.



Warning lamp



Fig. 16 Warning lamp for disabling the front passenger airbag on the instrument panel.

lights up	Digit	Possible cause	Solution
	Instrument panel	Fault in airbag system and seat belt tensioners.	Have the system checked immediately by a specialist workshop.
OFF 	Dash panel	Fault in the airbag system.	Have the system checked immediately by a specialist workshop.
		Front passenger airbag disabled.	Check whether the airbag should remain disabled.

Several warning and control lamps should light up for a few seconds when the ignition is switched. This signals that the lamp is working properly. They will switch off after a few seconds.

If the **PASSENGER AIR BAG OFF**  warning lamp **does not remain lit** or if it is lit together with the control lamp  on the instrument panel and the front passenger airbag is disabled, there may be a fault in the airbag system ⇒ .

WARNING

In the event of a fault in the airbag system, the airbag may not trigger correctly, may fail to trigger or may even trigger unexpectedly, leading to severe or fatal injuries.

- **Have the airbag system checked immediately by a specialist workshop.**
- **Never mount a child seat in the front passenger seat or remove the mounted child seat! The front passenger airbag may deploy during an accident in spite of the fault.**

**CAUTION**

Always pay attention to any lit lamps and to the corresponding descriptions and instructions to avoid damage to the vehicle. ■

Airbag system

Description and function of the airbag

The airbag can protect vehicle occupants in the event of an accidents, cushioning the movement of the occupants in the direction of the collision in frontal and side accidents.

Deployed airbags fill with a propellant gas. This causes the airbag covers to break and the airbags to deploy extremely quickly in their entire deployment space within fractions of a second. When an occupant with the seat belt properly fastened puts pressure on the inflated airbag, the propellant gas escapes to absorb the force of the impact and slow the movement. This reduces the risk of severe or fatal injuries. Airbag deployment does not mean that other types of injury such as swelling, bruising, burns and skin injuries can be ruled out.

Airbags do not protect the arms or the lower part of the body.

The most important factors for triggering the airbag are the type of accident, the angle of impact, the vehicle speed and the characteristics of the object the vehicle hits. Therefore, airbags are not triggered every time the vehicle is visibly damaged.



The airbag system is designed to be triggered in collisions with a severe impact. The front, curtain, side and knee airbags may be triggered under special circumstances. The scope of any visible damage to the vehicle is not an indication of airbag deployment.

Airbags act in conjunction with three-point seat belts in the event of certain accidents, when the vehicle deceleration rate is severe enough to trigger the airbags. Airbags only deploy once and only under certain circumstances. Seat belts remain present to offer protection in situations where airbags are not triggered or where they have already deployed. For example, when a vehicle hits another after an initial collision or is hit by another vehicle.

The airbag system is an integral part of the car's passive safety system. The airbag system can only work effectively when the occupants are wearing their seat belts correctly and have adjusted the head restraints properly  ⇒ page 10.

Vehicle safety components

The following safety equipment makes up the vehicle safety design to reduce the risk of severe and fatal injuries. Depending on the vehicle equipment, some equipment may not be fitted in the vehicle or may not be available in some markets.

- Optimised seat belts for all seats.
- Belt tension devices for the driver and front passenger and, where applicable, on the outer seats of the second row of seats in combination with the side airbags.
- Furthermore, belt tension limiters for the driver's and front passenger's seat belt.
- Belt height adjustment for the front seats and, where applicable, the outer seats of the second row of seats.
- Seat belt warning lamp
- Frontal airbags for driver and passenger.
- Side airbags for the driver, front passenger and, where applicable, the outer seats of the second row of seats.
- Left and right curtain airbags.
- One airbag for the driver's knees.
- Airbag control lamp .
- PASSENGER AIR BAG OFF  control lamp. ▶

- Control units and sensors.
- Height-adjustable head restraint optimised for rear collisions.
- Adjustable steering column.
- Where applicable, mountings for child seats on the rear seats and on the front passenger's seat.
- Where applicable, mountings for the child seat upper retaining strap.

Situations in which the frontal, knee, side and curtain airbag does not deploy:

- If the ignition is switched off during the collision.
- In frontal collisions when the deceleration measured by the control unit is too low.
- In minor side collisions.
- In rear collisions.
- In the event of the vehicle overturning.
- When the impact speed is lower than the reference value set in the control unit. ■

Front airbags

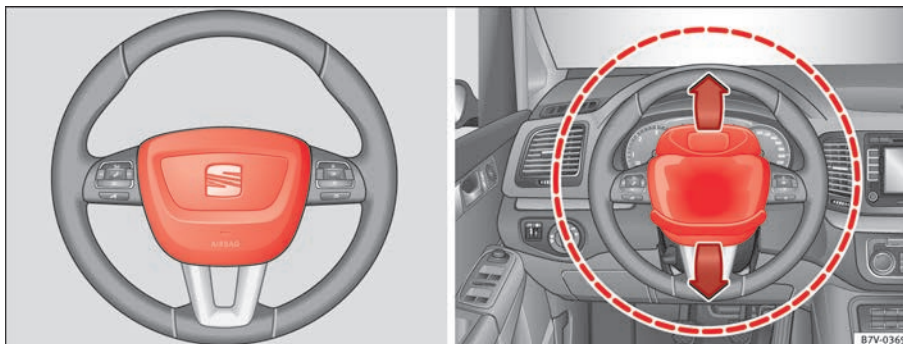

Fig. 17 Location and deployment area of the front airbag for the driver.

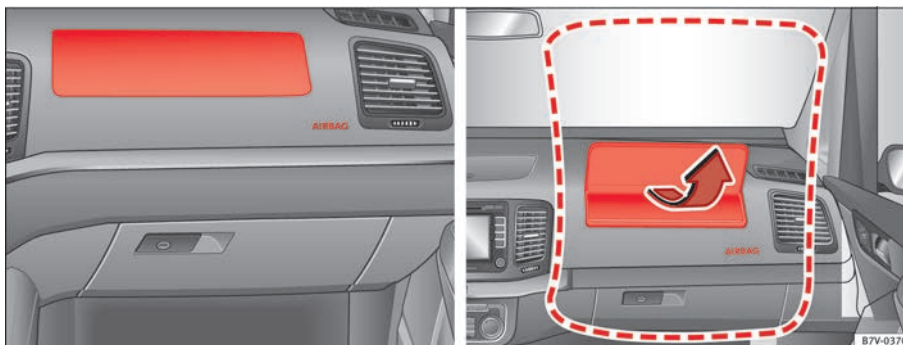

Fig. 18 Location and deployment area of the front airbag for the front passenger.

In conjunction with the seat belts, the front airbag system gives the front occupants additional protection for the head and chest in the event of a severe frontal collision. Always remains as far away as possible from the front

airbag. This way, the front airbags can completely deploy when triggered, providing their maximum protection. ▶

The front airbag for the driver is located in the steering wheel ⇒ fig. 17 and the airbag for the front passenger is located in the dash panel ⇒ fig. 18. Airbags are identified by the word “AIRBAG”.

When the front airbags are triggered they fill the zones marked in red (deployment area) ⇒ fig. 17. Therefore, objects should never be placed or mounted in these areas ⇒ ⚠, Factory-fitted accessories are outside the range of the front airbag for the driver and the front passenger, e.g. the baseplate for the mobile phone support.

The airbag covers fold out of the steering wheel or dash panel when the driver and front passenger airbags are triggered ⇒ fig. 18. The airbag covers remain connected to the steering wheel or the dash panel.

WARNING

The airbag is deployed at high speed in fractions of a second.

- Always keep the deployment areas of the front airbags free.
- Never secure objects to the covers or in the deployment area of the airbag modules, e.g. cup holders or phone supports.
- The deployment space between the front passengers and the airbags must not in any case be occupied by other passenger, pets and objects.
- Never fix any object to the windscreen above the front airbag on the front passenger side.
- Do not alter, cover or stick anything to the steering wheel hub or the surface of the airbag module on the passenger side of the dash panel.

WARNING

Front airbags are deployed in front of the steering wheel ⇒ fig. 17 and the dash panel ⇒ fig. 18.



- When driving, always hold the steering wheel on the outer edge of the ring with both hands: 9 o'clock and 3 o'clock position.

WARNING (Continued)

- Adjust the driver seat so that there is at least 25 cm distance between your chest and the hub of the steering wheel. If your physical constitution prevents you from meeting these requirements, make sure you contact a specialist workshop.
- Adjust the front passenger's seat so there is as much distance as possible between the front passenger and the dash panel.

Types of front passenger airbag systems

There are two different SEAT front passenger airbag systems:

A	B
Characteristics of the front passenger airbag that can only be disabled in a specialist workshop.	Characteristics of the front passenger airbag that can be disabled manually ⇒ page 35.
▶ Name: airbag system	▶ Name: airbag system with front passenger airbag disabling.
▶ Warning lamp  on the instrument panel.	▶ Warning lamp  on the instrument panel.
▶ Front passenger airbag located in the dash panel.	▶ Front passenger airbag located in the dash panel.
	▶ PASSENGER AIR BAG OFF  ; warning lamp on the instrument panel.
	▶ Key switch in the glove compartment on the front passenger side of the dash panel.

Deactivating and activating the front passenger airbag using the key switch



Fig. 19 In the glove compartment on the front passenger side: key switch for disabling and enabling the front passenger airbag.

The front passenger airbag must be disabled when a rear-facing child seat is mounted.

Deactivating the front passenger airbag

- Switch the ignition off.
- Open the glove compartment on the front passenger side.
- Unfold the key shaft ⇒ page 71.
- Using the vehicle key, turn the key switch to **OFF** ⇒ fig. 19.
- Close the glove compartment on the front passenger side.
- The **PASSENGER AIR BAG OFF** ⚠ control lamp on the instrument panel will remain lit while the ignition is switched on ⇒ page 30.

Activating the front passenger airbag

- Switch the ignition off.
- Open the glove compartment on the front passenger side.
- Using the vehicle key, turn the key switch to **ON** ⇒ fig. 19.

- Close the glove compartment on the front passenger side.
- Check that the **PASSENGER AIR BAG OFF** ⚠ control lamp on the instrument panel does *not* light up while the ignition is switched on ⇒ page 30.

How to know whether the front passenger airbag is disabled

Disabling of the front passenger airbag is **only** indicated by the **PASSENGER AIR BAG OFF** ⚠ control lamp that remains lit on the instrument panel (**OFF** ⚠ remains yellow) ⇒ page 30, Warning lamp.

If the **PASSENGER AIR BAG OFF** ⚠ control lamp on the centre console **does not remain lit** or is lit in combination with the control lamp ⚠ on the instrument panel, a child restraint system cannot be mounted on the front passenger's seat for safety reasons. The front passenger airbag may deploy during an accident.



WARNING

The front passenger airbag must only be disconnected in special cases.

- **Disconnect and connect the front passenger airbag when the ignition is switched off to avoid damage to the airbag system.**
- **It is the driver's responsibility to ensure that the key operated switch is set to the correct position.**
- **Only disconnect the front passenger airbag when a child seat is to be mounted under exceptional circumstances.**
- **As soon as the child seat is no longer needed on the front passenger's seat, reconnect the front passenger airbag.**

Side airbags

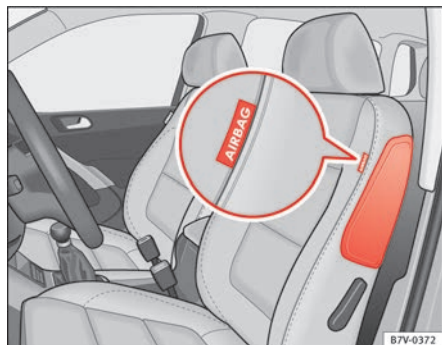

Fig. 20 On the side of the front seat: location of the side airbag.

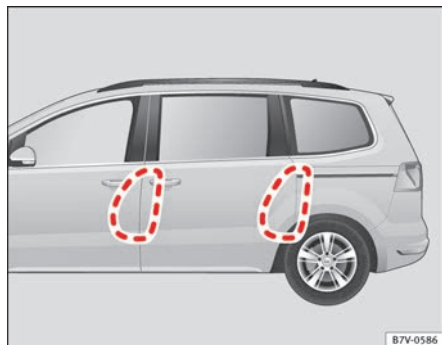

Fig. 21 Range of action of the front and rear side airbags. With 5 and 7 seats.

The side airbags are located in the outer cushion of the driver and front passenger seat backrests ⇒ fig. 20. Depending on the equipment of the model, the outer seats of the second row of seats may also be fitted with side air-

bags, located between the seat backrests and the access area. Their position is indicated by the word "AIRBAG". The red area (dotted line) ⇒ fig. 21 shows the field of action of the side airbags.

In a side collision, the side airbags are triggered on the affected side of the vehicle, thus reducing the risk of injury to passengers on that side.

WARNING

The airbag is deployed at high speed in fractions of a second.

- Always keep the deployment areas of the side airbags free.
- Occupants of the front and outer rear seats must never carry any other people, pets or objects in the deployment space between them and the airbags.
- The built-in coat hooks should be used only for lightweight clothing. Do not leave any heavy or sharp-edged objects in the pockets.
- Do not mount accessories on the doors.
- Only used protective covers for the seats that are approved for the vehicle. Otherwise, the side airbag would be obstructed when deployed.

WARNING

Incorrect handling of the driver's and front passenger's seat could prevent the side airbag from deploying properly and cause severe injuries.

- Never remove the front seats of the vehicle or modify any of their components.
- Great forces must not be exerted on the backrest bolsters because the side airbags might not deploy correctly, might not deploy at all or might deploy unexpectedly.
- Any damage to the original seat upholstery or around the seams of the side airbag units must be repaired immediately by a specialised workshop.

Curtain airbags

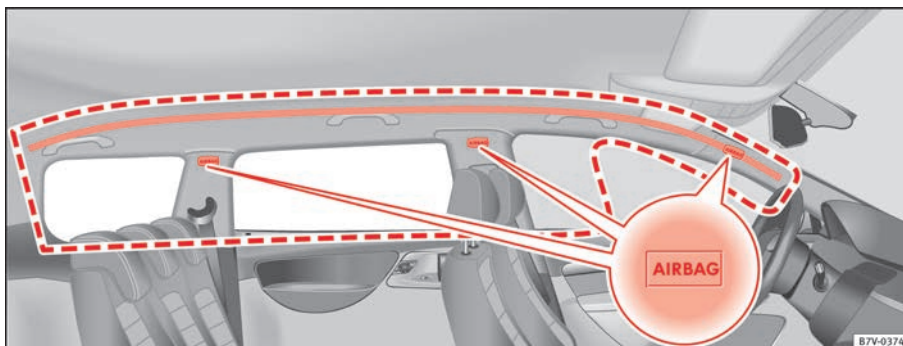

Fig. 22 On the left side of the vehicle: location and deployment area of the curtain airbag.



Fig. 23 Deployed curtain airbags

The curtain airbags are located on the driver and front passenger side above the doors ⇒ fig. 22. Airbags are identified by the word “AIRBAG”.

The area framed red ⇒ fig. 22 is covered by the curtain airbag when it is deployed (deployment area). Therefore, objects should never be placed or mounted in these areas.

In a side collision, the curtain airbag on the side affected will be deployed. The airbag covers the windows and pillars.

In a side collision, the curtain airbags for the front and outer rear seats reduce the risk of injury to the areas of the body facing the impact.

WARNING

The airbag is deployed at high speed in fractions of a second.

- Always keep the deployment areas of the curtain airbags free.
- Do not fix objects to the cover or in the deployment area of the curtain airbag.

⚠ WARNING (Continued)

- Occupants of the front and outer rear seats must never carry any other people, pets or objects in the deployment space between them and the airbags.
- The built-in coat hooks should be used only for lightweight clothing. Do not leave any heavy or sharp-edged objects in the pockets.
- Do not mount accessories on the doors.
- Do not fit curtains to the windows other than those expressly approved for use in the vehicle.
- Only turn the sun blinds towards the windows if there is no object, e.g. pens or garage remote controls, secured to the sun blind.

Knee airbag

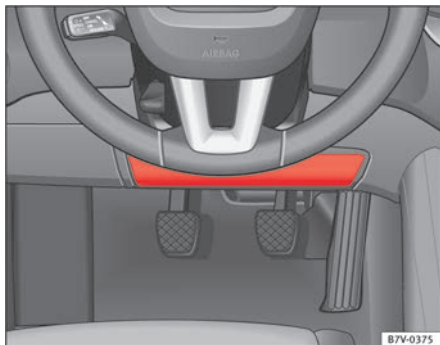

Fig. 24 On the driver side: location of the knee airbag.

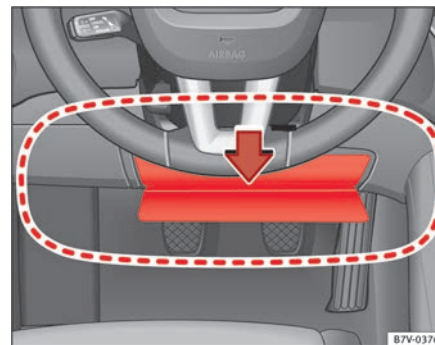

Fig. 25 On the driver side: Radius of action of the knee airbag.

The knee airbag is located on the driver side below the instrument panel ⇒ fig. 24. Airbags are identified by the word “AIRBAG”.

The area framed red ⇒ fig. 25 **A** is covered by the knee airbag when it is deployed (deployment area). Therefore, objects should never be placed or mounted in these areas.

⚠ WARNING

The airbag is deployed at high speed in fractions of a second.

- The knee airbag is deployed in front of the driver's knees. Always keep the deployment areas of the knee airbags free.
- Never not fix objects to the cover or in the deployment area of the knee airbag.
- Adjust the driver's seat so that there is a distance of at least 10 cm (4 inches) between your knees and the location of the knee airbag. If your physical constitution prevents you from meeting these requirements, make sure you contact a specialist workshop.

Child safety

Child seats (accessories)

Introduction

Please read the information regarding the airbag system fully before transporting babies and children in a child seat or other child restraint system installed on the front passenger seat.

This information is extremely important for driver and passenger safety, particularly that of babies and children.

SEAT recommends the use of child seats from the SEAT accessory programme. These child seats have been designed and tested for use in SEAT vehicles. You can purchase child seats with different mountings from a Technical Service.

Using child restraint systems with a base or foot

Some child retention systems are secured to the seat using a base or foot. For certain equipment the use of an additional accessory will be necessary (for example, the accessory for the floor compartment) to fit the child retention system correctly and securely.

Additional information and warnings:

- Airbag system ⇒ page 31
- Integrated child seats ⇒ page 45



WARNING

Make sure children are properly belted in and correctly secured to avoid severe or fatal injuries while the vehicle is in motion.

- Never use a rear-facing child seat in the front passenger seat if the front passenger airbag is enabled.
- Children up to 12 years old should always travel on the rear seat.
- Children must always be protected with an approved child restraint system suited to their height and weight.
- Children must assume the proper sitting position and be properly belted in while travelling.
- Ensure the backrest of a seat is upright when a child seat is being used on it.
- Do not allow the child's head or other part of his or her body to fall into the deployment area of the side airbags.
- Make sure the belt webbing is correctly positioned.
- Never hold children or babies on your lap or in your arms.
- Only one child may occupy a child seat.
- If you are using a child seat with a base or foot, always install this base or foot correctly and safely.
- If the vehicle has a storage compartment in the foot well in front of the last row of seats, this compartment cannot be used as designed; on the contrary: It must be filled using the specially designed accessory so that the base or foot is correctly supported by the closed compartment and the child seat is secured properly. If this compartment is not suitably secured when using a child seat with a base or foot then the compartment cover could rupture in an accident and the child will be ejected and suffer serious injury.
- Please read and observe the child seat manufacturer's handling instructions.

 **WARNING**

An empty or loose child seat could fly uncontrollably around the vehicle interior and cause injuries in the event of an accident or sudden braking.

- **When not in use while the vehicle is in motion, always safely secure it or store it in the luggage compartment.**

**Note**

Replace the child seat after an accident, as it may have invisible damage. ■

General information on transporting children in the vehicle

Legal regulations and provisions will always take priority over the descriptions of this instruction manual. There are different regulations and provisions for the use of child seats and their mountings (⇒ table on page 41). In some countries, for example, the use of child seats on certain seats in the vehicle may be forbidden.

The physical principles and the forces acting on the vehicle in the event of a collision or other type of accidents also apply to children ⇒ page 21. However, unlike adults and youngsters, children do not have fully developed muscle and bone structures. In the event of an accident, children are subject to a greater risk than adults of sustaining severe injuries.

Given that children's bodies are not yet fully developed, child restraint systems must be used that are especially adapted to their height, weight and constitution. There are laws in force in many countries that determine the use of approved seat systems for transporting babies and children.

Only used authorised, approved child seats that are suitable for the vehicle. Always consult with a SEAT qualified workshop or a specialist workshop should you have any doubts.

Checklist

To transport children in the vehicle ⇒ :

- Observe the legal requirements specific to each country.
- For safety reasons, SEAT recommends that children under 12 years of age are transported on the rear seats.
- Only if you have no alternative should a child travel on the front passenger seat ⇒ page 42. The safest place in the vehicle is on the rear seat behind the front passenger seat.
- Child must always use a child restraint system when travelling in the vehicle. The child restraint system must be suitable for the height, weight and constitution of the child.
- Only one child may occupy a child seat.
- Follow the user instructions from the child seat manufacturer and always keep them in the vehicle.
- If the child seat is secured using the seat belt, guide the seat belt through or around the child seat according to the instructions of the child seat manufacturer.
- Make sure the belt webbing is correctly positioned and that the child is sitting properly.
- The child seat should be installed on the rear seat behind the front passenger seat so that the child can exit the car on the kerb side.
- Do not leave toys or other loose objects on the child seat or on the seat while the vehicle is in motion.

Specific child seat regulations for each country (selection)

Regulation	Further information
ECE-R 44 ^{a)}	Technical Service or qualified workshop

^{a)} ECE-R: Economic Commission for Europe Regulation. ►

Categorisation of child seats according to ECE-R 44

Weight category	Weight of the child	Installation of the child seat
Group 0	children up to 10 kg	Rear-facing. On rear seats, optionally using the ISOFIX system.
Group 0+	children up to 13 kg	
Group 1	9 to 18 kg	Forward-facing. On rear seats, optionally using the ISOFIX system.
Group 2	15 to 25 kg	Forward-facing. On the outer rear seats or in the centre seat of the second row of seats and on all seats in the third row. Optionally with ISOFIX system.
Group 3	22 to 36 kg	Forward-facing.

Not all children fit in the seat of their weight group. Nor do all seats adapt to the vehicle. Therefore, always check whether the child fits properly in the child seat and whether the seat can be installed safely in the vehicle.

The rear seats are suitable for child seats with the **ISOFIX system** specially designed for this type of vehicle in accordance with regulation ECE-R 44.

Child seats approved under the ECE-R 44 regulation are fitted with the corresponding approval symbol. The sign is an upper-case E in a circle with the identification number below it.

WARNING

Not following the checklist prepared for your own safety could lead to accidents and severe injuries.

- Always follow the check list and perform the necessary operations.

WARNING

In general, the rear seat is always the safest place for correctly belted in children in the event of an accident.

- A suitable child seat that is correctly installed and used on one of the rear seats offer the most protection possible for babies and small children in most accidents.

Note

Other accessories may be required to fit the child retention system with a base or foot security and safety. Contact a specialist or qualified workshop. ■

Different mounting systems

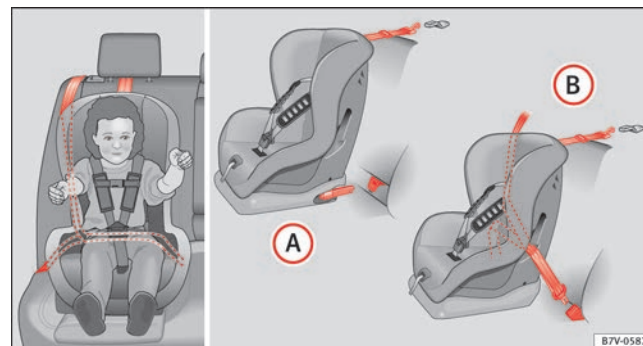

Fig. 26 On the rear seats: figure (A) shows the basic child restraint system mounting using lower retaining rings and the upper retaining strap. Figure (B) shows the child restraint system mounting using the vehicle's seat belt. ▶

Always secure child seats properly and safely in the vehicle according to the child seat manufacturer's installation instructions.

Mounted child seats must rest correctly on the vehicle's seat and must not move or rock more than 2.5 cm (1 inch).

Child seats equipped for a Top Tether strap must also be secured using the Top Tether retaining strap in the vehicle ⇒ page 45. Only secure the retaining belt to the rings fitted for this purpose and identified as Top Tether. Not all rings can be used with the Top Tether system. Always tighten the Top Tether retaining strap so that the child seat fits snugly against the corresponding seat in the vehicle.

Specific mounting systems for each country

- (A)** Europe: ISOFIX retaining rings and upper retaining strap ⇒ page 44 and ⇒ page 45.
- (B)** Three-point seat belt and upper retaining strap ⇒ page 44.



The systems include the child restraint system mounting with an upper retaining strap (Top Tether) and lower anchoring points on the seat. ■

Use of the child seat on the front passenger seat

Transporting children on the front passenger seat is not permitted in all countries. Furthermore, not all child seats are approved for use on the front passenger seat. Your SEAT qualified workshop has an updated list of all approved child seats. Only used child seats that are approved for each vehicle.

The frontal airbag on the front passenger side is highly dangerous for a child. The front passenger seat is life-threatening to a child if he or she is transported in a rear-facing child seat.

If a rear-facing child seat is secured to the front passenger seat, an inflating airbag can strike it with such great force that severe or fatal injuries may result ⇒ . Therefore, rear-facing child seats must **never** be used on the front passenger seat when the front passenger airbag is enabled.

Only use a rear-facing child seat on the front passenger seat if the front passenger airbag is disabled. When it is disabled, the yellow **PASSENGER AIR BAG OFF**  control lamp on the instrument panel will be lit ⇒ page 31. **If you cannot disable the front passenger airbag and it remains enabled, it is forbidden to transport children on the front passenger seat ⇒ .**

Things to note if using a child seat on the front passenger seat:

- The front passenger airbag **must** be disabled  if using a rear-facing child seat ⇒ page 35.
- The backrest of the front passenger seat must be upright.
- The front passenger seat must be moved as far back as possible.
- The backrest of the front passenger seat must be upright.
- The seat belt height adjustment must be as high as possible.

Suitable child seats

The child seat must be authorised by the manufacturer especially for use on a front passenger seat with a frontal or side airbag.

If the front passenger seat is equipped with **retaining rings**, the child seat can be secured using the approved retaining system provided it is approved for this type of vehicle in accordance with current regulations in the country in question.

Universal seats for children in groups 0, 0+, 1, 2 or 3 according to the ECE-R 44 regulation.



WARNING

If a child seat is mounted on the front passenger seat, the risk of the child sustaining severe or fatal injuries in the event of an accident increases. Rear-facing child seats must never be mounted on the front passenger seat when the front passenger airbag is enabled. This is life-threatening to the child should the frontal airbag deploy, as the child seat would be struck by the inflated airbag and thrown against the backrest. ►

 **WARNING**

If, in exceptional circumstances, a child must be transported in a rear-facing child seat on the front passenger seat, strictly observe the following:

- Always disable the front passenger airbag and leave it disabled.
- The child seat must be approved by the manufacturer for use on a front passenger seat with frontal and side airbag.
- Follow the installation instructions of the child seat manufacturer and observe the warnings.
- Move the front passenger seat as far back as possible and adjust it to its highest position to keep as far away as possible from the frontal airbag.
- Move the backrest to the upright position.
- The seat belt height adjustment must be as high as possible.
- Children must always be protected with an approved child restraint system suited to their height and weight.

Use of the child seat on the rear seat

If a child seat is mounted on the rear seat, adapt the position of the front passenger seat so that the child has enough space. Therefore, adapt the front passenger seat to the size of the child seat and the height of the child. Ensure the passenger is in the correct position  ⇒ page 10.

Move the second and third row of seats fully back and lock them. Place the seat backs in a vertical position and fold the armrests down.

ISOFIX child seats approved for rear seats

The rear seats are suitable for child seats with the **ISOFIX system** specially designed for this type of vehicle in accordance with regulation ECE-R 44.

ISOFIX child seats are divided into “specific categories for the vehicle”, “limited” or “semi-universal”.

Child seat manufacturers supply a list of vehicles with each ISOFIX seat, which includes the models for which the ISOFIX child seat in question is approved. If the vehicle is included in the manufacturer’s list and the ISOFIX child seat belongs to a seat category included in the list, then it can be used in your vehicle. If necessary, contact the child seat manufacturer for an updated list of vehicles.

Group (weight category)	ISOFIX child seat category	Seat position on the rear seats
Group 0: children up to 10 kg	E	IUF ^{a)}
	E	IUF ^{a)}
Group 0+: children up to 13 kg	D	IUF ^{a)}
	C	IUF ^{a)}
	D	IUF ^{a)}
Group 1: 9 to 18 kg	C	IUF ^{a)}
	B	IUF ^{a)}
	B1	IUF ^{a)}
	A	IUF ^{a)}

a) IUF: suitable for “universal” ISOFIX child seats authorised for use in this group.

 **WARNING**

If child seats are fitted to all the seats in the second row then it is possible that the seats of this row cannot be folded down from the third row of seats in case of an accident. In case of an emergency, passengers in the third row of seats will not be able to leave the vehicle or to help themselves.

- Child seats should not occupy all the seats of the second row if other passengers are to occupy the third row of seats.

Securing child seats with the seat belt

Securing the child seat using the seat belt

- Please read and observe the child seat manufacturer's handling instructions.
- Positioning the child seat on the seat according to the manufacturer's instructions.
- The seat belt height adjustment must be as high as possible.
- Fasten the seat belt or pass it around the child seat structure in the manner described in the manufacturer's instructions.
- Make sure the seat belt is not twisted.
- Insert the latch plate into the buckle for the appropriate seat and push it down until it is securely locked with an audible click.
- Ensure that the upper belt web lies tightly on the child seat.
- Pull the belt (it must be no longer possible to pull the lower belt webbing out).

Removing the child seat

The seat belt must not be unfastened until the vehicle has come to a standstill ⇒ ⚠.

- Press the red button on the buckle. The latch plate is released from the buckle.
- Guide the belt back by hand so that it rolls up easily and the trim will not be damaged.
- Remove the child seat from the vehicle.

WARNING

Unbuckling the seat belt while the vehicle is in motion can cause severe or fatal injuries in the event of an accident or sudden braking.

- **The seat belt must not be unfastened until the vehicle has come to a standstill.**

Securing the child seat using the lower anchor points (ISOFIX, LATCH*)

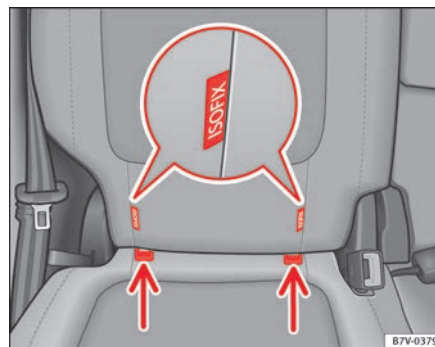

Fig. 27 Version 2: identification of the anchor points for the child seat on the vehicle seat.

There are **two** retaining rings, the so-called lower anchor points, on each rear seat or, where applicable, on the front passenger seat. The retaining rings are attached to the seat frames.

Child seats with rigid mounting

- Observe the manufacturer's instructions when installing and removing the child seat ⇒ ⚠.
- Press the child seat onto the retaining rings ⇒ fig. 27 in the direction of the arrow. The child seat must be safely engaged and click audibly into place.
- Pull on both sides of the child seat to ensure that it is secure.

Child seat with adjustable retaining straps

- Observe the manufacturer's instructions when installing and removing the child seat ⇒ ⚠.
- Place the child seat on the seat cushion and attach the retaining strap hooks to the retaining rings ⇒ fig. 27.

- Tighten the straps evenly using the corresponding adjustment device. The child seat must sit flush against the vehicle seat.
- Pull on both sides of the child seat to ensure that it is secure.

WARNING

The lower anchor points for child seats do not include rings. Only secure booster seats to lower anchor points.

Securing a child seat using a Top Tether retaining strap

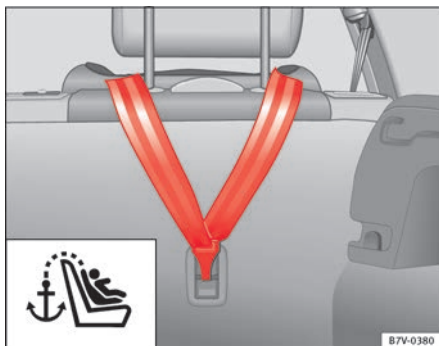



Fig. 28 Upper retaining strap hooked in the luggage compartment

- Observe the manufacturer's instructions when installing and removing the child seat ⇒ .
- Raise the head restraint behind the child seat until it engages.
- Secure the child seat to the lower anchor points ⇒ page 44.
- Pull the upper child seat retaining strap back to the backrest of the rear seat, **below** or on **both sides** of the head restraint (depending on the child seat model).

- Hook the upper retaining strap to the corresponding retaining ring (for TOP TETHER) on the back of the backrest on the rear seat ⇒ fig. 28.
- Push the head restraint down as far as it will go. Ensure that it does not interfere with the seatbelt from the upper attachment.
- Tighten the strap so that the top of the child seat rests on the backrest.

WARNING

Child seats with lower anchor points and with an upper retaining strap must be installed in line with the manufacturer's instructions. Failure to comply could result in severe injuries.

- Always secure just *one* retaining strap from a child seat to a retaining ring (for TOP TETHER) on backrest on the rear seat in the luggage compartment.
- Never secure a child seat to the retaining rings.
- Never secure a child seat to the movable attachment elements for vehicles *with an attachment element and rail system*.

Integrated child seat

Introduction

The integrated child seat is only suitable for children in Group 2 (15-25 kg) and Group 3 (22-36 kg), according to the ECE-R 44 regulation.

Additional information and warnings:

- Seat belts ⇒ page 21

 **WARNING**

Child travelling without their seat belt fastened or not secured using a suitable restraint system may sustain fatal injuries if the airbag is deployed.

- Children up to 12 years old should always travel on the rear seat.
- Always disable the front passenger airbag if, in exceptional cases, you have no alternative but to transport a child in a rear-facing child safety seat on the front passenger seat.
- Children must always be protected with a child restraint system suited to their height and weight.
- Always fasten children's seat belts correctly.

 **WARNING**

Children must travel in a child seat appropriate to their weight and height while the vehicle is in motion.

- Children must always be protected with a child restraint system suited to their height and weight.
- Children must assume the proper sitting position and be properly belted in while travelling.
- The shoulder part of the seat belt must lie approximately on the centre of the shoulder, never across the neck or the arm.
- The seat belt must lie close to the upper part of the body.

 **WARNING (Continued)**

- The lap belt part must lie across the pelvis, not across the stomach, and always fit closely.
- Allow the belt to retract until it fits tightly over the child's seat.
- Never hold children or babies on your lap.
- Always use a child seat and the seat belt for children who are less than 1.5 metres tall. The *normal* seat belt could cause injuries to the abdominal and neck areas.
- Only one child may occupy a child seat.
- Read and follow the information and warnings provided by the child seat manufacturer.
- Never leave an unsupervised child alone on a child seat or in the vehicle.
- All modifications to the integrated child seat must be carried out by a specialist workshop.
- Replace the child seat or any seat components damaged or involved in an accident.

 **WARNING**

Loose objects could fly uncontrollably around the vehicle interior and cause injuries in the event of an accident or sudden braking.

- Do not leave toys or other hard, loose objects on the child seat or on the seat while the vehicle is in motion.

Unfolding the integrated child seat

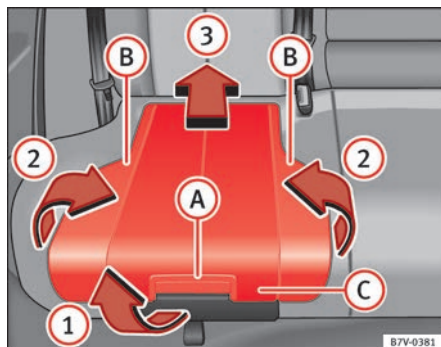

Fig. 29 Integrated child seats. lift up the cushion.

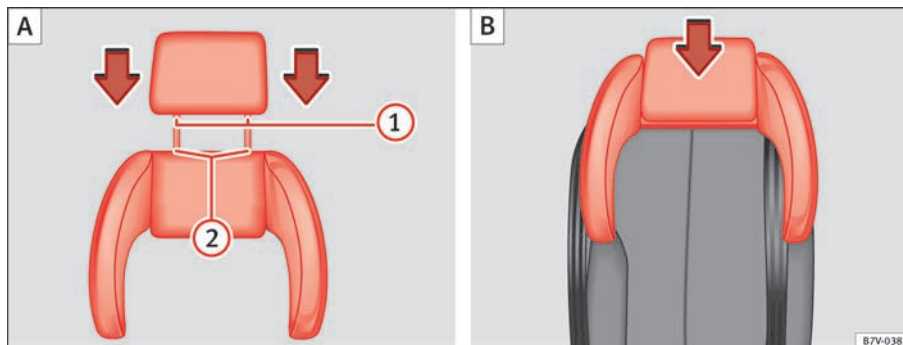

Fig. 30 Integrated child seats. position the head restraint over the side head restraint (A) and fit into place (B).

The integrated child seat can be fitted with a side head restraint. SEAT recommends use of the integrated child seat with the side head restraint fitted and also that this seat be used only for children above the age of 3. ▶

Lifting the cushion

- Pull the unlock lever ⇒ fig. 29 **A** on the cushion in the direction of the arrow **1**.
- Fold both sides **B** up in the direction of the arrow **2**.
- Push the cushion **C** back in the direction of the arrow **3** until it engages.

Fitting the side head restraint

- Fold the backrest of the rear seat forwards ⇒ page 117.
- Remove the head restraint.
- Make sure the belt guide handle on the window side is on the side head restraint ⇒ page 48.
- Insert the guide rods ⇒ fig. 30 **1** of the head restraint into the guides on the side head restraint **2**.
- Insert the head restraint and the side head restraint into the guides on the corresponding backrest **B**.
- Push the head restraint down as far as it will go.
- Fold the backrest of the rear seat back.
- Pull the rear seat and the backrest to check whether they are engaged properly. ■

Seat belt routing on the integrated child seat

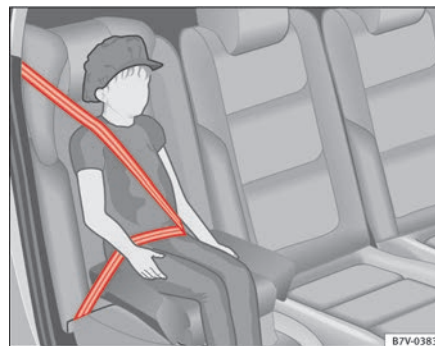

Fig. 31 Integrated child seats. Adjusting the belt webbing.



Fig. 32 Integrated child seats. seat belt routing with guide handle.

Using the guide handle ⇒ fig. 32, position the seat belt so that the shoulder part of the belt lies on the centre of the child's shoulder. ►

Seat belt guide handle

- Secure the seat belt guide handle to the side head restraint on the window side. The guide handle is secured by a button.
- Open the upper button on the seat belt guide handle and pass the belt webbing below the side head restraint and through the guide handle.
- Close the button again.

Adjusting the belt routing

- Guide the automatic three-point seat belt below the side head restraint.
- Pull the latch plate and slowly place the belt webbing across the child's chest and lap.
- Insert the latch plate into the buckle for the appropriate seat and push it down until it is securely locked with an audible click.
- Pull the belt to ensure that the latch plate is securely engaged in the buckle.

WARNING

The seat belt only offers maximum protection from severe or fatal injuries when it is correctly positioned.

- Children must assume the proper sitting position and be properly belted in while travelling.
- The shoulder belt must be positioned against the middle of the shoulder.
- The seat belt must lie flat and fit comfortably.
- Allow the belt to retract until it fits tightly over the child's seat.
- The lap part of the seat belt must lie across the pelvis, never across the stomach.
- Only one child may occupy a child seat.

Removing the seat belt

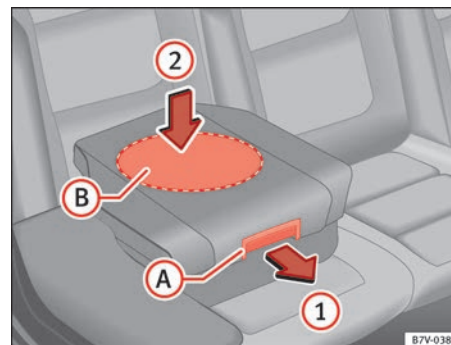

Fig. 33 Integrated child seats, lowering the cushion.

Lowering the cushion

- Pull the unlock lever ⇒ fig. 33 (A) on the cushion in the direction of the arrow ①.
- Push the cushion down through the *central* area (B) in the direction of the arrow ② until it safely engages ⇒ ④. The side supports fold away automatically.

Removing the side head restraint

- Open the seat belt guide handle.
- Guide the seat belt by hand to pull the belt back in more easily and not damage the trim.
- Push the head restraint up as far as it will go.
- Fold the backrest of the rear seat forwards ⇒ page 117.
- Remove the head restraint along with the side head restraint.
- Remove the head restraint and side head restraint by pulling on it.
- Fitting the head restraint.

**CAUTION**

When lowering the integrated child seat, only press on the centre of the cushion ②. Otherwise the cushion could bend and not engage properly. ■

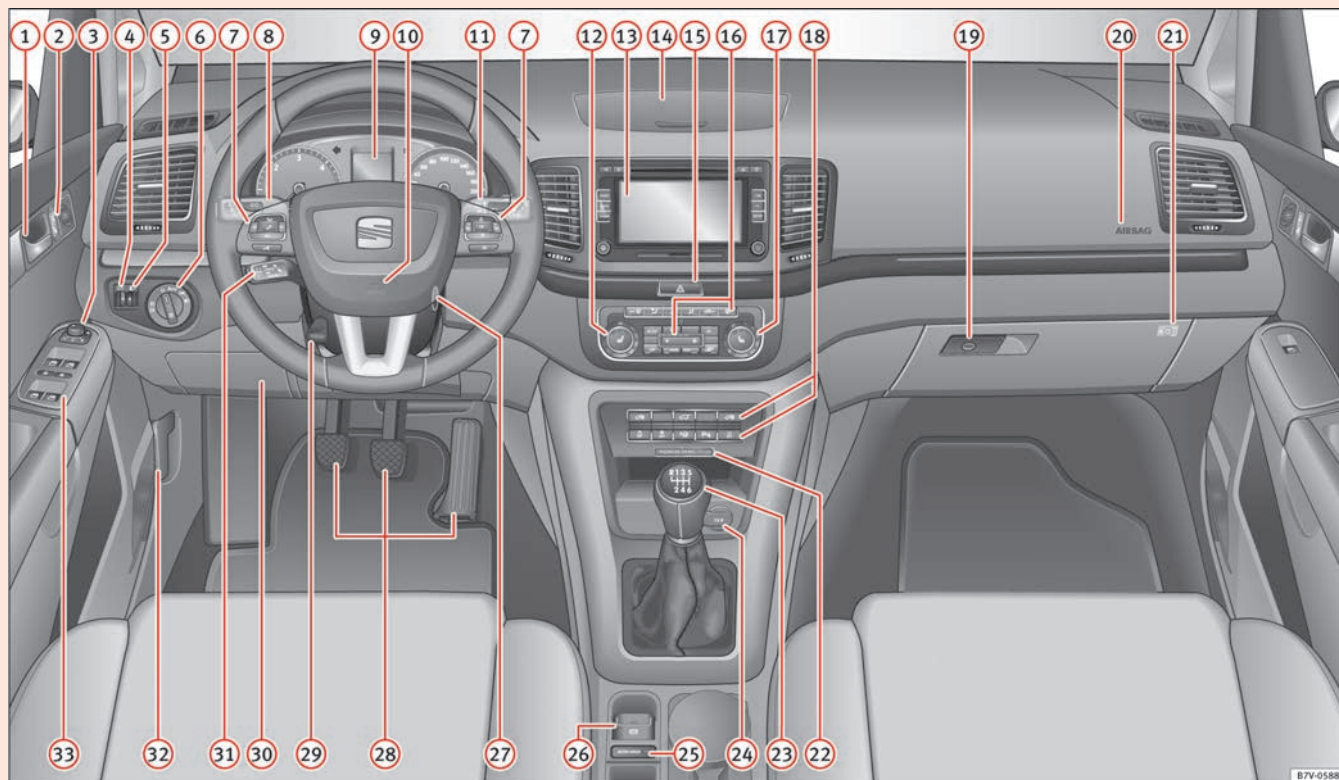

Fig. 34 Dash panel

Operating instructions











Cockpit



Overview

Overview of the dash panel

This overview will help you to familiarise yourself with the controls and displays.

①	Door release lever	80	
②	Central locking button -	74	
③	Switch for adjusting the exterior mirrors	110	
	– Exterior mirror adjustment L - R - 0		
	– Heated exterior mirrors		
	– Folding exterior mirrors		
④	Instrument panel controls and lighting control	95	
⑤	Headlamp range adjustment	95	
⑥	Light switch	95	
	– Light off -0-		
	– Automatic headlight control - AUTO -		
	– Side/dipped lights		
	– Fog lights		
⑦	Controls on the multi-function steering wheel	62	
	– Volume control for radio, navigation system and phone conversations -		
	– Radio mute or voice control activation		
	– Activate telephone main menu or accept an incoming call		
	– SEAT information system control buttons <, >, OK, ↵		
⑧	Lever for	95	
	– Main beam headlights		
	– Headlight flasher		
	– Turn signals		
	– Parking lights		
⑨	Instrument panel:		
	– Instruments	57	
	– Digital display	57	
	– Indicator lamps	54	
⑩	Horn (works only when the ignition is on)/Front driver airbag	31	
⑪	Windscreen wiper/ windscreen wash lever	105	
	– Windscreen wipers HIGH - LOW		
	– Intermittent wipe		
	– “Brief wipe”		
	– Windscreen wipers		
	– Automatic windscreen wash/wipe		
	– Rear window wiper		
	– Automatic rear window wash/wipe		
	– Lever with buttons for controlling the SEAT information system TRIP- , OK/RESET	62	
⑫	Left seat heating controls	117 ▶	

13	Radio or navigation system (fitted at factory) ⇒ Booklet Radio or ⇒ Booklet Navigation system	
14	Storage compartment	141
15	Hazard warning lights switch 	312
16	Switches for:	
	– Climatic	155
	– Climatronic	155
17	Right seat heating controls 	117
18	Button for:	
	– Anti-slip regulation (ASR)  OFF	183
	– Start/stop operation 	194
	– Parking distance warning system (Park Pilot) 	198
	– Park Assist system 	202
	– Tyre pressure monitor  SET	221
	– Opening the tailgate 	84
	– Opening and closing of electric sliding doors 	81
19	Locking lever to open glove compartment	141
20	Position of passenger front airbag on the instrument panel	31
21	Key-operated switch in glove box for deactivating front passenger's airbag	31
22	Passenger front airbag off warning lamp	31
23	Lever for:	
	– Manual gearbox	174
	– Automatic gearbox	174
24	12 Volt socket	151
25	Auto Hold Switch AUTO-HOLD	194
26	Electronic parking brake switch 	183
27	Ignition lock	170
28	Pedals	174
29	Steering column adjustment lever	10

30	Fuse box cover	322
31	Lever for:	
	– Cruise control system (GRA) OFF – CANCEL – ON – RESUME / - SPEED- / -SET	212
32	Open bonnet lever	275
33	Controls for:	
	– Electric windows 	89
	– Childproof locks 	80





Note

- Some of the items of equipment listed here are fitted only on certain model versions or are optional extras.
- In versions with the steering wheel on the right, the layout of the control elements is somewhat different. But the symbols assigned to the controls correspond to the symbols used in the versions with the steering wheel on the left

Instrument panel

Control and warning lamps

The control and warning lamps are indicators of warnings, ⇒ , faults ⇒  or certain functions. Some control and warning lamps come on when the ignition is switched on, and go out when the engine starts running, or while driving.

Depending on the model, additional text messages may be viewed on the instrument panel display. These may be purely informative or they may be advising of the need for action ⇒ page 57, Instruments.

















Depending upon the equipment fitted in the vehicle, instead of a warning lamp, sometimes a symbol may be displayed on the instrument panel.







When certain control and warning lamps are lit, an audible warning is also heard.

Red symbols







Symbol	Meaning ⇒ ⚠	See
	Do not continue driving! The electronic parking brake is on, the brake fluid level is too low or the brake system is faulty.	⇒ page 183
	Do not continue driving! Fault in the engine cooling system.	⇒ page 283
	Do not continue driving! Engine oil pressure too low.	⇒ page 279
	Do not continue driving! At least one of the vehicles doors is open, or is not correctly closed.	⇒ page 80
	Do not continue driving! The tailgate is open or is incorrectly closed.	⇒ page 84
	Do not continue driving! Fault in the steering.	⇒ page 167
	Engine cannot be started again! "AdBlue" level too low.	⇒ page 271
	Driver or passenger has not fastened seat belt.	⇒ page 21
	Use the foot brake!	Change ⇒ page 174 Brake ⇒ page 183
	Faulty generator.	⇒ page 288

Yellow symbols



	Front brake pads worn.	
	lights: ESC (ESP) faulty or off flashes: ESC (ESP) operating	⇒ page 183
	ASR (TCS) manually deactivated.	
	ABS faulty or does not work.	
	Electronic parking brake faulty.	⇒ page 183
	Rear fog light switched on.	⇒ page 95
	lights: Driving light totally or partially faulty.	⇒ page 326
	flashes: Fault in the adaptive light system.	⇒ page 95
	Fault in catalytic converter.	
	lights: pre-ignition of diesel engine. flashes: Fault in engine management.	⇒ page 228
EPC	Fault in engine management.	
	Diesel particulate filter blocked	
	Fault in the steering system.	⇒ page 167
	Tyre pressure too low.	⇒ page 293
	Fault in the tyre pressure gauge.	⇒ page 221
	Level of windscreen washer fluid too low.	⇒ page 105
	Fuel tank almost empty.	⇒ page 264

	flashes: Engine oil sensor faulty. lights: Insufficient engine oil.	⇒ page 279
	Fault in airbag system and seat belt tensioners.	⇒ page 31
OFF 	Passenger front airbag is off (PASSENGER AIR-BAG OFF ).	⇒ page 31
	Top up "AdBlue", or there is a fault in the "AdBlue" system.	⇒ page 271
	Fuel tank not closed correctly.	⇒ page 264
	Lane Assist is connected, but not active.	⇒ page 216



Green symbols

Symbol	Meaning ⇒ 	See
	Left or right turn signal.	⇒ page 95
	Hazard warning lights on.	⇒ page 312
	Use the foot brake!	Change ⇒ page 174 Brake ⇒ page 183
	Cruise control operating.	⇒ page 212
	Lane Assist is connected and active.	⇒ page 216

Blue symbols

Symbol	Meaning ⇒ 	See
	Headlight on or flasher on.	⇒ page 95
	Headlight adjustment (Light Assist) on.	

Colourless symbols

Symbol	Meaning ⇒ 	See
SAFE	Electronic immobiliser active.	⇒ page 170
	Service interval display	⇒ page 61

WARNING

If the warning lamps and messages are ignored, the vehicle may stall in traffic, or may cause accidents and severe injuries.

- Never ignore the warning lamps or text messages.
- Stop the vehicle safely as soon as possible.
- Park the vehicle away from the traffic, ensuring that there are no easily inflammable materials under the vehicle which could come into contact with the exhaust system (e.g. dry grass, fuel).
- A faulty vehicle represents a risk of accident for the driver and for other road users. If necessary, switch on the hazard warning lamps and put out the warning triangle to advise other drivers.
- Before opening the bonnet, switch off the engine and allow it to cool.
- In any vehicle, the engine compartment is a hazardous area and could cause severe injury ⇒ page 275.

CAUTION

Failure to heed the warning lamps and text messages when they appear may result in faults in the vehicle.

Instruments

Introduction

Additional information and warnings:

- Indicator lamps ⇒ page 54
- Gear engaged display (automatic gearbox) ⇒ page 174.
- Instructions for inspection intervals ⇒ Booklet Maintenance Programme



WARNING

Any distraction may lead to an accident, with the risk of injury.

- Do not handle the instrument panel controls when driving.

View of instrument panel

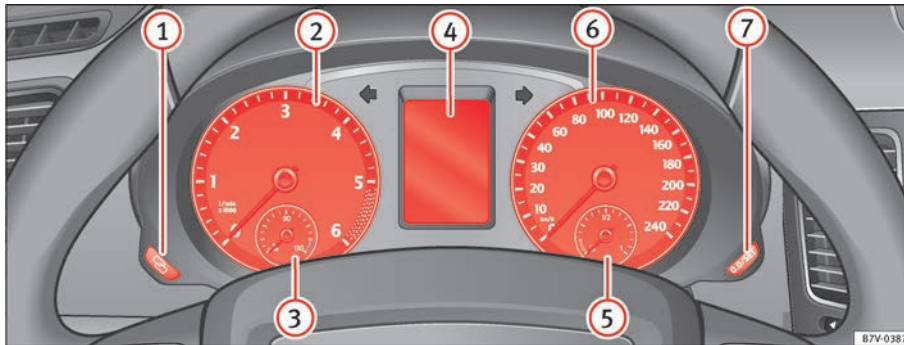







Fig. 35 Instrument panel, on dash panel.

Details of the instruments ⇒ fig. 35: ▶

¹⁾ Depending on the vehicle equipment, it is also possible to set the time using the **settings** menu on the instrument panel display ⇒ page 67.

- ① **Clock set button**¹⁾.
 - Press button  to select the hour or minute display.
 - To continue setting the time, press button  ⑦. Hold button down to scroll through the numbers quickly.
 - Press button  again to end the clock setting.
- ② **Rev counter** (with the engine running, in thousands of revolutions per minute).

The beginning of the red zone of the rev counter indicates the maximum speed in any gear after running-in and with the engine hot. However, it is advisable to change up a gear or move the selector lever to **D** (or lift your foot off the accelerator) before the needle reaches the red zone ⇒ ④.
- ③ **Engine coolant temperature display**  ⇒ page 283.
- ④ **Displays on the screen** ⇒ page 58.
- ⑤ **Fuel reserve display** ⇒ page 264.
- ⑥ **Speedometer.**
- ⑦ **Reset knob** for trip recorder (**trip**).
 - Press button  to reset to zero.

CAUTION

To prevent damage to the engine, the rev counter needle should only remain in the red zone for a short period of time.

For the sake of the environment

Changing up a gear in time reduces fuel consumption and noise. ■



- Warning and information texts
- Mileage
- Time
- Ambient temperature
- Compass
- Selector lever positions ⇒ page 174
- Recommended gear (manual gearbox) ⇒ page 174
- Multifunction display (MFI) and menus for different setting options ⇒ page 62
- Service interval display ⇒ page 61
- Second speed display (menu **Configuration**) ⇒ page 62
- Start/Stop operation indicator ⇒ page 59

Warning and information texts

The system runs a check on certain components and functions when the ignition is switched on and while the vehicle is moving. Faults in the operation are displayed on the screen using red and yellow symbols and messages on the instrument panel display (⇒ page 54) and, in some cases, with audible warnings. The display may vary according to the type of instrument panel fitted. ►

Displays on screen

A variety of information can be viewed on the instrument panel display ⇒ fig. 35 ④, depending on the vehicle equipment:

Type of message	Symbol colour	Meaning
Priority 1 warning.	Red	Symbol flashing or lit; partly combined with audible warnings.  Stop the vehicle! It is dangerous ⇒  ! Check the function that is faulty and repair it. If necessary, request assistance from specialised personnel.
Priority 2 warning.	Yellow	Symbol flashing or lit; partly combined with audible warnings. A faulty function, or fluids which are below the correct levels may cause damage to the vehicle! ⇒  Check the faulty function as soon as possible. If necessary, request assistance from specialised personnel.
Informative text.	–	Information relating to different vehicle processes.

Mileage

The *odometer* registers the total distance travelled by the car.

The *trip recorder (trip)* shows the distance travelled since the last trip recorder reset. The last digit of the trip recorder indicates distances of 100 metres or tenths of a mile.

Outside temperature display

When the outside temperature is below +4 °C (+39 °F), the symbol “ice crystal” (warning of risk of freezing) is also displayed next to the temperature. At first this symbol flashes and then it remains lit until the outside temperature rises above +6 °C (+43 °F) ⇒ .

When the vehicle is at a standstill, with the auxiliary heating on (⇒ page 163), or when travelling at very low speeds, the temperature displayed may be higher than the true outside temperature, as a result of the heat produced by the engine.

The temperatures measured range from -40 °C to +50 °C (-40 °F to +122 °F).

Compass

With the ignition on and the navigation system on, the cardinal point corresponding to the vehicle's direction of travel is displayed on the instrument panel ⇒ page 60.

Selector lever positions

The range of engaged gears of the selector lever is shown on the side of the lever, and on the instrument panel display. In positions **D** and **S**, and with the Tiptronic, the corresponding gear is also displayed.



Recommended gear (manual gearbox)

The recommended gear to save fuel is displayed on the instrument panel while you are driving ⇒ page 174.

Second speed display (mph or km/h)

In addition to the speedometer, the speed can also be displayed in a different unit of measurement (in miles or in km per hour). To change the units, in the **Settings** menu, select the option **Second speed** ⇒ page 62.

Vehicles without menu display on the instrument panel

- Switch on the engine.
- Press button  three times. The odometer display flashes on the instrument panel display.
- Press button  once. “mph” or “km/h” is displayed briefly instead of the odometer.
- This activates the second speed display. To switch it off, repeat the procedure.

This option cannot be disconnected in models destined for countries in which the second speed must always be visible.

Start/Stop operating display

Updated information relating to the status is displayed on the instrument panel ⇒ page 194. 

WARNING

If the warning lamps and messages are ignored, the vehicle may stall in traffic, or may cause accidents and severe injuries.

- Never ignore the warning lamps or text messages.
- Stop the vehicle safely as soon as possible.
- A faulty vehicle represents a risk of accident for the driver and for other road users. If necessary, switch on the hazard warning lamps and put out the warning triangle to advise other drivers.
- Park the vehicle away from the traffic, ensuring that there are no easily inflammable materials under the vehicle which could come into contact with the exhaust system (e.g. dry grass, fuel).

WARNING

Although the outside temperature is above freezing, some roads and bridges may be frozen.

- At an outside temperature of above +4 °C (+39 °F), even when the “ice crystal” is not visible, there may still be ice on the road.
- Never rely totally on the outside temperature display!

CAUTION

Failure to heed the warning lamps and text messages when they appear may result in faults in the vehicle.

Note

- Different versions of the instrument panel are available and therefore the versions and instructions on the display may vary. In the case of displays without warning or information texts, faults are indicated exclusively by the warning lamps.
- When several warnings are active at the same time, the symbols are shown successively for a few seconds. The symbols will stay on until the fault is rectified.

Compass*

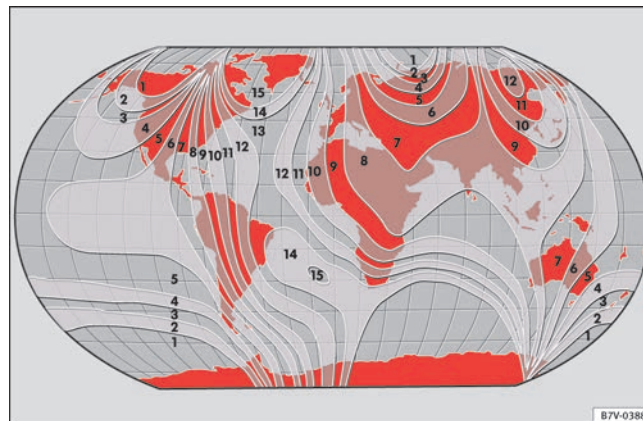

Fig. 36 Magnetic zones.

The compass does not require calibration in vehicles for which the navigation system was mounted at the factory. The option **compass** disappears.

The compass in vehicles in which the navigation system was not mounted at the factory, is permanently and automatically calibrated. If electronic or metal accessories (mobile phone, television) are subsequently mounted in the vehicle, the compass should be recalibrated manually.

Adjusting the magnetic zone

- Switch the ignition on.
- Select the **Settings** menu followed by the option **Compass** and **Zone**.
- Select the magnetic zone corresponding to the position of the vehicle → fig. 36.
- Adjust and confirm the magnetic zone (1-15). ▶

Calibrating compass

To calibrate the compass you must be in one of the valid magnetic zones with sufficient space to be able to trace a circumference with the vehicle.

- Switch the ignition on.
- Select the **Settings** menu followed by the option **Compass** and **Calibrate**.
- Confirm the message **Describe a complete circumference to calibrate the compass** with **OK** and then trace a complete circumference driving at approximately 10 km/h (6 mph).

When the corresponding cardinal point is displayed, the calibration is complete. ■

Service interval display

The inspection display appears on the instrument panel ⇒ fig. 35 ④.

SEAT makes a difference between services *with* engine oil change (Maintenance Service) and services *without* engine oil change (Inspection Service). The service interval display only gives information for service dates which involve an engine oil change. The dates of the remaining services (for example, the next Inspection Service or change of brake fluid) are listed on the label attached to the door strut, or even in the Maintenance Programme.

In vehicles with **Services established by time or mileage**, the service intervals are already pre-defined.

In vehicles with **LongLife Service**, the intervals are determined individually. Technical progress has made it possible to considerably reduce servicing requirements. The technology used by SEAT ensures that your vehicle only has a maintenance service when it is necessary. To establish when the Maintenance Service is due (max. 2 years), the vehicle's conditions of use and individual driving styles are considered. The service pre-warning first appears 20 days before the date established for the corresponding service. The kilometres remaining until the next service are always rounded up to

the nearest 100 km and the remaining time is given in complete days. The current service message cannot be viewed until 500 km after the last service. Prior to this only lines are visible on the display.

Inspection reminder

When the Service date is approaching, when the ignition is switched on a **Service reminder** is displayed.

In *vehicles without text messages*, a spanner is displayed on the instrument panel  with a figure given in **km**. The number of kilometres shown is the maximum number that may be driven until the next service. After a few seconds, the display mode changes. A clock symbol appears and the number of days until the next service appointment is due.



In *vehicles with text messages*, **Service in --- km or --- days** is displayed on the instrument panel.

Service due

After the **service date**, an audible warning is given when the ignition is switched on and the spanner displayed on the screen flashes for a few seconds . In *vehicles with text messages*, **Service in --- km or --- days** is displayed on the instrument panel.

Reading a service notification

With the ignition switched on, the engine off and the vehicle at a standstill, the current **service notification** can be read:

- Press the button  on the instrument panel several times until the spanner symbol is displayed .
- **ALTERNATIVELY:** select the **Settings** menu.
- From the **Service** submenu, select the option **Info**.

When the **service date has past**, a minus sign is displayed in front of the number of kilometres or days. In *vehicles with text messages* the following is displayed: **Service --- km or --- days ago**. ▶

The service interval display is reset

If the service was not carried out by a Technical Service, the display can be reset as follows:

In vehicles with text messages:

Select the **Settings** menu.

In the submenu **Service**, select the option **Reset**.

Confirm with **OK** when requested to do so by the system.

In vehicles without text messages:

Switch the ignition off.

Press and hold the **0.0 / SET** button.

Switch the ignition back on.

Release the **0.0 / SET** button and, press **⊞** for the next 20 seconds.

Do **not** reset the indicator to zero between two intervals, otherwise the display will be incorrect.

If, while the LongLife service is valid, the service interval display is reset to zero, the “service will be activated by time or mileage”. The service interval is no longer calculated individually ⇒ Booklet Maintenance Programme.



Note

- The service message disappears after a few seconds, when the engine is started or when **OK** is pressed.
- In vehicles with the LongLife system in which the battery has been disconnected for a long period of time, it is not possible to calculate the date of the next service. Therefore the service interval display may not be correct. In this case, please check the maximum permitted service intervals ⇒ Booklet Maintenance Programme.

SEAT information system

Introduction

With the ignition switched on, it is possible to read the different functions of the display by scrolling through the menus.

In vehicles with a multifunction steering wheel, there are no buttons on the windscreen wiper lever. The multifunction display can only be controlled from the buttons on the multifunction steering wheel.

The number of menus displayed on the instrument panel will vary according to the vehicle electronics and equipment.

A specialised dealer will be able to programme or modify additional functions, according to the vehicle equipment. SEAT recommends visiting a Technical Service.

Some menu options can only be read when the vehicle is at a standstill.

As long as a priority 1 warning is displayed, it will not be possible to read the menus. To display the menus, confirm the warning by pressing **OK**.

Additional information and warnings:

- Exterior mirrors ⇒ page 110
- Auxiliary heating ⇒ page 163



WARNING

Any distraction may lead to an accident, with the risk of injury.

- **Do not read the instrument panel menus when driving.**

Summary of the menu structure

- **Multifunction display (MFI)** ⇒ page 66
 - Journey duration
 - Current fuel consumption
 - Average fuel consumption
 - Distance to empty
 - Distance covered
 - Average speed
 - Digital display of speed
 - Oil temperature digital display
 - Speed warning
- **Audio** ⇒ Booklet Radio or ⇒ Booklet navigation system
- **Navigation** ⇒ Booklet Navigation system
- **Auxiliary heating** ⇒ page 163
 - Activation
 - Programme On / Off
 - Disconnection
 - Timer 1-3
 - Day
 - Time
 - Minute
 - Activate
 - Duration
 - Operating mode
 - Heat
 - Ventilation
 - Day
 - Default setting
- **Vehicle condition** ⇒ page 66
- **Configuration** ⇒ page 67
 - Multifunction display data
 - Journey duration
 - Current fuel consumption
 - Average fuel consumption
 - Distance covered
 - Distance to empty
 - Average speed
 - Digital display of speed
 - Speed warning
 - Compass
 - Convenience ⇒ page 68
 - Open door
 - Manual
 - automatic mode
 - Childproof locks On / Off
 - Anti-theft alarm confirmation On / Off
 - Handling windows
 - Off
 - All
 - Driver
 - Mirror adjustment On / Off
 - Rear-view mirror adjustment
 - Synchronised
 - Individual
 - Default setting
 - Lights & visibility ⇒ page 69
 - Coming Home
 - Leaving Home
 - Footwell light
 - Convenience indicators On / Off
 - Default setting



- Time
- Winter tyres
- Settings: Language
- Units
- Second speed display On / Off
- Autohold
- Tourist light On / Off
- Service
 - Info
 - Reset
- Default setting



Using the menus on the instrument panel

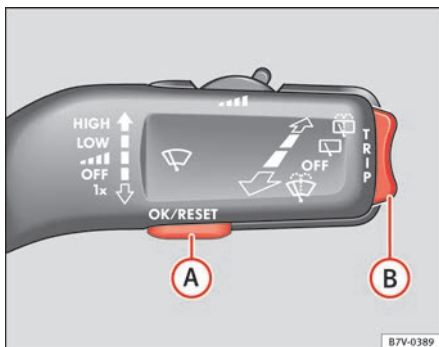

Fig. 37 In vehicles without multifunction steering wheel: On the windscreen wiper lever: button **A** to confirm the menu point and rocker switch **B** to change the menu

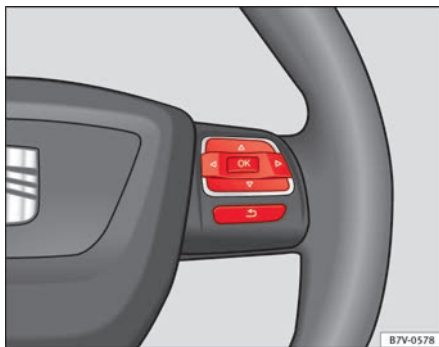

Fig. 38 Right side of multifunction steering wheel: Buttons to access the instrument panel menus.

Enabling the main menu

- Switch the ignition on.
- If a message or vehicle symbol is displayed, press **OK** (⇒ fig. 37 **A** or ⇒ fig. 38).
- *If managed from the windscreen wiper lever:* the main menu list is displayed.
- *If managed from the multifunction steering wheel:* the main menu list is not displayed. To scroll through the options of the main menu, press the arrow keys **←** or **→** several times ⇒ page 66.

Select a submenu

- Press the rocker switch ⇒ fig. 37 **B** upwards or downwards, or, on the multifunction steering wheel, the arrow keys **▲** or **▼**, until reaching the required menu option.
- The selected option is displayed between two horizontal lines. In addition, a triangle is displayed on the right ◀.
- To select the submenu, press **OK**.

Making changes according to the menu

- Use the rocker switch on the windscreen wiper lever or the arrow keys on the multifunction steering wheel to make the required modifications. If the switch or keys are held down, the scroll speed is faster (fast forward or return).
- Mark or confirm the selected option with **OK**.

Returning to the main menu

- *Via the menu:* in the submenu, select the option **Return** to exit the submenu.
- *If managed from the windscreen wiper lever:* hold down the rocker switch.
- *If managed from the multifunction steering wheel:* press button **↩**. ■

Main menu

Menu	Function	See
MFI	Information and possible configurations of the multifunction display (MFI).	⇒ page 66
Audio	If the radio is on, the station is displayed. In CD mode, the current CD is played.	⇒ Booklet Radio or ⇒ Booklet navigation system
Navigation	Navigation system information: when the navigation to destination is on, change of direction arrows and a proximity bar are displayed. These symbols are similar to those used in the navigation system. If navigation to destination is not on, the direction of travel (compass) and the name of the street on which you are driving are displayed.	⇒ Booklet Navigation system
Parking heating	Information and configurations of the parking heating: switching the parking heating on or off. Select the operating mode and duration.	⇒ page 163
Vehicle condition	Current warning or information texts. This option only appears when one of the following texts is available. The number of available messages is displayed. Example 1/1 or 2/2.	⇒ page 57
Settings	Different setting options, for example, the Convenience, Lighting & Visibility menus, and the time, speed warning with winter tyres, language, units of measurement, or "Display off".	⇒ page 67

MFI display menu

The multifunction display (MFI) has two automatic memories: **1 - Partial memory** and **2 - Total memory**. The selected memory will be shown in the upper right-hand corner of the display.

With the ignition switched on, and memory 1 or 2 displayed, briefly press  to change from one memory to another.

1	Trip memory (for a single journey).	The memory stores the values for the journey and the consumption from the moment the ignition is switched on until it is switched off again. If the journey is broken for more than two hours, the memory is automatically erased. If the journey is continued in less than two hours after the ignition is switched off, the new data is added to the data already stored in the memory.
2	Total memory (for all journeys).	The memory records the values for a specific number of partial trips, up to a total of 19 hours and 59 minutes or 99 hours and 59 minutes, or 1999.9 km (or miles) for 9999 km (or miles), depending on the model of instrument panel. On reaching either of these limits, the memory is automatically erased and starts to count from 0 again.

Possible displays

Menu	Function
Journey duration	This indicates the hours (h) and minutes (min) since the ignition was switched on.
Current fuel consumption	The current fuel consumption while driving is displayed in l/100 km (or miles per gallon, mpg); when the engine is running but the vehicle is not moving, in l/h (or gallons per hour). ▶

Menu	Function
Average fuel consumption	When the ignition is switched on, the average consumption (in l/100 km or in mpg) is displayed after the vehicle has moved approximately 100 metres (328 feet). Otherwise horizontal lines are displayed. The value shown is updated approximately every 5 seconds.
Distance to empty	Approximate distance in km (or miles) that can still be travelled with the fuel remaining in the tank, assuming the same style of driving is maintained. This is calculated using the current fuel consumption.
Distance covered	Distance travelled, after ignition is switched on, in km (or miles).
Average speed	After the ignition is switched on, the average speed will be shown after a distance of approximately 100 metres (328 feet) has been travelled. Otherwise horizontal lines are displayed. The value shown is updated approximately every 5 seconds.
Digital display of speed	Current speed displayed digitally.
Oil temperature digital display	Updated engine oil temperature digital display
Speed warning to --- km/h	If the stored speed is exceeded (between 30 - 250 km/h, or 18 - 155 mph), an audible warning is given together with a visual warning.

Changing between display modes

- In vehicles without multifunction steering wheel: press the lever.
- Vehicles with a multifunction steering wheel: press \square or ∇ .

Storing a speed for the speed warning

- Select the display **Speed warning at --- km/h**.
- Press \square to store the current speed and switch off the warning.

- In addition, set the required speed by pressing the rocker switch on the windscreen wiper lever or buttons \square or ∇ on the multifunction steering wheel for 5 seconds. Next, press \square again or wait a few seconds. The speed is stored and the warning activated.

- To switch off, press \square . The stored speed is deleted.

Manually erasing memory 1 or 2

- Select the memory to be erased.
- Press and hold \square for approximately two seconds.

Personalising the displays

It is possible to select which of the displays in the multifunction display you wish to see on the instrument panel in the **settings** menu. The units of measurement can also be modified \Rightarrow page 67.

Configuration Menu

Configuration Menu	Function
Multifunction display data	Configuration of the multifunction display data that you wish to see on the instrument panel display \Rightarrow page 66.
Compass	Changing the magnetic region and calibration of the compass. To calibrate the compass, please follow the instructions given on the instrument panel display.
Convenience	Changing vehicle convenience functions \Rightarrow page 68.
Lights & visibility	Configuration of vehicle lighting \Rightarrow page 69.
Time	Changing the hours and minutes of the clock and the navigation system. The time can be set here and the choice can be made between the 24 hour and 12 hour display. The S in the upper part of the display indicates that the clock is set to summer time.

Configuration Menu	Function
Winter tyres	Changing the visual and audible speed warnings. This function should only be used when the vehicle is fitted with winter tyres, which are not designed for travel at high speeds.
Settings: Language	Changing the language of the display texts and the navigation system.
Units	Changing the units of measurement for the temperature, consumption and distance.
Second speed	Switching second speed display on and off
Autohold	Selecting whether the Auto-Hold function should remain on permanently.

Configuration Menu	Function
Tourist light	Headlamp adjustment for countries in which vehicles are driven on the other side of the road. When the mark is activated, the headlamps of a left-hand drive vehicle are adjusted for driving on the left. This function must only be used for a short period.
Service	Check the service notifications or reset the service intervals to zero
Factory settings	Some functions of the Configuration menu will be reset to the factory value.
Back	The main menu is displayed again.

Submenu Convenience

Convenience menu	Function
Open door ⇒ page 74	Manual When the vehicle is unlocked with the key, the following doors (depending upon the configuration) are unlocked: ▷ all doors: All of the doors will be unlocked. ▷ one door: see above <i>Method 1</i> . ▷ Side of vehicle: The driver side doors will unlock. ▷ Individually: Only the driver's door is unlocked.
	automatic mode Automatic locking function (Auto Lock) All doors are automatically locked at speeds above approximately 15 km/h. To unlock when the vehicle is stopped, push the central locking button or remove the key from the ignition lock. Automatic unlock: When the key is removed from the ignition lock, all doors and the tailgate are unlocked.
Electronic childproof locks	Switching the childproof locks on or off ⇒ page 81.
Confirm anti-theft alarm	Switching on or off the audible confirmation that the anti-theft alarm is activated ⇒ page 74.

Convenience menu	Function
Handling windows	Adjusting the electric windows: This permits the windows to be opened or closed when the vehicle is unlocked or locked respectively. The open function can only be activated from the driver's door ⇒ page 89.
Rear-view mirror adjustment	Tilts passenger mirror downwards when reverse gear is engaged. This enables the driver to see the edge of the pavement, for example ⇒ page 110.
Exterior mirror adjust.	If synchronised adjustment is selected, when the driver side exterior mirror is adjusted, the passenger exterior mirror is also moved.
Factory settings	Some functions of the Convenience submenu will be reset to the factory value.
Back	The Configuration menu is displayed again.

Lights & visibility submenu

Lights & visibility menu	Function
Coming Home	This permits the adjustment of the time the headlamps stay on after locking or unlocking the vehicle, the function can also be connected or disconnected here ⇒ page 101.
Leaving Home	
Footwell light	This permits the adjustment of the brightness of the footwell lighting when the doors are open, the function can also be connected or disconnected here
Convenience indicators	Switching convenience indicators on and off When the convenience indicators are connected, when the indicator is switched on, these flash at least three times ⇒ page 95.
Factory settings	All the configurations in the submenu Lights & visibility are reset to the predefined factory values.
Back	The Configuration menu is displayed again.

Personal convenience settings

When two people use a vehicle, SEAT recommends that each person always uses “their” own remote control key. When the ignition is switched off, or the vehicle is locked, the personal convenience settings are stored and automatically allocated to the vehicle key ⇒ page 62.

The values of the personalised convenience settings of the following menu options are allocated to the vehicle key:

- **Parking heating** menu
- **Configuration** Menu
 - Time
 - Settings: Language
 - Units
- **Convenience settings** menu
 - Door unlock (individual opening, Auto Lock)
 - Convenience handling of windows
 - Rear-view mirror adjustment

- **Lights & visibility settings** menu
 - Coming home and leaving home
 - Footwell light
 - Convenience indicators

The stored settings are automatically activated, at the latest when the ignition is switched on. Please refer to the information and tips relating to the seat memory ⇒ page 117. ■

Unlocking and locking

Vehicle key set

Introduction

Additional information and warnings:

- Adjustments to the SEAT information system ⇒ page 62
- Central locking and locking system ⇒ page 74
- Start and stop the engine ⇒ page 170
- Notes for the user ⇒ page 255
- Emergency locking and unlocking ⇒ page 314

WARNING

Careless or incorrect use of vehicle keys may result in severe injury and accident.

- Always take all the keys with you whenever you leave the vehicle. Children and unauthorised individuals could lock the doors or the tailgate, start the engine or turn the ignition on activating electrical systems, for example: the electric windows.
- Never leave children or disabled people alone in the car. They could be trapped in the car in an emergency and will not be able to get themselves to safety. For example, depending on the time of the year, temperatures inside a locked and closed vehicle can be extremely high or extremely low resulting in serious injuries and illness or even death, particularly for young children.
- Never remove the key from the ignition if the vehicle is in motion. The steering may lock and it will not be possible to turn the steering wheel. ■

Vehicle key



Fig. 39 Vehicle keys.



Fig. 40 Vehicle key for vehicles with electric sliding doors. ►

Vehicle keys

With the vehicle key ⇒ fig. 39 or ⇒ fig. 40 the vehicle may be locked or unlocked remotely.

The vehicle key includes an emitter and batteries. The receiver is in the interior of the vehicle. The range of the vehicle key with remote control and new batteries is several metres around the vehicle.

If it is not possible to open or close the vehicle using the remote control key, this should be re-synchronised ⇒ page 74 or the battery changed ⇒ page 73.

Different keys belonging to the vehicle may be used.

Folding the key shaft in and out

When the button is pressed, the key shaft is released and unfolds.

To *fold it* press the button and fold the key shaft in until it locks in place.

Duplicate keys

To obtain a spare key and other vehicle keys, the vehicle chassis number is required.

Each new key must contain a microchip and be coded with the data from the electronic vehicle immobiliser. In vehicle key will not work if it does not contain microchip or the microchip has not been encoded. This is also true for keys cut for the vehicle.

The vehicle keys or new spare keys can be obtained from an authorised technical service, a specialist workshop or approved key service qualified to create this kind of key.

New keys or spare keys must be synchronised before use ⇒ page 74.



CAUTION

All of the vehicle keys contain electronic components. Protect the vehicle keys from damage, impacts and humidity.



Note

- Only use the key button when you require the corresponding function. Pushing the button unnecessarily could accidentally unlock the vehicle or trigger the alarm. It is also possible even when you are outside the radius of action.
- Key operation can be greatly influenced by overlapping radio signals around the vehicle working in the same range of frequencies (for example, radio transmitters, mobile telephones).
- Obstacles between the remote control and the vehicle, bad weather conditions and discharged batteries can considerably reduce the range of the remote control. ■

Indicator on the vehicle key



Fig. 41 Indicator light on the vehicle key.



Fig. 42 Indicator light on the vehicle key for vehicles with electric sliding doors.

When a button on the vehicle key is pressed, the indicator light flashes (arrow) ⇒ fig. 41 or ⇒ fig. 42 once briefly. If the button is pressed and held, the indicator blinks several times, for example: for the convenience opening function.

When the indicator light does not light upon pushing a button, the batteries of the vehicle key must be changed ⇒ page 73. ■

Changing the battery

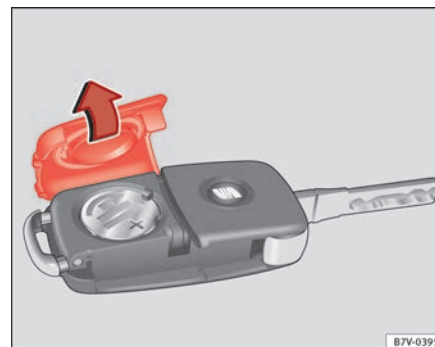

Fig. 43 Vehicle key: battery compartment cover.

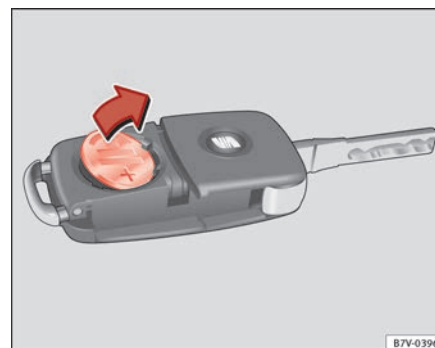

Fig. 44 Vehicle key: removing the battery. ►

SEAT recommend having the batteries changed in a Technical Service.

The battery is located to the rear of the vehicle key, under a cover ⇒ fig. 43.

When changing the battery, use another battery of the same model and observe the polarity when fitting it ⇒ ①.

To change the battery

- Unfold the key shaft ⇒ page 71.
- Remove the cover from the back of the vehicle key ⇒ fig. 43 in the direction of the arrow ⇒ ①.
- Extract the battery from the compartment using a suitable thin object ⇒ fig. 44.
- Place the new battery in the compartment, pressing in the direction of the arrow as shown ⇒ fig. 44 ⇒ ②.
- Fit the battery compartment cover, pressing in the direction of the arrow as shown ⇒ fig. 43 until it clicks into place.



CAUTION

- If the battery is not changed correctly, the vehicle key may be damaged.
- Use of unsuitable batteries may damage the vehicle key. For this reason, always replace the dead battery with another of the same voltage, size and specifications.



For the sake of the environment

- Please dispose of your used batteries correctly and with respect for the environment.
- The vehicle key battery may contain perchlorate. Observe the legal requirements for their disposal.

To synchronise the vehicle key

If the button ④ is pressed frequently outside of the vehicle range, it is possible that the vehicle can no longer be locked or unlocked using the key. In this case, the vehicle key must be synchronised once more as follows:

- Unfold the key shaft ⇒ page 72.
- Remove the cover from the driver's door handle ⇒ page 314.
- Press the button ④ on the vehicle key. For this, it must remain with the vehicle.
- Open the vehicle within one minute using the key shift.
- Turn on the ignition using the vehicle key. The key has been synchronised.
- Replace the driver's door handle cover. ■

Central locking and locking system

Introduction

Central locking functions correctly when all the doors and the tailgate are correctly shut. If the driver's door is open, the vehicle *cannot* be locked with the key.

The battery of a vehicle left unlocked during a long period (for instance, in a private garage) may run down and fail to start the motor.

Additional information and warnings:

- Personal convenience settings in the SEAT information system ⇒ page 62
- Vehicle key set ⇒ page 71
- Sliding doors ⇒ page 81 ▶

- Electric windows ⇒ page 89
- Panorama sliding sunroof ⇒ page 92
- Towing mode ⇒ page 233
- Emergency locking and unlocking ⇒ page 314



WARNING

The incorrect use of the central locking system may cause serious injuries.

- The central locking system will lock all doors. A vehicle locked from the inside can prevent any non-authorized individual from opening the doors and accessing the vehicle. Nevertheless, in case of emergency or accident, locked doors will complicate access to the passenger compartment to help the passengers.
- Never leave children or disabled people alone in the vehicle. The central locking button can be used to lock all the doors from within. Therefore, passengers will be locked inside the vehicle. Individuals locked in the vehicle can be exposed to very high or very low temperatures.
- Depending on the time of the year, temperatures inside a locked and closed vehicle can be extremely high or extremely low resulting in serious injuries and illness or even death, particularly for young children.
- Never leave individuals locked in a closed and locked vehicle. In case of emergency, they may not be able to exit the vehicle by themselves or get help.

In the submenu **Convenience** in the **Configuration** menu, or by visiting a specialized workshop, special functions of the central locking system can be switched on or off ⇒ page 62.

In case of a vehicle key fault or central locking system fault, all doors can be locked or unlocked manually.

Locking the vehicle after the airbags have been deployed

If the airbags are deployed due to an accident, the vehicle will be automatically and completely unlocked. Depending on the amount of damage, the vehicle can be locked following an accident in the following ways:

Function	Necessary operations
Locking the vehicle from within :	– Turn off the ignition and turn it on again. – Push the central locking button  .
Locking the vehicle from the outside :	– Turn off the ignition and turn it on again. OR: – Remove the key from the ignition. – Open any door just once. – Lock the vehicle with the key.

Description of the central locking system

The central locking system allows all doors and the tailgate to be locked and unlocked centrally.

- From outside, using the vehicle key.
- From inside, by pushing the central locking button ⇒ page 77.

Locking and unlocking the vehicle from the outside



Fig. 45 Buttons on the vehicle key.



Fig. 46 Buttons on the key of vehicles with sliding doors.

Function	Handling the buttons on the vehicle
Unlocking the vehicle.	Press button . Keep it pushed for the convenience opening.
Lock the vehicle.	Press button . Keep it pushed for the convenience locking function.
Unlocking the tailgate.	Press button .
Open the sliding door.	⇒ page 81.

Attention: Depending on the selected function in the central locking sub-menu **Convenience**, you may push the button twice ⇒ page 62 to unlock all doors and the tailgate.

The vehicle key only locks and unlocks the vehicle if it is within range of the vehicle and if the batteries have enough power. When locking, the vehicle's indicators will blink.

If the driver's door is open, the vehicle cannot be locked with the key. If you unlock the vehicle without opening any doors or the tailgate, it will lock again automatically after a few seconds. This function prevents the vehicle from remaining unlocked if the unlocking button is pressed by mistake.

Convenience open/close function

- See "Electric windows: functions" ⇒ page 89.
- See "Panorama sliding sunroof: operation" ⇒ page 92. ■

Locking and unlocking the vehicle from the inside

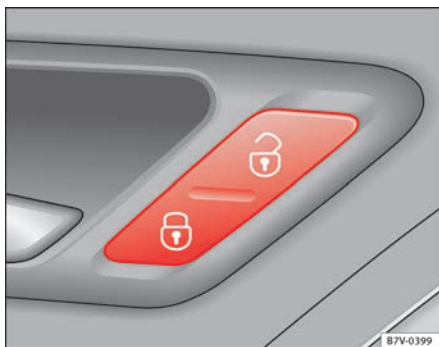



Fig. 47 In the driver door: central locking button.

Push the button ⇒ fig. 47:

-  Unlocking the vehicle.
-  Lock the vehicle.

The central locking button is still operative when the ignition is switched off.



The central locking button is only deactivated if the "Safe" security system is activated ⇒ page 77.

Please note the following when you use the central locking button to lock your vehicle:

- **Do not** turn on the "Safe" security system ⇒ page 77.
- **Do not** turn on the antitheft alarm.
- It will not be possible to open the doors or the tailgate from the *outside* this may offer extra safety, when stopped at traffic lights for example.

- The doors can be opened and unlocked individually from the inside by pulling the inside door handle. If necessary, pull the door release lever twice.
- The driver's door cannot be locked when it is still open. This avoids locking the vehicle key inside the vehicle when there is nobody inside. ■

"Safe" security system

Function	Necessary operations
Locks the vehicle with the "Safe" security system.	Press the  button <i>once</i> on the vehicle key.
Locks the vehicle without the "Safe" security system.	Press the  button <i>twice</i> on the vehicle key. Press the central locking button  on the driver's door once.

When the vehicle is locked, the "Safe" security system deactivates the door handles and the central locking button making the vehicle difficult to open. The doors cannot be opened from inside ⇒ .

When the "Safe" security system is turned off:

- The vehicle can be opened and unlocked from the inside using an inside door handle.
- The vehicle may be unlocked from the inside by pushing the central locking button.
- The anti-theft alarm will be activated.
- The vehicle interior monitoring system and the anti-tow system are deactivated. ►

Driver's door indicator light.

When the vehicle is locked:	Meaning
The red LED flashes for approximately 2 seconds at short intervals and then more slowly.	The "Safe" security system is switched on.
The red LED flashes for about two seconds then turns off. After 30 seconds, the LED flashes again.	The "Safe" security system is switched off.
The red LED remains lit for about 30 seconds.	There is a fault in the locking system. Contact a specialist workshop.

**WARNING**

Careless use of the "Safe" security system can cause serious injury.

- **Never leave anybody inside the vehicle if this is locked using the key. When the "Safe" security system is activated, doors cannot be opened from the inside.**
- **When the doors are locked, it is difficult to get to passengers in the passenger compartment in case of an emergency. Passengers could remain trapped inside in case of emergency.**

Antitheft alarm

The anti-theft alarm makes it more difficult to break into the vehicle or steal it.

The antitheft alarm is automatically turned on when the vehicle is locked with the key.

When does the system trigger an alarm?

The anti-theft alarm siren will be triggered for about 30 seconds accompanied by optical warning signals for about five minutes when the vehicle is locked and the following unauthorised actions are taken:

- When the door is mechanically unlocked using the vehicle key without turning the ignition within the following 15 seconds.
- A door is opened.
- The bonnet is opened.
- The tailgate is opened.
- When the ignition is switched on with a non-authorised key.
- When the vehicle battery is disconnected.
- When there is movement inside the vehicle (vehicles with interior monitoring).
- When the vehicle is towed (vehicles with anti-tow system)
- When the vehicle is lifted (vehicles with anti-tow system).
- Transporting the vehicle on a ferry or by railroad (vehicles with an anti-tow system or passenger compartment monitoring).
- Unhitch a trailer connected to the antitheft alarm ⇒ page 233.

How to turn OFF the alarm

Unlock the vehicle with the unlocking button on the key or turn on the ignition with a valid key.

**Note**

- The alarm will be triggered once more when anybody enters the same zone of surveillance or any other zone. If, for example, after opening a door, the tailgate is also opened.
- The antitheft alarm **is not** activated when the vehicle is locked from within using the central locking button .

- If the driver's door is unlocked mechanically with the key, only the driver's door is unlocked, the rest of the doors remain locked. Only when the ignition has been turned on will the other doors be available - but not unlocked - and the central locking button activated.
- If the vehicle battery is run down or flat then the antitheft alarm will not operate correctly. ■

Interior monitoring system and anti-tow system*



Fig. 48 Driver's seat: button for switching off the interior monitoring system and the anti-tow system.

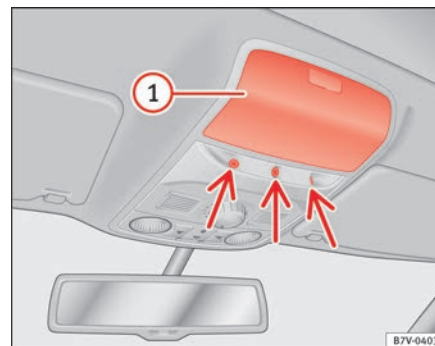

Fig. 49 On the roof console: interior monitoring sensors.

The interior monitoring system triggers the alarm if the vehicle is locked and movement is detected inside the vehicle. The anti-tow system triggers the alarm if the vehicle is locked when the system detects the vehicle is being raised.

Switching on the interior monitoring and the anti-tow systems

Close the storage compartment ⇒ fig. 49 ① on the roof console otherwise the interior of monitoring function (arrow) may not work without restrictions.

Use the key to lock the vehicle. If the antitheft alarm is turned on, the interior monitoring and the anti-tow systems are also activated.

Switching off the interior monitoring and the anti-tow systems

To turn off the system, the reading light on the button ⇒ fig. 48 must be lit. To turn on the reading light, remove the key from the ignition or open a door. ▶

- Push the  button. A yellow warning lamp will light up in the button until the vehicle is locked.
- Lock all doors and tailgate.
- Use the key to lock the vehicle. The interior monitor and / or anti-towing alarm are switched off until the next time the vehicle is locked.

To turn off the interior monitoring and anti-tow systems before unlocking the vehicle, for example in the following situations:

- When leaving animals inside the vehicle  ⇒ page 74.
- When the vehicle must be loaded.
- When the vehicle is being transported, for example, by ferry.
- When the vehicle must be towed with the axle raised.

Risk of false alarms

The interior monitoring system only operates correctly if the vehicle is completely closed. Observe legal requirements. The alarm may be accidentally triggered in the following cases:

- When a window is completely or partially open.
- If the sunglasses storage compartment in the roof console is open.
- When the panorama sliding sunroof is completely or partially open.
- When suspended objects are hung from the interior mirror (air freshener) or there are loose papers in the vehicle.
- If the separation net is fitted and moves (due to heating).
- Due to a vibrating mobile telephone inside the vehicle.



Note

Upon activating the alarm, if any door or the tailgate is open, only the alarm will be activated. The interior monitoring and anti-tow systems will only be activated when the doors and tailgate are fully closed. ■

Doors

Introduction

Additional information and warnings:

- Vehicle key set ⇒ page 71
- Central locking and locking system ⇒ page 74
- Emergency locking and unlocking ⇒ page 314

WARNING

If a door is not correctly closed, it could open unexpectedly when driving and cause serious injuries.



- **Always stop immediately and close the door.**
- **When closing, ensure that the door has closed correctly. A closed door should be flush with the corresponding parts of the bodywork.**
- **Open and close doors only when nobody is in the way of the door.**

WARNING



A door held open by its retainer could be blown closed by the wind or close if the vehicle is on a hill causing injury.

- **When opening and closing doors, always use the door handle.** ■

Warning indicator

lights up	Possible cause	Solution
	At least one vehicle door is open or not correctly shut.	 Stop driving immediately! Open the corresponding door and close it immediately. ►

Several warning and control lamps should light up for a few seconds when the ignition is switched. This signals that the lamp is working properly. They will switch off after a few seconds.

If a door is open or incorrectly closed, the indicator  or  on the instrument panel will light.

Depending on the vehicle equipment, a symbol may be displayed on the instrument panel screen instead of the warning lamp. The indication is also visible when the ignition is switched off. The indication disappears around 15 seconds after the vehicle has been locked. ■

Sliding doors

Introduction

Additional information:

- Vehicle key set ⇒ page 71
- Central locking and locking system ⇒ page 74
- Emergency locking and unlocking ⇒ page 314

WARNING

If a sliding door is not correctly closed, it could open unexpectedly when driving and cause serious injuries.

- Always stop immediately and close the sliding door.
- When closing, ensure that the sliding door has closed correctly. A closed sliding door should be flush with the corresponding parts of the bodywork.
- Only open and close sliding doors when no body is in the way of the door.

WARNING

If a sliding door is not fully open, it could close unexpectedly and cause serious injuries.

- Always open the sliding door fully.

WARNING

Opening sliding doors while driving is dangerous. The sliding door could be pushed open or closed when the vehicle accelerates and brakes causing serious injuries.

- Never open the sliding doors when the vehicle is in movement. ■

Manually opening and closing the sliding door

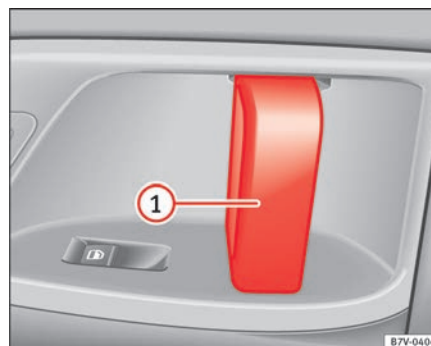

Fig. 50 On the sliding door, door handle ①. ►

Function	Necessary operations
Open the sliding door from the inside.	When the sliding door is released, open the door fully by pulling on the outside handle.
Opening the sliding door from the inside.	When the sliding door is released, open the door fully by pulling on its interior handle ⇒ fig. 50 ①.
Closing the sliding door.	Pull on the inside or outside door handle and close the sliding door by pushing gently. Make sure that the sliding door is closed properly. ■

Opening and closing the sliding door electrically*

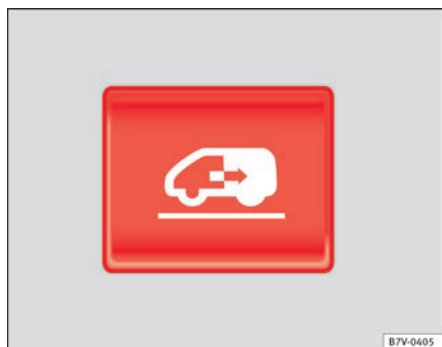

Fig. 51 On the instrument panel, on the remote control key and on the interior lining of the sliding door: Button for opening and closing the electric sliding door.

All of the electric sliding doors can be opened and closed manually using more force.

Function	Necessary operations
Opens the sliding door electrically.	Press the ⇒ fig. 51 button on the instrument panel, on the remote control key and on the interior lining of the sliding door. The sliding door opens with the rollback anti-trap function as long as the button is not pressed again. Pull briefly on the interior or exterior handle the door. The sliding door opens automatically.
Closing the sliding door electrically.	Press the ⇒ fig. 51 button on the instrument panel, on the remote control key and on the interior lining of the sliding door. The sliding door closes with the rollback anti-trap function as long as the button is not pressed again. As it closes, a warning sound is given. Pull briefly on the interior or exterior handle the door. The sliding door closes with the roll-back function. As it closes, a warning sound is given.

Note

- When the fuel tank cover is open, the right-hand side electric sliding door is locked and can only be opened manually.
- If the window of a sliding door is lowered then this door cannot open fully. ■

Rollback anti-trap function of the electric sliding doors

The rollback anti-trap function of the electric sliding doors can reduce the risk of injury when opening and closing the sliding doors ⇒ ⚠. ▶

If an object gets in the way of the sliding door while it is *closing*, it opens again.

If an object gets in the way of the sliding door while it is *opening*, the door stops moving.

- Check the reason for which the sliding door does not open or close.
- Try to open or close the sliding door again.

To close the sliding door without the rollback anti-trap function

- Turn off the ignition and turn it on again.
- Press and hold the  ⇒ fig. 51 button. **The sliding door closes with full force.**

WARNING

Closing the electric windows without the anti-trap function can cause serious injury.

- **Always close the sliding doors carefully.**
- **Nobody should ever get in the way of the electric sliding doors, especially when closing without the anti-trap function.**
- **The anti-trap function does not prevent fingers or other parts of the body getting pinched against the window frame and causing injury.**

Electric child safety lock

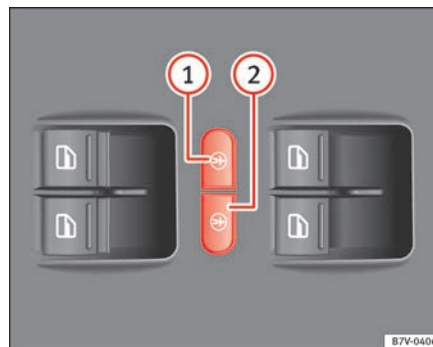



Fig. 52 In the driver door: electric child safety locks buttons.

The electric child safety lock avoids opening and locking of the sliding door and its electric windows from the inside so that children cannot accidentally open the door while the vehicle is being driven. Using the left-hand side ⇒ fig. 52 ① or right-hand side ② button, the child safety lock is activated on the left hand side or right-hand side respectively.

Turning on and off the electric child safety

Function	Necessary operations
To switch system on:	Press the button ⇒ fig. 52 ① o ②.
The system switches off:	Press the button again.

The yellow indicator  indicates that the function is on for the correspond- ing button.

In the menu **Configuration - Convenience** the electric child safety function can be configured to turn on automatically when the engine starts ⇒ page 62. ►

WARNING

When the electric child safety function is activated, the sliding door can be opened from the outside only.

- Never leave children or disabled people alone in the vehicle if the doors are to be locked. Therefore, passengers will be locked inside the vehicle. They could be trapped in the car in an emergency and will not be able to get themselves to safety. Individuals locked in the vehicle can be exposed to very high or very low temperatures.
- Depending on the time of the year, temperatures inside a locked and closed vehicle can be extremely high or extremely low resulting in serious injuries and illness or even death, particularly for young children.

Tailgate

Introduction

Additional information and warnings:

- Central locking ⇒ page 74
- Transporting ⇒ page 13
- Emergency locking and unlocking ⇒ page 314

WARNING

Careless and unsuitable locking, opening and closing of the tailgate can cause accidents and serious injury.

- Open and close the tailgate only when nobody is in the way.
- Do not close the tailgate by pushing it down with your hand on the rear window. The rear window could break and cause injury.



WARNING (Continued)

- Ensure the tailgate is locked after closing, otherwise, it may open unexpectedly while driving. A closed tailgate should be flush with the corresponding parts of the bodywork.
- Always keep the tailgate closed while driving to avoid toxic gases entering the passenger compartment.
- Do not open the tailgate when there is a load carrier installed. Likewise, the tailgate cannot be opened when a load is attached to it, for example bicycles. An open tailgate could close itself if there is an additional weight on it. If necessary, press down on the tailgate and remove the load.
- Close and lock both the tailgate and all the other doors when you are not using the vehicle. Ensure that nobody remains inside the vehicle.
- Never allow children to play inside or around the vehicle without supervision, especially if the tailgate is open. Children could enter the luggage compartment, close the tailgate and become trapped. Depending on the time of the year, temperatures inside a locked and closed vehicle can be extremely high or extremely low resulting in serious injuries and illness or even death, particularly for young children.
- Never leave children or disabled people alone in the vehicle. If the vehicle key or the central locking button is used, they may be locked in the vehicle.

CAUTION

Before opening the tailgate, ensure that there is sufficient free space to open and close it, for example if you are towing a trailer or in a garage.

Warning indicator

lights up	Possible cause	Solution
	The tailgate is open or not correctly shut.	 Stop driving immediately! Open the tailgate and close it again.

Several warning and control lamps should light up for a few seconds when the ignition is switched. This signals that the lamp is working properly. They will switch off after a few seconds.

A warning appears on the instrument panel  if the tailgate is open or not properly closed.

Depending on the vehicle equipment, a symbol may be displayed on the instrument panel screen instead of the warning lamp. The indication is also visible when the ignition is switched off. The indication disappears around 15 seconds after the vehicle has been locked.

WARNING

If the tailgate is not correctly closed, it could open unexpectedly when driving and cause serious injuries.

- Always stop immediately and close the tailgate.
- Ensure that the tailgate has been locked into place by the element on the lock carrier when you close it.

Opening the tailgate

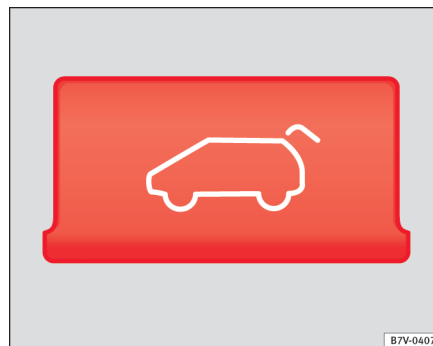



Fig. 53 Detailed view of the centre console: button for unlocking the tailgate.



Fig. 54 Opening the tailgate from the exterior

Before opening the tailgate, always remove any load on its luggage rack
⇒ .

Opening with the ignition key

Press the button  on the vehicle key until the tailgate opens automatically.

To open using the centre console control

Press the  button on the centre console ⇒ fig. 53. The tailgate will be automatically opened.

The button is still operative when the ignition is switched off.

Opening the tailgate with the button

- Unlock the vehicle or open a door.
- Raise the tailgate using the button ⇒ fig. 54 (arrow).



WARNING

Unsuitable or careless unlocking and opening of the tailgate could cause serious injuries.

- If there is a loaded luggage carrier on the tailgate, it could be unlocked or open but not recognised as such. An unlocked or open tailgate could open unexpectedly while driving.



Note

At outside temperatures of less than 0 °C (+32 °F), the pressurised gas struts cannot always automatically lift the tailgate. In this case, open the tailgate manually.

Closing the tailgate

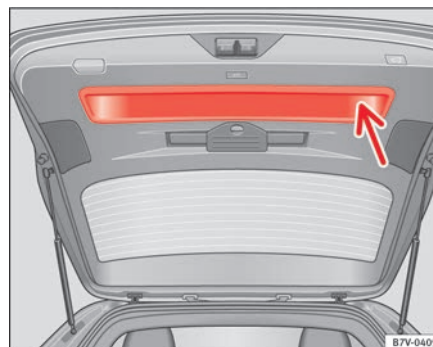

Fig. 55 Tailgate open: hand grip.

Closing the tailgate

- Grab the handgrip inside the tailgate ⇒ fig. 55 (arrow).
- Push the tailgate downwards until it locks into place in the lock.
- Ensure that it is correctly closed by pulling on it firmly.

Locking the tailgate

If you unlock the vehicle without opening any doors or the tailgate, it will lock again automatically after 30 seconds. This function prevents the vehicle from remaining unlocked if the unlocking button is pressed by mistake.

Locking is only possible when the tailgate is correctly and fully closed.

- The tailgate is also locked by a central locking.
- If the vehicle tailgate is locked or unlocked using the  button, when it is closed once more it will lock automatically.
- A closed but not locked tailgate will lock automatically at a speed above about 9 km/h (7 mph).

WARNING

Unsuitable or careless closing and locking of the tailgate could cause serious injuries.

- Never allow children to play inside or around the vehicle without supervision, especially if the tailgate is open. Children could enter the luggage compartment, close the tailgate and become trapped. A locked vehicle can be subjected to extremely high and low temperatures, depending on the time of year, thus causing serious injuries/illness and even death.

Note



Before closing the tailgate, make sure that the key has not been left inside the boot.

Opening the tailgate electronically



Fig. 56 Button with tailgate open.

Opening the tailgate





- Press and hold the  button on the vehicle key until the tailgate opens automatically.
- **ALTERNATIVELY:** Press and hold the  button on the centre console for approximately 1 second ⇒ fig. 53.
- **ALTERNATIVELY:** Press the ⇒ fig. 54 tailgate button (arrow).

In case of difficulty or obstruction, automatic opening of the tailgate is interrupted.

Electronically opening the tailgate does not work when a trailer is electrically connected and hitched to a factory fitted trailer hitch ⇒ page 233.

The tailgate can be opened manually by applying more force.

Closing the tailgate

- Press and hold the  button on the vehicle key for approximately 1 second.
- **ALTERNATIVELY:** Press and hold the  button on the centre console for approximately 1 second ⇒ fig. 53.
- **ALTERNATIVELY:** Press the ⇒ fig. 54 tailgate button (arrow).
- Press the  button on the open tailgate ⇒ fig. 56 ⇒ .
- Manually push the tailgate down to close it.



The tailgate will move down to the closed position to close and lock itself automatically using the power-close feature ⇒ .

In case of difficulty or obstruction, automatic closing of the tailgate is interrupted and it will open slightly.

Check why the tailgate could not close.

Attempt to close it once more.

Interrupting the opening and closing process

Tailgate opening and closing can be stopped by pressing one of the  buttons. Each time one of the  buttons is pressed, the tailgate moves to its initial position.

Then, it can be opened or closed by hand. To do this, apply a little more force.

Memorising the opening angle

The tailgate must be at least half open to memorise an opening angle.

- Stop automatic opening in the opening position required ⇒ page 88.
- Hold down the button ⇒ [fig. 56](#) with the tailgate open for at least three seconds. The opening angle is memorised.

Memorisation is confirmed by blinking of the hazard lights and a sound signal.

To be opened completely, the opening angle must be memorised once more.

- Release the tailgate and open it to the memorised height.
- Push the tailgate all the way up. To do this, apply a little more force.
- Hold down the button ⇒ [fig. 56](#) with the tailgate open for at least three seconds.
- The opening angle is reset to the original factory setting.

WARNING

Unsuitable or careless closing and locking of the tailgate could cause serious injuries.

- **Never allow children to play inside or around the vehicle without supervision, especially if the tailgate is open. Children could enter the luggage compartment, close the tailgate and become trapped. A locked ve-**

WARNING (Continued)

hicle can be subjected to extremely high and low temperatures, depending on the time of year, thus causing serious injuries/illness and even death.

WARNING

It is possible that the tailgate does not open completely or, if it is open, closes alone if a large amount of snow has built up on it or if a luggage rack is fitted. In this case, the tailgate must be supported.

CAUTION

- When using a trailer, ensure that there is sufficient space to open and close the tailgate.
- Before opening the tailgate, any kind of equipment carrier should be removed, for example a bicycle carrier.

CAUTION

In case of repeated short-term use, the system is turned off to avoid overheating.

- When it has cooled, it may be used once again. During this time, the tailgate may be manually opened or closed applying a little more effort.
- If the vehicle battery is disconnected or the fuse blows when the tailgate is open, the tailgate system must be re-initialised. To do this, close the tailgate.

Note

Before closing the tailgate, make sure that the key has not been left inside the boot. ■

Electric windows

Introduction

Additional information and warnings:

- SEAT information system ⇒ page 62
- Central locking and locking system ⇒ page 74

WARNING

Careless use of the electric windows can cause serious injury.

- Only operate the electric windows when nobody is in the way.
- Never leave children or disabled people alone in the vehicle if the doors are to be locked. The windows cannot be opened in case of an emergency.
- Always take all the keys with you whenever you leave the vehicle. After turning off the ignition, the windows can be opened and closed for a short time using the buttons on the door as long as the driver's door or passenger side door is not open.
- When transporting children in the rear seats, always deactivate the rear electric windows with the child safety lock so that they cannot be opened and closed.

Opening and closing the electric windows

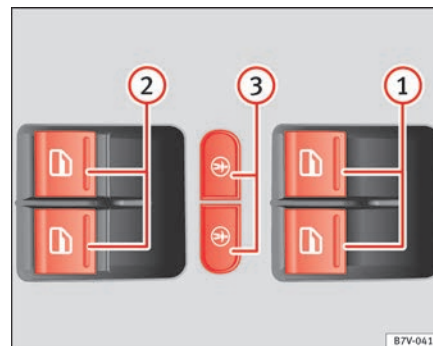





Fig. 57 In the driver door: Buttons for front and rear electric windows and child safety lock.

Buttons on the driver door

Legend for the fig. 57:

- ① For the front electric windows.
- ② For the sliding door electric windows.
- ③ To lock the sliding doors and their windows.

Opening and closing the windows

Function	Necessary operations
Opening:	Press button  .
Closing:	Push the button  .
To stop the one touch function:	Press or pull on the corresponding window button.
	Press the button  for the electronic child safety lock to deactivate the controls for the windows on the sliding doors and to lock these doors ⇒ page 81. The button will light up.

After turning off the ignition, the windows can be opened and closed for a short time using the buttons on the door as long as the driver's door or passenger side door is not open. When the key is removed from the ignition and the driver's door is open, all of the electric windows can be opened or closed using the corresponding button on the driver's door. After a few seconds, the convenience opening or closing function will begin ⇒ page 90. ■

Electric windows: functions

One-touch opening and closing

The one-touch automatic opening and closing is used to open or close the windows completely. It will not be necessary to hold the button of the corresponding electric window.

For the one-touch closing function: pull up on the button for the window to the second position.

For the one-touch opening function: Push down the button for the window to the second position.

To stop the one touch function: Push or pull on the button of the corresponding window.

Restoring one-touch opening and closing

The one-touch opening and closing function is not active after the vehicle battery has been disconnected or is flat and will have to be reset.

- Close all windows and doors.
- Pull the button of the corresponding window and hold it for one second in this position.
- Release the button and pull upwards and hold again. The one-touch function is now ready for operation.

The automatic one-touch electric windows can be reinitialised individually or several at a time.

Convenience opening and closing function

The electric windows can be opened or closed from outside using the vehicle key:

- Hold in the unlocking for locking button for the vehicle. All windows which function electrically will be either opened or closed.
- To interrupt the function, release the locking or unlocking button.

During convenience closing, first the windows and then the sliding sunroof will be closed.

In the **Configuration - convenience** menu, there are different settings for operating the windows ⇒ page 62.



WARNING

Careless use of the electric windows can cause serious injury.

- Only operate the electric windows when nobody is in the way.
- Never leave children or disabled people alone in the vehicle if the doors are to be locked. The windows cannot be opened in case of an emergency.
- Always take all the keys with you whenever you leave the vehicle. After turning off the ignition, the windows can be opened and closed for a short time using the buttons on the door as long as the driver's door or passenger side door is not open.
- When transporting children in the rear seats, always deactivate the rear electric windows with the child safety lock so that they cannot be opened and closed.



Note

The one-touch function and roll-back function will not work if there is a malfunction in the electric windows. Visit a specialist workshop. ■

Electric Windows anti-trap function

The anti-trap function of the electric windows can reduce the risk of injury when opening and closing the electric windows ⇒ ⚠. If a window is not able to close because it is stiff or because of an obstruction, it will automatically open again.

- Check why the window does not close.
- Attempt to close the window again.
- If you try within the following 10 seconds and the window closes with difficulty or there is an obstruction once again, the one-touch closing will stop working for 10 seconds.
- If the window is still obstructed, it will stop at the corresponding position. When the button is operated within 10 seconds, the window will close **without the anti-trap function** ⇒ ⚠.

To close windows without the anti-trap function

- Attempt to close the corresponding electric window within 10 seconds after by holding the button. **The window is closed without the anti-trap function, deactivated for a short time.**
- After more than 10 seconds, the anti-trap function is reactivated. The window will stop once again if there is another difficulty or obstacle.
- If the window will still not close, visit a specialised workshop.



WARNING

Closing the electric windows without the anti-trap function can cause serious injury.

- Always close the electric windows carefully.
- Nobody should be in the way of the electric windows, especially when the anti-trap function is deactivated.
- The anti-trap function does not prevent fingers or other parts of the body getting pinched against the window frame and causing injury.



Note

The anti-trap function also operates if the windows are closed from the outside of the vehicle using the ignition key for convenience closing ⇒ page 90.

Panorama sliding sunroof*

Introduction

Additional information and warnings:

- SEAT information system ⇒ page 62
- Central locking and locking system ⇒ page 74
- Emergency locking and unlocking ⇒ page 314

WARNING

Careless use of the panorama sliding sunroof can cause serious injury.

- Only close the panorama sliding sunroof and the sunshade when nobody is in the way.
- Always take all the keys with you whenever you leave the vehicle.
- Never leave children or disabled persons in the vehicle, particularly if they have access to the keys. Uncontrolled use of the key could lock the vehicle, start the engine, turn on the ignition and operate the sliding sunroof.
- The sliding sunroof can be operated for up to about ten minutes after the ignition has been switched off, provided the driver door and the front passenger door are not opened.



Note

In case of a fault in the operation of the sliding sunroof, the anti-trap function will not operate correctly. Visit a specialist workshop.

Opening or closing the panorama sliding sunroof

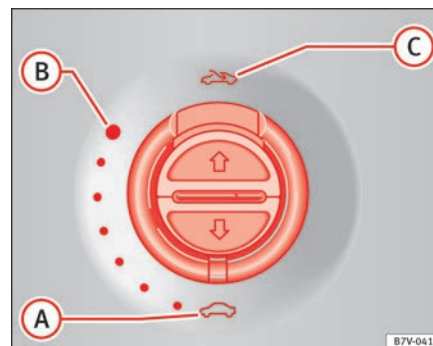

Fig. 58 On the interior roof lining: use the rotary button to open and close.

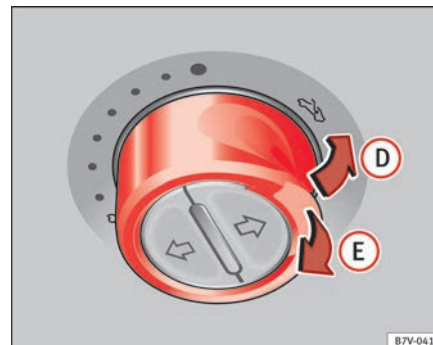

Fig. 59 On the interior roof lining: Press the button and pull on it to lift and close the sliding sunroof.

To unfold the panorama sliding sunroof, the switch must be in the position



Function	Switch setting	Necessary operations
	⇒ fig. 58	
To open the sliding sunroof completely:	C	Rotate the switch to the required position.
To choose the convenience position for the sliding sunroof:	B	
To close the sliding sunroof completely:	A	
	⇒ fig. 59	
To completely deploy the roof deflector:	D	Briefly push the switch up (arrow).
To stop automatic operation:	D or E	Briefly push the button again back or pull on it.
To completely close the roof deflector:	E	Briefly push the switch up (arrow).
To set the intermediate position:	D or E	Holding the button or hold it back until the roof is in the required position.

The panorama sliding sunroof will only work with the ignition on. The sliding sunroof can be operated for up to about ten minutes after the ignition has been switched off, provided the driver door and the front passenger door are not opened.

Opening or closing the sunshade

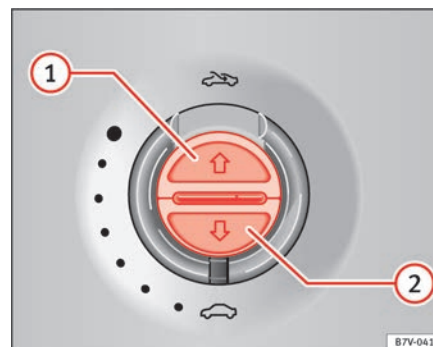

Fig. 60 On the interior roof lining: switches for the sunshade.

Function	Necessary operations
To open completely (automatic):	Press the button ⇒ fig. 60 1 briefly.
To stop automatic operation:	Press the button ⇒ fig. 60 1 or ⇒ fig. 60 2 .
To set the intermediate position:	Hold the button ⇒ fig. 60 1 or ⇒ fig. 60 2 until the required position is reached.
To close completely (automatic):	Press the button ⇒ fig. 60 2 briefly.

The sliding sunroof can be operated for up to about ten minutes after the ignition has been switched off, provided the driver door and the front passenger door are not opened.

Panorama sliding sunroof: operation

Convenience open/close function

The panorama sliding sunroof can be opened or closed from outside the vehicle using the vehicle key:

- Hold in the unlocking for locking button for the vehicle. The panorama sliding sunroof is adjusted or closes.
- Release the unlock or lock button to stop the function.

During convenience closing, first the windows and then the sliding sunroof will be closed.



Note

The sliding sunroof rotary button remains in the last position selected if the roof is closed using convenience closing from outside the vehicle and will have to be re-positioned the next time you drive.

Anti-trap function of the panorama sliding sunroof and the sunshade

The anti-trap function reduces the risk of injury when opening and closing the panorama sliding sunroof and sunshade ⇒ . When the panorama sliding sunroof or the sunshade encounter difficulty or an obstacle when closing, they will stop and reopen.

- Check why the panorama sliding sunroof or the sunshade did not close.
- Attempt to close the panorama sliding sunroof or sunshade once again.
- If the panorama sliding sunroof or sunshade is still obstructed, it will stop at the corresponding position. Now close the panorama sliding sunroof or sunshade without the anti-trap function.

Closing without the roll-back function

- The ⇒ fig. 58 switch should be in the “closed” position .
- *Panorama sliding sunroof*: Within five seconds of triggering the anti-trap function, pull the control all the way back ⇒ fig. 59 (arrow E) until the panorama sliding sunroof closes fully.
- *Sunshade*: Within five seconds of triggering the anti-trap function, push the ⇒ fig. 60 button until the sunshade closes completely.
- **The panorama sliding sunroof or sunshade close without the anti-trap function.**
- If the panorama sliding sunroof still cannot be closed, visited a specialised workshop.



WARNING

Closing the panorama sliding sunroof or sunshade without the anti-trap function can cause serious injuries.

- **Always close the panorama sliding sunroof carefully.**
- **Nobody should be in the way of the panorama sliding sunroof or sunshade, especially when they are closed without the anti-trap function.**
- **The anti-trap function does not prevent fingers or other parts of the body getting pinched against the window frame and causing injury.**



Note

The anti-trap function is activated if the windows and the panorama sliding sunroof are closed from the outside of the vehicle using the ignition key for convenience closing ⇒ page 90.

Lights and visibility

Lights

Introduction

The legal requirements regarding the use of vehicle lights in each country must be observed.

The driver is personally responsible for the correct use and adjustment of the lights in all situations.

Additional information and warnings:

- SEAT information system ⇒ page 62
- Changing bulbs ⇒ page 326









WARNING

If the headlights are set too high and the main beam is not used correctly, there is a risk of dazzling or distracting other road users. This could result in serious accident.

- Always make sure that the headlamps are correctly adjusted.
- Never use the main beam or flashed headlamps as this could dazzle other drivers.

Warning lamps

lights up	Possible cause	Solution
	Driving light totally or partially faulty.	Replace the corresponding bulb ⇒ page 326. If all the bulbs are OK, the vehicle should be taken to a specialised workshop if necessary.
	Fault in adaptive light.	⇒ page 99.
	Rear fog light switched on.	⇒ page 98.
	Fog lights switched on	
	Left or right turn signal. The warning lamp flashes twice as fast when a vehicle or trailer turn signal is faulty.	If necessary, check the vehicle and trailer lighting.
		Headlight on or flasher on.
	Headlight adjustment (Light Assist) on.	⇒ page 98.
flashes	Possible cause	Solution
	Fault in the adaptive light system.	Contact a specialist workshop ⇒ page 98.

Several warning and control lamps should light up for a few seconds when the ignition is switched. This signals that the lamp is working properly. They will switch off after a few seconds.

WARNING

If the warning lamps and messages are ignored, the vehicle may stall in traffic, or may cause accidents and severe injuries.

- Never ignore the warning lamps or text messages.
- Stop the vehicle safely as soon as possible.
- Park the vehicle at a suitable distance away from the traffic ensuring that the exhaust system is not in contact with inflammable material, for example, dry grass, fuel, oil, etc.
- A faulty vehicle represents a risk of accident for the driver and for other road users. If necessary, switch on the hazard warning lamps and put out the warning triangle to advise other drivers.

CAUTION

Failure to heed the warning lamps and text messages when they appear may result in faults in the vehicle.

Turn signal and main beam lever

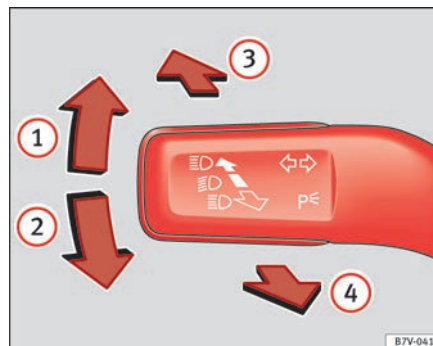





Fig. 61 Turn signal and main beam lever.

■ Move the lever to the required position:

- ① Right turn signal. Right-hand parking light (ignition switched off) ⇒ page 98.
- ② Left turn signal. Left-hand parking light (ignition switched off) ⇒ page 98.
- ③ Main beam switched on ⇒ . The indicator lamp  will light up on the instrument panel.
- ④ Flashing the headlamps. The *flashed beam* comes on if the lever is pressed. The indicator lamp  will light up.

Push the lever all the way down to turn off the corresponding function.

Convenience indicators

For the convenience turn signals, move the lever as far as possible upwards or downwards and release the lever. The turn signal will flash three times. ►

The control turn signals are switched on and off from the menu **Lights & Visibility** on the instrument panel display ⇒ page 62. This function can be disconnected at a specialised workshop for those vehicles which do not have the menu **Lights & Visibility**.



WARNING

Incorrect use of the headlamps may cause accidents and serious injury, as the main beam may distract or dazzle other drivers.



Note

- The turn signal only works when the ignition is switched on. The hazard warning lights also work when the ignition is switched off ⇒ page 312.
- If a turn signal on the vehicle or trailer is faulty, the warning lamp flashes twice as fast as usual.
- The *main beam headlights* can only be switched on if the dipped beam headlights are already on.

Turning lights on and off

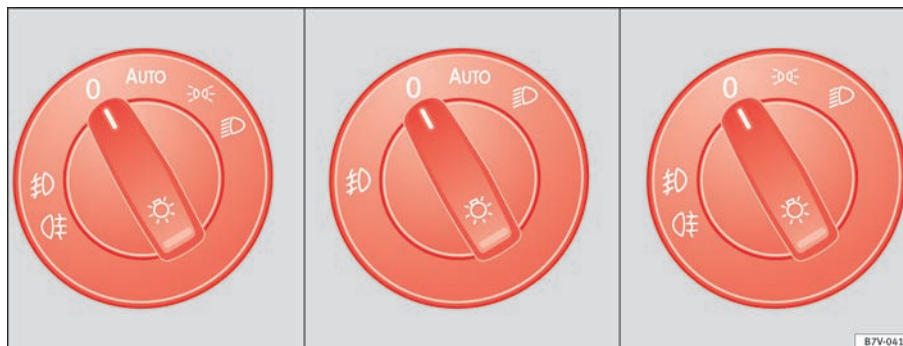



Fig. 62 Next to the steering wheel: diagram of some of the types of light switch.



The legal requirements regarding the use of vehicle lights in each country must be observed.







In vehicles with **tow bar** fitted as standard: If the trailer is connected electrically and is fitted with a rear fog light, this is automatically switched off on the vehicle.

Turn the light switch to the required position ⇒ fig. 62:

	if the ignition is switched off	when the ignition is on
0	Fog lights, dipped beam and side lights off.	Lights off or daytime driving light on.
AUTO	The guidance lights may be switched on.	Automatic dipped beam control or daytime driving light on.
	Side light on.	Side light on.
	Dipped beam off; if necessary, the side light comes on for a time.	Dipped beam switched on.

Fog lights

The warning lamps  or  on the light switch also indicate that the fog lights are switched on.

- Switching on the fog lights : Turn the switch to position  or pull out  to the first stop.
- Switching on the rear fog light : turn the light switch to position  or pull out  to the maximum.
- To switch off the fog lights, press the light switch or turn it to position **0**.

Audible warnings to advise the driver that the lights have not been switched off

If the key is not in the ignition and the driver's door is open, an audible warning signal is heard in the following cases: This is a reminder to turn off the lights.

- When the parking light is on ⇒ page 96.
- When the light switch is in position .

WARNING

The side lights or daytime driving lights are not bright enough to illuminate the road ahead and to ensure that other road users are able to see you.

- Always use your dipped beam head lights if it is raining or if visibility is poor.

Lights and visibility: functions

Parking light

When the parking light is switched on, (right or left turn signal), the front side light and the rear light on the corresponding side of the vehicle stay lit. The parking lights will only work with the ignition off.

Daytime driving light

The daytime driving light consists of individual lights in the front head-lamps.

When the daytime driving light is switched on, only the individual lights come on ⇒ .

The daytime lights are switched on each time the ignition is turned on if the light switch is in position **AUTO**.

When the light switch is in position **AUTO**, a photo sensor automatically turns the instrument and switch lighting on and off.

Activating the daytime lights

Press and hold the turn signal and main beam lever *upwards* and backwards (right turn signal and light flasher).

Deactivating the daytime lights

Press and hold the turn signal and main beam lever *downwards* and backwards (left turn signal and light flasher).

Switch the ignition on and off for approximately 3 seconds. ▶

Automatic dipped beam control(AUTO)

The automatic dipped beam control is merely intended as an aid and is not able to recognise all driving situations.

When the light switch is in position **AUTO**, the vehicle lights and the instrument panel and switch lighting switch on and off automatically in the following situations ⇒ ⚠:

Automatic switching on:	Automatic switching off or switch to daytime lighting:
The photo sensor detects <i>darkness</i> , for example, when driving through a tunnel.	When adequate lighting is detected.
When driving at more than 140 km/h for a few seconds.	When driving at less than 65 km/h for a few minutes.
The rain sensor detects rain and activates the windscreen wipers.	When the windscreen wiper has been inactive for a few minutes.

Adaptive headlights (AFS)

The adaptive headlights only operate when the dipped beam is on and at speeds of over 10 km/h. When taking a bend, the adaptive headlights automatically light up the road better.

The adaptive headlights can be switched on and off from the infotainment system.

Static turning lights

When turning slowly to change direction or going round a tight bend, the static cornering lights automatically come on. The static cornering lights only work at speeds of less than 40 km/h.

The static cornering lights may be incorporated into the fog lights or the front headlights, depending upon the equipment.



WARNING

If the road is not well lit and other road users cannot see the vehicle well enough or at all, accidents may occur.

- The automatic dipped beam control (AUTO) only switches on the dipped beam when there are no changes in brightness, and not, for example when it is foggy.
- Never drive with daytime lights if the road is not well lit due to weather or lighting conditions. Daytime lights do not provide enough light to illuminate the road properly or be seen by other road users.

Headlight adjustment

Headlight adjustment (Light Assist)

The headlight adjustment automatically connects and disconnects the main beam headlights depending on the environmental and traffic conditions and on the speed, within the limitations of the system ⇒ ⚠. This is monitored by a sensor located on the inside of the windscreen, above the interior rear vision mirror.

The automatic headlight adjustment automatically switches on the main beam depending on the vehicles travelling in front and in the opposite direction, and of other environmental and traffic conditions from an approximate speed of 60 km/h (37 mph) and turns them off again at speeds below approximately 30 km/h (18 mph).

Switching on and off

	How it works
Switching on:	– With the ignition on, turn the lights control to the position AUTO and put the turn signal and main beam lever in the main beam position ⇒ page 96. When the headlight adjustment (automatic also) is activated, the warning lamp lights up in the instrument panel display  .
Switching off:	– Disconnect the on button. – OR: turn the lights control to a different position to AUTO ⇒ page 97. – OR: place the turn signal and main beam lever in the headlight flasher or main beam position ⇒ page 96.

The following conditions can cause the headlight adjustment to fail to turn off the main beam or fail to do so in time:

- On roads with insufficient lighting with very reflective signs
- If road users are insufficiently lit up, e.g. pedestrians or cyclists
- On closed curves, when the traffic in the opposite direction is partially hidden, on pronounced slopes
- On roads with traffic in the opposite direction and with a central reservation barrier when the driver can see through gaps or over it e.g. lorry drivers
- If the camera is damaged or if the power supply has been cut off
- In the event of fog, snow or heavy rain
- In the event of dust or sand storms
- If the windscreen is damaged by the impact from a stone in the camera's field of vision
- If the camera's field of vision is misted up, dirty or covered by a sticker, snow or ice.



WARNING

The greater comfort that the headlight adjustment provides (automatic also) must not cause you to take risks. The system is not a replacement for driver awareness.

- Always monitor the lights yourself and adjust them depending on the light, visibility and traffic conditions.
- The headlight adjustment (automatic also) may not correctly detect all situations and in certain situations may only provide limited function.
- If the windscreen is damaged or modifications are made to the vehicle lighting, this may harm the functioning of the headlight adjustment (automatic also), for example, if additional headlight are fitted.



Note

Main beam and flashed headlights can be turned on and off manually at any time with the turn signal and main beam lever ⇒ page 96. ■

Adhesive strips for headlights or adjusting headlights

In those countries where vehicles drive on the other side of the road to the home country, the asymmetric dipped beam may dazzle drivers of oncoming vehicles. Therefore, when driving abroad, adhesive strips should be attached to the headlights or the headlights should be adjusted accordingly.

The direction of the headlights can be adjusted from the instrument panel, in the **Tourist light** submenu of the **Configuration** menu ⇒ page 67.

For those vehicles in which it is not possible to adjust the headlights from the menu, adhesive strips are used to cover certain parts of the headlamp cover or the headlights may be adjusted at a specialised workshop. For further information, please refer to a specialised workshop. SEAT recommends visiting a Technical Service. ►

i Note

Use of the **Tourist light** option and the adhesives on the headlights is only allowed if they are to be used for a short period of time. To modify the direction of the headlights permanently, please take the vehicle to a specialised workshop. SEAT recommends visiting a Technical Service. ■

“Coming home” and “Leaving home” function (guidance lights)

The “Coming home” function should be switched on manually. However the “Leaving home” function is automatically controlled by a photo sensor.

“Coming Home”	Necessary operations
To switch system on:	<ul style="list-style-type: none"> – Switch off the ignition. – Briefly flash the headlights <i>for approximately one second</i> ⇒ page 96. The “Coming home” lighting comes on when the driver’s door is opened. The <i>delay in switching off the headlights</i> is counted from when the last door or tailgate is closed.
The system switches off:	<ul style="list-style-type: none"> – Automatically at the end of the delay period. – Automatically, if 30 seconds after coming on, a vehicle door or tailgate remains open. – If the light switch is turned to position 0. – If the ignition is switched on.
“Leaving home”	Necessary operations
To switch system on:	<ul style="list-style-type: none"> – Unlock the vehicle when the light switch is in position AUTO and the photo sensor detects <i>darkness</i>.
The system switches off:	<ul style="list-style-type: none"> – Automatically, at the end of the delay period. – When the vehicle is locked. – When the light switch is turned to position 0. – When the ignition is switched on.

Lighting around the exterior mirrors

The lighting around the exterior mirrors illuminates the door area on entering and leaving the vehicles. It comes on when the vehicle is unlocked, when the vehicle door is opened and when the “Coming home” or “Leaving home” function is switched on. If the equipment includes the light sensor, the lighting around the exterior mirrors only comes when it is dark.

i Note

- The time taken for the headlights to go off can be changed in the **Lights & Visibility** menu and the function can be switched on or off ⇒ page 62.
- When the “Coming home” function is on, if the vehicle door is opened there is no audible warning signal to advise that the light is still on. ■

Headlight range control, instrument and switch lighting

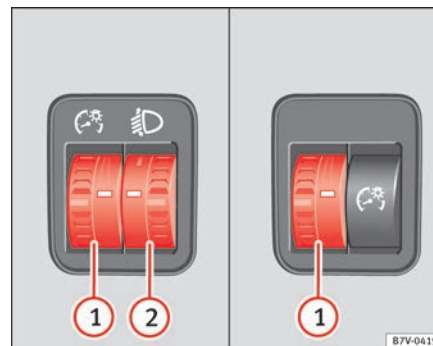

Fig. 63 Next to the steering wheel: instrument and switch lighting control ① and headlight range control ②. ▶

① Instrument and switch lighting

When the headlights are switched on, the brightness of the instruments and switch lighting can be regulated to suit your requirements by turning the switch ⇒ fig. 63 ①.

② Headlight range control

The headlight range control ② is modified according to the value of the headlight beam and the vehicle load status. This offers the driver optimum visibility and the headlights do not dazzle oncoming drivers ⇒ ⚠.

The headlights can only be adjusted when the dipped beam is switched on.

To reset, turn switch ②:

Value	Vehicle load status ^{a)}
–	Two front occupants, luggage compartment empty
1	All seats occupied, luggage compartment empty
2	All seats occupied, luggage compartment full. With trailer and minimum support load
3	Driver only, luggage compartment full. With trailer and maximum support load

^{a)} If the vehicle load does not correspond to those shown in the table, it is possible to select intermediary positions.

Dynamic headlight range control





The control ② is not mounted in vehicles with dynamic headlight range control. The headlight range is automatically adjusted according to the vehicle load status when the headlights are switched on.

WARNING

Heavy objects in the vehicle may mean that the headlights dazzle and distract other drivers. This could result in serious accident.

- **Adjust the light beam to the vehicle load status so that it does not blind other drivers.**

Interior and reading lights

Button / Switch	Function
	Switches interior lights off.
	Switches interior lights on.
	Switches door contact control on (central position). The interior lights come on automatically when the vehicle is unlocked, a door is opened or the key is removed from the ignition. The lights go off a few seconds after all the doors are closed, the vehicle is locked or the ignition is switched on.
	Turning the reading light on and off

Storage and luggage compartment lighting

When the glove box and the tailgate are opened and closed, a light automatically switches on or off.

Ambient lighting

The background lighting in the front covering of the ceiling lights up the controls on the central console from above when the side or dipped lights are on.

In addition, the lever on the door moulding can also be illuminated.

Note

The reading lights go out when the vehicle is locked, or a few minutes after the key is removed from the ignition. This prevents the battery from discharging.

Sun blind

Introduction



WARNING

Sun visors and sun blinds may reduce visibility when open.

- Always roll or fold sun blinds and visors away when not in use.

Sun visors

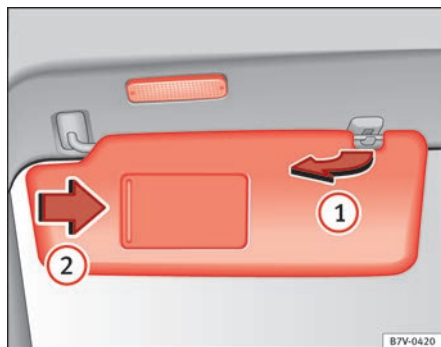

Fig. 64 Sun visor.

Options for adjusting driver and front passenger sun visors:

- Lower by unfolding towards the windscreen.
- The sun visor can be pulled out of its mounting and turned towards the door => fig. 64 ①.
- Swing the sun visor towards the door, longitudinally backwards.

Make-up mirror light

There may be a make-up mirror, with a cover, on the rear of the sun visor. When the cover is opened ② a light comes on.

The lamp goes out when the make-up mirror cover is closed or the sun visor is pushed back up.



Note

The light above the sun visor automatically switches off after a few minutes in certain conditions. This prevents the battery from discharging.

Rear side window sun blinds

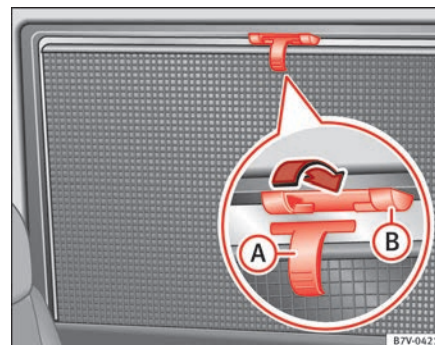

Fig. 65 On the rear right-hand window: sun blind.

The sun blinds for the passenger compartment are fitted in the side panels of the windows.

- Pull the sun blind by the handle ⇒ fig. 65 **A** up to the top.
- Hook both rings of the fastening rod in the spaces provided **B**. Check that the sun blind is securely hooked into the spaces provided when it has been lowered **B**.
- To put the sun blind away, unhook it at the top and lower by hand ⇒ **1**.

**CAUTION**

To prevent damage to the blind or the interior trim, do not lower the sun blind “quickly”.



Windscreen wiper and washer

Introduction

Additional information and warnings:

- Recirculation of air conditioning air ⇒ page 155
- Working in the engine compartment ⇒ page 275
- Caring for and cleaning the vehicle exterior ⇒ page 242

WARNING

Water from the windscreen washer water bottle may freeze on the windscreen if it does not contain enough anti-freeze, reducing forward visibility.

- In winter, ensure the windscreen washer contains enough anti-freeze.
- In cold conditions, you should not use the wash / wipe system unless you have warmed the windscreen with the ventilation system. The anti-freeze could freeze on the windscreen and reduce visibility.

WARNING

Worn or dirty wiper blades reduce visibility and increase the risk of accident and serious injury.

- Always replace damaged or worn blades or blades which do not clean the windscreen correctly.

CAUTION

In icy conditions, always check that the wiper blades are not frozen to the glass **before** using the wipers for the first time. In cold weather, it may help to leave the vehicle parked with the wipers in service position ⇒ page 107. ■

Control lamp

lights up	Possible cause	Solution
	Windscreen wiper fluid level too low	Top up the windscreen wiper bottle as soon as possible ⇒ page 109.

Several warning and control lamps should light up for a few seconds when the ignition is switched. This signals that the lamp is working properly. They will switch off after a few seconds.

CAUTION

Failure to heed the warning lamps and text messages when they appear may result in faults in the vehicle. ■

Windscreen wiper lever

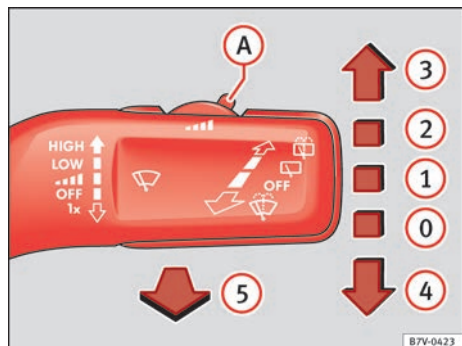

Fig. 66 Using the windscreen wipers.

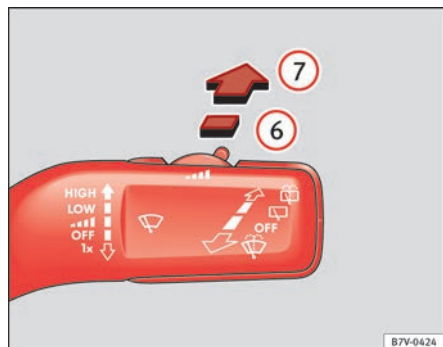

Fig. 67 Using the rear window wipers.

Move the lever to the required position ⇒ ⓘ:

0	OFF	Windscreen wiper off.
1		Intermittent windscreen wipers wipe. Using the control ⇒ fig. 66 (A) adjust the interval (vehicles without the rain sensor), or the sensitivity of the rain sensor.
2	LOW	Slow wipe.
3	HIGH	Continuous wipe.
4		Brief wipe - short wipe. Hold the lever down for more time to increase the wipe frequency.
5		Automatic wipe for cleaning windscreens with the lever up.
6		Intermittent wipe for rear window. The rear wiper will wipe the window approximately every 6 seconds.
7		Automatic wipe for cleaning rear windows with the lever pressed.

! CAUTION

If the ignition is switched off while the windscreen wipers are on, the windscreen wipers carry on wiping at the same level when the ignition is switched back on. Ice, snow and other obstacles may damage the windscreen wiper and the wiper motor.

i Note

- The windscreen wipers will only function when the ignition is switched on and the bonnet or tailgate are closed.
- The intermittent wiper speed varies according to the vehicle speed. The faster the vehicle is moving, the more often the windscreen is cleaned.
- The rear wiper is automatically switched on when the windscreen wiper is connected and the car is in reverse gear.

Windscreen wiper functions

Windscreen wiper performance in different situations:

If the vehicle is at a standstill:	The activated position provisionally changes to the previous position.
During the automatic wipe:	The air conditioning comes on for approximately 30 seconds in air recirculation mode to prevent the smell of the windscreen washer fluid entering the inside of the vehicle.
For the intermittent wipe:	The intervals between wipes vary according to the speed of the vehicle. The higher the vehicle speed the shorter the intervals.

Heated windscreen washer jets

The heating only thaws the frozen jets, it does not thaw the water in the washer hoses. The heated windscreen washer jets automatically adjust the heat depending on the ambient temperature, when the ignition is switched on.

Headlight wash /wipe system

The headlight washers/wipers clean the headlight lenses.

After the ignition is switched on, the first and every fifth time the windscreen washer is switched on, the headlights are also washed. Therefore, the windscreen wiper lever should be pulled towards the steering wheel when the dipped beam or main beam are on. Any incrusted dirt (such as insects) should be cleaned regularly (e.g. when refuelling).

To ensure the headlight washers work correctly in winter, any snow which has got into the bumper jet supports should be cleaned away. If necessary, remove snow with an anti-icing spray.

Note

The wiper will try to wipe away any obstacles that are on the windscreen. The wiper will stop moving if the obstacle blocks its path. Remove the obstacle and switch the wiper back on again.

Windscreen wipers service position

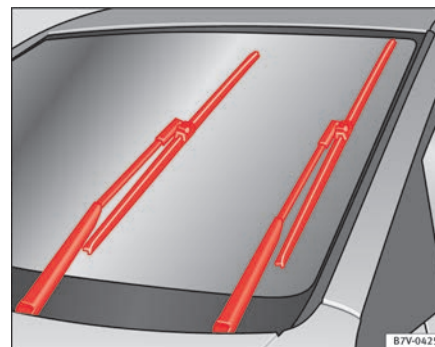

Fig. 68 Wipers in service position.

The wiper arms can be raised when the wipers are in service position ⇒ fig. 68. To place the windscreen wipers in the service position, proceed as follows:

- The bonnet must be closed ⇒ page 275.
- Switching the ignition on and off.
- Press the windscreen wiper lever downwards briefly ⇒ fig. 66 ④.

Before driving, always lower the wiper arms. Using the windscreen wiper lever, the windscreen wiper arms return to their initial position.

Lifting and returning windscreen wiper arms

- Place the wiper arms in the service position ⇒ ❶.
- Only hold the wiper arms at the point where the blade is fixed.

! CAUTION

- To prevent damage to the bonnet and the wiper arms, only leave them in the service position.
- Before driving, always lower the wiper arms.

Rain sensor*

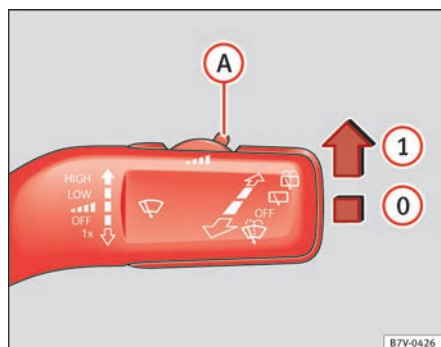

Fig. 69 Windscreen wiper lever: adjusting the rain sensor (A).

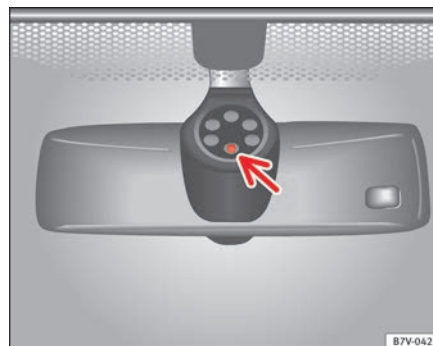

Fig. 70 Rain sensor sensitive surface.

The rain sensor controls the frequency of the windscreen wiper intervals, depending on the amount of rain ⇒ ⚠. The sensitivity of the rain sensor can be adjusted manually. Manual wipe ⇒ page 106

Move the lever to the required position ⇒ fig. 69:

- ❶ Rain sensor off.
- ❶ Rain sensor on; automatic wipe if necessary.
- Ⓐ Setting sensitivity level of rain sensor
 - Set control to the right: highly sensitive.
 - Set control to the left: less sensitive.

When the ignition is switched off and then back on, the rain sensor stays on and starts operating again when the windscreen wipers are in position ❶ and the vehicle is travelling at more than 4 km/h (2 mph).

Rain sensor modified behaviour

Possible causes of faults and mistaken readings *on the sensitive surface* ⇒ fig. 70 of the rain sensor include:

- **Damaged blades:** A film of water on the damaged blades may lengthen the activation time, reduce the washing intervals or result in a fast and continuous wipe.
- **Insects:** insects on the sensor may trigger the windscreen wipers.
- **Salt on roads:** in winter, salt spread in the roads may cause an extra long wipe when the windscreen is almost dry.
- **Dirt:** dry dust, wax, coating on glass (Lotus effect) or traces of detergent (car wash) may reduce the effectiveness of the rain sensor or make it react more slowly, later or not at all.
- **Cracked windscreen:** the impact of a stone will trigger a single wipe cycle with the rain sensor on. Next the rain sensor detects the reduction in the sensitive surface area and adapts accordingly. The behaviour of the sensor will vary with the size of the damage caused by the stone.



WARNING

The rain sensor may not detect enough rain to switch on the wipers.

- If necessary, switch on the wipers manually when water on the windscreen obstructs visibility.



Note

- Clean the sensitive surface of the rain sensor regularly and check the blades for damage ⇒ fig. 70 (arrow).
- To remove wax and coatings, we recommend a window cleaner containing alcohol. ■

Checking and topping up the windscreen washer bottle with water



Fig. 71 In the engine compartment: windscreen washer bottle top.

Check the water level in the windscreen washer bottle regularly and top up as required.

- Open the bonnet ⇒ page 275.
- The washer bottle is marked with the symbol on the lid ⇒ fig. 71.
- Check there is enough water in the bottle.
- To top up, mix water with a window cleaner recommended by SEAT ⇒ . Please follow the instructions for use found on the packaging.
- In cold weather, a special antifreeze should also be added to prevent the water from freezing ⇒ .

Bottle capacity

The bottle holds approximately 3.0 litres; in vehicles with headlight washer, it is approximately 7.0 litres. ►

 **WARNING**

Never mix an unsuitable antifreeze or other similar products with the windscreen washer water. A greasy layer may be formed on the windscreen which will impair visibility.

- Use clean water with a window cleaner recommended by SEAT.
- If necessary, add a suitable antifreeze to the water bottle.

 **CAUTION**

- Do not mix cleaning products recommended by SEAT with other products. This could lead to flocculation and may block the windscreen washer jets.
- When topping up service fluids, make absolutely certain that you fill the fluids into the correct reservoirs. Using the wrong fluids could cause serious malfunctions and engine damage!

Rear vision mirror

Introduction

Additional information and warnings:

- Personal convenience settings in the SEAT information system
⇒ page 62
- Seat memory ⇒ page 117
- Changing gear ⇒ page 174
- Braking, stopping and parking ⇒ page 183

 **WARNING**

The automatic anti-dazzle rear vision mirror contains an electrolytic fluid which may leak if the mirror is broken. This fluid can cause irritation to the skin, eyes and respiratory organs.

- The electrolytic fluid may cause irritation to the skin, eyes and respiratory organs, particularly in individuals suffering from asthma or other illnesses. Make sure that adequate quantities of fresh air enter and leave the vehicle if it is not possible to open all the doors and windows.
- If the electrolytic fluid comes into contact with eyes or skin, wash the area for at least 15 minutes with plenty of water, and seek medical advice.
- If the electrolytic fluid comes into contact with shoes or clothing, wash the area for at least 15 minutes with plenty of water. Wash shoes and clothing before wearing them again.
- If the electrolytic fluid is swallowed, wash the mouth with plenty of water for at least 15 minutes. Do not try to provoke vomiting unless recommended by a Doctor. Seek medical advice immediately.

 **CAUTION**

If an automatic anti-dazzle rear vision mirror is broken, the electrolytic fluid may leak out. This fluid attacks plastic surfaces. Therefore, it should be cleaned as fast as possible with a damp sponge or similar.

Rear vision mirror

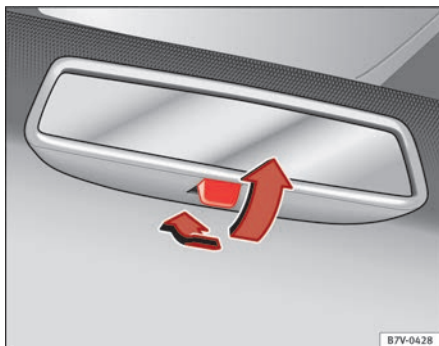

Fig. 72 Manual anti-dazzle function for rear vision mirror

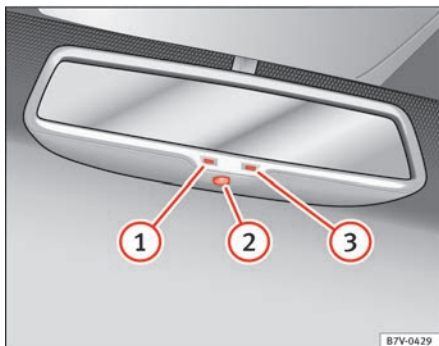

Fig. 73 Automatic anti-dazzle function for rear vision mirror

The driver should always adjust the rear vision mirror to permit adequate visibility through the rear window.

Manual anti-dazzle function for interior mirror

- Basic position: point the lever at the bottom of the mirror forwards.
- Pull the lever to the back to select the anti-dazzle function → fig. 72.

Automatic anti-dazzle function for interior mirror

Legend for the fig. 73:

- ① warning lamp
- ② Control
- ③ Light incidence sensor

This function can be activated and deactivated by pressing the rear vision mirror switch ②. When it is activated, the warning lamp lights up ①.

When the ignition is on, the sensor ③ *automatically* moves the rear vision mirror to the anti-dazzle position depending upon the incidence of the light from behind.

The automatic anti-dazzle function is deactivated when reverse gear is engaged or the interior or reading lights are on.



Note

If the incidence of the light on the sensor is obstructed or prevented, e.g. by the sun blinds, the rear vision mirror with automatic anti-dazzle function will not operate correctly. ■

Exterior mirrors

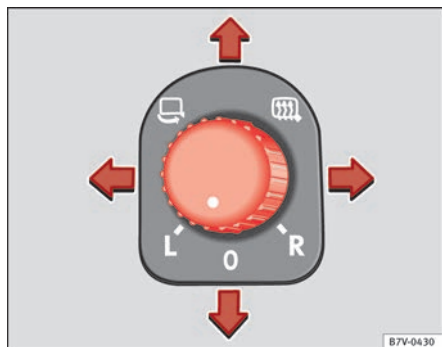



Fig. 74 In the driver door: exterior mirror controls

Turn the knob to the required position:



Electric folding exterior mirrors ⇒ .



Switch on the exterior mirror heating. This only heats up if the ambient temperature is less than +20 °C (+68 °F).

L

Adjust the left-hand exterior mirror by turning the knob forwards, backwards, to the left or to the right.

R

Adjust the right-hand exterior mirror by turning the knob forwards, backwards, to the left or to the right.

0

Zero position. Exterior mirror unfolded, exterior mirror heating off, adjustment of exterior mirror not possible.

Synchronised mirror adjustment

- In the **Settings - Convenience** menu, select whether or not the mirrors should move in synchronisation ⇒ page 62.
- Turn the knob to position **L**.

- Adjust the left-hand exterior mirror. The right exterior mirror will be adjusted at the same time (synchronised).
- If necessary the right exterior mirror adjustment may need correcting. Turn the knob to position **R**.

Automatic anti-dazzle exterior mirror, driver's side

The automatic anti-dazzle exterior mirror is controlled in the same way as the automatic anti-dazzle rear vision mirror ⇒ page 111.

Store the reverse settings for the passenger exterior mirror

- Select the vehicle key in which the setting is to be stored.
- Use this key to unlock the vehicle.
- Connect the automatic parking brake.
- Switch the ignition on.
- Move the gear lever to neutral.
- In the menu **Settings - Convenience** activate the function **Mirror adjustment**.
- Select reverse gear.
- Adjust the front passenger exterior mirror so that you can see, for example, the kerb area.
- The new position of the mirror will be stored automatically and allocated to the vehicle key that was used to unlock the vehicle. For vehicles with seat memory, please see ⇒ page 117.

Activating the passenger exterior mirror settings

- Turn the exterior mirror knob to position **R**.
- With the ignition switched on, select reverse gear.
- The stored position of the passenger exterior mirror for reverse gear is deleted when driving forwards at 15 km/h, or if the knob is turned from position **R** to another position. ►

**WARNING**

Fold and unfold the exterior mirror, taking care to avoid injuries.

- Only fold or unfold the exterior mirror when there is no-one in the way of the mirror.
- When moving the mirror, take care not to trap fingers between the mirror and the mirror bracket.

**WARNING**

Failure to correctly estimate the distance of the vehicle behind could lead to serious accident.

- Rear-view convex or aspheric mirrors increase the field of vision, however objects appear smaller and further away in the mirrors.
- The use of these mirrors to estimate the distance to the next vehicle when changing lane is imprecise and could result in serious accident.
- If possible, use the rear vision mirror to estimate distances to vehicles behind you or in other circumstances.
- Make sure that the rear visibility is adequate.

**CAUTION**

- Before entering a car wash, always ensure that the exterior mirrors are correctly folded in.
- Electrically-folding exterior mirrors should not be folded and unfolded mechanically as this may damage the electrical operation.

**For the sake of the environment**

The exterior mirror heating should be switched off when it is no longer needed. Otherwise, it is an unnecessary fuel waste.

**Note**

- The exterior mirror heating initially heats up with a high power, after two minutes the heat will depend upon the ambient temperature.
- In the event of faults, the electric exterior mirrors can be adjusted manually by pressing the edge of the mirror surface. ■

Seats and storage compartments

Seat adjustment

Mechanical controls on the front seat

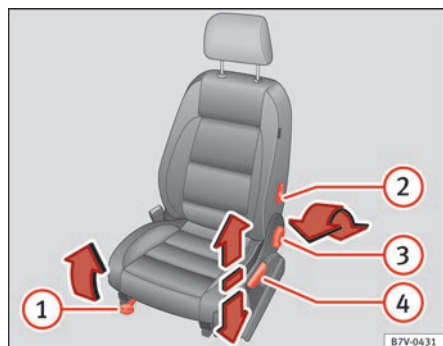

Fig. 75 Front left seat controls.

The controls are mirrored for the front right-hand seat.

Mechanically and electrically adjusted controls can be combined on the seat.

fig. 75	Function	Necessary operations
①	Moving the head restraint backwards or forwards. The front seat must be engaged when the lever is released!	Pull the lever and move the seat forwards. The front seat must be engaged when the lever is released!
②	Adjusting the lumbar support*.	Turn the lever.

fig. 75	Function	Necessary operations
③	Adjusting the backrest angle.	Turn the wheel.
④	Adjusting the seat height.	Pull the lever up or push down (several times if necessary) from its home position.

Electrical controls on the front seat*

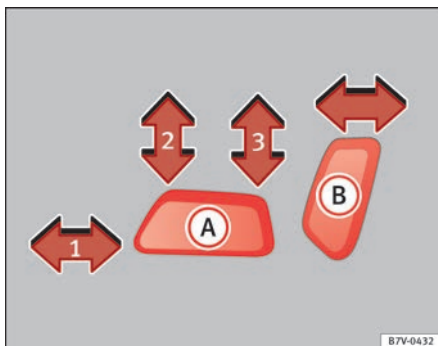

Fig. 76 Adjusting the front left seat forwards or backwards, the height, the seat angle and the front seat backrest.

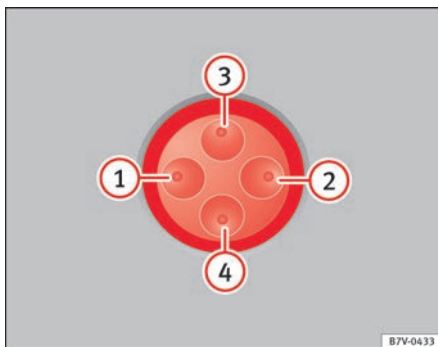

Fig. 77 Adjusting the lumbar support.

The controls are mirrored for the front right-hand seat.

Mechanically and electrically adjusted controls can be combined on the seat.

fig. 76 Press the control in the direction of the arrow:

	①	Move the seat backwards or forwards.
A	② and ③	Raise or lower the seat.
	② or ③	Adjust the seat angle.
B	Forwards or backwards.	Adjust the backrest angle.

fig. 77 Press the corresponding area of the switch:

	① or ②	Adjust the curve of the lumbar support.
	③ or ④	Adjust the height of the lumbar support.

WARNING

Using the front electric seats in a careless or uncontrolled manner may lead to severe injuries.

- The front seats can also be electrically adjusted when the ignition is switched off. Never leave children or disabled people alone in the vehicle.
- In the event of an emergency, stop electrical adjustment by pressing any button.

CAUTION

So as not to damage the electrical components of the front seats, do not kneel on the seats or apply specific pressure to one point of the seat or backrest.

Note

- It may not be possible to electrically adjust the seat if the vehicle battery is very low.
- Seat adjustment is stopped when the engine is started. ■

Adjusting the rear seats



Fig. 78 Adjusting rear seats.

⚠ CAUTION

- Tilting the backrest of the second row of seats fully back could damage the luggage compartment tray. Remove the tray before adjusting the backrest.
- Objects in the luggage compartment could cause damage when moving the rear seats forwards or backwards. ■

⇒ fig. 7 5	Function	Necessary operations
①	Adjusting the backrest angle.	Pull the lever and adjust the backrest to the required position ⇒ ①. The backrest must be engaged when the lever is released! There is a handle instead of the lever on the third row of seats and on the central seat of the second row. It is used in the same manner as the lever.
②	On the second row of seats only: Moving the seat backwards or forwards.	Pull the lever and move the seat forwards or backwards. The seat must be engaged when the lever is released!

Seat functions

Introduction

Additional information and warnings

- Adjust the seat position ⇒ page 10
- Seat belts ⇒ page 21
- Airbag system ⇒ page 31
- Child seats (accessories) ⇒ page 39
- Integrated child seats ⇒ page 45
- Exterior mirrors ⇒ page 110
- Luggage compartment ⇒ page 125



WARNING

Inappropriate use of the seat functions can cause severe injuries.

- **Assume the proper sitting position before your trip and remain in it throughout. This also applies to the other occupants.**
- **Only adjust the seat position memory when the vehicle is stationary.**
- **Only switch the lumbar massage function on and off when the vehicle is stationary.**
- **Keep hands, fingers, feet and other limbs away from the seat operating and adjustment radius.**

Seat heating*



Fig. 79 Detailed view of the centre console: front seat heating controls, here with the second temperature level set.

The seat cushions can be heated electrically when the ignition is switched on. The backrest is also heated in some versions.

Switch off seat heating if there is nobody in the seat.

Function	Action ⇒ fig. 79
To switch system on:	Press button . Seat heating is switched on fully.
Adjusting the heating output:	Keep pressing button until the required intensity is set.
The system switches off:	Keep pressing button until all of the lights are switched off ⇒ fig. 79 .

WARNING

People whose pain and temperature threshold has been affected by some kind of medicine, paraplegia or chronic illness (e.g. diabetes) may sustain burns to the back, buttocks and legs from use of the seat heating that may lead to a long healing process or that may never completely heal. Seek medical advice if you have doubts regarding your health.

- People with a limit pain and temperature threshold must never use seat heating.

CAUTION

- To avoid damaging the heating elements of the seat heating, please do not kneel on the seat or apply sharp pressure at a single point to the seat cushion and backrest.
- Liquids, sharp objects and insulating materials on the seat could damage the seat heating.
- In the event of smells, switch off the seat heating immediately and have the unit inspected by a Technical Service.

For the sake of the environment

The seat heating should remain on only when needed. Otherwise, it is an unnecessary fuel waste.

Seat with position memory*

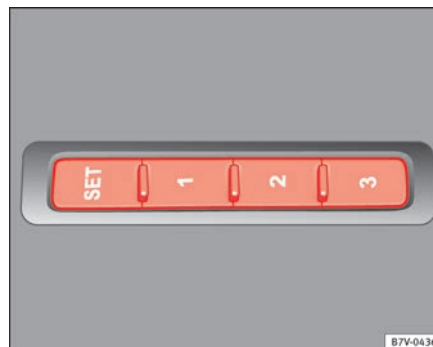

Fig. 80 Memory buttons on the outside of the driver seat

Memory buttons

Individual settings for the driver seat and the exterior mirror can be assigned to each memory button.

Storing exterior mirror settings for driving forwards

- Connect the automatic parking brake.
- Move the gear lever to neutral.
- Switch the ignition on.
- Adjust the front seat and the exterior mirrors.
- Keep the **SET** button held down for more than one second → fig. 80.
- Press the required memory button for the following 10 seconds. A sound confirms the settings have been stored.

Storing front passenger exterior mirror settings for driving in reverse gear

- Connect the automatic parking brake.
- Move the gear lever to neutral.
- Switch the ignition on.

- Press the required memory button.
- Select reverse gear.
- Adjust the front passenger exterior mirror so that you can see, for example, the kerb area.
- The new position of the mirror will be stored automatically and allocated to the vehicle key that was used to unlock the vehicle.

Activating exterior mirror settings

- With the driver's door open and the ignition turned off, push the memory button of the corresponding door briefly.
- **ALTERNATIVELY:** With the ignition switched on, hold in the corresponding memory button until the memorised position is reached.

To activate the memory function of the vehicle key

Important: a position must be memorised in the memory.



- Open the driver-side door.
- Press and hold any memory button.
- Within the following three seconds, push the button  to open the vehicle on the vehicle key. A sound confirms the settings have been activated.

Adjusting the wing mirrors for driving and assigning driver seat settings to a vehicle key

- Activate the memory function of the vehicle key
- Adjust the front seat and the exterior mirrors.
- Lock the vehicle. The settings are assigned to the vehicle key.

To deactivate the memory function of the vehicle key

Important: a position must be memorised in the memory.

- Press and hold the  button.
- Within the following ten seconds, push the button  to open the vehicle on the vehicle key. A sound confirms the settings have been deactivated.

Initialising the seat position memory

The position memory system must be initialised if, for example, the driver's seat has been changed.

Initialisation deletes all memories and assignments for the seat with position memory. The memory buttons can then be reprogrammed and the vehicle keys re-assigned.

- Open the driver's door and do not get into the vehicle.
- Operating the seat settings from outside the vehicle.
- Move the angle of the backrest completely forwards.
- Release the control to set the angle and then press again until a sound is heard.



Note

The front passenger side wing mirror automatically changes from the position stored for reversing as soon as the vehicle moves forward at a speed of at least 15 km/h or when the gear selection lever is changed to a position other than **R**. ■

Convenient entry function for the third row of seats

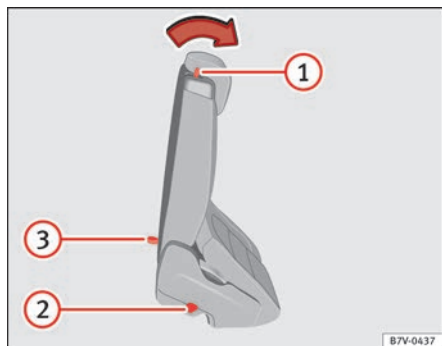

Fig. 81 Second row of seats: convenient entry function controls.

The outer seats of the second row can be folded to make it easier to get in and out of the third row of seats.

Folding down the seat of the second row

- If necessary, open the belt loop and wind up the seat belt by hand.
- If necessary, remove the side head restraint of the integrated child seat ⇒ page 45.
- If necessary, raise the armrests.
- Remove any objects located in the floor area of the second row of seats, where applicable ⇒ ①.
- Push the head restraint down as far as it will go ⇒ page 10.
- Push the lever ⇒ fig. 81 ① forwards and fold the backrest of the rear seat. The seat can still be moved forwards when rear seat is folded completely forwards ⇒ ⚠.
- Always take care when entering and leaving the vehicle ⇒ ⚠.

Repositioning the seat of the second row

- Lift the backrest of the rear seat in an upright position. The entire seat folds backwards ⇒ ⚠.
- Make sure that the rear seat is securely engaged so that the seat belts can provide proper protection in the rear seats. The red mark ② should no longer be visible ⇒ ⚠ in Folding down rear seats to create load space on page 128.

Emergency exit function

If the lever ① does not work, e.g. after an accident, the seats on the second row can be folded forwards from the third row to allow occupants of the third row of seats to get out of the vehicle ⇒ ⚠.

- Pull handle ③ back and fold the backrest of the rear seat. The complete rear seat folds forward ⇒ ⚠.

WARNING

Careless or uncontrolled use of the convenient entry assistant may result in severe injury and accident.

- **Never use the convenient entry function when the vehicle is in motion.**
- **Avoid trapping or damaging the seat belt when folding the rear seats back.**
- **Keep your hands, fingers, feet and other body parts out of the hinges and the seat locking mechanism when folding and unfolding.**
- **Mats or other objects can be caught in the hinges of the backrests or rear seat. This could prevent the backrest from locking safely when positioned upright.**
- **All backrests must engage correctly for the seat belts on the rear seats to work properly. When the backrest of an occupied seat is not correctly locked in place, the passenger can be thrust forward with the backrest in case of sudden braking, sudden manoeuvres or an accident.**

⚠ WARNING (Continued)

- A red mark on the side of the seat ② indicates that the backrest is not engaged. The mark is no longer visible when the backrest is correctly engaged.
- If the backrest or seat are folded down and are not correctly locked in place, no passenger should use them.
- When getting in or out, never lean or hold onto the folded seat on the second row of seats.

⚠ WARNING

If child seats are fitted to all the seats in the second row then it is possible that the seats of this row cannot be folded down from the third row of seats in case of an accident. In case of an emergency, passengers in the third row of seats will not be able to leave the vehicle or to help themselves.

- Child seats should not occupy all the seats of the second row if other passengers are to occupy the third row of seats.

⚠ CAUTION

- Before folding down the rear backrest for returning it to its position, adjust the front seats so that the head restraints and backrests do not hit off each other when folding and unfolding.
- Any objects located in the floor area of the second row of seats may be damaged on folding the rear seat forwards. Remove any objects before folding the seat down.

Folding the backrest of the front passenger seat*

Fig. 82 Folding the backrest of the front passenger's seat.



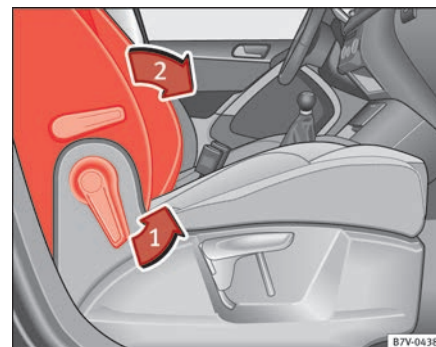

Fig. 83 Unlocking the folding backrest of the front passenger's seat.

The backrest of the front passenger's seat can be folded and locked horizontally.

The front passenger's frontal airbag must be disconnected ⇒ page 31 if objects are being transported on the folded front passenger's seat.

Folding the backrest of the front passenger's seat

- Remove any objects from the front passenger's seat cushion ⇒ .
- Adjust the front passenger's seat to its lowest position ⇒ page 10.
- Push the head restraint down as far as it will go ⇒ page 10.
- Unlock the backrest of the front passenger's seat in the direction of the arrow ⇒ fig. 82 .
- Fold the backrest of the front passenger's seat forwards in the direction of the arrow  until it is horizontal.
- The backrest of the front passenger's seat must engage safely in its folded position.

Lifting the backrest of the front passenger seat

- Check that there are no objects or parts of the body in the hinge area.
- Lift the backrest of the front passenger's seat by first unlocking it again ⇒ fig. 83.
- Lift the backrest of the front passenger seat until it is upright. The backrest must be engaged.
- The upright backrest of the front passenger's seat must safely engage.



WARNING

Folding and lifting the backrest of the front passenger's seat uncontrollably or without paying attention may lead to severe injuries.

- Only fold and lift the backrest of the front passenger's seat when the vehicle is stationary.
- While the backrest of the front passenger's seat is folded, the frontal airbag must remain disconnected and the PASSENGER AIRBAG OFF  light on.



WARNING (Continued)

- Keep your hands, fingers, feet and other body parts out of the hinges and the seat locking mechanism when folding and unfolding.
- Mats or other objects can be caught in the hinges of the backrest of the front passenger's seat. This could prevent the backrest from locking safely when positioned upright.
- The upright backrest of the front passenger's seat must engage. If the backrest of the front passenger's seat is not locked, it may suddenly move and cause severe injuries.



WARNING

Seat anchors and hinges exposed when the backrest of the front passenger's seat is folded may lead to severe injuries in the event of an accident or sudden braking.

- Never carry people or children on the front passenger's seat when the backrest is folded.
- When the backrest of the front passenger's seat is folded, only the outer seat behind the driver on the second row of seats may be occupied. This also applies to children sitting in a child seat.

Head restraints

Adjusting the head restraints

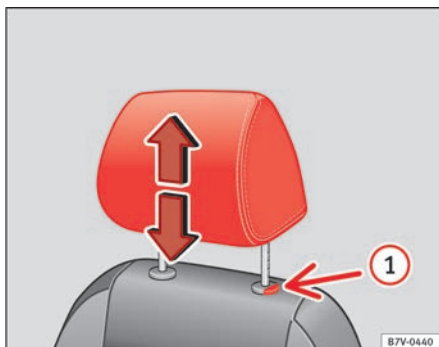

Fig. 84 Adjusting the front head restraints.

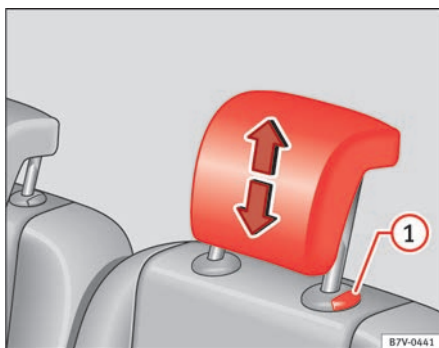

Fig. 85 Adjusting the rear head restraints.

All seats are equipped with a head restraint.

Adjusting height

- Push the head restraint up or down in the direction of the arrow with the button pressed ⇒ fig. 84 ① or ⇒ fig. 85 ① ⇒ ⚠.
- The head restraint must engage securely in position. There are three possible positions on the second row of seats and two possible positions on the third row of seats.

Correct adjustment of head restraints

Adjust the head restraint so that its upper edge is at the same level as the top of your head, or as close as possible to the same level as the top of your head and under no circumstances below eye level. Keep the back of your neck as close as possible to the head restraint.

Adjusting the head restraint for short people

Lower the head restraint completely, even if your head is below its upper edge. When the head restraint is at its lowest, it is possible that a small gap remains between it and the backrest.

Adjusting the head restraint for tall people

Raise the head restraint completely.

⚠ WARNING

Travelling with the head restraints removed or improperly adjusted increases the risk of severe or fatal injuries in the event of accidents and sudden braking or manoeuvres.

- Always fit and adjust the head restraint properly whenever a person is occupying a seat.
- All occupants must correctly adjust the head restraint according to their height to reduce the risk of back injuries in the event of an accident. The upper edge of the head restraint must be as close as possible to the same level as the top of your head and under no circumstances below eye level. Keep the back of your neck as close as possible to the head restraint.
- Never adjust the head restraint while the vehicle is in motion.

Removing and fitting the head restraints

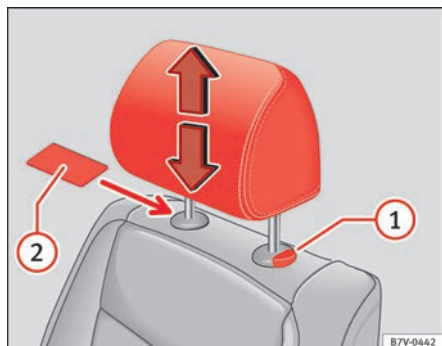

Fig. 86 Removing the front head restraint.

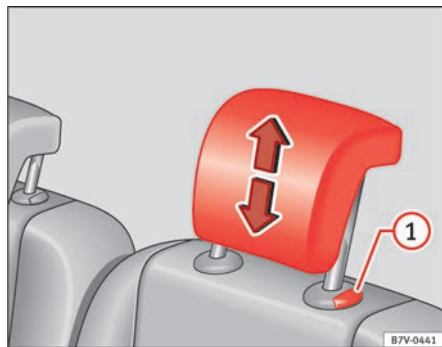



Fig. 87 Removing the rear head restraint.

All seats are equipped with a head restraint.

Removing the front head restraint

- Push the head restraint up as far as it will go ⇒  in Adjusting the head restraints on page 123.
- Unlock the head restraint using a flat object such as a plastic card, if required, sliding it between the upholstery of the head restraint and the head restraint rod-guide cover ⇒ fig. 86 (2).
- Pull the head restraint out of the fitting without releasing the button (1).

Fitting the front head restraint

- Insert the head restraint into the guides on the backrest.
- Push the head restraint down as far as it will go while pressing button (1).
- Adjust the head restraint to the correct position ⇒ page 123.

Removing the head restraints from the second and third row of seats

- Fold the backrest of the rear seat forwards ⇒ page 125.
- Push the head restraint up as far as it will go ⇒ .
- Pull the head restraint out of the fitting without releasing the button ⇒ fig. 87 (1).
- Fold the backrest of the rear seat backwards until it is engaged.

Installing the head restraints for the second and third row of seats

- Fold the backrest of the rear seat forwards ⇒ page 125.
- Insert the head restraint into the guides on the backrest.
- Push the head restraint down as far as it will go while pressing button (1).
- Fold the backrest of the rear seat backwards until it is engaged.
- Adjust the head restraint to the correct position ⇒ page 123. ▶

WARNING

Travelling with the head restraints removed or improperly adjusted increases the risk of severe or fatal injuries in the event of accidents and sudden braking or manoeuvres.

- Always fit and adjust the head restraint properly whenever a person is occupying a seat.
- Refit any removed head restraints immediately so that passengers are properly protected.

CAUTION

On removing and fitting the head restraint, make sure the head restraint does not hit the interior roof of the vehicle or the backrest of the front seat. This could damage the interior roof and other parts of the vehicle. ■

Centre armrest

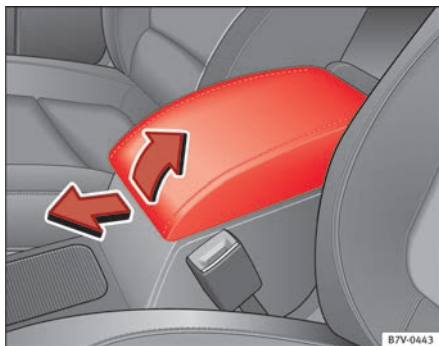

Fig. 88 Front centre armrest.

To *lift* the central armrest, lift it upwards in the direction of the arrow → fig. 88, setting by setting.

To *lower* the centre armrest, pull it downwards. Then lower the centre armrest.

WARNING

The centre armrest may limit the freedom of movement of the driver's arm and cause a serious accident.

- Keep the centre armrest compartments closed while the vehicle is in motion.
- The centre armrest is not designed for children to sit on! Sitting in this incorrect position can cause severe injuries. ■

Loading luggage compartment

Introduction

Always transport heavy loads in the trunk and place the seat backs in a vertical position. Always use the fastening rings with suitable rope or straps. Never overload the vehicle. Both the carrying capacity as well as the distribution of the load in the vehicle have effects on the driving behaviour and braking ability → .

Additional information and warnings:

- Airbag system → page 31
- Light → page 95
- Transporting → page 13
- Towing mode → page 233
- Wheels and tyres → page 293 ▶

 **WARNING**

When the vehicle is not in use or being watched, always lock the doors and the tailgate to reduce the risk of serious injury or death.

- Do not leave children unwatched, especially when the tailgate is open. Children could climb into the luggage compartment, close the tailgate from inside and be unable to escape themselves. This could lead to serious injury or death.
- Never allow children to play in or around the vehicle.
- Never transport people in the luggage compartment.

 **WARNING**

Unsecured or incorrectly secured objects can cause serious injury in case of a sudden manoeuvring or breaking or in case of an accident. This is especially true when objects are struck by a detonating airbag and fired through the vehicle interior. To reduce the risks, please note the following:

- Secure all objects in the vehicle. Always keep equipment and heavy objects in the luggage compartment.
- Always secure objects with suitable rope or straps so that they cannot enter the areas around the frontal or side airbags in case of sudden braking or an accident.
- While driving, always keep object compartments closed.

 **WARNING (Continued)**

- Do not place hard, heavy or sharp objects inside the passenger compartment, in open storage compartments, the rear shelf or on the dashboard.
- Remove hard, heavy and sharp objects from clothes and pockets inside the vehicle and store securely.

 **WARNING**

The transport of heavy object changes vehicle handling and increases braking distance. Heavy loads that have not been stored or secured correctly could cause loss of control and result in serious injury.

- The vehicle handling changes when transporting heavy objects due to a change in the centre of gravity.
- Distribute the load as uniformly and as low down on the vehicle as possible.
- Store heavy objects in the luggage compartment as far from the rear axle as possible.

 **CAUTION**

- Hard objects on the shelf could chafe the wires of the heating element and antenna of the rear window and cause damage.
- The side window antenna could be damaged due to chafing from objects.

 **Note**

The ventilating slits between the heated rear window and the shelf must not be covered so that used air can escape from the vehicle. ■

Folding down rear seats to create load space

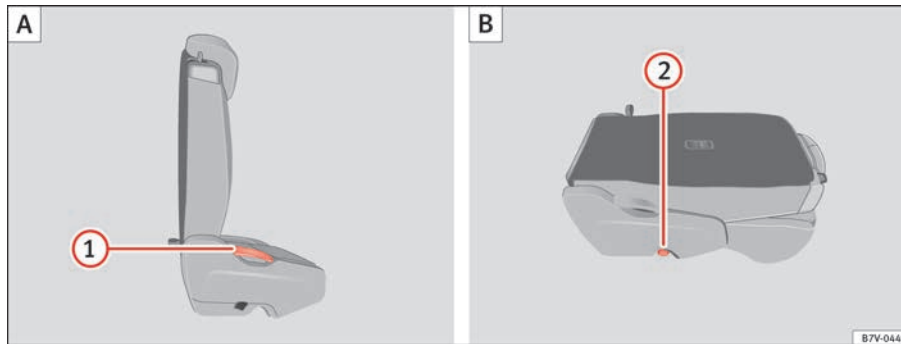

Fig. 89 Second row of seats: folding the rear seat (A), rear seat as load space (B).

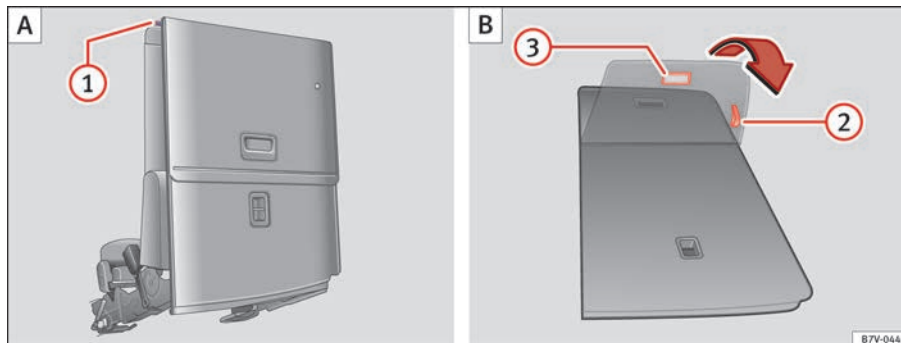

Fig. 90 Third row of seats: fold down the rear seat to load (A) then return to position (B).

Each rear seat can fold down individually to extend the luggage compartment. ▶

Folding the seats in the second row of seats for loading

- If necessary, open the belt loop and wind up the seat belt by hand.
- If it is necessary, remove the head rests on the integrated child seats then reinstall the integrated child seats ⇒ page 45.
- If necessary, raise the armrests.
- Remove objects from the footrest area in front of and behind the rear seat ⇒ ①.
- Move the rear seat all the way back.
- Push the head restraint down as far as it will go ⇒ page 10.
- In the middle seat, close the drinks carrier in the rear of the centre console, if necessary.
- Pull lever ⇒ fig. 89 ① back and fold the backrest forwards. The complete rear seat folds forward ⇒ ⚠.
- Fold the backrest forwards until it locks into the load surface position **B**.
- If necessary, pull on the lever ⇒ fig. 90 ② to move the seat to the required position.
- When the seat is folded down, no adults or children should travel in it ⇒ ⚠.

Folding the seats in the third row of seats for loading

- If necessary, open the belt loop and wind up the seat belt by hand.
- Open the tailgate.
- Push the head restraint down as far as it will go ⇒ page 10.
- Remove objects from the footrest area in front of and behind the rear seat ⇒ ①.
- Remove objects from the space below the rear seat.
- Remove the attachment elements and supports for the net from the rail system.
- Pull lever ① back and fold the backrest forwards. The rear seat folds forward ⇒ ⚠ and the cushion also moves forward.

- Fold the seat tray forward on top of the folded seat.
- When the seat is folded down, no adults or children should travel in it ⇒ ⚠.

Putting the seats in the second row back in place

- Pull lever ⇒ fig. 89 ① upwards and place the backrests in vertical position. The entire seat folds backwards.
- Pull on the rear seats and the backrest to ensure that they are correctly locked in place and that the safety belt protection is guaranteed for rear seat passengers.

Putting the seats in the third row back in place

- Open the tailgate.
- Pull on the handle ⇒ fig. 90 ② to put the seat tray back in position.
- Pull on the handle ③. The entire seat folds backwards.
- Press on the seat tray in the backrest until it is held in position by its magnets.
- Open the sliding door.
- Put the backrest into position and press firmly until it clicks into place.
- Pull on the rear seats and the backrest to ensure that they are correctly locked in place and that the safety belt protection is guaranteed for rear seat passengers.

WARNING

Folding and lifting the rear seats carelessly without paying attention could cause serious injury.

- **Never fold or lift the seats while driving.**
- **Do not trap or damage seat belts when raising the backrest.**
- **Keep your hands, fingers, feet and other body parts out of the hinges and the seat locking mechanism when folding and unfolding.**

 **WARNING (Continued)**

- **Mats or other objects can be caught in the hinges of the backrests or rear seat. This could prevent the seat or backrest from locking securely in the vertical position.**
- **All backrests must engage correctly for the seat belts on the rear seats to work properly. When the backrest of an occupied seat is not correctly locked in place, the passenger can be thrust forward with the backrest in case of sudden braking, sudden manoeuvres or an accident.**
- **No seat must be occupied if the backrest or seat is folded or not correctly engaged.**

**CAUTION**

- Before folding the backrest of the rear seat, adjust the front seats so that the head restraint or backrest do not hit them when it is folded.
- Objects placed in the footrest area in front of and behind the rear seats can be damaged when seats are folded down or put back into position. Remove any objects in the way before folding seats down or repositioning them.

- Objects placed in the moulding on the back of the third row of seats can be damaged when folding down the seats or putting them back into position. Remove any objects in the way before folding seats down or repositioning them.
- The attachment elements and supports for the net partition placed on the rail system can be damaged when folding down seats from the third row or putting them back into position and these can also damage the seats themselves. Before folding down or repositioning the seats, remove the attachment elements and supports for the net from the rail system. ■

Rear shelf*

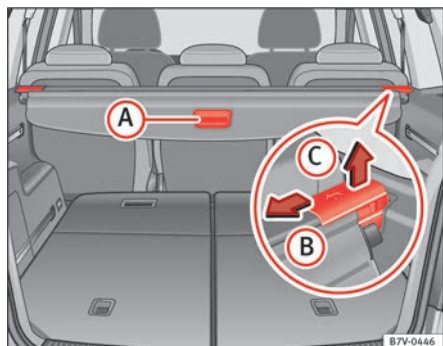

Fig. 91 In the luggage compartment: rear shelf.

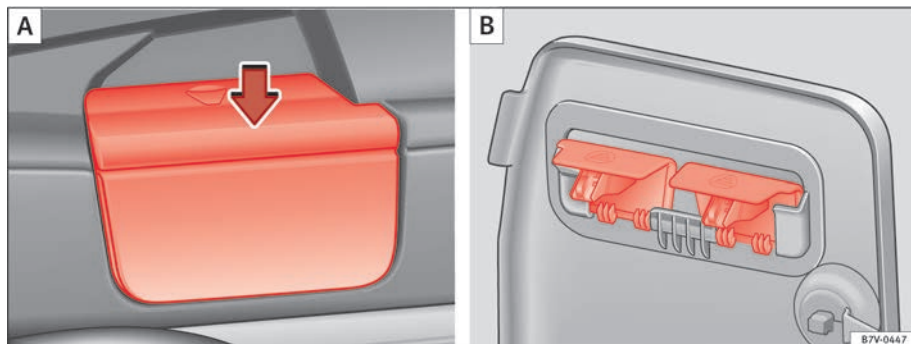

Fig. 92 Remove the shelf supports (A) then put them away safely (B).

The rear shelf can be fitted behind the second or third row of seats ⇒ ⚠.

Opening the shelf

- Pull the shelf handle ⇒ fig. 91 (A) backwards.
- Release the shelf upwards by the side supports and guide it forward. ▶

Closing the shelf

- Pull the unfolded shelf evenly on the guide backwards.
- Secure the shelf using the left and right side supports.

Installing the shelf behind the second row of seats

- Place the shelf in its position in the side lining, left-hand side first.
- Release the shelf in the direction of the arrow **(B)**.
- Insert the shelf into the right-hand support, pressing down.

Installing the shelf behind the third row of seats

- Remove the shelf from the support in the side lining ⇒ fig. 92 **(A)**. To do this, press the shelf upwards (arrow) and remove it.
- Open the compartment in the left-hand side rear lining ⇒ page 141 and hook the shelf to the rear of the luggage compartment cover **(B)**.
- Close the rear left-hand side lining compartment.
- Place the shelf in its position in the side lining, left-hand side first.
- Lift the shelf off in direction of the arrow ⇒ fig. 91 **(B)**.
- Insert the shelf into the right-hand support, pressing down.

Removing the shelf

- Release the shelf in the direction of the arrow **(B)** and lift it in the direction of the arrow **(C)**.
- Remove the shelf from the right-hand side support.

- **Also, when removing from behind the third row of seats:** Cover the side-lining supports with their covers.
- **Only with 5 places:** Support the released shelf by placing it on the front section of the luggage compartment floor ⇒ page 141.



WARNING

If the shelf is placed on one of the rear seats, this could cause serious injury in case of sudden braking or an accident.

- Whenever it the third row seats are occupied, the shelf should be put behind this row.



WARNING

Unsecured or incorrectly secured objects or animals on the rear shelf could cause serious injuries in case of a sudden manoeuvre or braking or even an accident.

- Do not leave hard, heavy or sharp objects (loose or in bags) on the rear shelf.
- Never transport animals on the rear shelf.

Net partition*

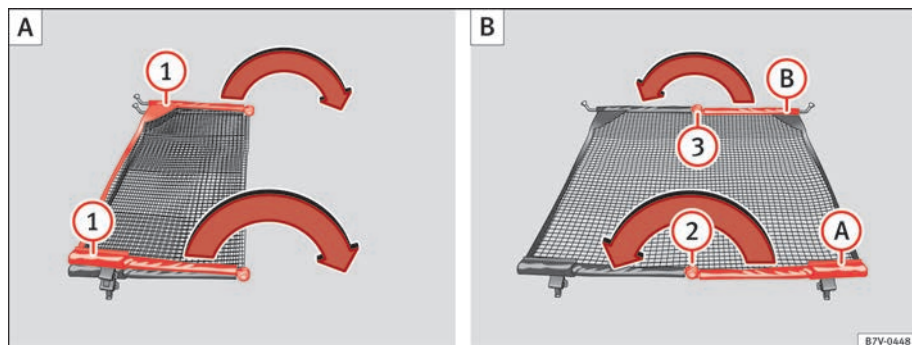

Fig. 93 Unfold the net partition ① then fold it again ② and ③.

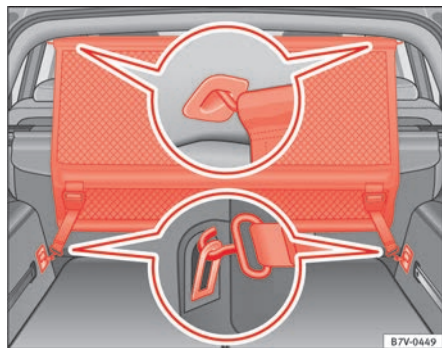

Fig. 94 In the luggage compartment: Install the net partition behind the second row of seats.

Fold out the net partition

Fold out the support transversal rods ⇒ fig. 93 ① for the net partition fully in the direction of the arrow until you hear a “click”.

Installing the net partition behind the second row of seats

- Hook in the net partition on the left-hand side roof support ⇒ fig. 94 ①.
- To do this, guide the rod from up to down.
- Hook in the net partition on the rear right-hand side roof support by pressing on the rod.
- Secure the net partition hooks into the straps in the front of the luggage compartment ② then tighten them. ▶

The net partition can prevent objects in the luggage compartment entering the passenger compartment / the driver area.

First remove the net from its bag and unfold it.

Installing the net partition behind the front seats

- Hook in the net partition on the left-hand side roof support **(C)**. To do this, guide the rod from up to down.
- Hook in the net partition on the rear right-hand side roof support by pressing on the rod.
- Secure the hooks of the net partition to the attachment rings in the left and right hand side foot rests on the second row of seats then tighten the straps.

Removing the net partition

- Loosen the net partition straps.
- Release the net partition hooks from the rings **(B)**.
- Release the net partition from the right and left roof supports **(A)** or **(C)** by pressing on the rod.
- Unhook the net partition from the left-hand side roof support.

Folding in the net partition

- Press on the release button \Rightarrow fig. 93 **(2)** and bend the rod **(A)** in the direction of the arrow with the release button pressed.
- Press on the release button **(3)** and bend the rod **(B)** in the direction of the arrow with the release button pressed.
- Store the net partition securely in the vehicle.

WARNING

Loose objects in the passenger compartment can be violently thrown in case of a sudden manoeuvre or braking and especially in accidents causing serious injury.

- Ensure that the rods are correctly locked in place.
- Even when net partition is correctly fitted, objects must be secured.
- When driving with the net partition, no passengers should be behind it.

Fastening rings*

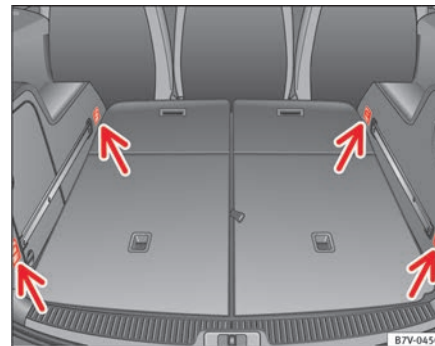

Fig. 95 In the luggage compartment: fastening rings

To the front and rear of the luggage compartment, there are fastening rings for securing objects \Rightarrow fig. 95 (arrows). On some models, the fastening rings are all the way to the back on the lock carrier plate.

There are other fastening rings located to the left and right hand side of the second row footrests.

Some models of fastening rings must be lifted to use them.

WARNING

Unsuitable or damaged ropes or straps may be released in case of sudden braking or an accident. As a result, objects may be fired through the passenger compartment causing serious injury or death.

- Always use suitable ropes and straps in good condition.
- Secure the ropes and straps to the fastening rings.

⚠ WARNING (Continued)

- **Loose objects in the luggage compartment can suddenly slide and change the way the vehicle handles.**
- **Secure all objects, little and large.**
- **Never secure a load that is too heavy for the fastening rings.**
- **Never secure a child seat to the fastening rings.**

**Note**

- The maximum load of the fastening rings is approximately 3.5 Kn (3.57 Kp).
- You can find suitable transport straps and load securing systems at a specialist workshop. SEAT recommends visiting a Technical Service.

Rails and attachment system*

Fig. 96 In the luggage compartment: System including rails, adjustable attachment elements ① and adjustable tightening straps ②.

The rails and attachment system consists of four rails, movable attachment elements, straps to be secured to the rails and a net with supports to cover

baggage ⇒ page 135. The rail and attachment system is designed to secure light objects. If the seats in the third row are to be occupied by passengers then attachment elements should never be placed in the section of the rails close to the seats ⇒ ⚠.

Installing the attachment elements

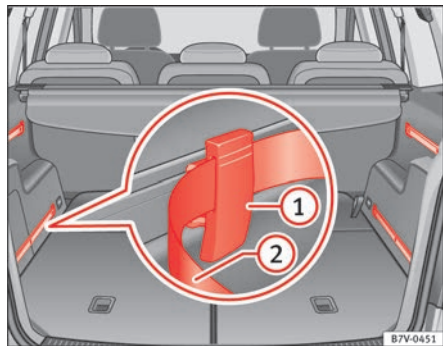
- Fit the attachment element with the ruts facing upwards ⇒ fig. 96 ① to the upper part of the guide and press downwards.
- Move the attachment element to the desired position.
- Always ensure that the attachment inserts into the guide system ⇒ ⚠.

Removing the attachment elements

- Remove the attachment element from the guide and pull downwards.

Securing a load

- Pull the strap through the attachment element and secure the load ⇒ ⚠.

⚠ WARNING

In case of an accident or sudden braking, the attachment elements in the parts of the rails close to the seats of the third row could injure seat occupants.

- **Whenever the seats on the third row are to be occupied, remove the attachment elements from the rails or move them all the way back.**

⚠ WARNING

Movable attachment elements that are not secured correctly can be released from the guide in case of sudden braking or accident. As a result, objects may be fired through the passenger compartment causing serious injury or death.

- **Always ensure that the movable attachment elements are correctly inserted into the guides.**

! **WARNING**

Unsuitable or damaged ropes or straps may be released in case of sudden braking or an accident. As a result, objects may be fired through the passenger compartment causing serious injury or death.

- Always use the attachment straps of the rail and attachment system.
- Secure the attachment straps firmly to the attachment elements.
- Loose objects in the luggage compartment can suddenly slide and change the way the vehicle handles.

! **WARNING (Continued)**

- Secure all objects, little and large.
- Never secure a child seat to the attachment elements.

! **CAUTION**

- The attachment elements placed on the rail system can be damaged when folding down seats from the third row or putting them back into position and these can also damage the seats themselves. Before folding down or repositioning the seats, remove the attachment elements and supports for the net from the rail system.

Baggage net*

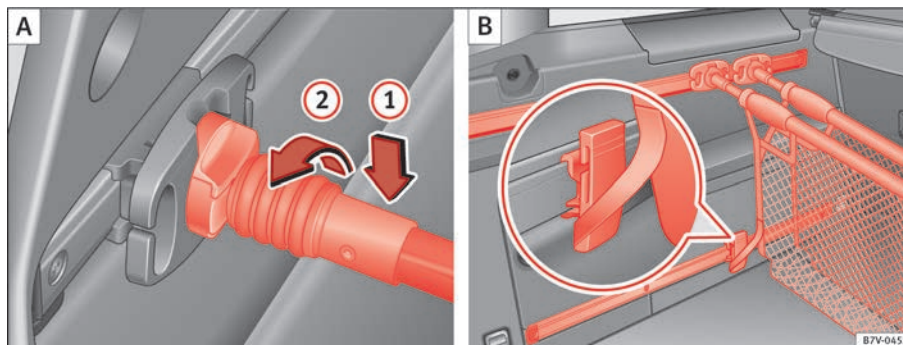

Fig. 97 Hook the baggage net (A) and use it as a bag (B).

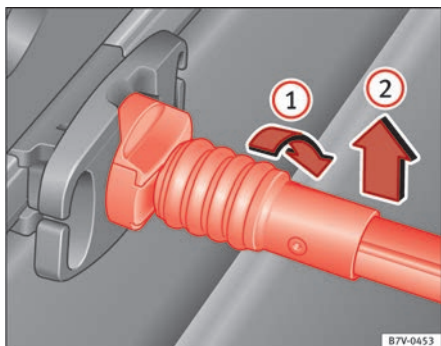

Fig. 98 Release the baggage net.

If the seats in the third row are to be occupied by passengers then attachment elements should never be placed in the section of the rails close to the seats ⇒ ⚠.

Installing the baggage net supports

- Fit the baggage net support into the guide from the back and press downwards.
- Move the baggage net support to the required position.
- Always ensure that the net support inserts into the rail system ⇒ ⚠.

Hooking the baggage net into the support

Place the attachment rod on the baggage net support ⇒ fig. 97 ① and rotate 90° to the left ②. The red mark on the attachment rod should not be visible ⇒ ⚠.

Using the net for bag type baggage

- Fit the baggage net supports to each one of the upper rails.
- Fit a movable baggage net attachment element to each one of the lower guides ⇒ page 134.
- Hook the baggage net into the supports.

- Hook the baggage net attachment strap underneath into one of the movable attachment elements ⑧.
- Join the baggage net supports to the upper rails as much as possible by pushing them.
- Press the sides of the baggage net together so that they are held by the Velcro.

Using the baggage net to separate the luggage compartment

- Fit the baggage net supports to each one of the upper rails.
- Fit the baggage net supports to each one of the lower rails.
- Hook the baggage net into the supports.

To release the baggage net

- Rotate the attachment rod 90° to the right ⇒ fig. 98 ① until you can see the red mark on the rod. Pull the attachment rod upwards ②.
- **Only with 5 places:** After removing, place the baggage net safely in the front compartment on the floor of the luggage compartment ⇒ page 141.

Removing the baggage net supports

- Remove the net attachment element from the rail and pull it out downwards.

⚠ WARNING

In case of an accident or sudden braking, the net attachment elements in the parts of the rails close to the seats of the third row could injure seat occupants.

- **Whenever the seats on the third row are to be occupied, remove the attachment elements from the rails or move them all the way back.**

WARNING

Baggage net supports that are not secured correctly can be released from the guide in case of the sudden braking or accident. As a result, objects may be fired through the passenger compartment causing serious injury or death.

- Always ensure that the baggage net supports are correctly inserted into the rails; the red mark should not be visible.
- Never secure a child seat to the baggage net supports.

CAUTION

- The baggage net supports placed on the rail system can be damaged when folding down seats from the third row or putting them back into position and these can also damage the seats themselves. Before folding down or repositioning the seats, remove the baggage net supports from the rail system.

Retaining hooks

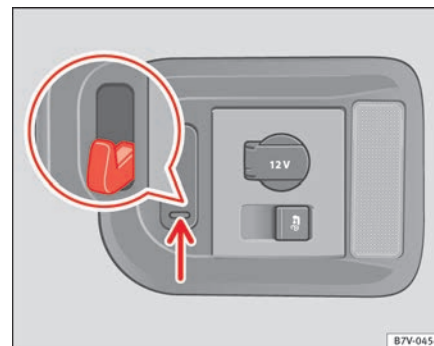

Fig. 99 In the luggage compartment: retaining hooks.

On the right-hand side of the luggage compartment, there are folding retaining hooks ⇒ fig. 99 that can be used to secure light shopping bags.

- Press the retaining hooks down ⇒ fig. 99 (arrow) and fold them.
- Hook the bags in place.
- After use, raise the hooks again.

WARNING

Never use these hooks to secure objects. In case of sudden braking or an accident, the hooks could rupture.

CAUTION

The hooks can support a maximum of 2.5 kg (about 5 lbs).

Luggage net*

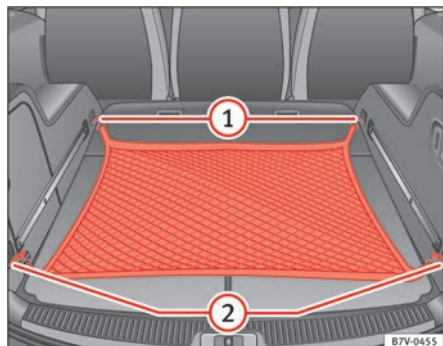

Fig. 100 In the luggage compartment: net used on secured baggage.

The baggage net can be used to secure lighter items.

Hooking the baggage net into the luggage compartment floor

- Hook the baggage net into the fastening rings ⇒ fig. 100 ① and ②.

Releasing the baggage net

The secured baggage net is taut ⇒ ⚠.

- Carefully unhook the baggage net hooks from the fastening rings ①.
- Carefully unhook the baggage net hooks from the fastening rings ②.

⚠ WARNING

The elastic baggage net stretches when it is secured to the luggage compartment fastening rings. The secured baggage net is taut. The hooks on the baggage net can cause injury if the net is incorrectly hooked or unhooked.

- Always ensure that the hooks do not suddenly release from the fastening rings when hooking or unhooking.
- Always keep your face and eyes protected at a safe distance to avoid injury should a hook slip while hooking or unhooking.
- Always engage the hooks in the order given. If a baggage net hook springs back this can cause injury.

Roof carrier system*

Introduction

The vehicle roof has been designed to optimise aerodynamics. For this reason, conventional roof carrier systems cannot be secured to the roof rails.

Given that the water drains have been incorporated into the roof for aerodynamic reasons, only the SEAT approved basic supports and roof carrier systems can be used.

When should the roof carrier system be removed?

- When it is not being used.
- When the vehicle is being washed in a car wash.
- When the vehicle height exceeds the maximum height (for example, in a garage).

Additional information and warnings:

- Light ⇒ page 95
- Transporting ⇒ page 13
- Ecological driving ⇒ page 225
- Wheels and tyres ⇒ page 293
- Accessories, parts replacement, repairs and modifications ⇒ page 257

WARNING

The risk of an accident is increased by transporting heavy or bulky loads on the roof, which affects the car's handling by shifting the centre of gravity and increasing susceptibility to cross winds.

- Always secure loads correctly with suitable and undamaged attachment rope or straps.
- Large, heavy, wide and flat loads negatively affect the vehicle aerodynamics, centre of gravity and handling.
- Avoid brusque manoeuvres and sudden braking.
- Adjust your speed and driving style to visibility, road, traffic and weather conditions.

CAUTION

- Always remove the roof carrier system from the roof before entering a car wash.
- The height of your vehicle is changed by the installation of the roof carrier and the load secured on it. Compare the vehicle height with the passage height, for example in underground car parks or entering garage doors.
- The roof antenna, the range of the panoramic sliding roof and the tailgate should not be affected by the roof carrier system and the load being transported.
- Take extra care not to let the tailgate strike the roof load when opening.

For the sake of the environment

The vehicle uses more fuel when the roof carrier system is fitted. ■

Securing the base supports and roof carrier system

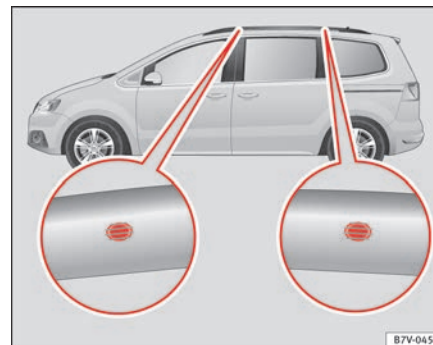

Fig. 101 Attachment points for the basic support and the roof carrier system.

The mounts are the basis of a complete roof carrier system. Special fixtures must then be added in order to safely transport luggage, bicycles, skis, surf boards or boats on the roof. All these system components are available from an Authorised Service Centre.

It will only be possible to install a basic support or roof carrier system if the vehicle has a roof rail.

Securing the base supports and roof carrier system

Always secure the base supports and roof carrier system correctly.

The roof carrier system must always be installed exactly according to the instructions provided. ►

The position holes are located on the inner side of the rail ⇒ fig. 101.

WARNING

If the base supports and the roof carrier system are incorrectly fitted or used in an unsuitable manner, the entire system could break free causing accident and injury.

- Always take the manufacturer assembly instructions into account.
- Only use base supports and roof carrier systems that are not damaged and are correctly fitted.
- The base support should only be fitted to the points indicated in the diagram ⇒ fig. 101.
- Secure the base supports and roof carrier system correctly.
- Check the screw fittings and attachments before driving and after a short distance. During each long journey, check the attachments during every break.
- Always fit the roof carrier system correctly for wheels, skis and surfboards.
- Never change or repair the basic supports or roof carrier system.



Note

Read and take into account the instructions included with the roof carrier system fitted and keep them in the vehicle.

Loading the roof carrier system

Loads can only be correctly secured when the roof carrier system is correctly fitted ⇒ .

Maximum authorised roof load

The maximum authorised roof load is **100 kg (about 220 lbs)**. The roof load includes the roof carrier system and the load being transported ⇒ .

Always check the roof carrier system weight and the weight of the load to be transported and, if necessary, weigh them. Never exceed the maximum authorised roof load.

If you are using a roof carrier with a lower weight rating, you cannot transport the maximum roof load. Do not exceed the maximum weight limit for the roof carrier given in the fitting instructions.

Distributing a load

Uniformly distribute loads and secure them correctly ⇒ .

Check attachments

After fitting the base supports and the roof carrier system, always check the attachments after a short trip or at regular intervals.

WARNING

Exceeding the maximum authorised roof load can result in accidents and/or vehicle damage.

- Always respect the maximum authorised weight for the roof, the maximum authorised weight on the axles and the total maximum authorised weight of the vehicle.
- Never exceed the capacity of the roof carrier system even if this is less than the maximum authorised roof load.
- Secure heavy objects towards the front and distribute the load evenly.

WARNING

Loose and incorrectly secured loads can fall from the roof carrier system causing accidents and injury.

- Always use suitable ropes and straps in good condition.
- Always secure loads correctly.

Storage compartments

Introduction

Storage compartments must only be used to store light or small objects.

The front central armrest compartment houses the factory-fitted **AUX-IN** or **multimedia (MEDIA-IN)** connection sockets.

The factory-fitted **CD changer** is located in the left-hand storage compartment of the luggage compartment.

Additional information and warnings:

- Child seats (accessories) ⇒ page 39
- Luggage compartment ⇒ page 125
- Care and cleaning of the vehicle interior ⇒ page 249
- ⇒ Booklet Radio or ⇒ Booklet navigation system



WARNING

In the event of sudden braking movements or turns, loose objects may be thrown around the vehicle interior. This could cause serious injuries to passengers and cause the driver to lose control of the vehicle.

- **Do not transport animals or place hard, heavy or sharp objects inside the vehicle in: open storage compartments, instrument panel, storage tray, items of clothing or bags.**
- **While driving, always keep object compartments closed.**



WARNING

Objects falling into the driver's footwell could prevent use of the pedals. This could lead the driver to lose control of the vehicle, increasing the risk of a serious accident.

- **Make sure the pedals can be used at all times, with no objects rolling underneath them.**
- **The floor mat should always be secured to the floor.**
- **Never place other mats or rugs on top of the original mat supplied by the factory.**
- **Make sure that no objects can fall into the driver's footwell while the vehicle is in motion.**



CAUTION

- Objects on the shelf could chafe against the wires of the heating element in the rear window and cause damage.
- Do not keep heat-sensitive objects, food or medicines inside the vehicle. Heat and cold could damage them or render them useless.
- Light-transparent objects placed inside the vehicle, such as lenses, magnifying glasses or transparent suction caps on the windows, could concentrate the sun's rays and cause damage to the vehicle.



Note

The ventilating slits between the heated rear window and the shelf must not be covered so that used air can escape from the vehicle. ■

Spectacle case in the roof console

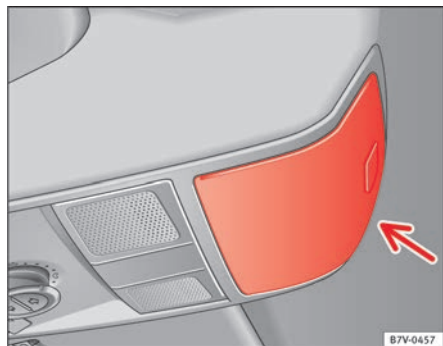

Fig. 102 On the roof console: Sunglasses storage compartment.

To *open*, press and release the button ⇒ fig. 102 (arrow).

To *close*, press the cover upwards until it clicks into place.

To ensure the passenger compartment monitoring works correctly, the spectacle case must be closed when the vehicle is locked ⇒ page 79. ■

Compartment on the instrument panel*

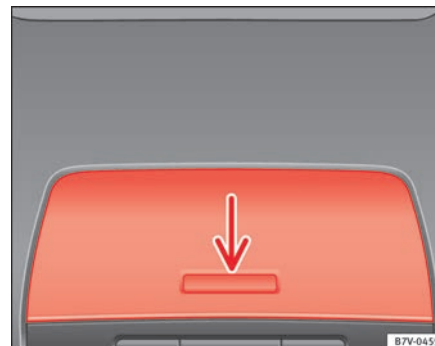

Fig. 103 Storage compartment on the instrument panel.

The storage compartment on the instrument panel may have a cover.

To *open*, press the button on the cover ⇒ fig. 103 (arrow).

To *close*, press the cover down until it clicks into place. ■

Compartment on the centre console



Fig. 104 Compartment in the front centre console.

There is an open compartment on the centre console ⇒ fig. 104 in which there may be a 12 volt socket ⇒ page 151.

Compartment in the front central armrest

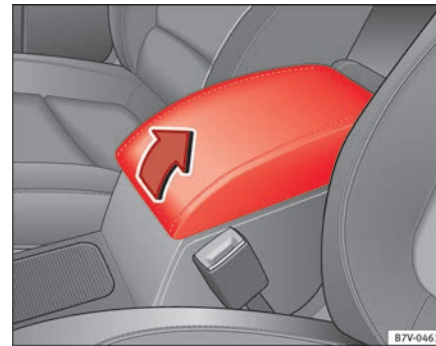

Fig. 105 Storage compartment in the front central armrest.

To *open*, fully lift the central armrest in the direction of the arrow ⇒ fig. 105.

To *close*, lower the central armrest.

WARNING

The centre armrest may limit the freedom of movement of the driver's arm and cause a serious accident.

- Keep the centre armrest compartments closed while the vehicle is in motion.

WARNING

The centre armrest is not designed for children to sit on!

Card compartments*

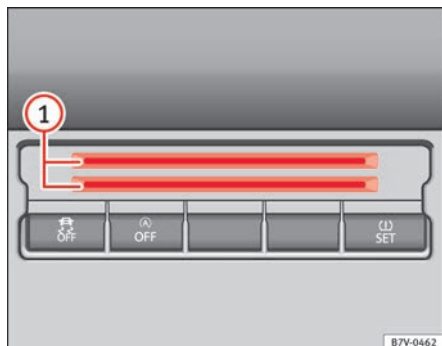

Fig. 106 Centre console, lower section: card compartment.

To the bottom of the centre console there is a compartment ⇒ fig. 106 ① for coins, cards, car park tickets and similar items.

Note

To avoid theft or use by others, do not use the compartment to store credit or ATM cards or similar. ■

Glove compartment



Fig. 107 Glove compartment.

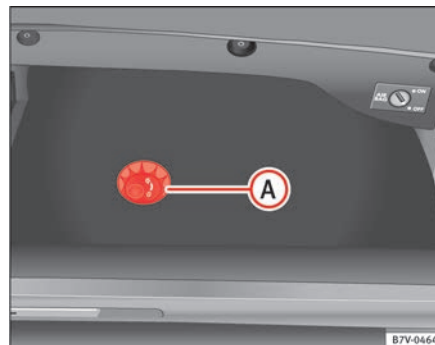

Fig. 108 Glove compartment open.

Opening and closing the glove compartment

Unlock the glove compartment where necessary. The glove compartment is locked when the key slot is vertical. ▶

Pull the lever to *open* ⇒ fig. 107.

Press the cover upwards to *close*.

Vehicle wallet compartment

The glove compartment is designed to store the vehicle wallet.

The vehicle wallet should always be kept in the glove compartment. To store the wallet, insert it sideways into the glove compartment.

Glove compartment cooling

There is an air vent ⇒ fig. 108 (A) on the rear panel so that cooled air from the climate control system (this must be connected) is fed into the glove compartment. Turn the air vent to open and close it.

WARNING

The risk of serious injuries in the event of an accident during a sudden braking manoeuvre or turn is increased if the glove compartment is left open.

- Keep the glove compartment closed while the vehicle is in motion.

CAUTION

For structural reasons, some model versions will have gaps behind the glove compartment into which small objects may fall. This could lead to strange noises and damage to the vehicle. You should therefore not keep very small objects in the glove compartment.

Storage compartments in the rear floor area*

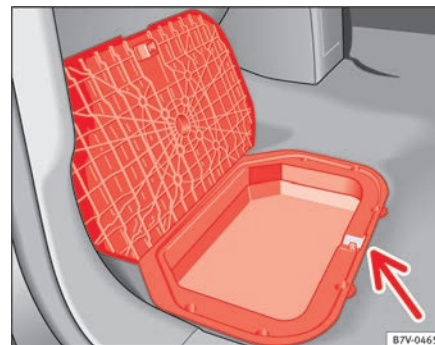

Fig. 109 Storage compartments in the floor area of the second row of seats.

Move the mat to one side (where applicable).

To *open*, pull on the rear centre part of the cover ⇒ fig. 109 (arrow).

To *close*, press the cover down.

WARNING

Make sure children are properly belted in and correctly secured to avoid severe or fatal injuries while the vehicle is in motion.

- If you are using a child seat with a base or foot, always install this base or foot correctly and safely.
- If the vehicle has a storage compartment in the foot well in front of the last row of seats, this compartment cannot be used as designed; on the contrary: It must be filled using the specially designed accessory so that the base or foot is correctly supported by the closed compartment and the child seat is secured properly. If this compartment is not suitably

⚠ WARNING (Continued)

secured when using a child seat with a base or foot then the compartment cover could rupture in an accident and the child will be ejected and suffer serious injury.

- Please read and observe the child seat manufacturer's handling instructions.

⚠ WARNING

If the drawer is open it could obstruct use of the pedals. This could result in serious accident.

- The drawers must remain closed while the vehicle is in motion. Otherwise, the drawer and any objects in it could fall into the driver's footwell and obstruct the pedals.

Drawers*

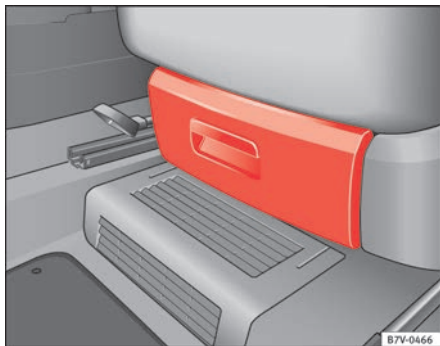

Fig. 110 Drawer under the front seat.

There may be a drawer below the front seats.

Opening and closing the drawer

To *open*, press the button on the drawer handle and pull the drawer out.

To *close*, push the drawer under the seat until it clicks into place.

Folding table*

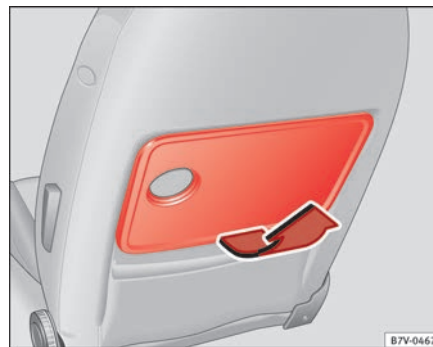

Fig. 111 Folding table on the front seat.

Fold out the table by pulling on it ⇒ **fig. 111** (arrow).

A cup holder is built into the folding table ⇒ page 148.

To *fold it back*, push the folding table down as far as possible ⇒ **fig. 111**. ▶

! WARNING

The folding table must not be folded down while the vehicle is in motion to avoid the risk of injuries.

Portable waste bin*

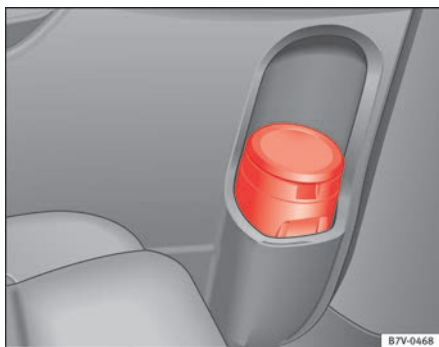

Fig. 112 Portable waste bin on the trim of the left-hand sliding door.

The portable waste bin fits onto the bottle holder on the trim of the left-hand sliding door.

! WARNING

Do not use the portable waste bin as an ashtray to avoid the risk of fire.

Other storage compartments

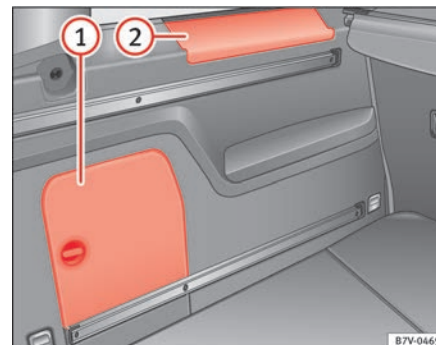

Fig. 113 In the luggage compartment: Side storage compartment.

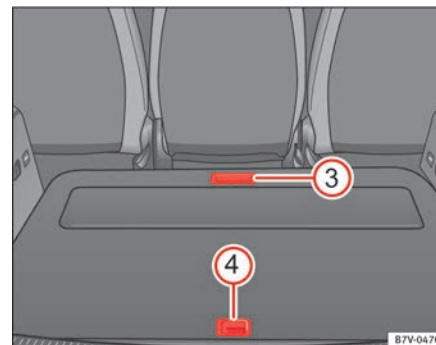

Fig. 114 Other compartments in the luggage compartment floor

Side compartments in the luggage compartment

There are other compartments ⇒ fig. 113 ① and ② in the side of the luggage compartment. To open the compartment ①, turn the catch clockwise. To open the compartment ②, lift the cover. The factory-fitted **CD changer** ▶

can be located in the storage compartment ①. The cover of the compartment ① can be used to safely store the covers of the rear shelf supports.

Compartments in the luggage compartment floor

More storage compartments can be found in the luggage compartment floor.

Function	Necessary operations
Open the front compartment ⇒ fig. 114 ③:	▷ Pull the front of the luggage compartment floor back using the handle.
Open the rear compartment ⇒ fig. 114 ④:	▷ Lift the rear of the luggage compartment floor using the handle.
Keeping the rear compartment open:	▷ Move the hook at the rear right of the luggage compartment and hook the luggage compartment floor onto it ⇒ page 125.
Closing the compartment:	▷ Push back the hook and push the rear of the luggage compartment floor ④ down. ▷ Fold the front part of the luggage compartment floor forwards ③.

Other storage compartments:

- in the centre console, front and rear.
- in the door trims, front and rear.
- **Coat hooks** on the central door pillars and on the rear roof handles.
- **Bag hook** in the luggage compartment ⇒ page 125.

WARNING

Clothing hung on the coat hooks could restrict the driver's view and lead to serious accidents.

- **Hang the clothes from the hooks so that driver's view is not restricted.**
- **The coat hook is suitable for light items of clothing. Never place heavy, hard or sharp objects in the bags.**

CAUTION

Keep the CD changer compartment closed while the vehicle is in motion to reduce vibrations that could damage the changer.

Note

The first aid kit is located in the rear left compartment of the luggage compartment. ■

Cup holders

Introduction

Bottle holders

There is a bottle holder in the open compartments in the driver and front passenger doors and in that of the sliding door.

Additional information and warnings:

- Care and cleaning of the vehicle interior ⇒ page 249 ▶

WARNING

Improper use of the cup holders can cause injury.

- Never place hot drinks in the drink holders. During sudden braking or driving manoeuvres, the hot drink could be spilled and lead to scalding.
- Ensure that bottles and other object is dropped in the driver footwell, as it could get under the pedals and obstruct their working.
- Never place heavy containers, food or other heavy objects in the cup holder. In the event of an accident, these heavy objects could be thrown around the passenger compartment and cause serious injuries.

WARNING

Closed bottles inside the vehicle could explode or crack due to the heat or the cold.

- Never leave a closed bottle in the vehicle if the inside temperature is too high or too low.

CAUTION

Do not leave open cans in the cup holders when the vehicle is in motion. They could spill during braking, for example, and cause damage to the vehicle and the electrical system.

Note

The cup holders can be removed for cleaning.

Cup holders in front centre console

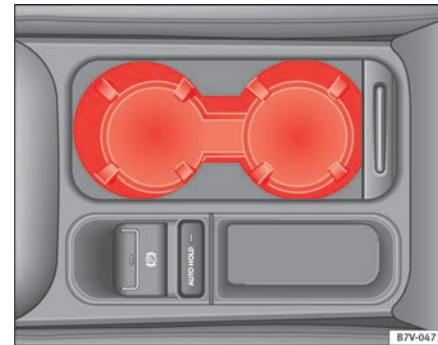

Fig. 115 Front centre console: cup holder.

- To *open*, move the cover backwards ⇒ fig. 115.
- To *close*, move the cover forwards.

Cup holders, rear*

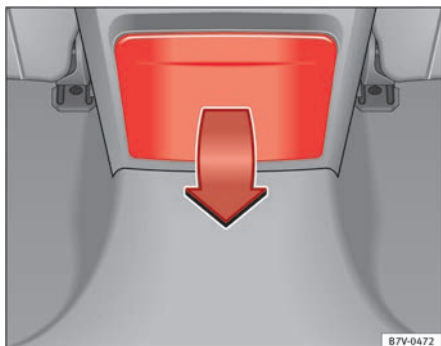

Fig. 116 Centre console, rear section: folding out the cup holder.

Opening and closing the cup holder in the rear centre console

- To *open*, move the cup holder downwards in the direction of the arrow ⇒ fig. 116.
- To *close*, lift the cup holder.

The third row of seats has a cup holder in the side trim compartment on the rear left.

Ashtray and cigarette lighter*

Introduction

Additional information and warnings:

- Sockets ⇒ page 151.
- Accessories, parts replacement, repairs and modifications ⇒ page 257.

WARNING

Undue use of the ashtray and cigarette lighter may cause a fire or burns and other serious injuries.

- Never put paper or other flammable objects in the ashtray.

Ashtray

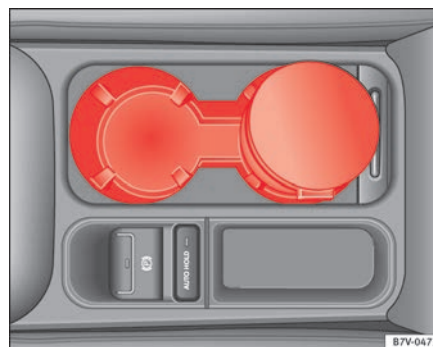

Fig. 117 Front centre console: ashtray closed.

There are ashtrays located on the front of the centre console ⇒ fig. 117 and on the rear lining of the back door.

Opening and closing the ashtray

- To *open*, lift the ashtray cover.
- To *close*, push the ashtray cover down.

Emptying the ashtray

- Remove the ashtray from the cup holder or lining of the door by pulling it upwards.
- After emptying the ashtray, insert it from above into the cup holder or door lining.

Cigarette lighter

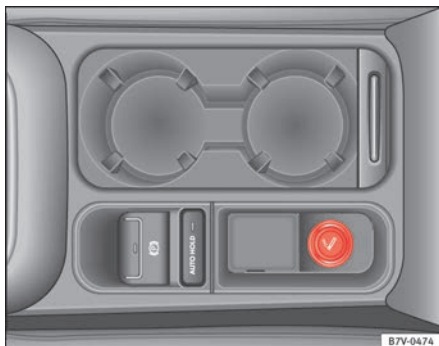

Fig. 118 Front centre console: lighter.

Depending on the vehicle equipment, there may be a lighter to the front of the centre console ⇒ fig. 118 or in the compartment to the front of the centre console.

- Push the button on the cigarette lighter inwards with the ignition on ⇒ fig. 118.
- Wait for the lighter to pop out slightly.
- Pull out the cigarette lighter and light the cigarette on the glowing coil ⇒ ⚠.
- Replace the cigarette lighter in its insert.



WARNING

Undue use of the cigarette lighter may cause a fire or burns and other serious injuries.

- The cigarette lighter must only be used to light cigarettes or similar.
- Never leave children unsupervised in the vehicle. The cigarette lighter can be used when the ignition is switched on.



Note

The cigarette lighter can also be used with the 12 Volt socket ⇒ page 151.

Electrical sockets

Introduction

Electrical equipment can be connected to the sockets in the vehicle.

All connected appliances should be in perfect working order without any faults.

Additional information and warnings:

- Cigarette lighter ⇒ page 150
- Accessories, parts replacement, repairs and modifications ⇒ page 257 ▶

**WARNING**

Improper use of the sockets or electrical devices could lead to a fire and cause serious injuries.

- **Never leave children unsupervised in the vehicle. The sockets and equipment connected to them can be used when the ignition is switched on.**
- **Should a connected electrical device overheat, switch it off and unplug it immediately.**

**CAUTION**

- To avoid damage to the vehicle's electrical system, never connect equipment that generates electrical current, such as solar panels or battery chargers, to the 12 Volt sockets in order to charge the vehicle's battery.
- Only use accessories with approved electromagnetic compatibility according to current regulations.
- To avoid damage due to voltage variations, switch off all appliances connected to the 12 V sockets before switching the ignition on or off and before starting the engine.
- Never connect an appliance to the 12 Volt socket that consumes more than the power indicated in watts. Exceeding the maximum power absorption could damage the vehicle's electrical system.

**For the sake of the environment**

Do not leave the engine running when the vehicle is at a standstill.

**Note**

- Using electrical appliances with the engine stopped and the ignition switched on will drain the battery.
- Unshielded equipment can cause interference on the radio equipment and the vehicle's electrical system.
- Interference can occur on the radio's AM waveband if electrical appliances are used near the rear window aerial. ■

Vehicle sockets

Depending on your vehicle's version, you may have a 12-volt socket and/or a 230 volt socket.



Fig. 119 Centre console, rear section: 12 volt socket.



Fig. 120 Rear centre console: 230 Volt Euro socket.

Maximum power consumption

Socket	Maximum power consumption
12 Volts	120 Watts
230 Volts	150 Watts (300 Watt peak)

The maximum capacity of each socket must not be exceeded. The power consumption is indicated on the rating plate of each appliance.

Where two or more appliances are connected at the same time, the total rating of all the connected devices must never exceed 190 Watts ⇒ ⚠.

12 volt socket

The 12 Volt socket will only work with the ignition on.

Using electrical appliances with the engine stopped and the ignition switched on will drain the battery. Therefore, electrical consumers connected to the socket must only be used when the engine is running.

To prevent voltage variations from causing damage, switch off the electrical consumer connected to the 12 Volt socket before switching the ignition on or off and before starting the engine.

12 Volt sockets can be found in the following locations in the vehicle:

- Compartment in the centre of the centre console.
- Compartment in the front centre console.
- Storage compartment in the front central armrest.
- Rear centre console ⇒ [fig. 119](#).
- At the rear right of the luggage compartment.

230 Volt Euro socket*

The socket only works when the engine is running ⇒ ⚠.

Connecting an electrical appliance: Plug the appliance into the socket as far as possible to unlock the built-in child safety device. The current only flows when the child safety device is unlocked. ▶

LED on the socket ⇒ fig. 120

Steady green light:	The child safety device is unlocked. The socket can now be used.
Flashing red light:	There is some kind of fault (e.g. disconnection due to excess current or temperature).

Heat protection

The 230 Volt Euro power connector converter switches off automatically when a certain temperature is exceeded. This disconnect prevents overheating in the event of an increase in power consumption of the connected appliance and where the atmospheric temperature is too high. The inverter will switch on again automatically after it has cooled down. Appliances that are switched on and connected to the socket will start up again. Therefore, switch off all electrical appliances connected to the socket when the current converter switches off due to overheating.

WARNING
High voltage in the electrical installation!

- **Liquids must not be spilled over the socket.**
- **Do not plug adapters or extension cords into the 230 Volt Euro power connector. Otherwise, the built-in child safety device will switch off and the connector will become live.**
- **Do not plug current conductors such as a knitting needle into the 230 Volt Euro power connector.**

CAUTION

- Always follow the operating instructions for the appliances to be connected!
- Never exceed the maximum power rating as this could damage the vehicle's general electrical system.

- **12 volt socket:**

- Only use accessories with approved electromagnetic compatibility according to current regulations.
- Never power the socket.

- **230 Volt Euro socket:**

- Do not hang appliances or plugs that are too heavy (e.g. a transformer) from the socket.
- Do not connect lamps which contain a neon tube.
- Only plug appliances with a voltage that matches the socket voltage into the socket.
- In the event of consumers with a high start-up current, surge protection prevents them from switching on. In this case, unplug the consumer and try plugging it back in after around 10 seconds.

**Note**

- Some appliances may not work properly in the 230 Volt Euro power connector due to a lack of power (Watts).
- The 230 Watt Euro power connector can be modified for 115 Watt appliances and vice versa. Consult a specialist shop for advice on accessories to adapt the connector. SEAT recommends visiting a Technical Service. ■

Air conditioning

Climate Control

Introduction

Viewing Climatronic information

The factory-fitted radio or navigation system screen briefly displays information relating to Climatronic.

The units of temperature measurement is displayed on the factory-installed radio or navigation system and, depending on the vehicle equipment, can be set using the **Configuration** menu on the instrument panel.

Additional information and warnings:

- SEAT information system ⇒ page 62
- Windscreen wash system ⇒ page 105
- Auxiliary heating ⇒ page 163
- Caring for and cleaning the vehicle exterior ⇒ page 242

WARNING

Reduced visibility through the windows increases the risk of serious accidents.

- **Ensure that all windows are free of ice and snow and that they are not fogged up preventing a clear view of everything outside.**
- **The maximum heat output required to defrost windows quickly is only available when the engine has reached its normal running temperature. Only drive when you have good visibility.**

WARNING (Continued)

- **Always ensure that you use the climate control and heated rear window to maintain good visibility.**
- **Never leave the air recirculation on for a long period of time. If the cooling mode is switched off and air recirculation mode switched on, the windows can mist over very quickly, considerably limiting visibility.**
- **Switch air recirculation mode off when it is not required.**

WARNING

Stuffy or used air will increase fatigue and reduce driver concentration possibly resulting in a serious accident.

- **Never leave the fresh air fan turned off or use the air recirculation for long periods of time; the air inside the passenger compartment will not be refreshed.**

CAUTION

- Switch the climate control system off if you think it may be broken. This will avoid additional damage. Have the air conditioner checked by a specialised workshop.
- Repairs to the air conditioner require specialist knowledge and special tools. SEAT recommends visiting a Technical Service.
- Do not smoke when air recirculation is switched on in vehicles with a climate control system. The smoke taken in could lie on the cooling system vapouriser and on the activated charcoal cartridge of the dust and pollen filter, leading to a permanently unpleasant smell. ▶

**Note**

- When the cooling system is turned off, air coming from the outside will not be dried. To avoid fogging up the windows, SEAT recommends leaving the cooler (compressor) on. To do this, press the  button. The button indicator should light up.
- If the humidity and temperature outside the vehicle are high, **condensation** can drip off the evaporator in the cooling system and form a pool underneath the vehicle, this is completely normal and there is no need to suspect a leak.
- Keep the air intake slots in front of the windscreen free of snow, ice and leaves to ensure heating and cooling are not impaired, and to prevent the windows from misting over. ■

Controls



Fig. 121 Detailed view of the centre console: Climatic controls















Fig. 122 Detailed view of the centre console: Climatronic controls.



To switch a function on or off, press the appropriate button. The corresponding button will light up when a function is switched on. Press the button again to switch off the function.

The LED on each control lights up to indicate that the respective function of a control has been switched on. ►

Some Climatronic controls may also be on the climate control system control panel located in the rear centre console. These controls are used to make the appropriate settings for the rear seats.

Control button	Additional information. Climatic ⇒ fig. 121; Climatronic ⇒ fig. 122.
① Temperature 	Climatic: rotate the control to adjust the temperature accordingly. Climatronic: the settings for the left hand side, the right-hand side and the rear seats are made separately. Rotate the control to adjust the temperature accordingly. The temperature is indicated on the outside ring.
② Fan 	Climatic: setting 0, fan and Climatic switched off; setting 4, fan set to maximum. Climatronic: the Fan speed is automatically adjusted depending on the vehicle speed to avoid annoying noises. The fan can also be adjusted manually.
③ Air distribution 	Climatic: rotate the continuous control to direct the airflow to the desired area. Climatronic: manually adjustable using the controls.
	Climatic: defrost function. The airflow is directed at the windscreen. In this position, air recirculation is automatically switched off or is not switched on.
	Climatronic: defrost function. The air drawn in from outside the vehicle is directed at the windscreen and air recirculation is automatically switched off. To defrost the windscreen more quickly, the air is dehumidified at temperatures over approximately +1.5 °C (+35 °F) and the fan runs at maximum output.
	The air is directed at the chest of driver and passengers by the dashboard air vents.
	– Air distribution towards the footwell.
	Air distribution towards the windscreen and the footwell.
AC	Climatic, Climatronic: Press the button to turn off/on cooling.

Control button	Additional information. Climatic ⇒ fig. 121; Climatronic ⇒ fig. 122.
	Heated rear window: this only works when the engine is running and switches off automatically after a maximum of 10 minutes.
	Air recirculation mode ⇒ page 161.
	Climatronic: Automatic air recirculation ⇒ page 161.
	Windscreen heating: only works when the engine is running and switches off automatically after a few minutes.
	Instant auxiliary heating on/off button ⇒ page 163.
Switching off OFF	Climatic: turn the fan switch to setting 0. Climatronic: press the OFF button or set the fan manually to 0. When the system switches off, the OFF button will light up.
REAR	Climatronic: press the REAR button to adjust the climate control for the rear seats from the front. The REAR button will light up when the function is switched on. The settings for the rear seats will be displayed. Press the button again to switch the function off or do not touch any other button for around 10 seconds.
REST	Climatronic: press the button REST to use residual heat. When the engine is still warm but the ignition switched off, the heat given off by the engine can be used to keep the passenger compartment warm. The REST button will light up when the function is switched on. The function will switch off after around 30 minutes and if the battery level is low. ▶

Control button	Additional information. Climatic ⇒ fig. 121; Climatronic ⇒ fig. 122.
	Climatronic: transferring the driver's seat temperature settings to the other seats. If the  button is not lit up, the set temperature in the driver's seat will also apply to the other seats. Press the button or the temperature control for the front passenger's seat or the rear seats to set them to a different temperature. The button lights with an indicator. Vehicles with auxiliary heating: observe the description of the  button.
AUTO	Automatic temperature, fan, and air distribution control.

WARNING

Never turn off the air fan for a long time or the air in the passenger compartment will not be refreshed.

- Stuffy or used air will increase fatigue and reduce driver and passenger concentration possibly resulting in a serious accident.

Note

- Not all Climatronic buttons are operational in REAR mode.
- The  button is locked in defrost mode.

Rear operation

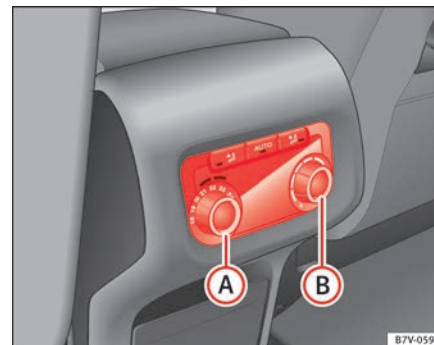



Fig. 123 Details of the rear operation.

Rotary control ⇒ fig. 123	Description
	Temperature selector
	Air flow regulator

Climate control user instructions

The cooling system only works when the engine is running and fan is switched on.

The climate control system operates most effectively with the windows and the sliding panoramic roof closed. However, if the vehicle has heated up after standing in the sun for some time, the air inside can be cooled more quickly by opening the windows briefly.

Keep the air intake slots in front of the windscreen free of snow, ice and leaves to ensure heating and cooling are not impaired, and to prevent the windows from misting over.

Adjustment for safer driving

When the air conditioning is switched on, the temperature and the air humidity in the vehicle interior drop. Hence, when the outside air humidity is high, the windows do not mist over and comfort for the vehicle occupants is improved:



With Climatic

- Disable air recirculation mode ⇒ page 161.
- Set the fan to setting 1 or 2.
- Turn the temperature control to the centre position.
- Open the air outlets in the dash panel ⇒ page 161.
- Turn the air distribution control to the required position.
- Press the  button to turn on cooling. The button will light up.

With Climatronic

- Press the  button.
- Set the temperature to +22 °C (+72 °F).
- Open the air outlets in the dash panel ⇒ page 161.

Switching the Climatronic temperature measuring unit

Press and hold the  and  buttons to switch the temperature display between Celsius and Fahrenheit.

Heat

The maximum heat output required to defrost windows quickly is only available when the engine has reached its normal running temperature.

The air conditioning system does not switch on

If the air conditioning system cannot be switched on, this may be caused by the following:

- The engine is not running.
- The fan is switched off.
- The climate control fuse has blown.
- The outside temperature is lower than approximately +3 °C (+38 °F).
- The climate control system compressor has been temporarily switched off because the engine coolant temperature is too high.
- Another fault in the vehicle. Have the air conditioner checked by a specialised workshop.

Things to note

If the humidity and temperature outside the vehicle are high, **condensation** can drip off the evaporator in the cooling system and form a pool underneath the vehicle. This is normal and does not indicate a leak!

Dust and pollen filter

The dust and pollen filter with its activated charcoal cartridge serves as a barrier against impurities in the ambient air.

For the climate control system to work with maximum efficiency, the dust and pollen filter must be replaced at the intervals specified in the Maintenance Programme.

If the filter loses efficiency prematurely due to use in areas with very high levels of air pollution, the filter must be changed more frequently than stated in the Service Schedule.

Note

- The climate control system must left running for a few minutes to reach the set temperature in the vehicle interior.
- After starting it, any residual humidity in the climate control system could mist over the windscreen.
- The air from the vents flows through the passenger compartment and out through the outlets below the rear window. Do not cover these outlets with items of clothing or other objects. ■

Air vents

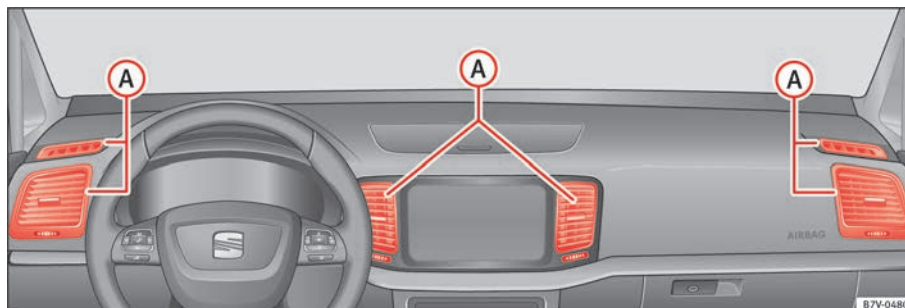

Fig. 124 Air vents in the instrument panel.

Air vents

Never close the air vents => fig. 124 (A) completely to ensure heating, cooling and ventilation inside the vehicle.

- Turn the thumbwheel in the required direction to open and close the air vents.
- Change the air direction using the ventilation grille lever.

There are additional vents in the footwell areas and in the rear of the passenger compartment.





CAUTION

Never place food, medicines or other heat-sensitive objects close to the air vents. Food, medicines and other heat-sensitive objects may be damaged or made unsuitable for use by the air coming from the air vents. ■

Air recirculation mode



Important

Air recirculation works in two ways:

	Manual air recirculation mode.
	Automatic air recirculation mode.

Air recirculation mode  prevents the ambient air from entering the vehicle interior.

When the outside temperature is very high or very low, selecting manual air recirculation mode for a short period refreshes or heats the vehicle interior more quickly.

For safety reasons, air recirculation mode is switched off when the  button is pressed or the air distributor turned to  => .

Switching air recirculation mode on and off manually

Switching on: press the corresponding button until the light under the symbol  comes on.

Switching off: press the button until no indicator remains lit.

Automatic air recirculation mode

Fresh air enters the vehicle interior in position . If the system detects a high concentration of hazardous substances in the ambient air, air recirculation mode is switched on automatically. When the level of impurities drops to within a normal range, recirculation mode is switched off.

The system is unable to detect unpleasant smells.

Air recirculation mode is **not** automatically switched on in the following cases of outside temperatures and conditions:





- The cooling system is switched on (the  button is lit up) and the outside temperature is below +3 °C (+38 °F).
- The cooling system and the windscreen wipers are switched off and the outside temperature is below +10 °C (+50 °F).
- The cooling system is switched on, the outside temperature is below +15 °C (+59 °F) and the windscreen wipers are switched on.

Switching the automatic air recirculation mode on and off

Switching on: press the  button until the light under the symbol  comes on.

Switching off: press the  button until no button remains lit.

Switching the automatic air recirculation mode off temporarily

- Press the  button once to temporarily switch to manual air recirculation mode in the event of unpleasant smells from outside. The control light under the symbol  comes on.
- After more than two seconds, press the  button again to restart automatic air recirculation. The control light under the symbol  comes on.

WARNING

Stuffy or used air will increase fatigue and reduce driver concentration possibly resulting in a serious accident.

- **Never use recirculation mode for long periods as it does not refresh the air inside the vehicle.**
- **If the cooling mode is switched off and air recirculation mode switched on, the windows can mist over very quickly, considerably limiting visibility.**
- **Switch air recirculation mode off when it is not required.**

CAUTION

Do not smoke when air recirculation is switched on in vehicles with a climate control system. The smoke taken in could lie on the cooling system vapouriser and on the activated charcoal cartridge of the dust and pollen filter, leading to a permanently unpleasant smell.

Note

Air recirculation mode switches on to prevent exhaust gas from entering the vehicle interior when it is in reverse and while the automatic windscreen wash and wipe is working. ■

Auxiliary heater* (additional heater)

Introduction

The auxiliary heater is powered by fuel from the vehicle's fuel tank and can be used while the vehicle is in motion and at a standstill. Select the mode required (**heat** or **fan**) ⇒ page 165 on the instrument panel.

In winter, the auxiliary heater can be used in **heat** mode before switching on the ignition to remove any ice, mist or snow from the windscreen (thin layers only).

Additional information and warnings:

- SEAT information system ⇒ page 62
- Refuelling ⇒ page 264

WARNING

The auxiliary heater fumes contain carbon dioxide, an odourless and colourless toxic gas. Carbon monoxide can cause people to lose consciousness. It can also cause death.

- Never switch on the auxiliary heater or leave it running in places that are enclosed or unventilated.
- Never program the independent heating system to be activated and operated in closed, unventilated areas.

WARNING

The components of the auxiliary heater exhaust system heat up a great deal. This could cause a fire.



- Always park your vehicle so that no part of the exhaust system can come in contact with flammable materials (such as dried grass).

CAUTION



Never place food, medicines or other heat-sensitive objects close to the air vents. Food, medicines and other heat-sensitive objects may be damaged or made unsuitable for use by the air coming from the air vents. ■

Switching the auxiliary heater on and off

Switching the auxiliary heater on:

	Manually using the instant on/off button.	⇒ page 157
	Manually using the remote control.	⇒ page 164
	Automatically at the programmed and enabled on	⇒ page 165
	time.	

Switching the auxiliary heater off:

	Manually using the instant on/off button for the climate control system.	⇒ page 157
	Manually using the remote control.	⇒ page 164
	Automatically after the programmed time.	⇒ page 165
	Automatically when the light comes on  (fuel reserve).	⇒ page 264
	Automatically when the battery power drops to a very low level.	⇒ page 288

Things to note

After switching the auxiliary heater off, it continues to run for a short period to completely burn any fuel remaining in the auxiliary heater. The exhaust fumes are also extracted from the system. ■

Remote control

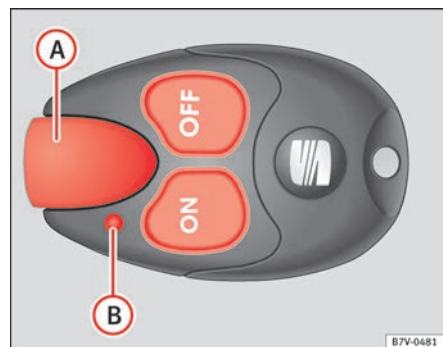

Fig. 125 Auxiliary heater: remote control.

fig. 125	Meaning
	Switch the auxiliary heater on.
	Switch the auxiliary heater off.
	Aerial.
	Light.

The auxiliary heater may accidentally switch on if a button is pressed on the remote control by mistake. This may also occur outside the range of the remote control or if the light flashes.

Remote control light

The remote control light provides users with different information at the push of a button:

Battery light fig. 125	Meaning
Lights up green for around two seconds.	The auxiliary heater has been switched on using the button.
Lights up red for around two seconds.	The auxiliary heater has been switched off using the button.
Slowly flashes green for around two seconds.	No on ^{a)} signal has been received.
Quickly flashes green for around two seconds.	The auxiliary heater is locked. Possible causes: the fuel tank is almost empty, the battery charge is very low or there is a fault.
Flashes red for around two seconds.	No off ^{a)} signal has been received.
Lights up orange for around two seconds, then green or red.	The remote control battery is almost flat. However, the on or off signal has been received, respectively.
Lights up orange for around two seconds, then flashes green or red.	The remote control battery is almost flat. The on or off signal has not been received, respectively.
Flashes orange for around five seconds.	The remote control battery is flat. The on or off signal has not been received, respectively.

^{a)} Within its range, the remote control might not receive the signal sent by the vehicle receiver. In this case, the remote control will send an error message despite the auxiliary heater being on or off. Come closer to the vehicle and press the corresponding button on the remote control once again.

Replacing the remote control battery

When the light on the remote control does not come on when the button is pressed, the remote control battery should soon be replaced.

The battery is located beneath a cover on the back of the remote control. Turn the slot to the left using a flat, blunt object (e.g. a coin). When changing the battery, use another battery of the same model and observe the polarity when fitting it ⇒

Range

The receiver is in the interior of the vehicle. The remote control, when fitted with new batteries, has a range of several hundred metres. Obstacles between the remote control and the vehicle, bad weather conditions and discharged batteries can considerably reduce the range of the remote control.

An optimum range is obtained by keeping the remote control vertical, with the aerial  pointing upwards. When doing so, do not cover the aerial with your fingers or with the palm of your hand.

There must be a *minimum* distance of two metres between the remote control and the vehicle.



CAUTION

- The radiofrequency remote control contains electronic components. Therefore, avoid getting the remote control wet and from being knocked and protect it from direct sunlight.
- Use of inappropriate batteries may damage the remote control. For this reason, always replace the dead battery with another of the same voltage, size and specifications.



For the sake of the environment



- Please dispose of old batteries so that they do not harm the environment.
- The remote control battery may contain perchlorate. Observe the legal requirements for their disposal.



Programming the auxiliary heater

The heater or ventilation inside the vehicle can be programmed for a certain period.

Before programming, check that the day is correctly set in the **Auxiliary heater - day of the week** menu ⇒ .

Enabling the Auxiliary heater menu on the instrument panel

- From the main menu, select the **Auxiliary heater** submenu and press the  button on the windscreen wiper lever.
- **ALTERNATIVELY:** press the  or  arrow buttons on the multi-function steering wheel until the **Auxiliary heater** menu is displayed.

Menu options	Description
Switching on Switching off	The auxiliary heater can be set to come on automatically if required. To do so, select a timer: – The timer is displayed marked with a  . – Only one timer can be selected. If a timer has been selected, Prog. ON will be displayed on the screen. If <i>no</i> timer has been selected, the instrument panel screen will display Prog. OFF . – To modify the programmed timer, select another timer or select the Off option.
Timer 1 Timer 2 Timer 3	Three different timers (hh.mm) can later be selected using the On option. If the auxiliary heater is to be switched on for just a certain day of the week, select the day of the week and the time for the auxiliary heater to come on.
Duration	The operating time may vary between 10 and 60 minutes and can be set to 5-minute intervals.
Operating mode	Set to heat or ventilate the vehicle interior when the auxiliary heater is switched on.
Day	Set the current day of the week.
Factory settings	The predefined factory values for the functions of this menu are restored.
Back	This returns to the main menu 

Checking programming

If the **timer** has been switched on after switching the ignition off, the instant on button  will remain lit for around ten seconds.



WARNING

Never program the independent heating system to be activated and operated in closed, unventilated areas. The auxiliary heater fumes contain carbon dioxide, an odourless and colourless toxic gas. Carbon monoxide can cause people to lose consciousness. It can also cause death.

Operating instructions

The auxiliary heater exhaust system located below the vehicle must be kept clear of snow, mud and other objects. The exhaust fumes must not be obstructed in any way. The exhaust fumes generated by the auxiliary heater are removed via an exhaust pipe fitted underneath the vehicle.

On heating the vehicle interior, depending on the outside temperature the warm air is first directed at the windscreen and then to the rest of the passenger compartment through the air vents. If the air vents are turned towards the windows, for example, the form of air distribution may be affected.

Depending on the outside temperature, the temperature at which the auxiliary heater warms the vehicle interior may be somewhat higher if the heating or climate control temperature control is set to maximum before switching the heating on.

Depending on the engine, vehicles with auxiliary heater may be fitted with a second battery in the luggage compartment that is responsible for powering the auxiliary heater.

Cases in which the auxiliary heater will not switch on

- The auxiliary heater requires about as much power as the dipped headlights. If the battery charge is low, the auxiliary heater will switch off automatically or will not even switch on. This avoids problems when starting the engine.
- The heater will switch just once each time. The timer will also have to be switched back on every time it is required.



Note

- Noise will be heard while the auxiliary heater is running.
- When the air humidity is high and the outside temperature low, the heating system may evaporate condensation from the auxiliary heater. In this case, steam may be released from underneath the vehicle. This is completely normal and there is no need to suspect a fault!
- If the auxiliary heater runs several times over a prolonged period, the vehicle battery may run flat. To re-charge the battery, drive the vehicle for a long distance. In general: drive for as much time as the auxiliary heating was working.

Driving

Steering

Introduction

The power steering is not hydraulic but electromechanical. The advantage of this steering system is that it disposes of hydraulic tubes, hydraulic oil, the pump, filter and other components. The electromechanical system saves fuel. While a hydraulic system requires oil pressure to be maintained, electromechanical steering only requires energy when the steering wheel is turned.

With the power steering system, the assisted steering function automatically adjusts according to the vehicle speed, the steering torque and the wheel turning angle. The power steering only works when the engine is running.

Additional information and warnings:

- Start and stop the engine ⇒ page 170
- Vehicle battery ⇒ page 288
- Tow-starting and towing away ⇒ page 340







WARNING

If the power steering is not working then the steering wheel is much more difficult to turn and the vehicle more difficult to control.

- The power steering only works when the engine is running.
- Never allow the vehicle to move when the engine is switched off.
- Never remove the key from the ignition if the vehicle is in motion. The steering may lock and it will not be possible to turn the steering wheel.

Control and warning lamps

lights up	Possible cause	Solution
 (red)	Power steering faulty.	The steering system should be checked by a Technical Service as soon as possible.
 (yellow)	Power steering operation reduced.	The steering system should be checked by a qualified workshop as soon as possible. If, after restarting the engine and driving for a short distance, the yellow warning light no longer comes on, it will not be necessary to take the vehicle to a specialised workshop.
	The vehicle battery was disconnected and has been reconnected.	Drive for a short distance at 15 – 20 km/h. ▶

flashes	Possible cause	Solution
 (red)	Fault in the steering column electronic lock.	 Do not drive on! Seek professional advice.
 (yellow)	Steering column deviation.	Gently turn the steering wheel to and fro.
	Steering wheel not unlocked or locked.	Remove the key from the ignition and then switch the ignition back on. Check the messages displayed on the instrument panel at the same time. Do not drive on, if the steering column remains locked after the ignition has been switched on. You should obtain professional assistance.

Several warning and control lamps should light up for a few seconds when the ignition is switched. This signals that the lamp is working properly. They will switch off after a few seconds.

 **WARNING**

If the warning lamps and messages are ignored, the vehicle may stall in traffic, or may cause accidents and severe injuries.

- **Never ignore the warning lamps or text messages.**
- **Stop the vehicle safely as soon as possible.**

 **CAUTION**

Failure to heed the warning lamps and text messages when they appear may result in faults in the vehicle. ■

Information on the steering

Steering column electronic lock

If the driver's door is opened before the ignition is switched off, the steering column electronic lock is activated via the ignition key or the sensor built into the door handle.

Mechanical steering lock

To prevent theft, we recommend you lock the steering before leaving the vehicle.

Please engage steering lock	Unlocking the steering
Parking the vehicle ⇒ page 183.	Turn the steering wheel slightly to release the steering lock.
Remove the key from the ignition.	Insert the key in the ignition lock.
Turn the steering wheel slightly until you hear the steering lock.	Hold the steering wheel in this position and switch on the ignition.

Electromechanical power steering

With the power steering system, the assisted steering function automatically adjusts according to the vehicle speed, the steering torque and the wheel turning angle. The power steering only works when the engine is running.

You should remember that you will need considerably more power than normal to steer the vehicle if the power steering is not working correctly or not at all.

Counter steering assistance system

The counter steering assistance system helps the driver in critical situations. Additional steering power helps the driver when counter steering. ▶

! WARNING

The counter steering assistance system combined with ESC (ESP) helps the driver to steer the vehicle in critical driving conditions. At all times, it is the driver who steers the vehicle. The counter steering system does not steer the vehicle.

Adjusting the steering wheel position

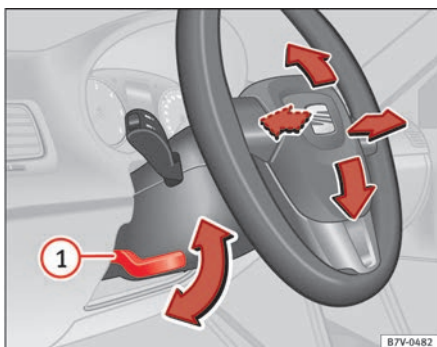

Fig. 126 Mechanical steering wheel adjustment.

Adjust the steering wheel before your trip and only when the vehicle is stationary.

- Push the lever ⇒ fig. 126 ① downwards.
- Adjust the steering wheel so that you can hold onto the steering wheel with both hands on the outside of the ring at the 9 o'clock and 3 o'clock positions and your arms slightly bent.
- Push the lever firmly upwards until it is flush to the steering column ⇒ ⚠.

! WARNING

Incorrect use of the steering wheel adjustment function and an incorrect adjustment of the steering wheel can result in severe or fatal injury.

- After adjusting the steering column, push the lever ① firmly upwards to ensure the steering wheel does not accidentally change position while driving.
- Never adjust the steering wheel while the vehicle is in motion. If you need to adjust the steering wheel while the vehicle is in motion, stop safely and make the proper adjustment.
- The adjusted steering wheel should be facing your chest and not your face so as not to hinder the driver's frontal airbag protection in the event of an accident.
- When driving, always hold the steering wheel with both hands on the outside of the ring at the 9 o'clock and 3 o'clock positions to reduce injuries when the driver's frontal airbag deploys.
- Never hold the steering wheel at the 12 o'clock position or in any other manner (e.g. in the centre of the steering wheel). In such cases, if the driver's airbag deploys, you may sustain injuries to your arms, hands and head.

Stopping and starting the engine

Introduction

Immobiliser display

When an invalid key is used or in the event of a system fault, **SAFE** or **Immobiliser on** is displayed on the instrument panel. The engine cannot be started.

Pushing or towing

For technical reasons, the vehicle must **not** be push- or tow-started. Jump starting is preferable.

Additional information and warnings:

- Vehicle key set ⇒ page 71
- Changing gear ⇒ page 174
- Braking, stopping and parking ⇒ page 183
- Steering ⇒ page 167
- Start assist systems ⇒ page 194
- Refuelling ⇒ page 264
- Fuel ⇒ page 267
- Emergency locking and unlocking ⇒ page 314
- Jump starting ⇒ page 337
- Tow-starting and towing away ⇒ page 340

WARNING

Turning off the engine while driving will make stopping the vehicle difficult; this could even result in the loss of control causing an accident with serious consequences.

- The assisted braking and steering systems, the airbag system, safety belts and certain safety equipment are only active while the engine is running.
- The engine should only be switched off when the vehicle is at a standstill.

WARNING

While the engine is running or starting it could help reduce the risk of serious injury.

- **Never start or leave the engine running in poorly ventilated or closed spaces.** Exhaust gas contains carbon monoxide, a toxic, colourless and odourless gas. Carbon monoxide can cause people to lose consciousness. It can also cause death.
- **Never leave the vehicle unattended if the engine is running.** The vehicle could move off suddenly or something unexpected could happen resulting in damage and serious injury.
- **Never use start boosters.** Cold start sprays could explode or increase the engine speed unexpectedly.

! **WARNING**

The components of the exhaust system reach very high temperatures. This could cause a fire and considerable damage.

- Always park your vehicle so that no part of the exhaust system can come in contact with flammable materials (such as wood, leaves, spilled fuel, dried grass, etc).
- Do not apply additional underseal or anti-corrosion coatings to the exhaust pipes, catalytic converter, heat shields or the diesel particulate filter.

Ignition lock



Fig. 127 Vehicle key positions

Car keys ⇒ fig. 127

No key in the ignition lock: The steering lock may be activated.

- 0 Ignition off, all electrical components disconnected. Key can be removed from the vehicle.

Car keys ⇒ fig. 127

- 1 Ignition is switched on. Pre-heating of diesel engine. The steering lock can be unlocked.
- 2 Switch on the engine. Release the key when the engine has started. When it is released, the key returns to position 1.

Key not authorised for the vehicle

If a key which is not authorised for this vehicle is inserted in the ignition lock, it can be removed as follows:

- Automatic gearbox: the key cannot be removed from the ignition lock. Press and release the selector lever locking button. Key can be removed from the vehicle.
- Manual gearbox: Remove the key from the ignition.



WARNING

Unsuitable or careless use of the vehicle key could result in serious injury.

- Always take all the keys with you whenever you leave the vehicle. The engine could accidentally be started and electrical equipment such as the windows could accidentally be operated resulting in serious injury.
- Never leave children or disabled people alone in the car. They could be trapped in the car in an emergency and will not be able to get themselves to safety. For example, depending on the time of the year, temperatures inside a locked and closed vehicle can be extremely high or extremely low resulting in serious injuries and illness or even death, particularly for young children.
- Never remove the key from the ignition if the vehicle is in motion. The steering may lock and it will not be possible to turn the steering wheel.



Note

- If the key is left in the ignition lock with the engine off for long periods, the vehicle battery will run flat.
- For **automatic gearbox vehicles** the key can only be removed from the ignition lock if the gear selector lever is in position **P**. In this case, press and release the selector lever locking button. ■

Starting the engine

Complete operations only in the sequence given:

Step	
1.	Press the brake pedal and keep pressed until step 5 has been completed.
1 a.	In vehicles with a manual gearbox: Press the clutch pedal all the way and keep pressed until the engine starts.
2.	Put the gearstick in neutral or the selector lever in position P or N .
3.	Only in vehicles with diesel engine: To preheat, turn the key in the ignition lock to position ⇒ fig. 127 ①. A warning lamp lights up in the control panel ☹.
4.	Turn the key in the ignition lock to position ⇒ fig. 127 ②; do not press the accelerator.
5.	When the engine has started, release the key in the ignition lock.
6.	If the engine does not start, stop the process and try again after one minute.
7.	Disconnect the electronic parking brake when you wish to start driving ⇒ page 183.



WARNING

Never leave the vehicle unattended if the engine is running. The vehicle could move off suddenly, especially if it is in gear, resulting in an accident and serious injury. ▶

 **WARNING**

Cold start sprays could explode or cause a sudden increase in the engine speed.

- **Never use start boosters.**

 **CAUTION**

- An attempt to start the engine while driving or starting the engine immediately after turning it off can cause damage to the engine or starter motor.
- When the engine is cold, avoid high revs and heavy acceleration and do not make the engine work hard.
- Do not push or tow start the engine. Sunburnt fuel could damage the catalytic converter.

For the sake of the environment



Do not warm the engine at idle speed; start driving immediately if the visibility is OK. This helps the engine reach operating temperature faster and reduces emissions.

Note

- For example, if the key battery is very worn or flat, the engine cannot be started with the starter button. In this case, remove the ignition button from the lock and insert the key.
- Electrical components with a high power consumption are switched off temporarily when the engine starts.
- When the engine is started cold, there may be strong vibrations for a few moments for technical reasons. This is quite normal, and no cause for concern.
- At temperatures below +5 °C (+41 °F), smoke may be given off below the vehicle when the additional heater is connected. ■

Stopping the engine

Complete operations only in the sequence given:

Step	
1.	Stopping the vehicle completely ⇒  .
2.	Press the brake pedal and keep pressed until step 4 has been completed.
3.	In automatic gearboxes, put the selector lever in position P .
4.	Connect the electronic parking brake ⇒ page 183.
5.	Turn the key in the ignition lock to position ⇒ fig. 127  .
6.	With a manual gearbox, put the vehicle in first or reverse gear.

WARNING

Never switch off the engine while the vehicle is moving. You may lose control of the vehicle and there is a risk of serious accident.

- **The airbags and belt tensioners do not work when the ignition is switched off.**
- **The brake servo does not work with the engine off. To stop, the brake pedal must be pressed with more force.**
- **As the power steering does not work if the engine is not running, you will need more strength to steer than normally.**
- **If the key is removed from the ignition, the steering may lock and it will not be possible to steer the vehicle.**

CAUTION

If the engine has been driven at high speed for a prolonged period of time, it may overheat when turned off. To avoid engine damage, allow the engine to run for approximately two minutes in neutral before switching it off. ▶

**Note**

- In vehicles with automatic gearbox, the key can only be removed when the selector lever is in position **P**.
- After stopping the engine, the engine compartment fan may continue running for a few minutes, even when the ignition has been switched off or the key removed. The radiator fan is automatically switched off.

Electronic immobiliser

The gear lock prevents the engine from being started with an unauthorised key and the vehicle being moved.

The vehicle key has a built-in chip. It automatically deactivates the immobilizer when the key is inserted into the ignition lock.

For this reason, the vehicle can only be used with a genuine SEAT key with the correct code. Coded keys can be obtained from your Authorised Service Centre ⇒ page 71.

If an unauthorised key is used, the message **SAFE** or **Immobiliser active** is displayed on the instrument panel. The vehicle cannot be started in this case

**Note**

The correct operation of the vehicle is only guaranteed when original SEAT keys are used.

Changing gear

Introduction

When reverse gear is engaged and the ignition is switched on the following takes place:

- Reverse lights light up.
- When reversing, the air conditioner automatically changes to air recirculation mode.
- The rear window heater switches on when the windscreen wiper is activated.
- Also, the parking sensor system, the optical parking sensor and the camera for the reverse assist system are connected.

Additional information and warnings:

- Instruments ⇒ page 57
- Braking, stopping and parking ⇒ page 183
- Parking sensor system ⇒ page 198
- Park Assist system ⇒ page 202
- Reverse assist system (Rear Assist) ⇒ page 207
- Air conditioning ⇒ page 155
- Electronic power control and exhaust gases purification system ⇒ page 228
- Emergency locking and unlocking ⇒ page 314

**WARNING**

Rapid acceleration can cause loss of traction and skidding, especially on slippery ground. This could cause loss of control of the vehicle resulting in an accident and considerable damage.

- **Only use the kickdown or rapid acceleration if visibility, weather, road and traffic conditions so permit.**



 **WARNING**

Do not allow the brakes to “rub” for a prolonged period of time, or brake frequently or for long periods of time. Continuous braking heats up the brakes. This could significantly reduce braking power, increase braking distance or even result in the total failure of the brake system.

 **CAUTION**

- Never make the brakes slip by pressing the pedal gently, if it is not really necessary to brake. This will increase wear.
- Reduce speed, move down a gear or select a shorter range of gears before long steep slopes. This allows you to use the engine braking effect and to reduce the strain on the brake system. Otherwise, the brakes may over-heat and fail. Only use the brakes to reduce speed or to stop.

Warning and control lamps

lights up	Possible cause	Solution
 (red)	Brake pedal not pressed!	Press brake pedal to the floor.
 (green)	Brake pedal not pressed.	To select a range of gears, press the brake pedal. Please also see "Electronic parking brake" ⇒ page 183.
flashes	Possible cause	Solution
 (green)	The selector lever locking button has not engaged. The vehicle does not start to move.	Engage the selector lever lock ⇒ page 178.

Several warning and control lamps should light up for a few seconds when the ignition is switched. This signals that the lamp is working properly. They will switch off after a few seconds.

 **WARNING**

If the warning lamps and messages are ignored, the vehicle may stall in traffic, or may cause accidents and severe injuries.

- Never ignore the warning lamps or text messages.
- Stop the vehicle safely as soon as possible.
- If the vehicle stops and must be stopped for repairs, always park a safe distance from surrounding traffic, turn on the hazard warning lights, stop the engine and take all of the safety measures necessary to warn other road users.

 **CAUTION**

Failure to heed the warning lamps and text messages when they appear may result in faults in the vehicle.

Pedals

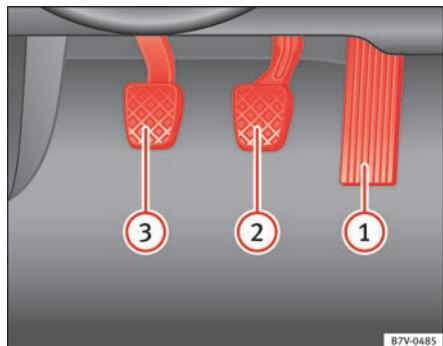

Fig. 128 Pedals in vehicles with a manual gearbox: ① accelerator; ② brake; ③ clutch.

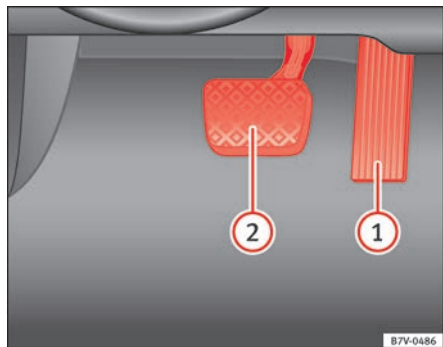

Fig. 129 Pedals in vehicles with an automatic gearbox: ① accelerator; ② brake.

Do not allow floor mats or other objects to obstruct the free passage of the pedals.

Floor mats should leave the pedal area free and unobstructed and be correctly secured in the footwell zone.

In the event of failure of a brake circuit, the brake pedal must be pressed harder than normal to brake the vehicle.

WARNING

Objects falling into the driver's footwell could prevent use of the pedals. This could lead the driver to lose control of the vehicle, increasing the risk of a serious accident.

- Make sure the pedals can be used at all times, with no objects rolling underneath them.
- Always secure the mat in the foot well.
- Never place other mats or rugs on top of the original mat supplied by the factory.
- Ensure that no objects can fall into the driver's footwell while the vehicle is in motion.

CAUTION

The pedals must always have free and unobstructed passage to the floor. For example, in case of a fault in the brake circuit, the brake pedal will need to be pressed further to stop the vehicle. To press the brake pedal down further will require more force than usual. ■

Manual gearbox: Engaging gears

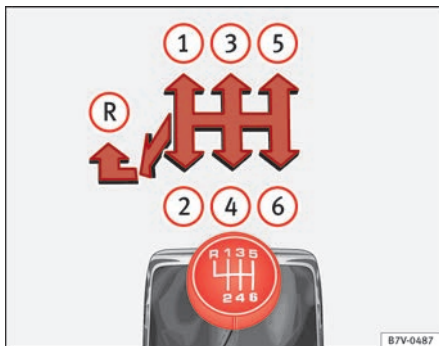

Fig. 130 Gear shift pattern of a 6-speed manual gearbox.

The position of each of the gears is shown on the gear stick ⇒ fig. 130.

- Keep the clutch pedal pushed all the way down.
- Move the gear stick to the required position.

In some countries, it is necessary to press the clutch pedal to the floor to start the engine.

Selecting reverse gear

- With the vehicle at a standstill, press the clutch pedal to the floor and keep pressed.
- Push the gear lever down.
- Move the gear stick to the left and then forwards to reverse gear **R**.



WARNING

When the engine is running, the vehicle will start to move as soon as a gear is engaged and the clutch released. This is also the case with the electronic parking brake on.

- Never engage the reverse gear when a vehicle is moving forward.



CAUTION

To prevent damage and avoid premature wear, please observe the following:

- While driving, do not leave your hand resting on the gear stick. The pressure applied by your hand is transmitted to the gearbox selector forks.
- Always ensure that the vehicle is completely stopped before engaging the reverse gear.
- When changing gear, always make sure the clutch pedal is pushed right to the floor.
- Never hold the vehicle on the clutch on hills. ■

Automatic gearbox*: Selecting gears



Fig. 131 Left-hand drive vehicles: Automatic gearbox selector lever with locking button (arrow).



Fig. 132 Right-hand drive vehicles: Automatic gearbox selector lever with locking button (arrow).

The gear selection lever has a lock. When changing the selector lever from position **P** to a range of gears, press the brake pedal and press the lock on the selector lever, located on the front part of the knob, in the direction of

the arrow ⇒ **fig. 131** or ⇒ **fig. 132**. To move the gear selector lever from the position **N** to **D** or to **R**, first press and hold the brake pedal.

When the ignition is on, the current position of the selector lever is shown on the instrument panel.

Selector lever positions	Denomination	Meaning ⇒ ⚠
P	Parking lock	The drive wheels are locked mechanically. They only engage when the vehicle is <i>at a standstill</i> . To change the position of the selector lever, press the brake pedal and switch on the ignition.
R	Reverse gear	Reverse gear is engaged. Only select reverse gear when the vehicle is <i>at a standstill</i> .
N	Neutral	The gear box is in neutral. No movement is transmitted to the wheels and the engine does not act as a brake.
D	Standard forwards driving position (normal programme)	The gears are changed (up and down) automatically. The gear shifts are determined by the engine load, your individual driving style and the speed of the vehicle.
S	Standard forwards driving position (sports programme)	The shift up to a higher gear is automatically <i>delayed</i> and the shift down is <i>faster</i> with respect to the D range of gears, to take full advantage of the engine power. The gear shifts are determined by the engine load, your individual driving style and the speed of the vehicle.

Selector lever locking

The gear selector lever lock prevents, in **P** or **N**, a gear selection from being inadvertently engaged and the vehicle moving off accidentally. ▶

To release the gear selector lever lock, press and hold the brake pedal with the ignition on. Press simultaneously on the selector lever lock.

The selector lever lock is not engaged if the selector lever is moved quickly through position **N** (e.g. when shifting from **R** to **D**). This makes it possible, for instance, to rock the vehicle backwards and forwards if it is stuck in snow or mud. The selector lever lock engages automatically if the brake pedal is not pressed and the lever is in position **N** for more than about one second at a speed of less than 5 km/h (3 mph).

In vehicles with a DSG® automatic gearbox, on rare occasions the selector lever lock may not engage. In this case, the transmission is locked to prevent the vehicle from moving accidentally. The green control light  flashes and an information text is displayed. Proceed as follows to engage the selector lever lock:

- Press the brake pedal and then release.

WARNING

Placing the selector lever in an incorrect position may cause loss of control of the vehicle and a serious accident.

- Do not press the accelerator when engaging a range of gears.
- With the engine running and a range of gears selected, the vehicle will move off when the brake pedal is released.
- Never select reverse gear or the parking lock while driving.

WARNING

Unintentional movements of the vehicle could cause serious injury.

- As a driver, you should never leave your vehicle if the engine is running and a gear is engaged. If you have to leave your vehicle while the engine is running, you must apply the electronic parking brake and engage parking lock **P**.

WARNING (Continued)

- While the engine is running and with the **D**, **S** or **R** range of gears selected, keep the brake pressed to keep the vehicle at a standstill. Transmission is not totally interrupted either when the vehicle is idling or when the vehicle continues moving forwards.
- Never engage the **R** or **P** gear ranges when the vehicle is moving.
- Never leave the vehicle with the gear selector in **N**. The vehicle may move downhill regardless of whether the engine is switched on or not.

CAUTION

If, when the vehicle is at a standstill, the electronic parking brake is **not** applied and the brake pedal is released while in position **P**, the vehicle may move a few centimetres forwards or backwards.

Note

If, while driving, the selector lever is accidentally placed in position **N**, lift your foot off the accelerator. Wait until the engine is running at idle speed before selecting a new gear ratio. ■

Changing gears with Tiptronic*

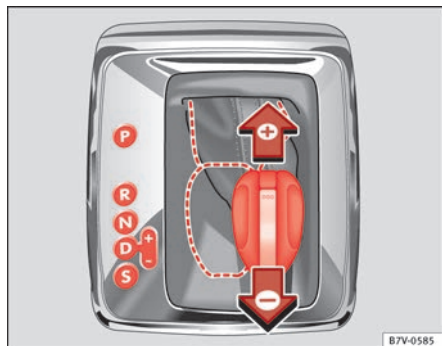

Fig. 133 Selector lever in Tiptronic position (left-hand drive vehicles). The lay-out in right-hand drive vehicles is symmetrically opposed.



Fig. 134 Steering wheel with two paddle shifts for Tiptronic.

The Tiptronic system allows you to manually change gears in vehicles with an automatic gearbox. When you change to the Tiptronic programme, the vehicle remains in the currently selected gear. This is possible as long as the system is not changing gear automatically due to a traffic situation.

Using Tiptronic with the selector lever

- Press the selector lever from position **D** to the right into the Tiptronic selector gate ⇒ Δ in Automatic gearbox*: Selecting gears on page 179.
- Press the lever forwards \oplus or backwards \ominus to move up or down a gear ⇒ fig. 133.

Using the Tiptronic with the steering wheel paddle shifts

- In **D** or **S**, move the steering wheel paddle shifts ⇒ fig. 134.
- Pull the right-hand side paddle \oplus OFF ⇒ fig. 134 towards the steering wheel to step up a gear.
- Pull the left-hand side paddle \ominus ⇒ fig. 134 towards the steering wheel step down a gear.

If the paddles are not used for a period of time, the vehicle leaves Tiptronic mode.



CAUTION

- When accelerating, the gearbox automatically shifts up into the next gear shortly before the maximum engine speed is reached.
- When reducing speed manually, the gear box only shifts gear when the engine can no longer exceed the maximum engine speed. ■

Driving with an automatic gearbox

The gearbox changes gear ratios automatically as the vehicle moves.

Driving down hills

The steeper the gradient, the lower the gear you will need. The lowest gears increase the engine braking work. Never go down hills with the selector lever in neutral **N**. ►

- You should reduce speed accordingly.
- Press the selector lever from position **D** to the right into the Tiptronic selector gate ⇒ page 180.
- Gently pull the selector lever back to change down a gear.
- **ALTERNATIVELY:** Reduce using the steering wheel paddles ⇒ page 180.

Emergency program

If all the selector lever positions on the instrument panel display are shown with a light-coloured background, this means there is a fault in the system. The automatic gearbox will operate in emergency programme mode. When the emergency program is activated, it is possible to drive the vehicle however, at low speeds and within a selected range of gears.

For the DSG® dual clutch gearbox, in some cases, this may mean that **the reverse gear does not engage**. The gearbox should be checked by a Technical Service as soon as possible.

Overload protection for the 6-speed DSG gearbox®

When the clutch is overloaded, the vehicle begins to *jerk* and the selector lever position indicator begins to flash. To prevent damage to the clutch, this interrupts the power transmission between the engine and the gearbox. There is no more traction and it is not possible to accelerate. If the clutch is opened automatically due to overloading, press the brake pedal. Wait a few seconds before starting to move again.

Kick-down

The kick-down system provides maximum acceleration when the gear selector lever is in the positions **D**, **S** or in the Tiptronic position.

When the accelerator pedal is pressed right down, the automatic gearbox will shift down to a lower gear, depending on road speed and engine speed. This takes advantage of the maximum acceleration of the vehicle ⇒ .

When the accelerator is pressed to the floor, the automatic gearbox shifts to the next gear only after the engine reaches the specified maximum engine speed.

Launch-Control Programme

The Launch-Control programme enables maximum acceleration while at a standstill.

- Deactivate the ASR (TCS) ⇒ page 183.
- Press and hold the brake pedal with your left foot.
- Place the selector lever in position **S** or Tiptronic.
- Press the accelerator with the right foot until the vehicle reaches an engine speed of approximately 3200 rpm.
- Lift the left foot off the brake ⇒ . The vehicle starts with maximum acceleration.
- Turn on the ASR (TCS) after accelerating!



WARNING

Rapid acceleration can cause loss of traction and skidding, especially on slippery ground. This could cause loss of control of the vehicle resulting in an accident and considerable damage.

- **Only use kick-down and rapid acceleration when weather conditions, surface conditions and traffic conditions permit; accelerate and drive in a manner that does not endanger other road users.**
- **Please remember that the drive wheels can slip and the vehicle can skid if the ASR (TCS) is turned off, especially on slippery ground.**
- **Turn on the ASR (TCS) after accelerating.**





CAUTION

- If you stop on a hill with a gear ratio engaged, do not try to prevent the vehicle from rolling back by pressing on the accelerator. This could cause overheating and damage the automatic gearbox.
- Never allow the vehicle to move with the gear selector lever in **N**, especially with the engine turned off. The automatic gearbox will not be lubricated and could be damaged.

Recommended gear indication

In some vehicles, the recommended gear for reducing fuel consumption is displayed on the instrument panel:

Display	Meaning
	Optimum gear.
	Recommendation to change up a gear.
	Recommendation to change down a gear.

Information for cleaning the diesel particulate filter

The exhaust gas system control recognises when the diesel particulate filter is blocked, and helps to clean it by recommending a specific gear for driving. It may therefore be necessary to drive with the engine at an exceptionally high speed ⇒ page 228.

WARNING

The recommended gear display is intended as a guideline only; it should never replace the driver's attention to driving carefully.

- **Responsibility for selecting the correct gear for each situation continues to lie with the driver, for example when overtaking, climbing a hill or towing a trailer.**



For the sake of the environment

Selecting the most appropriate gear for the situation will help you to save fuel.

Note

The recommended gear display is switched off when the clutch pedal is pressed. ■

Braking, stopping and parking

Introduction

The **assisted braking systems** include the anti-lock braking system (ABS), the brake assist system (BAS), the electronic differential system (EDS), the ASR traction control system (TCS) and the ESC electronic stabilisation program (ESP).

Additional information and warnings:

- Towing mode ⇒ page 233
- Start assist systems ⇒ page 194
- Wheels and tyres ⇒ page 293
- Accessories, parts replacement, repairs and modifications ⇒ page 257



WARNING

Driving with worn brake pads or a faulty brake system may lead to serious accident.

- If  lights, alone or accompanied by a warning message on the instrument panel, please go immediately to a specialist workshop to check the brake pads and to replace them if they are worn.



WARNING

Careless parking can cause serious injury.

- **Never remove the key from the ignition if the vehicle is in motion. The steering lock may engage and locked the steering wheel making the vehicle impossible to control.**

WARNING (Continued)

- **Always park your vehicle so that no part of the exhaust system can come in contact with flammable materials (such as wood, leaves, spilled fuel, dried grass, etc).**
- **Always apply the electronic parking brake when you leave your vehicle and when you park.**
- **Never leave children or disabled people alone in the vehicle. They could release the electronic parking brake, activate the selector lever or gear stick and start the vehicle moving. This could result in serious accident.**
- **Always take all the keys with you whenever you leave the vehicle. The engine could accidentally be started and electrical equipment such as the windows could accidentally be operated resulting in serious injury.**
- **Never leave children or disabled people alone in the car. They could be trapped in the car in an emergency and will not be able to get themselves to safety. For example, depending on the time of the year, temperatures inside a locked and closed vehicle can be extremely high or extremely low resulting in serious injuries and illness or even death, particularly for young children.**

CAUTION

- Special care should be taken when parking in areas with high kerbs or fixed barriers. Objects protruding from the ground may damage the bumper or other parts of the vehicle during manoeuvres. To avoid damage, stop before the wheels touched the barrier or kerb.
- Special attention is required when driving through entrances, over ramps, kerbs or other objects. The vehicle underbody, bumpers, mudguards and running gear, and the engine and exhaust system could be damaged as you drive over these objects.

Warning and control lamps

lights up	Possible cause ⇒ ⚠	Solution
Ⓜ (red)	Together with the control lamp Ⓜ on the button: Electronic parking brake on.	⇒ page 185
	Fault in the brake system	🛑 Stop the vehicle! Seek professional assistance! ⇒ page 187.
	Brake fluid level inadequate.	🛑 Do not drive on! Check brake fluid level ⇒ page 192.
	Together with the ABS control lamp Ⓜ: ABS fault.	Contact a specialist workshop. The vehicle can be braked without ABS.
🚗 (red)	Brake pedal not pressed!	Press brake pedal to the floor.
Ⓜ (yellow)	Front brake pads worn.	Contact a specialist workshop immediately. Inspect all the brake pads and replace as necessary.
🛑 (yellow)	ESC (ESP) disconnected by system.	Switching the ignition on and off. If necessary, drive for a short distance.
	Fault in ESC (ESP).	Contact a specialist workshop.
	Together with the ABS control lamp Ⓜ: Fault in ABS.	Contact a specialist workshop. The vehicle can be braked without ABS.
🔋 (yellow)	The battery has been reconnected.	⇒ page 288
	ASR (TCS) manually deactivated.	Turn on the ASR (TCS) ⇒ page 191. ASR (TCS) is automatically activated when the ignition is switched on or off.

lights up	Possible cause ⇒ ⚠	Solution
Ⓜ (yellow)	Together with the ESC (ESP) control lamp 🛑: Fault in ABS. Together with the warning lamp Ⓜ or 🛑: ABS fault.	Contact a specialist workshop. The vehicle can be braked without ABS.
🛑 (yellow)	Together with the warning lamp Ⓜ flashing: Electronic parking brake faulty.	Contact a specialist workshop.
🚗 (green)	Brake pedal not pressed.	Press the brake pedal to select a gear ratio.
		Press the brake pedal to disconnect the electronic parking brake ⇒ page 185.
flashes	Possible cause ⇒ ⚠	Solution
Ⓜ (red)	Electronic parking brake faulty. The control lamp 🛑 may light up at the same time or the control lamp Ⓜ may flash on the button.	Contact a specialised workshop, as it may not be possible to park the vehicle in safety.
🛑 (yellow)	ESC (ESP) or ASR (TCS) regulated.	Take your foot off the accelerator. Adjust your driving style to the road conditions.

Several warning and control lamps should light up for a few seconds when the ignition is switched. This signals that the lamp is working properly. They will switch off after a few seconds.





WARNING

If the warning lamps and messages are ignored, the vehicle may stall in traffic, or may cause accidents and severe injuries.

- **Never ignore the warning lamps or text messages.**
- **Stop the vehicle safely as soon as possible.**

WARNING

Driving with brakes in bad condition could result in a serious accident.

- If the brake warning lamp  does not go out, or if it lights up when driving, the brake fluid level in the reservoir is too low or there is a fault in the brake system. Obtain professional assistance immediately → page 191, Brake fluid.
- If the brake warning lamp  lights up together with the ABS warning lamp , the regulation function of the ABS could be malfunctioning. As a result, the rear wheels can lock relatively easily when braking. If the rear wheels lock this could result in loss of vehicle control! If possible, reduce your speed and drive carefully to a specialist workshop close by to check the brake system. During the following journey, avoid sudden braking and manoeuvres.
- If the ABS warning lamp  does not go out or if it lights while driving, the ABS is malfunctioning. The vehicle can only be stopped using normal braking without ABS. The protection provided by the ABS is not available. Visit a specialised workshop as soon as possible.
- If  lights, alone or accompanied by a warning message on the instrument panel screen, please go immediately to a specialist workshop to check the brake pads and to replace them if they are worn.

CAUTION

Failure to heed the warning lamps and text messages when they appear may result in faults in the vehicle.



Electronic parking brake





Fig. 135 Detailed view of the centre console: electronic parking brake switch

Applying the electronic parking brake

The parking brake can be applied whenever the vehicle is at a standstill, even when the ignition is switched off. Always apply the parking brake when you leave your vehicle and when you park.

- Pull button  until the control lamp  on the button lights up.
- The parking brake is applied when the control lamp  lights up on the instrument panel → page 184.

Releasing the electronic parking brake

- Switch the ignition on.
- Press button . At the same time, press the brake pedal hard or gently press the accelerator pedal with the engine switched on.
- The control lamps  on the button and  on the instrument panel go out.

Automatic release of the electronic parking brake on starting the engine

The electronic parking brake is automatically released when the vehicle starts moving, if the driver's door is closed **and** the driver is wearing his/her seat belt. In vehicles with a **manual gearbox** the clutch pedal should also be pressed to the floor before starting the engine so that the system recognises that the parking brake should be released.

Emergency braking function

Only use the emergency braking function if the vehicle cannot be stopped with the brake pedal ⇒ .

- Pull button  **hard** to stop the vehicle. The warning display will be accompanied by the corresponding warning chime.
- To stop the braking process, release the button or press the accelerator.



WARNING

The incorrect use of the electronic parking brake may result in serious accident.

- **Never use the electronic parking brake to brake the vehicle except in an emergency. The braking distance is considerably longer, because braking is only applied to the rear wheels. Always use the foot brake.**
- **Never accelerate from the engine compartment with the engine running and a gear or a gear range engaged. The vehicle could move, even if the parking brake is applied.**



Note

- In vehicles with a manual gearbox: When the clutch pedal is released and the accelerator pressed at the same time, the electronic parking brake is automatically released.
- If the vehicle battery is flat, it will not be possible to disconnect the electronic parking brake. Use the jump-start ⇒ page 337.

- When the electronic parking brake is applied or released, noises may be heard.
- If the electronic parking brake has not been used for a long while, the system sometimes performs automatic and audible checks while the vehicle is at a standstill. ■

Parking

When parking your vehicle, all legal requirements should be observed.

To park the vehicle

Complete operations only in the sequence given.

- Park the vehicle on a suitable surface ⇒ .
- Press and hold the brake pedal until the vehicle comes to a standstill.
- Connect the electronic parking brake ⇒ page 185.
- For an automatic gearbox, move the selector lever to position **P**.
- Switch off the engine and release the brake pedal.
- Remove the key from the ignition.
- If necessary, turn the steering wheel slightly to lock the steering.
- With a manual gearbox, engage the 1st gear on flat ground and slopes, or even the reverse gear on hills, and release the clutch pedal.
- Ensure that all passengers leave the vehicle, especially children.
- When leaving the vehicle, take all keys with you.
- Lock the vehicle.

Additional information for steep slopes and hills

Before switching off the engine, rotate the steering wheel so that if the vehicle should move then it will be held by the kerb. ►

- On slopes, turn the front wheels so that they are against the edge of the kerb.
- Uphill, turn the wheels towards the centre of the road.



WARNING

The components of the exhaust system reach very high temperatures. This could cause a fire and considerable damage.

- Always park your vehicle so that no part of the exhaust system can come in contact with flammable materials (such as wood, leaves, spilled fuel, dried grass, etc).



CAUTION

- Special care should be taken when parking in areas with high kerbs or fixed barriers. Objects protruding from the ground may damage the bumper or other parts of the vehicle during manoeuvres. To avoid damage, stop before the wheels touched the barrier or kerb.
- Special attention is required when driving through entrances, over ramps, kerbs or other objects. The vehicle underbody, bumpers, mudguards and running gear, and the engine and exhaust system could be damaged as you drive over these objects.

Information about the brakes

For the first 200 to 300 km (100 to 200 miles), **new brake pads** have not yet reached their maximum braking capacity, and need to be “run in” first ⇒ ⚠. The slightly reduced braking effect can be compensated for by increasing pressure on the brake pedal. **While running in, the full braking distance or emergency braking distance is larger** than when the brake pads have been run in. While running in, avoid full power braking or situations requiring braking performance. For example, in heavy traffic.

The **rate of wear of the brake pads** depends to a great extent on the conditions in which the vehicle is used and the way the vehicle is driven. If the vehicle is used frequently in city traffic or for short trips or driven sport style, visit a specialist workshop regularly more frequently than advised in the Maintenance Programme to have the brake pads checked.

If you drive with **wet brakes**, for example, after crossing areas of water, in heavy rainfall or even after washing the car, the effect of the brakes is lessened as the brake discs are wet or even frozen (in winter). At higher speed, dry the brakes as quickly as possible by braking gently several times. Only do this without endangering vehicles behind you or any other road users ⇒ ⚠.

A **layer of salt on the discs and brake pads** will reduce brake efficiency and increase braking distance. If you drive for a prolonged period on salted roads without braking then brake carefully several times to eliminate the layer of salt on the brakes ⇒ ⚠.

If the vehicle remains parked for considerable lengths of time, is used little, or if the brakes are not used, there may be **corrosion** on the brake discs and a buildup of **dirt** on the brake pads. If the brakes are not used frequently, or if rust has formed on the discs, SEAT recommends cleaning the pads and discs by braking firmly a few times at a moderately high speed. Only do this without endangering vehicles behind you or any other road users ⇒ ⚠.

Faults in the brake system

During braking, if you notice that the vehicle does not react as usual (that the braking distance has increased suddenly) it may be possible that there is a fault in the braking system. The Ⓞ warning lamp lights up and a text message displayed. Take the vehicle to a Technical Service immediately and have the fault repaired. Drive at a moderate speed and be prepared to use more pressure on the brake pedal, and allow for longer stopping distances.

Brake servo

The brake servo only operates when the engine is running and the pressure applied by the driver on the brake pedal increases. ▶

If the brake servo does not operate or the vehicle must be towed, then the brake pedal will have to be pressed with more force given that the braking distance will be increased when the brake servo does not operate ⇒ ⚠.

WARNING

New brake pads do not brake to full efficiency.

- For the first 320 km (200 miles), new brake pads have not yet reached their maximum braking capacity, and need to be run in first. For this, to compensate for reduced braking efficiency the brake pedal will have to be pressed with more force.
- To avoid losing control of the vehicle and causing serious accidents, always take great care when driving with new brake pads.
- When running in new brake pads, always respect the safety distances between you and other vehicles and do not cause situations requiring extreme braking performance.

WARNING

When brakes overheat, braking is less efficient and braking distances increase.

- When driving on slopes, brakes can be overloaded and overheat quickly.
- Reduce speed, move down a gear or select a shorter range of gears before long steep slopes. This allows you to use the engine braking effect and to reduce the strain on the brake system.
- Non-standard or damaged front spoilers could restrict the airflow to the brakes and cause them to overheat.

WARNING

Wet, frozen or salt-covered brakes take time to brake and this increases braking distances.

- Test the brakes carefully.
- Dry the brakes, free them of ice and salt by braking gently several times, when weather, road and traffic conditions permit.

WARNING

Driving without the brake servo may significantly increase the braking distance and result in a severe accident.

- Never allow the vehicle to move forwards when the engine is switched off.
- If the brake servo does not operate or the vehicle must be towed, then the brake pedal will have to be pressed with more force given that the braking distance will be increased when the brake servo does not operate.

CAUTION

- Never make the brakes slip by pressing the pedal gently, if it is not really necessary to brake. Continuously pressing on the brake pedal will heat the brakes. This could significantly reduce braking power, increase braking distance or even result in the total failure of the brake system.
- Reduce speed, move down a gear or select a shorter range of gears before long steep slopes. This allows you to use the engine braking effect and to reduce the strain on the brake system. Otherwise, the brakes may overheat and fail. Only use the brakes to reduce speed or to stop. ▶



Note

When checking the front brake pads, take the time to also check the rear brake pads. The thickness of the brake pads should be checked visually and regularly, by looking through the openings in the wheel rims or from underneath the vehicle. If necessary, remove the wheels to check them thoroughly. SEAT recommends visiting a Technical Service. ■

Assisted braking systems

The assisted braking systems ESC (ESP), ABS, BAS, ASR (TCS) and EDS only operate when the ignition is switched on. They contribute significantly to increasing active safety.

Electronic stability programme ESC (ESP)

ESC (ESP) reduces the risk of skidding and increases the vehicle stability by braking individual wheels under specific driving conditions. ESC (ESP) detects critical handling situations, such as understeer, oversteer and wheel-spin on the drive wheels. The system stabilises the vehicle by braking individual wheels or by reducing the engine torque.

The ESC (ESP) has limits. It is important to realise that the ESC (ESP) is also subject to the laws of physics. ESC (ESP) will not be able to deal with all situations with which drivers may be faced. For example, if the road surface changes suddenly then ESC (ESP) will not be useful in all cases. If the vehicle suddenly enters a section covered by water, mud or snow then ESC (ESP) will not provide assistance in the same way as on dry ground. If the vehicle loses its grip on the ground and moves on a film of water (“aquaplaning”), the ESC (ESP) will not be able to assist the driver to control the vehicle due to the loss of adherence with the road surface preventing braking and steering. If the vehicle is driven through series of bends at high speed, the ESC (ESP) will not always be as effective: the vehicle reaction to aggressive driving is not the same as at reduced speeds. When driving with a trailer, ESC (ESP) does not provide the same amount of vehicle control as without a trailer.

Adjust your speed and driving style to road, traffic and weather conditions. ESC (ESP) cannot push the limits of the laws of physics; improve the transmission available or maintain the vehicle on the road if a lack of driver attention creates an inevitable situation. Otherwise, ESC (ESP) assists in maintaining vehicle control in extreme situations and uses the movements of the steering made by the driver to maintain the vehicle moving in the desired direction. If the vehicle is driven at such a speed that it will leave the road before ESC (ESP) can intervene then the system cannot provide assistance.

The ABS, BAS, ASR (TCS) and EDS systems are incorporated into the ESC (ESP). The ESC (ESP) is always on. The ESC (ESP) should only be turned off using the ASR (TCS) button → [fig. 136](#) when traction is insufficient. Always remember to turn on the ASR (TCS) once more when the vehicle has traction once again.

Anti-lock brake system (ABS)

ABS can prevent the wheels from locking during braking until just before the vehicle stops thus helping the driver to steer the vehicle and maintain control. This means that, even during full braking, the risk of skidding is reduced:

- Press and hold the brake pedal fully. Do not remove your foot from the brake pedal or reduce braking force!
- Do not “pump” the brake pedal, or reduce braking force!
- Maintain vehicle direction when braking fully.
- When the brake pedal is released or when the brake force is reduced, ABS is turned off.

ABS control can be observed by **vibration of the brake pedal** and noise. You should never expect the ABS to reduce the braking distance under *any* circumstances. Braking distances will increase when driving on gravel, recent snow or on icy and slippery ground.

When driving on loose ground, the all-terrain configuration of the ABS is automatically turned on. When ABS is activated, the front wheels may lock briefly. This shortens the braking distance in off-road situations as the ▶

wheels are prevented from digging into loose surfaces. All-terrain ABS only intervenes when driving in a straight line. When the front wheels are turned, the normal ABS is activated.

Braking assist system (BAS)

The brake assist system may reduce the required braking distance. The brake assist system boosts the braking force if you press the brake pedal quickly in an emergency. As a result, the braking pressure increases rapidly, the braking force is multiplied and the braking distance is reduced. This enables the ABS to be activated more quickly and efficiently.

Do **not** lift your foot off the brake pedal! When the brake pedal is released or when the brake force is reduced, braking assist automatically turns off the brake servo.

Traction control when accelerating ASR (TCS)

In the event of wheelspin, the ASR (TCS) reduces the engine torque to match the amount of grip available. The ASR (TCS) makes some situations easier, for example, when starting, accelerating or going uphill, even in unfavourable road conditions.

The ASR (TCS) can be switched on or off manually ⇒ page 191.

Electronic differential lock system (EDS)

EDS is available when driving in straight lines under normal conditions. When the EDL detects wheelspin, it brakes the spinning wheel and directs the power to the other drive wheels. To prevent the disc brake of the braked wheel from overheating, the EDL cuts out automatically if subjected to excessive loads. The EDL will switch on again automatically when the brake has cooled down.

WARNING

Driving at high speed on icy, slippery wet ground can result in loss of vehicle control and serious injury to the driver and passengers.

- Adjust your speed and driving style to visibility, road, traffic and weather conditions. Even though the braking assist systems ABS, BAS, EDS, ASR (TCS) and ESC (ESP) provide more security, do not take unnecessary risks while driving.
- Braking assist systems can not overcome the laws of physics. Even with ESC (ESP) and other systems, slippery and wet roads will always be dangerous.
- Driving to quickly on wet ground can result in the wheels losing contact with the ground in an effect known as aquaplaning. Without adherence, it is impossible to brake, steer or control the vehicle.
- Braking assist systems cannot avoid accidents if, for example, the driver does not respect safety distances or drives to quickly in difficult conditions.
- Even though braking assist systems are extremely effective and help control the vehicle in difficult situations, remember that the vehicle stability depends on tyre grip.
- When accelerating on a slippery surface, for example on ice and snow, press the accelerator carefully. The wheels can still slip even with braking assist systems resulting in loss of vehicle control.

WARNING

The effectiveness of the ESC (ESP) can be considerably reduced if other components and systems affecting driving dynamics are not maintained or are not functioning correctly. This includes, among others, brakes, tyres and other systems already mentioned.

- Remember that changing and fitting other components to the vehicle can affect operation of the ABS, BAS, ASL EDL and ESC (ESP).

⚠ WARNING (Continued)

- **Changes to the vehicle suspension or using unapproved wheel/tyre combinations can affect operation of the ABS, BAS, ASL EDL and ESC (ESP) and their effectiveness.**
- **Likewise, the effectiveness of ESC (ESP) depends on the use of suitable tyres ⇒ page 293.**



Note

- To ensure that the ESC (ESP) and ASR (TCS) work properly, all four wheels must be fitted with identical tyres. Any differences in the rolling radius of the tyres can cause the system to reduce engine power when this is not desired.
- If a malfunction should occur in the ABS, the ESC (ESP), ASR (TCS) and EDS will also be affected.
- Noises may be heard while any of the above systems are operating. ■

Turning on and off the ASR (TCS)

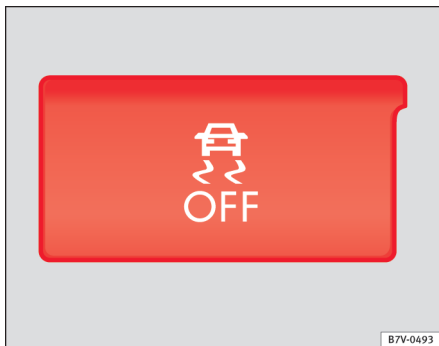



Fig. 136 Detailed view of the centre console: button used to switch ASR (TCS) on and off (vehicles with ESC (ESP)).

The electronic stabilisation control ESC (ESP) consists of ABS, EDL and ASR (TCS) and only works when the engine is running.

The ASR (TCS) can be switched off while the engine is running by pressing the  ⇒ fig. 136 button. The ASR (TCS) (and similar) is only switched off when the required traction is not obtained:

- When driving through deep snow or on loose ground (gravel...).
- When freeing a trapped vehicle.

Turn the ASR (TCS) back on by pressing the button  ⇒ fig. 136. ■

Brake fluid



Fig. 137 In the engine compartment: brake fluid reservoir, lid

In the course of time, the brake fluid absorbs water from the ambient air. If there is too much water contained in the brake fluid, the brake system could be damaged. In addition, the boiling point of the brake fluid is significantly lowered. When the brake fluid contains too much water and the brakes are subject to considerable forces, bubbles of water vapour can form in the system. These bubbles of water vapour can significantly reduce braking power, ►

notably increasing braking distance, and could even result in the total failure of the brake system. Ensuring that the brake system is always functioning correctly is essential for your own safety and the safety of other road users ⇒ .

Brake fluid specifications

SEAT have developed a special brake fluid optimised for the brake systems of their vehicles. To ensure the optimum working of the brake system, SEAT recommends the use of brake fluid in accordance with the **VW 501 14 standard**. If this brake fluid is not available or another brake fluid is used for different reasons, use a brake fluid that complies with the United States standard FMVSS 116 DOT 4 or the German standard DIN ISO 4925 CLASS 4 ⇒ .

Brake fluids conforming to the standard VW 501 14, fulfil the American requirements of the FMVSS 116 DOT 4 standard and the German DIN ISO 4925 CLASS 4 standard. However, fluids that comply with the American FMVSS 116 DOT 4 standard or the German DIN ISO 4925 CLASS 4 standard do not necessarily comply with the VW 501 14 standard. Always check the information on the brake fluid container and ensure that you are using suitable brake fluid.

A suitable brake fluid can be obtained from Authorised Service Centres.

Brake fluid level

The level of the brake fluid should always be between the MIN and MAX marks, or above the MIN mark ⇒ .

It is not always possible to check the level of the brake fluid, as in some models the engine components make it difficult to see the brake fluid reservoir. If you cannot read the exact brake fluid level, consult a specialist.

The brake fluid level drops slightly when the vehicle is being used due to wear of the brake pads and the automatic readjustment of the brake.

Changing the brake fluid

The brake fluid should be changed in accordance with the instructions given in the Maintenance Programme. Have the brake fluid changed by a Tech-

nical Service. SEAT recommends visiting a Technical Service. This means that only brake fluid complying with the required specifications will be used.



WARNING

If the brake fluid level is low or unsuitable/old brake fluid is used, the brake system may fail or braking power will be reduced.

- Check the brake system and the brake fluid level regularly!
- The brake fluid should be changed regularly in accordance with the instructions given in the Maintenance Programme.
- When the brake fluid is used and brakes are subjected to extreme braking forces, bubbles of vapour form in the brake system. These bubbles of water vapour can significantly reduce braking power, notably increasing braking distance, and could even result in the total failure of the brake system.
- Only used brake fluid that conforms to the VW 501 14 standard, FMVSS 116 DOT 4 standard or even the DIN ISO 4925 CLASS 4 standard. Other types of brake fluid could affect brake operation and reduce braking power. Do not use a brake fluid if the container does not specify compliance with the VW 501 14, FMVSS 116 DOT 4 or DIN ISO 4925 CLASS 4 standards.
- The replacement brake fluid must be new.
- Always ensure that you use suitable brake fluid. Do not use a brake fluid if the container does not specify compliance with the VW 501 14, FMVSS 116 DOT 4 or DIN ISO 4925 CLASS 4 standards.

**WARNING**

Brake fluid is poisonous.

- To reduce the risk of poisoning, do not keep brake fluid in drinks bottles/containers or similar. Other people could drink from these recipients even if the contents are clearly marked.
- Always keep brake fluid in the original container; keep it correctly sealed and out of reach of children.

**CAUTION**

Brake fluid could damage the paintwork. Wipe off any brake fluid from the paintwork immediately.

**For the sake of the environment**

Brake fluid is an environmental pollutant. Collect any spilt service fluids and allow a professional to dispose of them. ■

Start assist systems

Introduction

Additional information and warnings:

- SEAT information system ⇒ page 62
- Braking, stopping and parking ⇒ page 183
- Vehicle battery ⇒ page 288
- Wheels and tyres ⇒ page 293
- Accessories, parts replacement, repairs and modifications ⇒ page 257
- Jump starting ⇒ page 337

WARNING

The intelligent technology in the start assist systems cannot change the laws of physics. The improved comfort provided by start assist systems should not prompt you to take risks.

- Unintentional movements of the vehicle could cause serious injury.
- The start assist systems are not a replacement for driver awareness.
- Always try to adapt the speed of the vehicle and your style of driving to the condition of the ground or the road and to weather and traffic conditions.
- The start assist system cannot keep the vehicle stationary in all conditions on a gradient or cause it to brake on steep downhill gradients, e.g. if the road is slippery or icy.

Auto Hold function*



Fig. 138 Detailed view of the centre console: Auto Hold button.

The control lamp on the button switches on when the Auto Hold function is on.

When the Auto Hold function is on, it helps the driver if they must regularly stop the vehicle or if they must stop with the engine running for prolonged periods, for example, on hills, before a traffic light or in traffic jams with continuous stopping and starting.

The Auto Hold function automatically prevents the vehicle from rolling away accidentally when at a standstill, without the driver having to keep his/her foot on the brake pedal.

When the system that detects that the vehicle has stopped, the Auto Hold keeps the vehicle at a standstill. The brake pedal can be released.

If the driver presses the brake pedal briefly or presses the accelerator to start off, the Auto Hold function releases the brake once more. The vehicle moves according to the gradient.

If any of the conditions necessary for the Auto Hold function change while the vehicle stopped, the system is turned off as is the indicator on the button ⇒ fig. 138. The electronic parking brake engages where necessary to park the vehicle safely ⇒ .

Conditions for keeping the vehicle at a standstill with Auto Hold:

- The driver's door must be closed.
- The driver's seat belt must be buckled.
- The engine must be running.
- The ASR (TCS) system must be switched on ⇒ page 183.

Switching Auto Hold on and off manually

Press the **AUTO HOLD** button ⇒ . The control lamp on the button switches off when the Auto Hold function is switched off.

Permanent Auto Hold connection

The Auto Hold function must be switched on every time the engine is started. However, to switch the Auto Hold function on permanently, the **mark** must be switched on in the **Settings** menu, "Autohold" submenu ⇒ page 62.

Auto Hold works automatically under the following conditions:

All points must be fulfilled simultaneously ⇒ .

manual gearbox	Automatic gearbox
1. If the vehicle is stopped using the brake pedal on a flat or slope.	
2. The engine must be running smoothly.	
3. On a slope, the 1st gear is engaged uphill or the reverse gear is engaged for a downhill. The clutch must be held down.	A gear for driving is selected from R, D or S .
Upon accelerating and pressing in the clutch simultaneously, the brake releases gradually.	Upon accelerating, the brake releases gradually.

Auto Hold turns off automatically under the following conditions:

manual gearbox	Automatic gearbox
1. If one of the conditions mentioned in table on page 195 changes.	
2. If the engine is not running regularly or if there is a malfunction.	
3. When changing to idle speed.	If the selector lever is placed in neutral (N).
4. If the engine is turned off or stalls.	If the engine is switched off.
5. If the driver accelerates while pressing the clutch in.	If the vehicle is accelerated.
6.	When one of the wheels has minimal contact with the ground (for example, on uneven ground).



WARNING

The Auto Hold technology is limited by the laws of physics. The improved comfort provided by Auto Hold should never prompt you to take risks.

- **Never leave the vehicle running and with the Auto Hold function switched on.**
- **Auto Hold cannot always stop the vehicle uphill and downhill (for example, if the ground is slippery or frozen).**



CAUTION

Before entering an automatic car wash, **always** switch the Auto Hold function off, as it could be damaged when the electronic parking brake automatically engages. ■

Start-Stop Function*

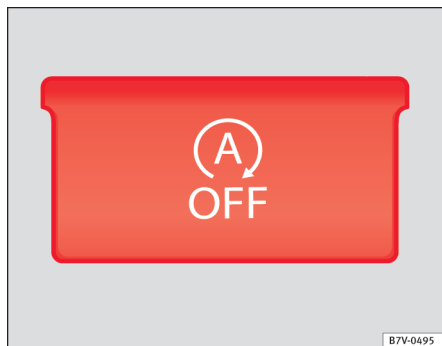

Fig. 139 Detailed view of the centre console: Start-Stop function button.

In Start-Stop mode, the engine is automatically switched off when the vehicle is at a standstill. The engine restarts automatically when required.

The function is enabled automatically whenever the ignition is switched on. The instrument panel displays information on the current status.

Vehicles with a manual gearbox

- When the vehicle is at a standstill, leave it in neutral and take your foot off the clutch. The engine switches off.
- Simply depress the clutch pedal to move off again.

Vehicles with an automatic gearbox

- When the vehicle is at a standstill, depress the brake or keep it pressed down. The engine switches off.
- The engine will start again as soon as you release the brake pedal.
- With the gear lever set to **P**, the engine will not start until a range of gears is selected or the accelerator pedal is depressed.

Important conditions for the engine to automatically switch off

- The driver seat belt must be buckled.
- The driver door must be closed.
- The bonnet must be closed.
- The factory-fitted towing bracket must not be electrically connected to a trailer.
- A minimum engine temperature has been reached.
- The vehicle has moved since the last stop.
- In vehicles with Climatronic: The temperature inside the vehicle is within the preset temperature range.
- The temperature set is neither very high nor very low.
- The air conditioning defrost function is not switched on.
- In vehicles with Climatronic: the blower has not been manually set to a high speed.
- The power level of the vehicle's battery is sufficient.
- The vehicle's battery temperature is neither too high nor too low.
- The vehicle is not on a steep gradient or slope.
- The front wheels are not overly turned.
- The heated windscreen is not switched on.
- Reverse gear is not engaged.
- The park assist system is not switched on.

Conditions for automatically restarting the engine

The engine may automatically restart under the following conditions:

- If the vehicle interior is too hot or too cold.
- If the vehicle moves.
- If the vehicle's battery voltage drops.

Conditions requiring the key to restart the engine

The engine must be started using the key under the following conditions: ►

- If the driver unbuckles his/her seat belt.
- If the driver's door is opened.
- If the bonnet is opened.
- In vehicles with a manual gearbox: If a gear has been selected.

Switching Start-Stop mode on and off manually

- Press the  button on the centre console => fig. 139.
- The button will light up when the Start-Stop function is switched off.

The engine will start immediately if the vehicle is in Stop mode when it is switched off manually.



WARNING

The brake servo and the power steering do not work when the engine is switched off.

- **Never allow the vehicle to move when the engine is switched off.**



CAUTION

Using the Start-Stop function for a long period at very high outdoor temperatures could damage the vehicle's battery.



Note

In some cases, you may have to restart the vehicle using the key. Observe the corresponding message on the instrument panel display. ■

Parking sensor system*

Introduction

The parking sensor system assists the driver when parking. When the vehicle approaches an obstacle, forwards or backwards, an intermittent sound will be heard, higher or lower depending on the distance. The shorter the distance, the shorter the intervals between tones. If the vehicle is too close to the obstacle, the sound signal becomes constant.

If you continue to approach an obstacle when the sound is continuous, this means the system can no longer measure the distance.

The sensor system on the bumpers transmit and receive ultrasound. Using the ultrasound signal (transmission, reflection from the obstacle and reception), this system continuously calculates the distance between the bumper and the obstacle.

Additional information and warnings:

- Park Assist system ⇒ page 202
- Accessories, parts replacement, repairs and modifications ⇒ page 257

WARNING

The parking sensor system and the optical parking system cannot replace driver awareness.

- **The sensors have blind spots in which obstacles and people are not registered.**
- **Always observe the area around the vehicle, as the sensors do not always detect small children, animals or objects.**

WARNING (Continued)

- **The surface of certain objects and some clothing do not reflect the ultrasound signals from the parking distance system. The system cannot detect or incorrectly detects these objects and people wearing these types of clothes.**
- **External sound sources can affect the parking distance aid signals. In this case, under certain circumstances, people and objects will not be detected.**

CAUTION

- The sensors may not always be able to detect objects such as trailer draw bars, thin rails, fences, posts, trees and open boots, etc. This could result in damage to your car.
- Although the parking sensor system detects and warns of the presence of an obstacle, the obstacle could disappear from the angle of measurement of the sensors if it is too high or low and the system would no longer indicate it. Therefore, it will not warn you of these objects. Ignoring the warnings of the parking sensor system could cause considerable damage to the vehicle.
- The bumper sensors may become damaged or misaligned, for example, when parking.
- To ensure that the system works properly, the bumper sensors must be kept clean, free of ice and snow and uncovered.
- When cleaning the sensors with high-pressure or steam cleaning equipment, spray the sensors briefly at a distance of no less than 10 cm (4 inches).

Note

Acoustic sources may lead to erroneous warnings on the parking sensor system, e.g. rough tarmac, cobbles or the noise of other vehicles. ■

Parking sensor system*



Fig. 140 Detailed view of the centre console: button for switching the parking sensor system on and off.

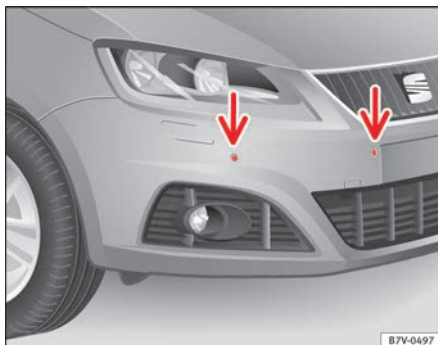



Fig. 141 Parking sensor system sensors on the front bumper.

The parking sensor system assists the driver when parking. If the vehicle is approaching an obstacle, an intermittent sound signal is emitted. The shorter the distance, the shorter the intervals between tones. If the vehicle is too close to the obstacle, the sound signal becomes constant.

Switching the parking sensor system on and off

- Press the  button ⇒ fig. 140 when the ignition is switched on.
- *Automatic on:* select reverse gear.
- *Automatic off:* drive faster than 15 km/h.

The button lights up when the function is switched on.

Things to note regarding the parking sensor system

- The parking sensor system sometimes registers water on the sensors as an obstacle.
- If the distance does not change, the warning signal will sound less loudly after a few seconds. If the continuous signal sounds, the volume will remain constant.
- When the vehicle moves away from the obstacle, the beeping sound automatically switches off. On approaching the obstacle again, the beeping sound will automatically switch back on.
- If the electronic parking brake is engaged or the gear lever is set to **P**, no sound will be emitted.
- Your Authorised Service Centre can adjust the volume of the warning signals.



Note

If the parking sensor system is faulty, a constant acoustic signal will be emitted the first time it is switched on and the button will flash. Switch the parking sensor system off using the button and take the vehicle to a specialist workshop to have the system checked as soon as possible. ■

Optical parking system* (OPS)

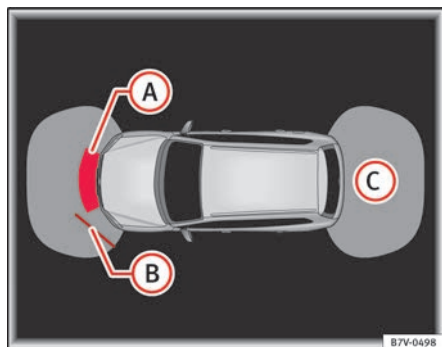

Fig. 142 On-screen OPS display: (A) an obstacle has been detected in the collision zone. (B) an obstacle has been detected in the segment. (C) zone recorded behind the vehicle.

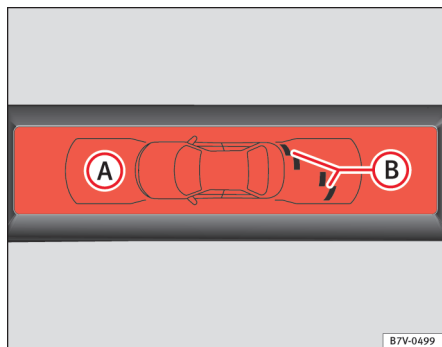





Fig. 143 On-screen OPS display: (A) an obstacle has been detected in the segment. (B) zone recorded behind the vehicle.

The optical parking system is an accessory to the Parking sensor system → page 199 and the park assist system → page 202.

The zone recorded by the sensors in front of and behind the vehicle is displayed on the factory-fitted radio or navigation system screen. Any obstacles are displayed in relation to the vehicle → .

Function	Necessary operations
Switching the display on:	Switch on the parking sensor system → page 199 or the park assist system → page 202. The OPS switches on automatically.
Switching the display off manually:	Press a zone selection button on the factory-fitted radio or navigation system OR: Briefly press the function button  or  on the screen.
Switching the display off manually:	Drive forwards at more than about 10-15 km/h. Select the reverse gear on vehicles with rear assist → page 207. The display changes to the image of the camera.

Zones explored

The zone in which obstacles are recognised runs to a distance of around 120 cm from the front of the vehicle and up to 60 cm to the side → fig. 143 (B). Behind the vehicle, the zone analysed reaches a distance of up to 160 cm and around 60 cm to the sides → fig. 142 (C).

Screen display

The image displayed represents the supervised zones in several segments. As the vehicle moves closer to an obstacle, the segment moves closer to the vehicle displayed (B) and → fig. 143 (A). When the penultimate segment is displayed, this means that the vehicle has reached the collision zone. **Stop the vehicle!** ▶

Distance from the vehicle to the obstacle	Acoustic signal	Displayed in colour on the screen: colour of the segment if an obstacle is recognised
in front: approx. 31 – 120 cm behind: approx. 31 – 160 cm	beeping sound	Yellow
approx. 0 – 30 cm in front or behind ^{a)}	permanent sound	Red

^{a)} The permanent sound starts at a somewhat greater distance on vehicles with a factory-fitted towing bracket.

With towing bracket

A specific image is displayed on the screen of vehicles with a factory-fitted towing bracket and an electrically connected trailer. In this case, the distances behind the vehicle are not indicated.

Switching the parking sensor system sound on and off

If the  button on the radio or navigation system screen may mute the sound of OPS warnings. To switch the warnings back on, press the button again briefly.

When the OPS is switched off and back on again, muting is cancelled. Error messages cannot be switched off.



WARNING

Do not be distracted from the traffic when looking at the screen.

Park Assist system*

Introduction

The Park Assist system helps the driver to find a suitable place to park, to insert the vehicle into parallel and perpendicular parking places and to leave parallel parking places.

The Park Assist system is limited to the system abilities and requires that the driver is especially attentive ⇒ .

The parking sensor system is a component of the Park Assist system that helps to park the vehicle.

For vehicles with the optical parking system, the radio navigation systems screen displays the detected zones in front of and behind the vehicle, indicating - within the limits of the system - the position of obstacles compared to the vehicle.

The park assist system cannot be switched on if the factory-fitted towing bracket is electrically connected to a trailer.

Additional information and warnings:

- Braking, stopping and parking ⇒ page 183
- Parking sensor system ⇒ page 198
- Caring for and cleaning the vehicle exterior ⇒ page 242
- Accessories, parts replacement, repairs and modifications ⇒ page 257

WARNING

Despite the assistance provided by the park assist system, do not run any risks when parking. The system is not a replacement for driver awareness.

- Unintentional movements of the vehicle could cause serious injury.
- Adjust your speed and driving style to visibility, road, traffic and weather conditions.
- The surface of certain objects and items of clothing and external sound sources may have a negative affect on the park assist signals or on the system sensors or may not reflect its signals.
- The sensors have blind spots in which obstacles and people are not registered.
- Always observe the area around the vehicle, as the sensors do not always detect small children, animals or objects.

CAUTION

- The park assist system aims exclusively at other parked vehicles, without taking curbs or other circumstances into account. Make sure you do not damage the tyres and wheel rims when parking. Where necessary, stop manoeuvring to avoid damaging the vehicle.
- The sensors may not always be able to detect objects such as trailer draw bars, thin rails, fences, posts and trees, etc. This could result in damage to your car.
- Although the parking sensor system detects and warns of the presence of an obstacle, the obstacle could disappear from the angle of measurement of the sensors if it is too high or low and the system would no longer indicate it. Therefore, it will not warn you of these objects. Ignoring the warnings of the parking sensor system could cause considerable damage to the vehicle. This is also valid when using the park assist (e.g. to park behind a truck or motorcycle). Therefore, always keep a close watch on the area in front of and behind the vehicle while parking, and intervene promptly if necessary. 

- To ensure that the system works properly, the bumper sensors must be kept clean, free of ice and snow and uncovered.
- The bumper sensors may become damaged or misaligned, for example, when parking.
- When cleaning the sensors with high-pressure or steam cleaning equipment, spray the sensors briefly at a distance of no less than 10 cm.



Note

Contact a specialist workshop with any system faults. SEAT recommends visiting a Technical Service. ■

Parking using the park assist system



Fig. 144 Detailed view of the centre console: button to switch the park assist system on manually.

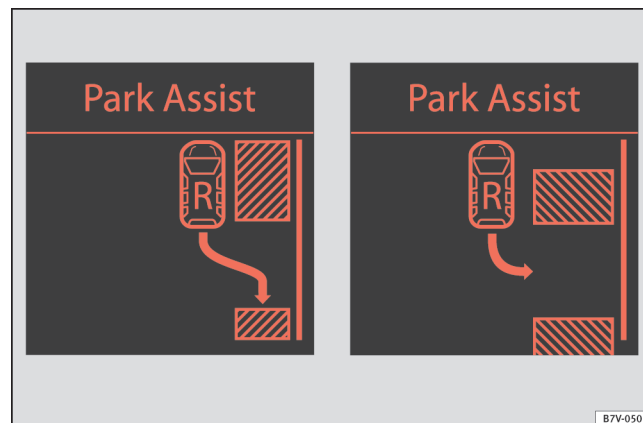





Fig. 145 Gap detected: Engage the reverse gear to park (parallel or nose/tail to the kerb).

Preparing to park



- The traction control system ASR (TCS) must be turned on ⇒ page 183.
- **Parallel parking:** press the button  at speeds up to 50 km/h **once**. When the function is enabled, the button ⇒ fig. 144 will light up.
- **Perpendicular parking:** press the button  at speeds up to 50 km/h **twice**. When the function is enabled, the button ⇒ fig. 144 will light up.
- If necessary, press the  button once more to change parking mode.
- Apply the turn signal indicator for the side on which a gap is to be detected for parking. The instrument panel displays the side corresponding to the road. ▶

Parking

- **Parking parallel to the road:** Drive next to the gap at a speed of no more than 40 km/h **and** at a distance of between 0.5 m and 2 m.
- **Parking perpendicular to the road:** Drive next to the gap at a speed of no more than 20 km/h **and** at a distance of between 0.5 m and 2 m.
- The best parking results will be achieved if you position the vehicle as parallel as possible to the line of parked cars or the kerb.
- When a suitable parking place is displayed on the instrument panel, stop and select reverse gear.
- Follow the instructions given on the instrument panel display
- Then, release the steering wheel when the warning signal sounds ⇒ : **The system will move the steering wheel! Observe the surrounding area.**
- Observe the surrounding area and accelerate carefully at a maximum of up to 7 km/h.
- The park assist system is **only** responsible for moving the steering wheel during the manoeuvre. **The driver applies the accelerator, the clutch, the gears and the brake.**
- Follow the instructions given by the park assist system until the manoeuvre is completed.
- The park assist system steers the vehicle forwards and backwards until it is in a straight position in the parking space.
- The manoeuvre is complete when the corresponding indication is given on the instrument panel display.

Stopping the parking manoeuvre

The park assist system stops the manoeuvre in the event of one of the following:

- Press button .
- Driving faster than 7 km/h.
- The driver moves the steering wheel.
- The parking manoeuvre has not been completed after six minutes since the park assist system was activated.
- A sliding door is opened. To restart the manoeuvre, close the sliding door and press the button  again.
- There is a system malfunction (system temporarily unavailable).
- The ASR (TCS) system is switched off or the ASR (TCS) or ESC (ESP) is working.





WARNING

The steering wheel turns quickly by itself when parking using the park assist system. Placing your hand between the steering wheel spokes could lead to injuries.





Note

- The park assist system has its limitations. For example, it is not possible to park on tight bends using the park assist system.
- Even if the park assist system recognises that there is not enough space for parking the vehicle, the display screen on the instrument panel will still display this place. In this case, the parking manoeuvre should not be requested.
- Changing gears between forward and reverse gears before indicated (that is, before the signal from the parking sensor system) the parking results may not be ideal.
- For parallel parking (parallel to the road), a sound will tell the driver when they must change from forward gears to reverse; the signal from the parking sensor system does not indicate changes of direction.
- The park assist can also be activated afterwards, if you pass close to a parallel parking space at a maximum of 40 km an hour or close to be perpendicular parking space at about 20 km an hour then press the button .
- The progress bar on the screen of the instrument panel shows a display of the relative distance to be covered.
- When the Park Assist system is turning the steering wheel of the stopped vehicle the symbol  is also displayed. Press on the brake pedal so that the steering can turn with the vehicle at a standstill and thus reduce the number of manoeuvres.

- A suitable parking space length is at least 1.1 m greater than the length of the vehicle.
- If the results of the park assist system are not as good after changing the wheels, the system must memorise the perimeter of the new wheels. This process is performed automatically while the vehicle is in motion. To help this process, turn slowly (at less than 20 km/h), e.g. in an empty car park.

Leaving a parking space using the Park Assist system

Driving off

- Switch on the engine.
- Press button . When the function is enabled, the button \Rightarrow fig. 144 will light up.
- Apply the turn signal indicator for the side on which you want to leave the parking space.
- Select reverse gear.
- Follow the instructions given by the park assist system.
- When the next indication appears, release the steering wheel \Rightarrow  in Parking using the park assist system on page 204: **The system will move the steering wheel! Observe the surrounding area.**
- Observe the surrounding area and accelerate carefully at a maximum of up to 7 km/h.
- The park assist system is **only** responsible for moving the steering wheel during the manoeuvre. **The driver applies the accelerator, the clutch, the gears and the brake.**
- When it is possible to leave the parking space, the Park Assist system will stop. Take control of the steering and when traffic conditions permit, leave the parking space.

Automatic stoppage of the manoeuvre

The park assist system stops the manoeuvre in the event of one of the following:

- Driving faster than 7 km/h.
- The driver moves the steering wheel.
- A sliding door is opened. To restart the manoeuvre, close the sliding door and press the button  again.
- There is a system malfunction (system temporarily unavailable).
- The ASR (TCS) system is switched off or the ASR (TCS) or ESC (ESP) is working.



WARNING

The steering wheel turns quickly automatically when leaving a parking space using the park assist system. Placing your hand between the steering wheel spokes could lead to injuries.

Park Assist brake operation

The Park Assist system helps the driver by braking automatically. Automatic braking does not relieve the driver of responsibility for controlling the accelerator, brake and clutch \Rightarrow .

Braking to avoid damage at excess speed

It is possible that the system operates the brakes to reduce excess speed. The parking manoeuvre can then continue. The brakes will intervene during each parking process.

Braking to minimise damage

When approaching an obstacle, the vehicle may brake automatically. In certain circumstances (for example, storm, detection of ultrasounds, vehicle 

status, load, inclination), the Park Assist system may stop the vehicle completely before an object.

- Press the foot brake ⇒ ⚠!

Following the intervention of the brakes, the Park Assist will stop.



WARNING

Despite the assistance provided by the park assist system, do not run any risks when parking. The system is not a replacement for driver awareness.

- **Always be ready to brake.**
- **Automatic brake intervention will end after 1.5 seconds approximately. Following automatic intervention of the brakes, stop the vehicle yourself.**

Rear Assist system*

Introduction

The camera fitted to the tailgate helps drivers during parking or reversing manoeuvres. The camera image and certain orientation points generated by the system are indicated on the factory-fitted radio or navigation system screen.

Two types of location point (modes) can be selected:

- **Mode 1:** reverse parking perpendicular to the road (e.g. in a car park).
- **Mode 2:** reverse parking parallel to the curb.

The mode can be changed by pressing the button on the radio or navigation system screen. Only the mode to which the points can be changed will be displayed.

Additional information and warnings:

- Accessories, parts replacement, repairs and modifications ⇒ page 257

WARNING

Use of the camera to calculate the distance from obstacles (people, vehicles, etc.) is inaccurate and may cause accidents and severe injuries.

- **The camera lens expands and distorts the field of vision and displays the objects on the screen in a different, vague manner.**
- **Some objects may not be displayed or may not be very clear (e.g. very thin posts or fences), due to the resolution of the monitor or if the light is dim.**
- **The camera has blind spots in which obstacles and people are not registered.**
- **Keep the camera lens clean and clear of snow and ice. Do not cover it.**

WARNING

The intelligent technology in the rear assist system cannot change the limits imposed by the laws of physics and by the system itself. Careless or uncontrolled use of the rear assist system may result in severe injuries and accidents. The system is not a replacement for driver awareness.

- **Adjust your speed and driving style to visibility, road, traffic and weather conditions.**
- **Always keep a close eye on the area around the vehicle and always look towards where you are parking. The display shows the path of the rear end of the vehicle using the current steering angle. The front of the vehicle turns more in comparison with the rear.**
- **Do not be distracted from the traffic when looking at the screen.**
- **Always observe the area around the vehicle, as the cameras do not always detect children, animals or objects.**
- **The system might not show all areas clearly.**
- **Only use the rear assist system when the tailgate is completely closed.**

CAUTION

- The camera only displays 2D images on the screen. Due to the lack of depth, it might be difficult or impossible to recognise protruding objects or cracks in the road.
- The cameras may not always be able to detect objects such as thin rails, fences, posts and trees, etc. This could result in damage to your car. ■

User instructions



Fig. 146 On the boot lid: location of the rear assist camera.

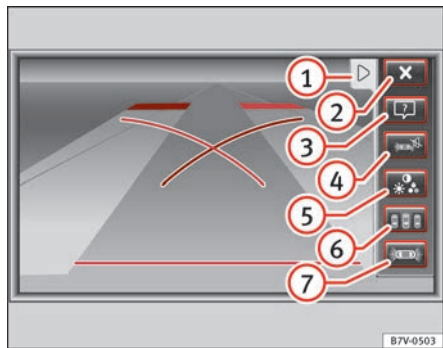

Fig. 147 Rear assist display: mode 2 connected.

Function buttons on the screen:

- ① ◀ display the menu; ▶ hide the menu.
- ② ✕ Turning off the reversing camera images

- ③ Display help. The help list explains the surfaces and lines on the camera image. Press ↵ to exit help.
- ④ Mute the sound.
- ⑤ Adjust the display: brightness, contrast, colour.
- ⑥ Switching on the orientation points for rear parking perpendicular to the road (mode 1).
- ⑦ Displaying the optical parking system.

Function	Operations in vehicles with no optical parking system (OPS)	Operations in vehicles with the optical parking system (OPS)
Switching the display on automatically:	select reverse gear with the ignition switched on or the engine running. Mode 1 will be displayed.	
Switching the display off manually:	Press a button to select the area on the radio or the navigation system ⇒ Booklet Radio or ⇒ Booklet Navigation system.	
	ALTERNATIVELY: Press the button on the screen.	
	ALTERNATIVELY: After switching off the ignition, the rear assist image remains on the screen for a short period.	
	Press button .	
Switching off the display by disengaging reverse gear:	The image will switch off after around 10 seconds.	The OPS display will immediately be shown.
Switching off the display by driving forwards:	Drive forwards at more than approx. 15 km/h.	Drive forwards at more than approx. 10 km/h. ▶

Things to note

1) Do not use the rear assist system in the following cases:

- If there is a fault in the dynamic chassis control (DCC).
- If the image displayed is not very clear or reliable (low visibility or dirty lens).
- If the space behind the vehicle cannot be clearly or completely recognised.
- If the vehicle has been overloaded at the rear.
- If the driver is not familiar with the system.
- If the tailgate is open.
- If the position and installation angle of the camera have been changed, e.g. in a rear-end collision. Have a specialised workshop check the system.

2) Optical illusions of the camera (examples)

The rear assist camera produces two-dimensional images. Any cracks in or objects protruding from the ground or from other vehicles are more difficult to spot or cannot be seen due to a lack of depth in the image displayed.

Objects or other vehicles may seem to be closer or further away than what they really are:

- On changing from a flat surface to a slope or gradient.
- On changing from a slope or gradient to a flat surface.
- If the vehicle has been overloaded at the rear.
- On approaching protruding objects. These objects may be outside the angle of vision of the camera when reversing.

Cleaning the camera lens

Keep the camera lens clean and clear of snow and ice:

- Moisten the lens using a commercially available, alcohol-based glass cleaning agent and clean the lens with a dry cloth ⇒ ⚠.
- Remove snow using a small brush.
- Use de-icing spray to remove any ice ⇒ ⚠.

⚠ CAUTION

- Never use abrasive cleaners to clean the camera lens.
- Never remove snow or ice from the camera lens using warm or hot water. This could damage the lens.

i Note

- SEAT recommends that you practise parking with the rear assist system in a quiet location or in a car park to become familiar with the system, including the orientation lines and their function.
- The orientation lines will not be displayed on the screen if the tailgate is open or the factory-fitted towing bracket is electrically connected to a trailer. ■

Parking perpendicular to the road (mode 1)

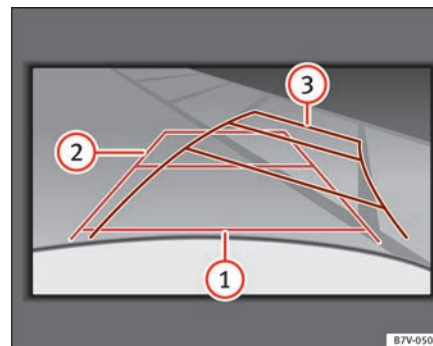

Fig. 148 Display: orientation lines for the parking space behind the vehicle. ▶

Summary of the orientation points

Meaning of orientation lines displayed on the screen ⇒ fig. 148. All of the lengths of the orientation lines use a vehicle located on a horizontal surface as reference.

- ① Red Safety distance: road area located up to around 40 cm behind the vehicle.
- ② Green: prolongation of the rear of the vehicle (somewhat enlarged). The area displayed green ends around two metres behind the vehicle, on the road.
- ③ Yellow: prolongation of the rear of the vehicle as the steering wheel turns. The area displayed yellow ends around three metres behind the vehicle, on the road.

Parking the vehicle

- Stop the vehicle in front of a space and select reverse gear.
- Reverse slowly and turn the steering wheel so that the yellow orientation lines guide you towards the space ③.
- Align the vehicle straight in the parking place using the help of the green orientation lines.

Parking parallel to the road (mode 2)

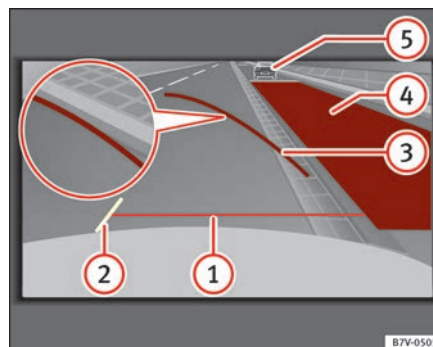

Fig. 149 Display: orientation lines and surfaces for the space behind the vehicle.

After applying the turn signal indicator, the lines and surfaces not required are deleted.

Summary of the orientation points

Meaning of orientation lines and surfaces displayed on the screen ⇒ fig. 149. All of the lengths of the orientation lines use a vehicle located on a horizontal surface as reference.

- ① Safety distance: road area located up to around 40 cm behind the vehicle.
- ② Vehicle side limit.
- ③ Turning point when parking. When the yellow line touches the curb or another limit of the parking space, the point for changing direction (magnifying glass) will have been reached.
- ④ Free space required to park the vehicle parallel. The surface displayed must completely fit in the space.
- ⑤ Possible vehicle parked next to the curb.

Parking the vehicle

- Stop the vehicle 1 m away parallel to the parking space and select reverse gear.
- Switch on mode 2 on the navigation system screen for parallel parking.
- Slowly reverse and turn the steering wheel so that the surface displayed yellow on the screen stops in front of any obstacles ⑤ (e.g. another vehicle).
- Turn the steering wheel fully towards the space and reverse slowly.
- When the yellow line ③ touches the side limit of the space, e.g. the border or curb (magnifying glass), turn the steering wheel fully in the opposite direction.
- Continue reversing until the vehicle is inside the space, parallel to the road. Correct the position if necessary. ■

Cruise control system*

Introduction

The cruise control system (CCS) is able to maintain the set speed when driving forwards from approx. 20 km/h (12 mph).

The CCS only slows down by reducing the accelerator but not by braking.
⇒ .

Additional information and warnings:

- Changing gear ⇒ page 174
- Accessories, parts replacement, repairs and modifications ⇒ page 257

WARNING

Use of the cruise control could cause accidents and severe injuries if it is not possible to drive at a constant speed maintaining the safety distance.

- **Do not use the CCS in heavy traffic, if the distance from the vehicle in front is insufficient, on steep roads, with several bends or in slippery circumstances (snow, ice, rain or loose gravel), or on flooded roads.**
- **Never use the CCS when driving off-road or on unpaved roads.**
- **Always adapt your speed and the distance to the vehicles ahead in line with visibility, weather conditions, the condition of the road and the traffic situation.**
- **To avoid unexpected operation of the cruise control system, turn it off every time you finish using it.**
- **It is dangerous to use a set speed which is too high for the prevailing road, traffic or weather conditions.**
- **When travelling down hills, the CCS cannot maintain a constant speed. The vehicle tends to accelerate under its own weight. Select a lower gear or use the foot brake to slow the vehicle.**

Warning and control lamp

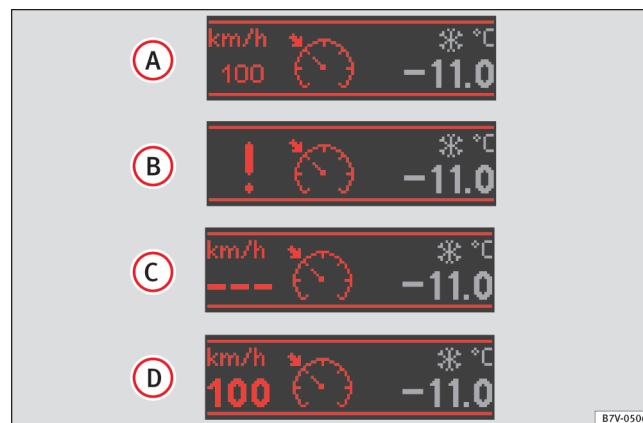



Fig. 150 Dash panel display: CCS status indications.

lights up	Possible cause	Solution
	This cruise control system maintains the set speed of the vehicle.	–

Several warning and control lamps should light up for a few seconds when the ignition is switched. This signals that the lamp is working properly. They will switch off after a few seconds.

Indication on display

There are different versions of the cruise control system. In vehicles with the multifunction display (MFI), the set speed is displayed on the instrument panel screen.

Status fig. 150:

- Ⓐ CCS temporarily switched off. The set speed is displayed in small figures.
- Ⓑ System error. Contact a specialist workshop.
- Ⓒ CCS switched on. The speed memory is empty.
- Ⓓ The CCS is switched on. The set speed is displayed in large figures.

⚠ WARNING

If the warning lamps and messages are ignored, the vehicle may stall in traffic, or may cause accidents and severe injuries.

- Never ignore the warning lamps or text messages.
- Stop the vehicle safely as soon as possible.

⚠ CAUTION

Failure to heed the warning lamps and text messages when they appear may result in faults in the vehicle.

Cruise control operation

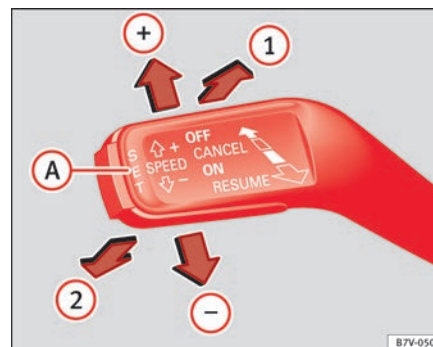

Fig. 151 On the left of the steering column: control lever for cruise control system.

Function	Control position, control operations ⇒ fig. 151	Action
Switching on the cruise control system.	Click ON ①	The system is switched on. The system does not maintain the speed because there is still no speed set.
Switching on the cruise control system.	SET button Ⓐ	The current speed is stored and maintained.
Temporarily switching off the cruise control system.	Press CANCEL ② or engage the clutch or the brake	The cruise control system is switched off temporarily. The speed setting will remain stored.

Function	Control position, control operations ⇒ fig. 151	Action
Switching the speed setting back on.	Press RESUME ①	The stored speed is reached again and maintained. If no speed has been set then the vehicle will record and maintain the actual speed of the vehicle.
Increasing the stored speed (during CCS setting).	Hold down SPEED + ⊕	<i>Short press:</i> Increases the speed at intervals of 10 km/h and records it. <i>Long press:</i> the vehicle accelerates while the button remains pressed. Release the button to store the current speed.
Reducing the stored speed (during CCS setting).	Press SPEED - ⊖	<i>Short press:</i> Reduces the speed at intervals of 10 km/h and records it. <i>Long press:</i> while this remains pressed, speed is reduced interrupting the accelerator <i>without</i> using the brakes. Release the button to store the current speed.
Switching off the cruise control system.	Click OFF ②	The system is switched off. The stored speed is deleted.

Travelling down hills with the CCS

When travelling down hills the CCS cannot maintain a constant speed. Slow the vehicle down using the brake pedal and reduce gears if required.

Automatic off

The cruise control system is switched off automatically or temporarily:

- If the system detects a fault that could affect the working order of the CCS.
- If you increase the stored speed by using the accelerator for a certain time.
- if the brake or clutch pedal is depressed.
- If you change gears.
- If the airbag is triggered.

Lane Assist system*

Introduction

Additional information and warnings:

- SEAT information system ⇒ page 62
- Accessories, parts replacement, repairs and modifications ⇒ page 257

WARNING

The intelligent technology in the lane assist system cannot change the limits imposed by the laws of physics and by the system itself. Careless or uncontrolled use of the lane assist system may cause accidents and injury. The system is not a replacement for driver awareness.

- Always adapt your speed and the distance to the vehicles ahead in line with visibility, weather conditions, the condition of the road and the traffic situation.
- Always keep your hands on the steering wheel so you can turn it at any time.
- The lane assist system does not detect all road markings. In some circumstances, the poor state of the road, structures located on it or certain objects may be mistakenly recognised as road markings by the lane assist system. In such situations, switch the lane assist system off immediately.
- Pay attention to the instructions on the instrument panel display and act accordingly to its requests.
- Always pay attention to the vehicle's surroundings.

Note

The lane assist system has been exclusively developed for driving on asphalted roads.



Note

If the lane assist system does not work as described in this chapter, do not use it and contact a specialist workshop.

Note

If you observe any system malfunction, have the system checked by a specialised workshop. ■

Control lamps

Blinks or lights up	Possible cause	Solution
 (yellow)	Lane assist system connected but inactive.	The system cannot clearly detect the lane. See and page 217, The lane assist system is inactive (control lamp lit in yellow).
 (green)	Lane assist system connected and active.	–

Several warning and control lamps should light up for a few seconds when the ignition is switched. This signals that the lamp is working properly. They will switch off after a few seconds.

WARNING

If the warning lamps and messages are ignored, the vehicle may stall in traffic, or may cause accidents and severe injuries.

- Never ignore the warning lamps or text messages.
- Stop the vehicle safely as soon as possible.

CAUTION

Failure to heed the warning lamps and text messages when they appear may result in faults in the vehicle.

Operation mode

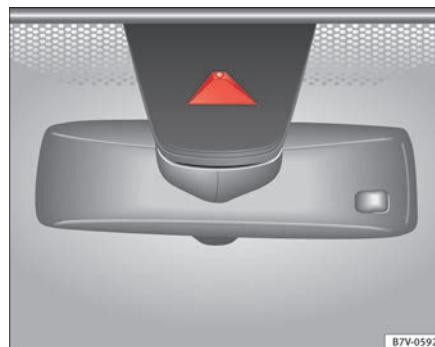

Fig. 152 In the sun visor: Field of vision of the lane assist system camera.

Using the camera located in the sun visor, the lane assist system detects the possible lines dividing the lanes. When the vehicle involuntarily approaches a dividing line it has detected, the system will notify the driver with a *corrective intervention*. It is possible to override the corrective intervention at any time.

If the turn signal is connected, there will be no warning as the lane assist system understands that you wish to change lanes voluntarily.

Steering wheel vibration

- The following situations cause the steering wheel to vibrate and require the driver to take active control of the steering:

- If the limits inherent to the system are reached.
- If the maximum rotational torque during the corrective intervention is not enough to keep the vehicle inside the lane.
- If during the corrective intervention by the system the lane is no longer detected.

Switching the lane assist system on or off

- Select the corresponding menu option using the button for the driver assist systems ⇒ page 62.
- **ALTERNATIVELY:** Activate or deactivate the system in the menu **Settings**, sub-menu **Assist systems**, menu **Lane Assist** ⇒ page 62. The “confirmation sign” indicates that the driver assist system is switched on.

Automatic deactivation: the lane assist system can be deactivated automatically if there is a system malfunction. Control lamp switches off.

The lane assist system is inactive (control lamp lit in yellow)

- When the speed of travel drops to below approx. 65 km/h (40 mph).
- When the lane assist system does not detect the dividing lines of the road. For example, in the event of road works, and snow, dirt, moisture or reflections.
- When the radius of a curve is too small.
- When there is no dividing line.
- When the distance to the next dividing line is excessive.
- When there are more than two lane markings per lane.
- When the TCS is disconnected.
- When the system does not detect any active rotation of the steering wheel by the driver during a prolonged period.
- Temporarily, in the event of very dynamic driving.
- When the turn signal is connected.



Note

Before starting travel, verify that the camera's field of vision is not covered ⇒ fig. 152.



Note

Keep the camera window clean.

Disconnect the lane assist system in the following situations

Due to the limits of the lane assist system, disconnect it in the following situations:

- When more attention is required of the driver
- For very sporty driving
- In very unfavourable weather conditions
- In very unfavourable road conditions
- In areas of road works

Sign Assist*

Introduction

Sign Assist can help the driver with information on speed limits or if overtaking is prohibited at that moment. The traffic signs and additional information detected by the system is represented in the instrument panel display and in the visual presentation of the navigation system map.

Applicable countries:

Sign Assist is supported in the following countries:

Andorra, Belgium, Denmark, Germany, Finland, France, Ireland, Italy, Liechtenstein, Luxembourg, Monaco, Netherlands, Norway, Austria, Poland, Portugal, San Marino, Sweden, Switzerland, Spain, Czech Republic, United Kingdom, Vatican City.

Additional information and warnings:

- SEAT information system ⇒ page 62
- Navigation system ⇒ Booklet Navigation system

WARNING

The traffic signs and instructions shown by Sign Assist may differ from the current traffic situation.

- The signs and Highway Code rules always take precedence over the instructions and display of Sign Assist.
- Adjust your speed and driving style to visibility, road, traffic and weather conditions.
- The system cannot always detect or correctly show all the traffic signs.

WARNING

The traffic sign detection is not a replacement for driver awareness.

- Adverse conditions of visibility, darkness, snow, rain and fog can cause the system not to show the traffic signs or to show them erroneously.

CAUTION

- If old mapping data is used in the navigation system, this may cause the traffic signs to be shown incorrectly.
- In the route points mode (navigation by route points) of the navigation system, Sign Assist is only partly available. ■

Indication on display

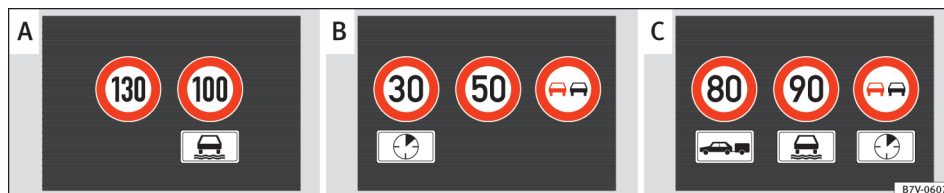

Fig. 153 Dash panel display: Examples of speed limits or overtaking prohibitions detected together with the corresponding additional signs.

Display text of Sign Assist on the instrument panel	Cause and solution
Error: Sign Assist	System fault. Have the system checked by a specialist workshop.
Sign Assist: Clean the windscreen!	The windscreen is dirty in the area of the camera. Clean the windscreen.
Sign Assist: only partly available at the moment.	No data is being transmitted from the navigator. Connect the navigator and insert the navigation data medium. ALTERNATIVELY: Sign Assist is not supported in the country in which you are driving at this time.

WARNING

If the warning lamps and messages are ignored, the vehicle may stall in traffic, or may cause accidents and severe injuries.

- Never ignore the warning lamps or text messages.
- Stop the vehicle safely as soon as possible.

CAUTION

Failure to heed the warning lamps and text messages when they appear may result in faults in the vehicle.

Operation mode

Sign Assist does not work in all countries. This must be taken into account when travelling abroad.

Display of traffic signs

Speed limits or overtaking prohibitions together with the corresponding additional signs are shown on the instrument panel display ⇒ fig. 153. Depending on the navigation system installed in the vehicle, traffic signs will be shown as above and also in the navigation system's map display.

When Sign Assist is connected, the vehicle records the traffic signs with a camera in the base of the interior rear vision mirror. After checking and evaluating the information from the camera, the navigation system and the current vehicle data, up to three valid traffic signs are displayed in conjunction with the corresponding additional signs. The traffic sign that is currently valid for the driver is shown first, in the left side of the screen. A traffic sign of only limited validity, eg. **90 km/h** is shown second, together with the additional sign "if the road is wet". If the vehicle's rain sensor detects rain

during travel, the traffic sign valid at this moment will move to the first position along the additional sign “if the road is wet”.

The permanent display on the instrument panel screen is shown as you pass the real traffic signs. The signs for entering and leaving towns activate the display of the usual speed limits for that country on roads in populated areas and national highways, even if the speed is not limited by an actual traffic sign.

The end of a prohibition or limitation is not displayed. If you exceed the speed limits shown, a warning will not appear. The system does not detect areas with little traffic. The current legal provisions apply.

Connection and disconnection

- Connect or disconnect the assist system in the **Settings** menu in the SEAT information system ⇒ page 62.
- **ALTERNATIVELY:** Press the button for the driver assist systems on the main beam lever.

Trailer

Connect or disconnect the secondary display for speed limits and overtaking bans that apply to trailers (trailer mode) in the **Settings** menu in the SEAT information system ⇒ page 62. ■

Tyre monitoring systems

Introduction

The tyre monitor indicator monitors the tyre pressure of each wheel during driving using the ABS sensors. The ABS sensors monitor the tyre tread perimeter and vibrations of each tyre. The tyre monitor indicator warns the driver if it detects a considerable drop in tyre pressure of one or several tyres while driving. Loss of tyre pressure will be indicated by the indicator (⚠) as well as a sound and sometimes a text message on the screen of the instrument panel. When you open the driver's door, you will find a label indicating the tyre pressure recommended by the manufacturer for the maximum vehicle load for each tyre approved for the vehicle in question. By pressing the adjustment button on the tyre monitoring indicator, you may change the reference pressure for the tyres so that the tyre pressure to be monitored coincides with actual tyre pressure ⇒ page 223.

Suitable use of the adjustment button ⇒ page 223.

Additional information and warnings:

- Transporting ⇒ page 13
- Braking, stopping and parking ⇒ page 183
- Caring for and cleaning the vehicle exterior ⇒ page 242
- Wheels and tyres ⇒ page 293
- Accessories, parts replacement, repairs and modifications ⇒ page 257



WARNING

Unsuitable handling of the wheels and tyres may lead to sudden tyre pressure losses, to tread separation or even to a blow-out.

- Check tyre pressures regularly and ensure they are maintained at the pressures indicated. If the tyre pressure is too low, the tyres could over-heat, resulting in tread detachment or even burst tyres.
- Tyre pressure should be that indicated on the label when the tyres are cold at all times ⇒ page 297.
- Regularly check the cold inflation pressure of the tyres. If necessary, change the tyre pressure of the vehicle tyres while they are cold.
- Regularly check your tyres for damage and wear.
- Never exceed the maximum permitted speed or loads specified for the type of tyre fitted on your vehicle.



WARNING

Incorrect use of the tyre monitoring indicator button could result in the indicator giving erroneous messages or prevented from indicating the danger caused by a defective tyre ⇒ page 223.



CAUTION

- The tyre valves may be damaged if the cap is not in place. Check that the caps are identical to the standard caps and have been correctly tightened. Do not use metal caps ⇒ page 223.
- Do not damage the valves when changing the tyres ⇒ page 223.



For the sake of the environment

Under-inflated tyres lead to increased fuel consumption and tyre wear. ▶

**Note**

- Do not only rely on the tyre monitoring system. Regularly check your tyres to ensure that the tyre pressure is correct and that the tyres are not damaged due to puncture, cuts, tears and impacts/dents. Remove objects from the tyres only when the tyres have not been pierced by these.
- The tyre monitoring system is set to the tyre pressure recommended by the manufacturer and indicated on the label ⇒ fig. 176. ■

Elements of the tyre monitoring indicator

Tyre monitoring indicator with button.

See ⇒ page 223.

▶ Warning lamp (⚠) on the instrument panel.

▶ (⚠ SET) button on the centre console.

▶ Monitoring the tread of all tyres using ABS sensors (indirect measurement).

▶ Adjustable medium and full-load tyre pressures.

▶ Button to update the system when the tyre pressure is changed. ■

Control lamp

Lights up or flashes	Possible cause ⇒ ⚠	Solution
	The tyre pressure of a wheel has dropped considerably in relation to the pressure set by the driver ⇒ page 223.	Stop the vehicle! Reduce your speed immediately! Stop the vehicle safely as soon as possible. Avoid sudden manoeuvres and braking! Check all tyres and pressures. Replace any damaged tyres.
	System malfunction.	Consult a specialist workshop if the tyre pressure is correct and the lamp remains lit after switching the ignition off and back on again. Have the system checked there.

Several warning and control lamps should light up for a few seconds when the ignition is switched. This signals that the lamp is working properly. They will switch off after a few seconds.

**WARNING**

When the tyres are inflated at different pressures or at a pressure that is too low then a tyre may be damaged resulting in a loss of control of the vehicle and a serious or mortal accident.

- If the indicator (⚠) lights, stop immediately and check the tyres.
- If the tyres are inflated at different pressures or if a tyre pressure is too low, this will increase tyre wear, negatively affecting vehicle stability and increasing braking distances. ▶

⚠ WARNING (Continued)

- If tyres are inflated at different pressures or a tyre pressure is too low, a tyre may be damaged and burst resulting in a loss of control of the vehicle.
- The driver is responsible for ensuring that all of the vehicle tyres are correctly inflated to the right pressure. The recommended tyre pressure is indicated on the label ⇒ fig. 176.
- The tyre monitoring system can only operate correctly if all of the tyres are inflated to the correct pressure when cold.
- Driving with tyres at the wrong pressure can cause damage to them and result in an accident. Ensure that the tyre pressures of all the tyres correspond to the vehicle load.
- Before starting a journey, always inflated tyres to the correct pressure.
- If tyre pressure is too low then the tyre is subject to greater forces and it may be heated to such an extent that the tread can rupture and the tyre will burst.
- With an overloaded vehicle at high speed, the tyres can overheat and burst resulting in a loss of vehicle control.
- Tyre pressures which are too high or too low reduce the useful life of the tyre, affecting the vehicle's performance.
- If a tyre has not been punctured then it does not have to be changed immediately; drive to the nearest specialist workshop at a moderate speed and have the tyre checked and inflated to the correct pressure.

⚠ WARNING

If the warning lamps and messages are ignored, the vehicle may stall in traffic, or may cause accidents and severe injuries.

- Never ignore the warning lamps or text messages.
- Stop the vehicle safely as soon as possible.

⚠ CAUTION

Failure to heed the warning lamps and text messages when they appear may result in faults in the vehicle.

Tyre monitoring indicator

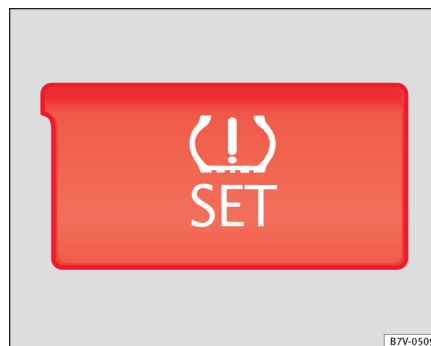

Fig. 154 Detailed view of the centre console: button for the tyre pressure monitoring indicator.

The tyre monitor indicator compares wheel revolutions and, with this information, the tread of each wheel using the ABS sensors. If the tread of a wheel is changed, the tyre monitoring indicator will indicate as such on the instrument panel. The wheel tread changes when:

- Tyre pressure is insufficient.
- Tyre structure is damaged.
- The vehicle is unbalanced because of a load.
- The wheels on an axle are subject to a heavier load (e.g. when towing a trailer).

- The vehicle is fitted with snow chains.
- The wheel on one axle is changed.

There may be a delay in the reaction of the tyre monitoring indicator (Ⓛ) or it may not indicate anything under certain circumstances (e.g. sports driving, snow-covered or unpaved roads).

Adaptation of the tyre monitoring indicator

On adjusting tyre pressure or changing one or more wheels, the ⇒ [fig. 154](#) button on the tyre monitoring indicator must be kept pressed down, with the ignition on, until a signal is heard. Do the same, for example, when the front and rear wheels are swapped ⇒ [fig. 175](#).

If the wheels are subjected to an excessive load (towing a trailer, heavy load), the tyre pressure must be increased to the maximum recommended pressure ⇒ [page 293](#). Press the tyre monitoring indicator button to confirm the new pressure value.



Note

An erroneous indication may be given when snow chains are in use because the chains increase the tread of the wheel. ■

Practical tips

Driving and the environment

Running-in

Please observe the instructions for running-in new components.

Running-in the engine

The engine needs to be run-in over the first 1500 km (1000 miles). During its first few hours of running, the internal friction in the engine is greater than later on when all the moving parts have bedded down.

How the vehicle is driven for the first 1500 km (1000 miles) influences the future engine performance. Throughout the life of the vehicle, it should be driven at a moderate speed – especially when the engine is cold – this will reduce engine wear and increase its useful life. Never drive at extremely low engine speeds. Always engage a lower gear when the engine works “irregularly”. **For the first 1000 km or 600 miles, please note:**

- Do not use full throttle.
- Do not force the engine above two thirds of its maximum speed.
- Do not tow a trailer.

Between 1000 and 1500 kilometres (600 to 1000 miles), gradually increase power until reaching the maximum speed and high engine speeds.

Running in new tyres and brake pads

- Replacement of new tyres and wheel rims ⇒ page 293
- Notes on the brakes ⇒ page 187



For the sake of the environment

If the engine is run in gently, the life of the engine will be increased and the engine oil consumption reduced. ■

Ecological driving

Introduction

Fuel consumption, environmental impact and engine, brake and tyre wear depend largely on three factors:

- Personal driving style.
- Conditions of use (weather, road surface).
- Technical requirements.

Savings of up to 25% in fuel consumption are possible with an appropriate driving style and the adoption of certain simple tips.



WARNING

Always adapt your speed and the distance to the vehicles ahead in line with visibility, weather conditions, the condition of the road and the traffic situation. ■

Economic driving style

Changing gear early

General instructions: The highest gear is always the most economical gear. As a guideline, for the majority of vehicles: At a speed of 30 km/h, drive in third gear, at 40 km/h in fourth gear and at 50 km/h in fifth gear.

In addition, skipping gears when shifting up helps to save fuel, weather and traffic conditions permitting.

Do not wait until the last moment before changing gear. Only use first gear when you move off and change to second gear quickly. Avoid the kick-down function in vehicles with automatic gearbox.

Vehicles with a gear display help to achieve an economical driving style as the display indicates the best moment to change gear.

Let the vehicle roll

If you take your foot off the accelerator, the fuel supply is stopped and consumption is reduced.

Allow the vehicle to roll without accelerating, for example when approaching a red traffic light. However, if the vehicle is rolling too slowly or the distance is too long, the clutch pedal should be pressed to declutch. The engine will then operate at idle speed.

If the vehicle is going to be at a standstill for a period of time, switch off the engine; for example, while waiting at a level crossing. In vehicles which have the Start-Stop function on, the engine switches off automatically when the vehicle is not moving.

Think ahead and “flow” with the traffic

Frequent acceleration and braking considerably increase fuel consumption. If you think ahead as you drive and keep a safe distance from the vehicle in front, it is possible to slow down by simply lifting your foot off the accelerator. This eliminates the need for constant braking and acceleration.

Calm and steady driving

Constancy is more important than speed: The more you drive at a constant speed, the lower the fuel consumption.

When driving on the motorway, it is more efficient to drive at a constant and more moderate speed than to be continuously accelerating and braking. As a general rule, you will reach your destination just as quickly when you drive at a constant speed.

The cruise control function helps you to achieve a constant style of driving.

Moderate use of additional electrical appliances

It is important to travel in comfort, but convenience systems should be used in an ecological manner.

Some equipment, when connected, increase fuel consumption considerably, for example:

- Air conditioning cooling system: If the air conditioning system is required to cool to significantly lower temperatures than the true outside temperature, it will require a large quantity of energy from the engine. Therefore, we recommend that the selected temperature for the vehicle is not too different to the outside temperature. It is a good idea to open all the windows of the car before starting your journey, and to drive a short distance with all the windows open to allow the vehicle to cool down slightly. Only then should you close all the windows and switch on the air conditioning. Keep windows closed when travelling at high speeds. Driving with the windows open increases fuel consumption.
- Switch off the seat heating when the seats have warmed up.
- Switch off the heated rear window and the windscreen heating when the windows have demisted and are free of ice.
- Do not leave the auxiliary heater switched on when the vehicle is moving → page 163.

Other factors which increase fuel consumption (examples):

- Fault in engine management.
- Driving on hills.
- Trailer towing.

Saving fuel while driving

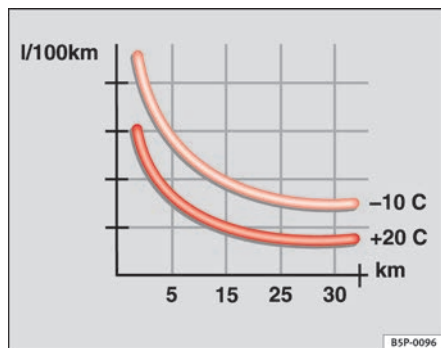

Fig. 155 Fuel consumption in litres per 100 km at different outside temperatures.

By adopting an economical driving style and anticipating the traffic situation ahead, you can easily reduce fuel consumption by 10-15%.

A vehicle uses most fuel when accelerating. By anticipating the traffic situation ahead, you will brake and therefore accelerate less. Wherever possible, let the car roll slowly to a stop, for instance when you can see that the next traffic lights are red.

Avoid short journeys

Fuel consumption is much higher when the engine is cold, immediately after it has been started. It takes a few kilometres of driving for the engine to warm up and to normalise consumption.

The engine and catalytic converter need to reach their proper **working temperature** in order to minimise fuel consumption and emissions. The **ambient temperature** has a decisive influence.

- fig. 155 shows the difference in consumption for the same journey at +20 °C (+68 °F) and at -10 °C (+14 °F).

Unnecessary short journeys should be avoided. Try to combine trips.

The vehicle uses more fuel in winter than in summer, even when other conditions are the same.

“Warming” the engine is not only forbidden in some countries, but in practice it is technically superfluous as it is a waste of fuel.

Adjusting tyre pressures.

Having the correct pressure in your tyres helps to reduce rolling resistance and, as a result reduces fuel consumption. Increasing the tyre pressure slightly (+ 0.2 bar / + 3 psi) can help to save fuel.

If you are prepared to accept a slight reduction in comfort, the tyres may be filled to the pressures recommended for a fully-loaded vehicle. This is also valid when driving alone without luggage.

When you buy new tyres, make sure they are optimised for minimum rolling resistance.

Use low friction engine oil

The use of low viscosity totally synthetic oils, known as low friction engine oil, help to reduce fuel consumption. Low friction engine oils reduce the resistance caused by friction in the engine, they flow around the engine more quickly and efficiently, particularly in cold starts. The effect is particularly noticeable in vehicles frequently used for short journeys.

Always check the engine oil level and observe service intervals (engine oil change intervals).

When purchasing engine oil, always observe legal requirements and ensure that the oil is approved by SEAT. ▶

Avoid carrying unnecessary loads

The lighter the vehicle, the more economical and ecological the driving style. For example, an additional weight of 100 kg will increase fuel consumption up to 0.3 l/100 km.

Remove any unnecessary objects or loads from the vehicle.

Remove optional equipment and unnecessary accessories

The more aerodynamic the vehicle, the lower the fuel consumption. Optional equipment and accessories (such as roof racks or bike carriers) reduce the aerodynamic benefits of the vehicle.

Therefore, we recommend you remove all optional and unnecessary equipment and racks, especially if you intend to drive at high speeds.

Engine management and exhaust gas purification system

Introduction

Additional information and warnings:

- Changing gear ⇒ page 174
- Refuelling ⇒ page 264
- Fuel ⇒ page 267
- Engine oil ⇒ page 279
- Vehicle battery ⇒ page 288
- Information stored in the control units ⇒ page 257
- Tow-starting and towing away ⇒ page 340









WARNING

The components of the exhaust system reach very high temperatures. This could cause a fire.

- Always park your vehicle so that no part of the exhaust system can come in contact with flammable materials (such as dried grass).
- Do not apply additional underseal or anti-corrosion coatings to the exhaust pipes, catalytic converter, heat shields or the diesel particulate filter.

Warning lamps

lights up	Possible cause	Solution
	Fault in engine management (Electronic Power Control).	Take the vehicle to a Technical Service as soon as possible and have the engine checked.
	Pre-heating a diesel engine before starting the engine.	⇒ page 170
	Fault in catalytic converter.	You should reduce speed accordingly. Drive carefully until you reach the next qualified workshop. Have the engine checked there.
	Diesel particulate filter blocked	Drive for 15 minutes in 4th gear (manual gearbox), or in D (automatic gearbox) at a minimum speed of 70 km/h (45 mph). Observe speed limits ⇒  . If the warning lamp remains lit up, take the vehicle to a Technical Service ⇒ page 229.

flashes	Possible cause	Solution
	Fault in the engine management (diesel engines).	Take the vehicle to a Technical Service as soon as possible and have the engine checked.
	Combustion fault which could damage the catalytic converter.	You should reduce speed accordingly. Drive carefully until you reach the next qualified workshop. Have the engine checked there.

Several warning and control lamps should light up for a few seconds when the ignition is switched. This signals that the lamp is working properly. They will switch off after a few seconds.



WARNING

Observe traffic regulations when cleaning the diesel particulate filter while driving.

- Only carry on driving if visibility, weather, road and traffic conditions so permit.
- Never endanger your safety or that of other road users.





CAUTION

Always pay attention to any lit lamps and to the corresponding descriptions and instructions to avoid damage to the vehicle.



Note

While the indicators ,  or **EPC** remain lit, there may be engine problems, fuel consumption may be greater and the engine may lose power. ■

Catalytic converter

The catalytic converter permits the subsequent treatment of the exhaust gases thus reducing contaminating gas emissions. To ensure a longer working life for the exhaust system and catalytic converter in a petrol engine:

- Always use unleaded petrol.
- Never run the tank completely dry.
- Do not top up with too much engine oil ⇒ page 279.
- Do not tow-start the vehicle; use the starter cables ⇒ page 337.

If you should notice misfiring, uneven running or loss of power when the car is moving, reduce speed immediately. Have the car inspected by a Technical Service. If this happens, unburnt fuel can enter the exhaust system and escape into the atmosphere. The catalytic converter can also be damaged by overheating.



For the sake of the environment

Even when the emission control system is working perfectly, there may be a smell of sulphur from the exhaust gas under some conditions. This depends on the sulphur content of the fuel being used. ■

Diesel particulate filter

The diesel particulate filter removes soot particulates from the exhaust gas. The filter retains these particulates and burns them. To assist the combustion process, SEAT recommends you avoid frequent short trips.

- Always use diesel with a low sulphur content ⇒ page 267.
- Never use petrol or fuel oil.
- Never use biodiesel. However, a blend prepared by the diesel manufacturer containing biodiesel within the limits established by the EN 590 standard may be used ⇒ page 267. ►

- Never run the tank completely dry.
- Do not top up with too much engine oil ⇒ page 279.
- Do not tow-start the vehicle; use the starter cables ⇒ page 337.

In order to reduce blocking of the diesel particulate filter, some vehicles with an automatic gearbox may increase the engine speed slightly to automatically start cleaning the diesel particulate filter. The warning lamp will not light up in this case .



For the sake of the environment

Even when the emission control system is working perfectly, there may be a smell of sulphur from the exhaust gas under some conditions. This depends on the sulphur content of the fuel being used. ■

Trailer towing

Introduction

Always be aware of the legal requirements for each country to drive with a trailer and to use a trailer bracket.

Your car is intended mainly for transporting passengers however, it can also be used to tow a trailer provided that it is fitted with the necessary equipment. The additional load has an effect on the useful life, fuel consumption and the vehicle performance and, in some cases, reduce the service intervals.

Driving with a trailer requires more force from the vehicle and, thus, more concentration from the driver.

For wintertime temperatures, fit winter tyres to the vehicle **and** the trailer.

Drawbar load

The *maximum* permitted Drawbar load exerted by the trailer drawbar on the ball joint of the tow hitch must not exceed **100 kg (approximately 220 lbs)**.

Vehicles with the Start-Stop function

With a SEAT factory fitted or retrofitted trailer bracket, the Start-Stop function is automatically deactivated when a trailer is connected. For trailer brackets **not** installed by SEAT, the Start-Stop function must be deactivated manually using a button located on the dashboard **before** driving with a trailer and it must remain off for the entire journey ⇒ .

Additional information and warnings:

- Anti-theft alarm system ⇒ page 74
- Light ⇒ page 95
- Ecological driving ⇒ page 225
- Starter assist systems (Start-Stop function) ⇒ page 194

- Wheels and tyres ⇒ page 293
- Accessories, parts replacement, repairs and modifications ⇒ page 257



WARNING

Never transport people in a trailer: this will endanger in their life and is against the law.



WARNING

The incorrect use of the tow hitch can cause accidents and injury.

- **Only use a tow hitch in good condition and correctly installed.**
- **Never change or repair a tow hitch.**
- **To reduce the risk of injury in case of a reversing collision, injury to pedestrians and cyclists when parking, always keep the ball joint in when a trailer is not being used.**
- **Never fit a trailer tow hitch “that distributes the load” or “balances the load”. Your vehicle has not been designed for this type of tow hitch. The tow hitch may fail and the trailer will separate from the vehicle.**



WARNING

Driving with a trailer and transporting heavy or large objects can affect vehicle handling and even cause an accident.

- **Always secure loads correctly with suitable and undamaged attachment rope or straps.**
- **Adjust your speed and driving style to visibility, road, traffic and weather conditions.**

 **WARNING (Continued)**

- Trailers with a high centre of gravity can overturn more easily than trailers with a low centre of gravity.
- Avoid brusque manoeuvres and sudden braking.
- Always take the following precautions seriously.
- Reduce your speed immediately if you observe the trailer rocking from side to side.
- Never drive at more than 80 km an hour when towing a trailer (or 100 km an hour in exceptional circumstances). This also applies in countries where higher speeds are permitted. Always take the speed limits for vehicles with and without trailers in each country into account.
- Never try to stop the “snaking” by increasing speed.

 **WARNING**

When driving with a trailer and using a trailer hitch that was not installed by SEAT, the Start-Stop function must be manually deactivated. Otherwise, this could cause a braking anomaly that could result in an accident with serious consequences.

- Always manually deactivate the Start-Stop function when a trailer is being used on a trailer hitch that has not been installed by SEAT.

**Note**

- Always turn off the anti-theft alarm system before connecting or disconnecting a trailer ⇒ page 78. Otherwise, the tilt sensor may erroneously activate the alarm.
- Never use a trailer with a new engine (for the first 1000 km or 600 miles) ⇒ page 257.

- At SEAT, we recommend folding in the trailer hitch ball when a trailer is not being used. In case of a rear collision, the damage caused to the vehicle with the extended trailer hitch ball could be more extensive.
- In some models, a trailer hitch is necessary for towing vehicles. For this reason, you should store the tow hitch in the vehicle at all times. ■

Driving with a trailer

Technical requirements

If the car is supplied with a **factory-fitted** tow hitch it will already have the necessary technical modifications and meet the statutory requirements for towing a trailer.

Only use an approved trailer hitch for the gross trailer weight rating. The tow hitch must be suitable for both the vehicle and trailer and must be securely fitted to the vehicle chassis. Only use a tow hitch with a removable ball joint. Always check and take into account the tow hitch manufacturer's instructions. Never fit a trailer tow hitch "that distributes the load" or "balances the load".

Bumper mounted tow hitch

Never fit a tow hitch or its attachments to the bumper. A tow hitch should never interfere with the bumper performance. Do not modify the exhaust system and brake system. Regularly check the tow hitch to ensure it is firmly fitted.

Engine cooling system

Driving with a trailer increases the load on the engine and cooling system. The cooling system should always have sufficient coolant and to be able to cope with the vehicle and trailer.

Electric trailer brake

If the trailer has its own braking system, please note the relevant legal requirements. The trailer braking system should never be connected to the vehicle braking system.

Trailer cable

Always use a cable between the vehicle and the trailer ⇒ page 235.

Trailer rear lights

The rear lights of a trailer must fulfil the corresponding standards ⇒ page 235.

Never connect the trailer's rear lights directly to the vehicle electric system. In case of any doubt about the electrical connection of the trailer, ask a specialist workshop. SEAT recommends visiting a Technical Service.

Wing mirrors

When the field of vision behind the trailer cannot be seen using the standard wing mirrors of the towing vehicle, additional wing mirrors are required according to the legal requirements of each country. The wing mirrors must be fitted before driving and must provide a sufficient field of vision behind.

Trailer electricity consumption

Never exceed the specifications:

Electrical consumer	Maximum power
Position lights and rear lights	50 Watts
Indicator (each side)	54 Watts
Brake lights (total)	84 Watts
Reversing lights (total)	42 Watts
Rear fog light	42 Watts



WARNING

If the tow hitch is badly fitted or unsuitable, the trailer may separate from the vehicle causing an accident with serious consequences.

! CAUTION

- If the rear lights of the trailer are not correctly connected, the vehicle electronics may be damaged.
- If the trailer absorbs excessive electric current, the vehicle electronics may be damaged.
- Never connect the trailer's electric system to the electrical connections of the rear lights or any other power sources. Only use suitable connections for providing electric current to the trailer.

i Note

- Towing a trailer places additional demands on the vehicle. At SEAT, we recommend additional services between the normal inspection intervals if the vehicle is used frequently for towing a trailer.
- In some countries, an additional fire extinguisher is required if the trailer weight is more than 2500 kg

Electric tow hitch ball*

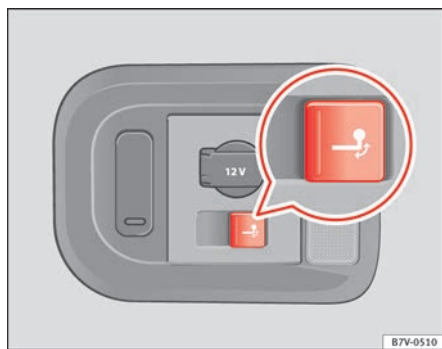

Fig. 156 Right-hand side of the luggage compartment: button to electrically release the tow hitch ball.

The rotation radius of the tow hitch ball should be free of people, animals and objects ⇒ ⚠.

The tow hitch is located in the bumper. The electric tow ball is fixed and cannot be removed.

Releasing and unfolding the tow ball

- Stop the vehicle and apply the electric parking brake.
- Switch the engine off.
- Open the tailgate.
- Press the knob briefly ⇒ fig. 156. The tow ball is released electronically and folds out automatically; the button indicator will blink.
- Move the ball joint until it inserts and the button indicator lights.
- Close the tailgate.
- Before hitching the trailer, remove the dust guard from the ball.
- The indicator only lights when the tailgate is open and when a trailer is not hitched.

Restoring the tow ball to its originally position

- Stop the vehicle and apply the electric parking brake.
- Switch the engine off.
- Remove the trailer and disconnect the cable between the vehicle and trailer. If necessary, remove the socket adapter.
- Place the dust guard over the ball.
- Open the tailgate.
- Press the knob briefly ⇒ fig. 156. The tow ball is electronically released; the indicator blinks.
- Push the tow ball into the bumper until it locks in position and the button indicator lights.
- Close the tailgate.

The warning lamp

- When the indicator *flashes*, the tow ball is not in its final position, has not engaged or is damaged ⇒ .
- When the indicator *remains lit* and the tailgate is open, the tow ball has inserted correctly into the folded or deployed position.
- When the tailgate is closed, the indicator is turned off.

WARNING

The incorrect use of the tow hitch can cause accidents and injury.

- Ensure that no person, animal or object gets in the way of the tow ball.
- Never push the button when there is a trailer hitched or when any kind of carrier or accessory is fitted to the tow hitch ball.
- While the ball is moving, do not interfere with any tool.
- Do not drive with a trailer if the indicator does not light.
- If there is a fault in the electric system or the trailer tow hitch, visit a specialist workshop to have it checked.
- If the diameter of the tow hitch is less than 49 mm, never use this for a trailer.

CAUTION

- If anything is attached to the tow hitch ball, do not, under any circumstances press the button.
- Never direct a high-pressure or steam cleaning system directly at the tow hitch ball or trailer power socket. This could cause damage to seals or remove lubricating grease.

Note

In extremely low temperatures, it is possible that the tow hitch is not released. In this case, place the vehicle in a warmer location (for example, a garage).

Installing a bicycle carrier to the tow hitch

The maximum load permitted for a bicycle carrier on the tow hitch ball is **75 kg**, with a maximum distance of 300 mm from the support. The distance between supports is the distance between the bicycle carrier centre of gravity (with the bicycles) and the centre of point of the tow hitch ball.

WARNING

The incorrect use of the tow hitch with a bicycle carrier installed can cause accidents and injury.

- Never exceed the load and distances between supports indicated.
- Never fit the bicycle carrier to the tow hitch ball neck, underneath the tow hitch given that the bicycle carrier may be incorrectly fitted due to the shape of the tow hitch and the model of bicycle carrier.
- Always read and take the manufacturer assembly instructions into account.

CAUTION

Exceeding the maximum load and distance between supports indicated can cause considerable damage to the vehicle.

- Never exceed the specifications. ■

Hitching and connecting the trailer

Trailer cable

Always secure the trailer cable to the towing vehicle correctly. Leave a little bit of slack in the cable for turning. However, ensure that the cable does not rub off the ground while driving. ▶

Trailer electric socket

The electric connection between vehicle and trailer is a 13-pin socket. If the trailer plug has **seven pins**, an adapter cable must be used.

Trailer rear lights

Check the trailer rear lights to ensure they work correctly and remain legal. Ensure that the trailer does not use more than the maximum power
⇒ page 233.

Trailer connected to the antitheft alarm:

- When a vehicle comes from the factory fitted with an antitheft alarm and tow hitch.
- When the trailer is connected to the vehicle using the socket.
- When the vehicle and trailer electrical systems work correctly and are not damaged.
- When the vehicle is locked using the vehicle key and the antitheft alarm is turned on.

When the vehicle is locked, the alarm is triggered when the electrical connection between the vehicle and the trailer is removed.

Always turn off the anti-theft alarm system before connecting or disconnecting a trailer. Otherwise, the tilt sensor may erroneously activate the alarm.

WARNING

Erroroneous or unsuitable connection of electric cables may supply energy to the trailer causing an anomaly in the vehicle electronics that could result in an accident with serious consequences.

- **All work on the electrical system must be carried out only by a specialist workshop.**
- **Never connect the trailer's electric system to the electrical connections of the rear lights or any other power sources.**

CAUTION

Do not leave the trailer connected to the vehicle when parked; places on its support wheel or its supports. For example, when changing the load or a puncture, the vehicle will be pushed up or down. The force acting on the tow hitch and the trailer could damage the vehicle or the trailer.

Note

- In case of a fault in the vehicle or trailer electrical system or in case of problems with the antitheft alarm system, have the system checked by a specialist workshop.
- If the trailer accessories use energy from the socket when the engine is stopped, the battery will be discharged.
- For technical reasons, trailers fitted with rear LED lights cannot be connected to the antitheft alarm system.
- If the vehicle battery is running low, the electrical connection with the trailer is automatically cut.
- With the engine running, the electrical equipment on the trailer will consume power. ■

Loading the trailer

Trailer weight / drawbar load

The trailer weight is the load that the vehicle can pull ⇒ . The drawbar load is the vertical weight of the trailer hitch on the tow hitch ball
⇒ page 240.

The figures for trailer weights and draw bar weights given on the data plate of the towing bracket are for values of this model only. The correct figures for your specific vehicle, which may be *lower* than these figures for the tow hitch, are given in the registration documents. The instructions in the official vehicle documents take precedence. ►

For the sake of road safety, SEAT recommends using the maximum allowed **drawbar load**. The handling of the combined vehicle and trailer will be poor if the drawbar load is too low.

The drawbar load increases the weight on the rear axle, reducing the vehicle carrying capacity.

Gross combination weight

This figure refers to the combined weight of the loaded vehicle and loaded trailer.

Loading the trailer

The combined vehicle and trailer must be balanced. Use the maximum drawbar load authorised and do not overload the front or the rear of the trailer:

- Distribute loads in the trailer so that heavy objects are as near to the axle as possible or even above it.
- Correctly secure the trailer load.

Tyre pressure

Inflate the trailer tyres according to the manufacturer's instructions.

Inflate the towing vehicles tyres to the maximum ⇒ page 293.

WARNING

Exceeding the maximum authorised axle load, drawbar load or the gross combination weight of the towing vehicle and trailer could cause a serious accident with severe consequences.

- **Never exceed the specifications.**
- **With the actual load on the front and rear axles, the maximum axle load should never be exceeded. The weight on the front and rear should never exceed the gross vehicle weight.**

WARNING

If the load moves, the stability and safety of the vehicle and trailer combination will be seriously affected and this could result in a serious accident.

- **Always correctly load the trailer.**
- **Always secure loads correctly with suitable and undamaged attachment rope or straps.**

Driving with a trailer

Adjusting the headlights

When towing a trailer, the front of the vehicle may rise and so the dipped beam headlights may blind other drivers. Use the headlight range control to lower the cone of light. If you do not have headlight range control, have the headlights adjusted by a qualified dealership. Vehicles with high-intensity discharge lamps adapt automatically and do not require adjustment.

Details of driving with a trailer



- If the trailer has an **overrun brake**, apply the brakes *gently at first* and then, firmly. This will prevent the jerking that can be caused by the trailer wheels locking.
- As of the combined vehicle and trailer mass, braking distances will be greater.
- Select a low gear before driving down a steep hill to use the engine braking effect to slow down the vehicle. Otherwise, the braking system could overheat and fail.

- The vehicle centre of gravity and handling change because of the trailer load and because of the increased combined mass of the vehicle and trailer.
- If the towing vehicle is empty and the trailer loaded then the load distribution is incorrect. If you must travel in these conditions, drive carefully and reduce your speed accordingly.

Hill starts with a trailer

Depending on the hill and the gross combined weight, it is possible that the combined vehicle and trailer move backwards slightly when starting.

For a hill start with a trailer, proceed as follows:

- Press and hold the brake pedal.
- Press the button  once to turn off the electric parking brake ⇒ page 183.
- Press and hold the button  to hold the vehicle and trailer combination using the parking brake.
- With a manual gearbox: press the clutch pedal to the floor.
- Engage first gear or the gear range **D** ⇒ page 174, Changing gear.
- Release the brake pedal.
- Move off slowly. To do this, gently release the clutch pedal (for manual gearbox).
- Release the button  only when the engine provides sufficient power to move the vehicle and trailer combination.



WARNING

Jerking the trailer in an unsuitable manner could cause loss of vehicle control with the subsequent serious consequences.

- **Driving with a trailer and transporting heavy or a large objects will change the vehicle handling and braking distances.**



WARNING (Continued)

- **Anticipate traffic and be extremely cautious. Brake early.**
- **Adjust your speed and driving style to visibility, road, traffic and weather conditions. Reduce your speed, especially on steep hills.**
- **Accelerate gently and carefully. Avoid brusque manoeuvres and sudden braking.**
- **Always take the following precautions seriously. Reduce your speed immediately if you observe the trailer rocking from side to side.**
- **Never try to stop the “snaking” by increasing speed.**
- **Always take the speed limits for vehicles with and without trailers in each country into account.**

Stabilising the vehicle and trailer combination

Stabilisation of the vehicle and trailer combination is an extension of the electronic stability control ESC (ESP) and helps, with the assistance of the trajectory control, to reduce trailer “snaking”.

Stabilisation of the vehicle and trailer combination is active when the ESC (ESP)  indicator on the dashboard remains lit for about two seconds more than the ABS indicator.

Requirements for stabilising the vehicle/trailer combination

- An original tow hitch is fitted by the manufacturer or a compatible model is retrofitted.
- The ESC (ESP) is on. The warning indicator in the control panel  is not lit.
- The trailer is connected to the vehicle using the socket.
- The vehicle is driven faster than 60 km/h.
- The maximum drawbar load is used.

- The trailer must have a fixed drawbar.
- Trailers with brakes must be equipped with a mechanical inertia brake.

WARNING

Do not let the extra safety afforded by the stabilisation system tempt you into taking any risks when driving.

- Adjust your speed and driving style to visibility, road, traffic and weather conditions.
- If the road surface is slippery, take care when accelerating.
- When a system is operating, lift your foot off the accelerator.

WARNING

It is possible that the combination stabilisation system does not correctly recognise all driving situations.

- It is possible that the stabilisation system does not detect snaking of a light trailer and thus does not intervene.
- When driving on slippery ground, the trailer could *jack-knife* despite the stabilisation system.
- Trailers with a high centre of gravity may even tip over before they start to rock sideways.
- If a trailer is not used at the trailer socket is connected (for example, installation of a bicycle carrier with lights), repeated automatic braking may occur in extreme driving conditions.

Retrofitting a tow hitch

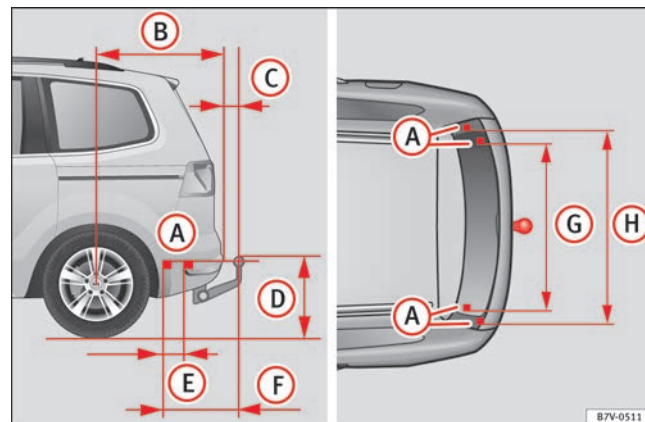

Fig. 157 Measurements and attachments to retrofit a tow hitch.

SEAT recommends visiting a specialist workshop to retrofit a tow hitch. For example, it may be necessary to adjust the cooling system or to include thermal plates. SEAT recommends visiting a Technical Service.

In any case, the separation distances must be observed when fitting a tow hitch. The distance between the centre of the tow hitch ball and the road surface \Rightarrow fig. 157 D must never be lower than that indicated. This also applies when the vehicle is fully laden, including maximum drawbar load.

Separation distances \Rightarrow fig. 157:

- A** Attachment points.
- B** 1040 mm (41 inches)
- C** 74 mm (3 inches)
- D** 364 mm (14 inches)

- E** 247 mm (10 inches)
- F** 596 mm (23 inches)
- G** 1097 mm (43 inches)
- H** 1102 mm (43 inches)

WARNING

Erroneous or unsuitable connection of electric cables may cause anomalies in the vehicle electronics that could result in an accident with serious consequences.

- **Never connect the trailer's electric system to the electrical connections of the rear lights or any other unsuitable power sources. Only use suitable connectors to connect a trailer.**
- **Visit a specialist workshop if you wish to retrofit a tow hitch to the vehicle.**

WARNING

If the tow hitch is badly fitted or unsuitable, the trailer may separate from the vehicle while driving. This could result in serious accident.



Note

Use only tow hitches approved by SEAT for the vehicle.

Maximum gross trailer weight

The instructions in the official vehicle documents take precedence. All the technical data provided in this documentation is applicable to the basic model. The vehicle data label in the Maintenance Programme or the vehicle documents show which engine is installed in your vehicle.

The figures may be different depending on if additional equipment is fitted, for different models and for special vehicles.

WARNING

Exceeding the maximum trailer weight indicated could cause a serious accident.

- **Never exceed the indicated trailer weight.**



CAUTION

Exceeding the maximum trailer weight indicated could cause damage to the vehicle.

- Never exceed the indicated trailer weight.

Gross combined vehicle weight rating

The instructions in the official vehicle documents take precedence. All the technical data provided in this documentation is applicable to the basic model. The vehicle data label in the Maintenance Programme or the vehicle documents show which engine is installed in your vehicle.

The figures may be different depending on if additional equipment is fitted, for different models and for special vehicles.

The maximum combined weights listed are only applicable for altitudes up to 1000 m above sea level. The weight of the car and trailer must be reduced by about 10% for every further 1000 m (or part thereof).

WARNING

Exceeding the maximum weight indicated could cause a serious accident.

- **Never exceed the gross combined weight rating.**

**CAUTION**

Exceeding the maximum gross combined weight rating indicated could cause damage to the vehicle.

- Never exceed the gross combined weight rating.



Vehicle maintenance and cleaning

Care and cleaning the vehicle exterior

Introduction

Regular maintenance and washing help to **maintain the value** of the vehicle. This may also be one of the requirements for acknowledging warranty claims in the event of bodywork corrosion or paint defects.

Products suitable for the care of your vehicle are available at any Technical Service.

Additional information and warnings:

- Care and cleaning of the vehicle interior ⇒ page 249
- Working in the engine compartment ⇒ page 275
- Accessories, parts replacement, repairs and modifications ⇒ page 257

WARNING

Car care products may be toxic and hazardous. If car care products are not suitable or are used inappropriately, this could result in accident, serious injury, burns or intoxication.

- Car care products must always be stored in the original container which should be kept closed.
- Observe information provided by the manufacturer.
- To prevent confusion, never store car care products in empty food cans, bottles or other containers.
- Keep all care products out of reach of children.

WARNING (Continued)

- Harmful vapours may be produced when using car care products. Therefore, care products should only be used in well-ventilated spaces or in the open air.
- Never use fuel, turpentine, engine oil, acetone or any other volatile liquid to wash, clean or care for the vehicle. These are toxic and highly flammable.

WARNING

- Inappropriate care and cleaning of vehicle components may effect the vehicle safety equipment, increasing the risk of severe injury.
- Vehicle components should only be cleaned and maintained in accordance with the manufacturer's instructions.
 - Only use approved or recommended care products.

CAUTION

Cleaning products which contain solvents will damage the material.

For the sake of the environment

- Only wash the vehicle in areas allocated for this purpose, to prevent dirty water which may be contaminated by oil, grease or fuel, from entering the drains. In some places, washing vehicles outside wash bays is prohibited.
- Where possible, always use products which respect the environment.
- The remains of car care products should not be disposed of with ordinary household waste. Observe information provided by the manufacturer. ■

Washing the vehicle

The longer substances such as insects, bird droppings, resinous tree sap, road dirt, industrial deposits, tar, soot or road salt and other aggressive materials remain on the vehicle, the more damage they do to the paintwork. High temperatures (for instance due to strong sunlight) further intensify the corrosive effect. The vehicle **undercarriage** should also be thoroughly washed at regular intervals.

Automatic car washes

Always observe the instructions provided at the automatic car wash. The standard precautionary measures prior to entering the car wash should be taken to avoid damage to the vehicle (close all windows, fold in exterior mirrors). If the vehicle is fitted with additional components (spoiler, roof-rack, aerial...), check with the car wash supervisor whether these can enter the car wash ⇒ ①.

The vehicle paintwork is so durable that the vehicle can normally be washed without problems in an automatic car wash tunnel. However, wear and damage to the paintwork will depend on the type of car wash used. SEAT recommends the use of car washed without brushes.

To remove traces of wax on windows and to prevent wiper blades from scratching, please observe the following ⇒ page 245, Cleaning windows and exterior mirrors.

Washing the car by hand

When washing the car by hand, use plenty of water to soften the dirt first, and rinse off as well as possible.

Then clean the vehicle with a soft **sponge, glove or brush** using only slight pressure. Start at the roof and work downwards. Special **car shampoo** should only be used for very persistent dirt.

Rinse the sponge or glove thoroughly and often.

Wheels, sills and similar should be cleaned last. Use a second sponge for this.



WARNING

Sharp components on the vehicle may cause injury.

- **Protect arms and hands from sharp edges when cleaning the vehicle undercarriage or the interior of the wheel hubs.**



WARNING

After the vehicle has been washed, the braking effect will be reduced (and the braking distance increased) due to moisture (and ice in winter) on the brakes.

- **Dry the brakes and remove ice by braking carefully. Ensure that you are not endangering other road-users or breaking traffic regulations in the process.**



CAUTION

- The temperature of the water must not exceed +60 °C (+140 °F).
- To avoid damage to the paintwork, do not wash the vehicle in full sun.
- Do not use rough sponges or similar which could damage the surface to clean away the traces of insects.
- Never wipe the headlights with a dry cloth or sponge, always moisten first. It is best to use soapy water.
- Washing the vehicle in low temperatures: When washing the vehicle with a hose, do not direct water into the lock cylinders or the gaps around the doors, tailgate, or sunroof. Locks and seals could freeze!



CAUTION

To prevent damage to the vehicle, please observe the following before entering **an automatic car wash**:

- Compare the distance between the vehicle wheels and the distance between the guide-rails of the car wash to prevent damage to the wheels and tyres!

- Switch off the rain sensor and the Auto Hold function before entering a car wash.
- Compare the height and width of your vehicle with the available height and width when entering and driving through the car wash.
- Fold in exterior mirrors. Electrically retractable exterior mirrors must NOT be folded in or out by hand. Always use the electrical power control.
- To avoid damaging the bonnet paintwork, rest the wipers on the windscreen after drying them. Do not let them fall!
- Lock the tailgate to prevent it from opening unexpectedly while inside the car wash.

Washing the vehicle with high pressure cleaning equipment

When cleaning the vehicle with a high-pressure cleaner, always follow the operating instructions for the equipment. Pay special attention to the required **pressure** of the jet and the **distance** between the jet and the vehicle ⇒ .

Keep a suitable distance from soft materials, such as rubber hoses or insulating material, and from the parking distance warning system sensors. The parking distance sensors are fitted in the rear bumpers and, where applicable, in the front bumpers ⇒ .

Do not use a nozzle that sprays the water out in a **direct stream** or one that has a **rotating jet** for forcing off dirt ⇒ .

WARNING

The incorrect use of high pressure cleaning equipment could result in permanent damage, visible or invisible, to the tyres or other materials. This could result in serious accident.

- Ensure there is a suitable distance between the nozzle and the tyres.
- Never wash tyres with a concentrated jet or so-called “dirt blasters”. Even at large spraying distances and short cleaning times, you may damage the tyres.

WARNING

After the vehicle has been washed, the braking effect will be reduced (and the braking distance increased) due to moisture (and ice in winter) on the brakes.

- Dry the brakes and remove ice by braking carefully. Ensure that you are not endangering other road-users or breaking traffic regulations in the process.

CAUTION

- The temperature of the water must not be above +60 °C (+140 °F).
- To avoid damage to the paintwork, do not wash the vehicle in full sun.
- The sensors on the bumpers should be kept clean and free of ice at all times to ensure the parking distance warning system and the parking aid system operate correctly. When cleaning with pressure hoses and steam cleaners, the sensors should be sprayed only briefly. A distance of 10 cm between the sensors and the steam / hose nozzle must be observed.
- Do not use a high pressure cleaner to remove ice or snow from windows
- Washing the vehicle in low temperatures: When washing the vehicle with a hose, do not direct water into the lock cylinders or the gaps around the doors, tailgate, or sunroof. Locks and seals could freeze!

Cleaning windows and exterior mirrors

Cleaning windows and exterior mirrors

Spray windows and exterior windows with a standard window cleaner containing alcohol.

Dry the windows with a clean chamois leather or a lint-free cloth. The chamois leathers used on painted surfaces are not suitable for cleaning windows because they are soiled with wax deposits which could smear the windows.

Use window cleaner or a silicone remover to clean rubber, oil, grease and silicone deposits off ⇒ ①.

Removing wax deposits

Automatic car washes and certain car care products may leave **wax deposits** on the windows. These deposits can only be removed with a special product or cleaning cloths. Wax deposits on the windscreen could cause the wiper blades to judder. SEAT recommends you wipe the wax deposits off the windscreen with a soft cloth each time after you have washed the vehicle.

A window cleaning detergent which helps to dissolve the wax may be added to the windscreen washer fluid to prevent the wiper blades from scratching the windscreen. Please ensure the you add the cleaning product in the correct proportions. Products for removing grease do not eliminate the wax deposits ⇒ ①.

Special cleaning products or window cloths are available at any Technical Service. To remove wax deposits, SEAT recommends the following products:

- For the hottest time of the year: the window cleaner for summer use G 052 184 A1. Proportion 1:100 (1 part detergent, 100 parts water) in the windscreen washer bottle.
- All year round: the window cleaner G 052 164 A2; proportion 1:2 in windscreen washer bottle (1 part concentrate, 2 parts water) in winter, up to -18 °C (-0.4 °F), or 1:4, during the rest of the year.
- Window cloths G 052 522 A1 for all windows and exterior mirrors.

Removing snow

Use a small brush to remove snow from the windows and exterior mirrors.

Removing ice

If possible, use a de-icing spray to remove ice. If you use an ice scraper, push it in one direction only **without** swinging it. If you pull the scraper backwards, the dirt may scratch the window.



WARNING

Dirty or misted windows reduce visibility in all directions and increase the risk of accident and serious injury.

- **Do not drive unless you have good visibility through all windows!**
- **Remove ice and snow from the windows and demist inside and out.**



CAUTION

- Never mix our cleaning products with other products not recommended by SEAT in the windscreen washer bottle. This could lead to flocculation and may block the windscreen washer jets.
- Do not use hot or warm water to remove ice or snow from the windows and exterior mirrors. The glass could crack!
- The heating element for the rear window is located on the inner side of the window. Do not stick adhesive labels over the heating elements and never clean the inside of the rear window with corrosive or acid products or other similar chemical cleaning products.
- Aerials on the inside of windows may be damaged if knocked or if cleaned with corrosive or acid cleaning products. Do not stick adhesive labels over the heating elements and never clean the inside of the rear window with corrosive or acid products or other similar chemical cleaning products.

Cleaning and changing windscreen wiper blades

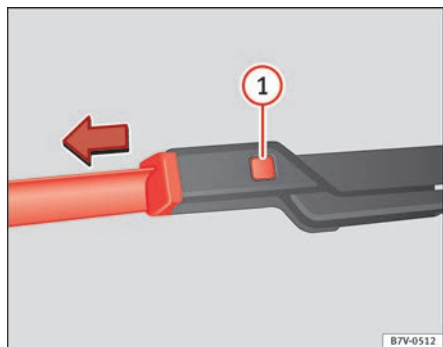

Fig. 158 Changing the front wiper blades

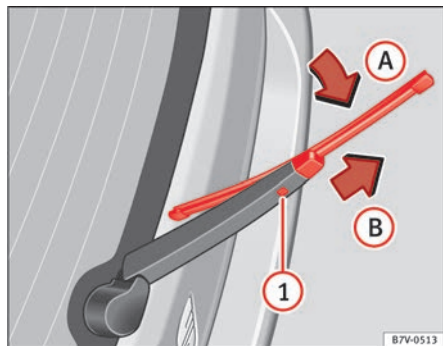

Fig. 159 Changing the rear wiper blade.

The windscreen wiper blades are supplied as standard with a layer of graphite. This layer is responsible for ensuring that the wipe is silent. If the graphite layer is damaged, the noise of the water as it is wiped across the windscreen will be louder.

Check the condition of the wiper blades regularly. **If the wipers scrape across the glass** they should be changed if they are damaged, or cleaned if they are dirty ⇒ ①.

Damaged wiper blades should be replaced immediately. Blades are available from qualified workshops.

Lifting and unfolding the wiper arms

The wiper arm may **only** be lifted at the point where it is fastened to the blade.

For windscreen wipers, please note: the wiper should be in service position before unfolding it ⇒ page 105.

Cleaning windscreen wiper blades

- Lifting and unfolding the wiper arms.
- Use a soft cloth to remove dust and dirt from the windscreen wiper blades.
- If the blades are very dirty, a sponge or damp cloth may be used ⇒ ①.

Changing the front wiper blades

- Lifting and unfolding the wiper arms.
- Hold down the release button ⇒ fig. 158 ① while gently pulling the blade in the direction of the arrow.
- Fit a new wiper blade of the **same length and design** on to the wiper arm and hook it into place.
- Rest the wiper arms back onto the windscreen.

Changing the rear wiper blade

- Lift and unfold the wiper arm.
- Pull the wiper blade out of its mounting on the wiper arm ⇒ fig. 159 (arrow ①).
- Hold down the release button ① while gently pulling the blade in the direction of the arrow ②. This may require some strength. ▶

- Insert a new blade of the **same length and type** in the wiper arm in the opposite direction to the arrow (B) and hook into place. This feature is operational when the knob is in position (arrow (A)).
- Replace the wiper arm on the rear window.

WARNING

Worn or dirty wiper blades reduce visibility and increase the risk of accident and serious injury.

- **Always replace damaged or worn blades or blades which do not clean the windscreen correctly.**

CAUTION

- Damaged or dirty windscreen wipers could scratch the glass.
- If products containing solvents, rough sponges or sharp objects are used to clean the blades, the graphite layer will be damaged.
- Never use fuel, nail varnish remover, paint thinner or similar products to clean the windows.

Caring for and polishing the vehicle paintwork

Waxing

Regular waxing protects the paintwork. It is time to apply a good coat of wax when water no longer **forms droplets** and rolls off the **clean** paintwork.

Even if a **wax solution** is used regularly in the automatic car wash, SEAT recommends protecting the paint with a hard wax coating at least twice a year.

Polishing

Polishing is only necessary if the paint has lost its shine, and the gloss cannot be brought back by applying wax.

If the polish does not contain wax, a wax product should be applied after polishing.

CAUTION

- To prevent damage, car polish or hard wax should not be used on components painted in matt paint, plastic components and the glass headlamp and tail light covers.
- Do not polish the paintwork if it is dirty, apply polish in dusty or sandy zones.

Cleaning chrome parts

Clean chrome parts with a damp cloth. SEAT recommends the use of a chrome care product to clean stains and dirt from chrome surfaces. Use a soft dry cloth to polish chrome parts.

CAUTION

To prevent scratching chrome surfaces:

- Do not use abrasive products.
- Do not clean or polish chrome parts in a sandy or dusty environment.
- Do not polish dirty surfaces.

Caring for and cleaning anodized surfaces

It is not easy to detect the difference between aluminium and an anodized surface, for example, a radiator grille. However, anodized surfaces must not be treated in the same way as aluminium surfaces. Never use rough sponges or cloths to wipe away insect remains.

- Use a clean, damp, lint-free cloth to clean anodized surfaces.
- If there is a lot of dirt, use a special cleaning product which does not contain **solvents**.



CAUTION

To prevent damage to the anodized surfaces:

- Do not use products containing solvents.
- Do not use polish or hard wax.
- Do not use abrasive products.
- Do not polish anodized surfaces in sandy or dusty environments.
- Do not polish dirty surfaces.

Cleaning wheels

Cleaning steel wheels

Use an industrial cleaner to remove brake dust. Therefore, clean wheels regularly with a separate sponge.

Any damage to the paint on steel wheels should be touched up before the metal starts to rust.

Caring for and cleaning alloy wheels

Remove road salt and brake dust by washing the wheels approximately **once a fortnight**. Use an acid free detergent to clean the wheel rims. SEAT recommends treating the wheels thoroughly with a **wax compound** about once every three months.

It is important to remove road salt and brake dust by washing the wheels at regular intervals, otherwise the finish will be impaired.

Always use an acid-free detergent for alloy wheel rims. Car polish or other abrasive agents should not be used.

If the protective coating on the paint has been damaged (for example, hit by a stone), it should be repaired immediately. ■

Caring for rubber seals

The rubber seals on doors, windows, etc., remain flexible, provide a better seal and last longer if they are regularly treated with a product specifically designed for use on rubber.

Before applying the product, use a soft cloth to remove dust and dirt from the rubber seals. ■

De-icing the door lock cylinder

To de-ice the lock cylinders, SEAT recommend the use of genuine SEAT spray with lubricating and anti-corrosive properties.



CAUTION

The use of products containing degreasing agents to de-ice the locks may rust the lock cylinder. ■

Protection of vehicle undercarriage

The vehicle underbody is coated to protect it from chemical and mechanical damage. The protective coat on the undercarriage may wear through use while driving. Therefore, SEAT recommends that the protective coating on the undercarriage and on the running gear should be regularly checked, and repaired if necessary. ►

 **WARNING**

Additional underseal or anti-corrosion products could catch fire due to the high temperatures reached by the exhaust gas system and other engine components.

- Do not apply additional underseal or anti-corrosion products to the exhaust pipes, catalytic converters, heat shields or other parts of the vehicle which reach high temperatures.

Cleaning the engine compartment

The engine compartment of any motor vehicle is a potentially hazardous area ⇒ page 275.

The engine compartment should only be cleaned by qualified personnel. If it is not correctly cleaned, the anti-corrosion coating and consequently electrical components may be damaged. Moreover, water may filter directly into the vehicle interior through the water chamber ⇒ ①.

If the engine compartment is very dirty, always take the vehicle to a Technical Service for professional cleaning. SEAT recommends visiting a Technical Service.

Water box

The water box is in the engine compartment, between the windscreen and the engine, and beneath a perforated cover. Air is taken in through the water box from outside to the vehicle interior via the heating and air conditioning system.

Leaves and other loose objects should be regularly cleaned away from the water box either by hand or with a vacuum.

 **WARNING**

When working on the engine or in the engine compartment, there is a risk of injury, burns, accident or fire.

- Before starting work, please ensure you are familiar with the required procedure and the safety precautions ⇒ page 275.
- SEAT recommends you have this work performed by a qualified dealership.

 **CAUTION**

If water is manually poured into the water box (for example, using a high pressure cleaning appliance), this could cause significant damage to the vehicle.

 **For the sake of the environment**

Only wash the engine compartment in areas allocated for this purpose, to prevent dirty water which may be contaminated by oil, grease or fuel, from entering the drains. In some districts, the engine compartment may not be washed outside the wash bays provided for this purpose.

Caring for and cleaning the vehicle interior

Introduction

The dye from many items of modern clothing (e.g. dark jeans) is not always solid enough. Seat upholstery (material and leather), especially when light coloured, may visibly discolour if the dye comes out of clothing (even when used correctly). This is not an upholstery defect but indicates that the dye in the item of clothing is not solid enough. ▶

Additional information and warnings:

- Caring for and cleaning the vehicle exterior ⇒ page 242
- Accessories, parts replacement, repairs and modifications ⇒ page 257

 **WARNING**

Car care products may be toxic and hazardous. If car care products are not suitable or are used inappropriately, this could result in accident, serious injury, burns or intoxication.

- Car care products must always be stored in the original container which should be kept closed.
- Observe information provided by the manufacturer.
- To prevent confusion, never store car care products in empty food cans, bottles or other containers.
- Keep all care products out of reach of children.
- Harmful vapours may be produced when using car care products. Therefore, care products should only be used in well-ventilated spaces or in the open air.
- Never use fuel, turpentine, engine oil, acetone or any other volatile liquid to wash, clean or care for the vehicle. These are toxic and highly flammable.

 **WARNING**

Inappropriate care and cleaning of vehicle components may effect the vehicle safety equipment, increasing the risk of severe injury.

- Vehicle components should only be cleaned and maintained in accordance with the manufacturer's instructions.
- Only use approved or recommended care products.

 **CAUTION**

- Cleaning products which contain solvents will damage the material.
- To avoid damage, stubborn stains should be removed by a specialist cleaning company.

 **Note**

Suitable car care products are available from your Technical Service. ■

Treating your upholstery

Check list

For information on how to treat and care for the vehicle upholstery, please bear the following in mind ⇒ :

- Before entering the vehicle, fasten all Velcro fastenings which could come into contact with upholstery and coverings. If the Velcro fastenings on upholstery and material covers are not securely fastened, this could damage them.
- To prevent damage, do not allow the upholstery or covers to come into contact with sharp or decorative objects. Decorative objects such as zips, rivets and rhinestones on clothing and belts.
- Dust and grit in the pores and seams should be removed regularly to prevent them scratching and damaging the surface.
- Always check that the dyes used in clothing are fast to prevent them from staining the upholstery. This is particularly true for clear-coloured upholstery. ►

**CAUTION**

Failure to observe the instructions in the check list for caring for your upholstery could result in damage or discolouration of the upholstery and covers.

- Always follow the check list and perform the necessary operations.

**Note**

SEAT recommends you take the vehicle to a Technical Service to treat any stains on the upholstery caused by the discolouration of clothing. ■

Cleaning upholstery, textile covers and Alcantara® material

Normal cleaning

- Before applying cleaning products, please read the instructions for handling and the warnings shown on the container.
- The upholstery, textile covers, Alcantara® material and mats should be regularly vacuumed (with vacuum brush).
- We recommend that you use a soft sponge or lint-free, micro-fibre cloth for normal cleaning ⇒ ①.
- Clean Alcantara® surfaces with a damp lint-free cotton, wool or micro-fibre cloth used for normal cleaning ⇒ ①.

General superficial dirt on upholstery and textile covers can be cleaned with a normal foam cleaning product.

If the upholstery and the material trims are very dirty, we recommend you have them cleaned by a specialist cleaning form.

Cleaning stains

It may be necessary to clean the whole surface and not only the stain itself. Especially if the surface has been dirtied through normal use. Otherwise,

the stained area may become lighter than the rest of the surface after treatment.

Type of stain	Cleaning the vehicle
<i>Water-based stains</i> , e.g. coffee or fruit juice.	<ul style="list-style-type: none"> ▷ Use a sponge and wipe with a solution of water and wool wash. ▷ Dry the area gently with a soft dry cloth.
<i>Persistent stains</i> , e.g. chocolate or make-up.	<ul style="list-style-type: none"> ▷ Apply cleaning paste^{a)} directly to the stain and treat. ▷ Next, rinse with clean water using a sponge or damp cloth to remove the cleaning product deposits. ▷ Carefully dry the area with an absorbent dry cloth.
<i>Grease-based stains</i> , e.g. oil or lipstick.	<ul style="list-style-type: none"> ▷ Apply a neutral soap or cleaning paste^{a)} and treat the stain. ▷ Apply absorbent material to loose colourants or particles of grease. ▷ Then rinse the area with clean water. Take care not to soak the upholstery.

^{a)} Bile soap can be used as a cleaning paste.

**CAUTION**

- Brushes should only be used to clean the mats and floor mat! Other surfaces may be damaged if a brush is used.
- Do not use steam cleaning equipment, as the dirt becomes more incrustated in the material when steam is applied.
- Alcantara® upholsteries should never be soaked.
- Do not use leather cleaning products, solvents, wax polish, shoe cream, spot removers or similar products on Alcantara®.
- Never use brushes for cleaning damp material as they could damage the surface.
- Do not use steam cleaning equipment, as the dirt becomes more incrustated in the material when steam is applied. ■

Cleaning and care of real leather upholstery

In the event of query regarding the care or cleaning of the leather in your vehicle, please ask a Technical Service or specialised workshop.

Cleaning and care

Untreated Nappa is delicate as it is not covered with a layer of colour.

- Use a suitable impregnating cream with ultra-violet protection at regular intervals and after cleaning. This cream will nourish and moisturise the leather, keep it supple and able to breathe. It will also form a protective film.
- Clean the leather every two to three months and remove fresh dirt as necessary.
- Leather should be treated every six months with a suitable leather care product ⇒ ①.
- When using care and cleaning products, only apply the minimum required quantities.
- Remove stains from fresh ball-pen and other inks, lipstick, shoe cream and similar stains as soon as possible.
- Caring for coloured leather. A special coloured cream will renew the colour of the leather when required and will eliminate differences in colour.
- Then wipe off with a soft, dry cloth.

Cleaning the vehicle

SEAT recommends the use of a damp cotton or wool cloth for general cleaning.

Do not let the water soak through the leather or soak into the seams.

Type of stain	Cleaning the vehicle
<i>More stubborn dirt</i>	<ul style="list-style-type: none"> ▷ Apply a mild soap and water solution^{a)} using a cloth. (Squeeze out the cloth well before application). ▷ Carefully dry the area with an absorbent dry cloth.
<i>Water-based stains, e.g. coffee, tea, fruit juice, blood, etc.</i>	<ul style="list-style-type: none"> ▷ Remove fresh stains with an absorbent cloth. ▷ Use a suitable cleaning product to treat dried-in stains ⇒ ①.
<i>Grease-based stains, e.g. oil or lipstick, etc.</i>	<ul style="list-style-type: none"> ▷ Remove fresh stains with an absorbent cloth. ▷ Use a suitable cleaning product if the stain has not yet penetrated the surface ⇒ ①. ▷ Treat dry stains with a grease-removal spray ⇒ ①.
<i>Dry difficult stains, e.g. ink, felt-tip pen, nail varnish, pigment dispersions or shoe polish.</i>	<ul style="list-style-type: none"> ▷ Carefully dry the area with an absorbent dry cloth. ▷ Clean using a special stain remover suitable for use on leather.

^{a)} Mild soap and water solution: two table spoons of neutral soap per litre of water.

! CAUTION

- On no account use solvents, wax polish, shoe cream, spot removers or similar materials.
- In the event of spilt liquids, dry immediately with an absorbent cloth to prevent the liquid penetrating through the leather.

! CAUTION

If the car is left standing in the sun for long periods, the leather should be protected against direct sunlight to prevent it from fading.

i Note

However, slight colour variations will arise in normal use. ■

Cleaning leather upholstery

Only use water and neutral cleaning products to clean imitation leather upholstery.

CAUTION

On no account use solvents, wax polish, shoe cream, spot removers or similar materials on imitation leather. These will stiffen the material, making it more likely to crack sooner. ■

Cleaning storage compartments, drinks holders and ashtray

Cleaning storage compartments and drinks holders

Some storage compartments and drinks holders have a removable rubber mat.

- Use a clean, damp, lint-free cloth to clean parts.
- If this does not provide satisfactory results, we recommend using a special **solvent-free** plastic cleaning product.

Cleaning the ashtray

- Extract the ashtray and empty it.
- Clean the ashtray with a dishcloth.

Use a toothpick or similar to remove ash from the area where cigarettes are stubbed out. ■

Care and cleaning of plastic parts, wooden trim and the instrument panel

- Use a clean, damp, lint-free cloth to clean parts.
- Clean plastic parts (*inside and outside the vehicle*) and the instrument panel with a special **solvent-free** product for the care and cleaning of plastic, approved by SEAT ⇒ .
- Wash wooden trims with a mild soap and water solution.

WARNING

Solvents cause the surfaces of the airbag modules to become porous. If an airbag is accidentally triggered, the detachment of plastic parts could cause serious injury.

- Never clean the instrument panel and the surfaces of the airbag modules with cleaners containing solvents. ■

Cleaning seat belts

If the seat belt is very dirty, the belt retractor may not work correctly thus preventing the seat belt from operating correctly.

The seat belts should never be removed from the vehicle for cleaning.

- Use a soft brush to remove the worst dirt ⇒ .
- Pull the seat belt right out and leave it out.
- Clean dirty seat belts with a *gentle* soap and water solution.
- Wait until they are completely dry.
- Only allow the seat belt to retract when it is completely dry. ►

**WARNING**

Check the condition of all the seat belts at regular intervals. If the webbing or other parts of the belt are damaged, the vehicle should be taken to a Technical Service immediately and the belts should be replaced. It is extremely dangerous to drive using damaged seat belts and could result in serious injury or loss of life.

- Seat belts and their components must never be cleaned with chemical products, nor should they be allowed to come into contact with corrosive liquids, solvents or sharp objects. This could affect the strength of the seat belt webbing.
- Seat belts should be completely dry before retracting. Damp could damage the belt retractor so that it does not operate correctly.
- Do not allow liquids or foreign bodies to enter the buckle fastenings. This could damage the buckles and seat belts.
- Never attempt to repair, modify or remove a seat belt yourself.
- Always have damaged seatbelts replaced immediately by seat belts approved for the vehicle in question by SEAT. Seat belts which have been worn in an accident and stretched must be replaced by a specialised workshop. Renewal may be necessary even if there is no apparent damage. The belt anchorage should also be checked.

Notes for the user

Labels and plates

Some parts in the engine compartment come from the factory with certificates of safety, labels or plates containing important information regarding the operation of the vehicle, for example, on the petrol cap, on the passenger's sun visor, on the driver's door strut, or on the floor of the luggage compartment.

- Never remove these certificates of safety, labels or plates, and ensure they are kept in good condition and are legible.
- If a vehicle part, bearing a certificate of safety, label or plate, is replaced, the qualified workshop should attach the information back in the same place.

Certificate of safety

A certificate of safety on the door strut states that all the safety standards and regulations established by the national traffic authorities responsible for road safety were met at the time of manufacture. It may also give the month and year of manufacture, together with the chassis number.

Warning of high voltage label*

There is a label close to the bonnet lock which warns of high voltage in the vehicle electrical installation. The vehicle ignition system complies with several standards, including the Canadian standard, ICES-002. ■

Using your vehicle in other countries and continents

The vehicle is manufactured at the factory for use in a particular country in accordance with the national legislation in force at the time of manufacture.

If the vehicle is sold in another country or used in another country for an extended period of time, the applicable legislation of that country should be observed.

It may be necessary to fit or remove certain pieces of equipment or to deactivate certain functions. Service work may also be affected. This is particularly true if the vehicle is used in a different climate for an extended period of time.

As there are different types of frequency bands around the world, you may find that the radio or navigation system supplied at the factory does not work in another country.



CAUTION

- SEAT does not accept liability for any damage to the vehicle due to the use of a lower quality fuel, an inadequate service or the non-availability of genuine spare parts.
- SEAT does not accept liability if the vehicle does not comply in part or in full with the legal requirements of other countries or continents. ■

Radio reception and the aerial

The aerial of radio and navigation systems fitted at the factory may be mounted in different parts of the vehicle:

- On the inside of the rear window, next to the rear window heating,
- on the inside of the rear side windows,
- on the inside of the windscreen,
- on the roof of the car.

Aerials mounted on the inside of a window can be recognised by the fine wires. ►

CAUTION

Aerials on the inside of windows may be damaged if knocked or if cleaned with corrosive or acid cleaning products. Do not stick adhesive labels over the heating elements and never clean the inside of the rear window with corrosive or acid products or other similar chemical cleaning products.

Note

If electrical equipment is used near an aerial built-into the window, you may observe interference in the reception of AM stations. ■

Please see your Technical Service for further information about the collection and scrapping of end-of-life vehicles.

Scrapping

The relevant safety requirements must be observed when the vehicle or components of the airbag or belt tensioner systems are scrapped. These requirements are known to qualified dealerships. ■

Notes on SEAT repairs

WARNING

Repairs or modifications which are not performed correctly may result in damage or errors in the vehicle operation, affecting the efficiency of the driver assist and airbag systems. This could result in serious accident.

- Have any repairs or modifications carried out at a Technical Service. ■

Collection and scrapping of end-of-life vehicles

Collection of end-of-life vehicles

An extensive network of used car reception centres already exists in much of Europe. After the vehicle has been delivered, you will receive a certificate of destruction describing the environmentally friendly scrapping of the vehicle in accordance with applicable legislation.

We will collect the used vehicle free of charge, provided it complies with all national legislation.

Accessories, parts replacement and modifications

Accessories, replacement of parts and modifications

Introduction



WARNING

The use of spare parts and accessories, or incorrectly performed modifications or repairs may result in damage to the vehicle, accidents and serious injury.

- SEAT strongly recommends you to only use SEAT approved accessories and SEAT® original spare parts. These parts and accessories have been specially tested by SEAT for suitability, reliability and safety.
- Have any repairs or modifications carried out at a Technical Service. Qualified workshops have the necessary tools, diagnostics equipment, repair information and qualified personnel.
- Only mount parts with the same specifications as the parts fitted at factory.
- Never mount, fasten or fit objects such as drink holders or telephone cradles over the covers of the airbag modules or within their radius of action.
- Only use wheels and tyre combinations which have been approved by SEAT for your vehicle type.

Accessories and spare parts

SEAT recommends you consult an Official Service before purchasing accessories and spare parts or consumables. For example, when fitting accesso-

ries at a later date, or when replacing a component. A Technical Service will advise you as to the legal requirements and manufacturer's recommendations regarding accessories, spare parts and other components.

SEAT recommend you use only approved **SEAT accessories** and **genuine SEAT spare parts**®. These parts and accessories have been specially tested by SEAT for suitability, reliability and safety. In addition the Technical Service will guarantee that the assembly is carried out professionally.

Although we continually monitor the market, SEAT cannot guarantee that products **not approved by SEAT** are reliable, safe and suitable for the vehicle. Therefore, SEAT cannot accept liability, even in those cases authorised by an officially recognised technical inspection office or other official body.

Any **retro-fitted equipment** which has a direct effect on the vehicle and/or the way it is driven must be approved by SEAT for use in your vehicle and bear the **e** mark (the European Union's authorisation symbol). This includes cruise control systems or electronically controlled suspension.

If any **additional electrical components** are fitted which do not serve to control the vehicle itself, these must bear the **CE** mark (European Union manufacturer conformity declaration). This includes refrigerator boxes, laptops or ventilator fans.



WARNING

Unprofessional repairs or modifications to the vehicle may affect the performance of the airbags, resulting in operating faults or fatal accident.

- Never mount, fasten or fit objects such as drink holders or telephone cradles over the covers of the airbag modules or within their radius of action.
- Objects placed over the airbag covers, or within their radius of action, could lead to serious injury or loss of life if the airbags are triggered.

Fluids and consumables

All **vehicle fluids and consumables**, such as notched belts, tyres, coolant fluids, engine oils, spark plugs and batteries are continually being developed. Therefore all fluids and consumables should be changed at a Technical Service. Qualified workshops are permanently informed of any modifications.



WARNING

The incorrect use or handling of fluids or consumables may result in accident, serious injury, burns or intoxication.

- Therefore, fluids must always be stored closed in their original container.
- Never store fluids in empty food containers or bottles as other people may accidentally drink the fluid.
- Keep all fluids and consumables out of reach of children.
- Read and observe the information and warnings given on the fluid containers.
- Only work in the open air or in well-ventilated zones, when using products which give off harmful vapours.
- Never use fuel, turpentine, engine oil, acetone or any other volatile liquid in the maintenance of the vehicle. These are toxic and highly flammable. They could lead to fire or explosions!



CAUTION

- Only use appropriate fluids. Never mix the fluids. Using the wrong fluids could cause serious malfunctions and engine damage!
- Accessories and other components mounted in front of the air inlet reduce the cooling effect of the coolant. If the engine is running under great strain in high outside temperatures, it could overheat.



For the sake of the environment

Leaking fluids could pollute the environment. Collect any spilt fluids in suitable containers and dispose of in accordance with legislation and with respect for the environment. ■

Repairs and technical changes

When performing repairs and technical modifications, SEAT's directives must be observed! ⇒

Unauthorised modifications to the electronic components or software in the vehicle may cause malfunctions. Due to the way the electronic components are linked together in networks, other indirect systems may be affected by the faults. This may significantly affect the vehicle's performance, increase component wear and could mean that the vehicle registration documents are no longer valid.

Your Technical Service cannot be held liable for any damage caused by technical modifications or repairs performed incorrectly.

The Technical Service does not accept liability for damage resulting from technical modifications or repairs performed incorrectly; neither is the SEAT warranty valid in these cases.

SEAT recommends you have any technical modifications or repairs performed at a SEAT authorised service and that you use **genuine SEAT spare parts**®.

Vehicles with special accessories and equipment

The manufacturers of additional equipment guarantee that the equipment complies with applicable laws and regulations with respect to the environment, in particular Directives 2000/53/CE and 2003/11/CE. The first directive governs the disposal of end-of-life vehicles while the second refers to the restrictions on the marketing and use of certain dangerous substances and preparations. ►

The vehicle owner should keep the documentation for the additional equipment safely and hand it over to the scrap yard at the end of the vehicle's service life. This ensures that any additional equipment mounted in end-of-life vehicles is correctly disposed of with respect for the environment.

 **WARNING**

Repairs or modifications which are not performed correctly may result in damage or errors in the vehicle operation, affecting the efficiency of the driver assist systems. This could result in serious accident.

- All repairs and modifications to the vehicle should only be performed by a specialised workshop.

Repair and faults in the airbag system

When performing repairs and technical modifications, SEAT's directives must be observed! ⇒ 

Modifications and repairs to the front bumper, doors, front seats, and repairs to the roof or chassis should only be carried out in a Technical Service. These components may contain parts or sensors belonging to the airbag system.

If work is carried out on the airbag system or parts have to be removed and fitted on the system when performing other repair work, parts of the airbag system may be damaged. The consequence may be that, in the event of an accident, the airbag inflates incorrectly or does not inflate at all.

So that the effectiveness of the airbag is not reduced and that removed parts do not cause any injuries or environmental pollution, regulations must be observed. These requirements are known to qualified dealerships.

Modifications to the vehicle suspension may affect the operation of the airbag system in the event of collision. For example, if wheel and tyre combinations not approved by SEAT are used, or if the vehicle height is lowered,

the suspension is stiffened or the suspension springs, telescopic arms, dampers, etc., are modified, the results received by the airbag sensors and sent to the control unit may not be accurate. For example, some modifications to the suspension could increase the force measured by the sensors and result in the triggering of the airbag systems in collisions. Under normal conditions, the measured values would be lower and the airbag would not have been triggered. Other modifications may reduce the forces measured by the sensors and therefore the airbags are not triggered in situations when they should have triggered.

 **WARNING**

Repairs or modifications which are not performed correctly may result in damage or errors in the vehicle operation, affecting the efficiency of the airbag systems. This could result in serious or fatal accident.

- All repairs and modifications to the vehicle should only be performed by a specialised workshop.
- Airbag modules must never be repaired: if damaged, they must be replaced.
- Never fit recycled or reused airbag components in your vehicle.

 **WARNING**

Modifications to the vehicle suspension, including the use of unauthorised wheel and tyre combinations, may affect the performance of the airbags and increase the risk of serious or fatal injury in the event of accident.

- Never fit suspension components which are not identical to the original parts mounted in the vehicle.
- Never use wheel and tyre combinations not approved by SEAT.

Retro-fitting of two-way radios

An exterior aerial is required for the use of two-way radios in the vehicle.

The retro-fitting of electrical or electronic appliances in the vehicle is subject to their approval for use in your vehicle. Under certain circumstances, this could mean that your vehicle registration documents are no longer valid.

SEAT has approved your vehicle for use with two-way radios providing the following conditions are observed:

- The exterior aerial must be mounted professionally.
- The maximum transmitting power is 10 watts.

An only external aerial is needed to give the equipment its optimal reach.

Check first with a qualified dealer if you wish to use a two-way radio with a transmitting power of over 10 watts. The qualified workshops are familiar with the technical options for installation. SEAT recommends visiting a Technical Service.

All legal requirements, together with the instructions for the use of two-way radios must be observed.

WARNING

If the two-way radio is not securely fastened in position, it could be sent flying around the vehicle in the event of sharp braking, sudden manoeuvres or accident, causing injury.

- **While driving, two-way radios must be securely fastened in position, outside the radius of action of the airbags, or safely stowed away.**

WARNING

When using a two-way radio without a connection to an exterior aerial, the maximum permitted levels of electromagnetic radiation may be exceeded. This is also the case if the aerial has not been correctly installed.

- **You should only use a two-way radio inside the vehicle if it has first been correctly connected to an exterior aerial.**

Information stored by the control units

Your vehicle is fitted at the factory with a series of electronic control units responsible for the engine and gearbox management. In addition, the control units supervise the performance of the exhaust gas system and the air-bag systems.

Therefore, while the vehicle is being driven, these electronic control units are continuously analysing the vehicle data. In the event of faults or deviations from the theoretical values, only this data is stored. Normally, the warning lamps on the instrument panel light up in the event of faults.

This data can only be read and analysed using special equipment.

The storing of the data allows specialised workshops to detect and repair faults. Stored data may include:

- Data relating to the engine or the gearbox
- Speed
- Direction of travel
- Braking force
- Detection of seat belt

The vehicle control units never record conversations held by passengers in the vehicle. ►

In vehicles equipped with an emergency call function via the mobile phone or other appliances connected in the vehicle, it is possible to send the vehicle position. If the control unit records an accident with airbag activation, the system may automatically send a signal. This will depend on the network operator. Normally, transmission is only possible in areas with good coverage.

Event Data Recorder

The vehicle is **not** fitted with an event data recorder.

An event data recorder temporarily stores the vehicle information. Therefore, in the event of accident, it is possible to obtain detailed information about how the accident occurred. For example, in vehicles with airbag systems, data relating to speed of impact, seat belt status, seat positions and airbag activation times may be stored. The volume of data depends on the manufacturer.

Event data recorders can only be mounted with authorisation from the vehicle owner and, in some countries, they are governed by local legislation.

Reprogramming control units

On the whole, all the data required for the component management is stored in the control units. The programming of certain convenience functions, such as the convenience indicators, individual door opening and instructions on the display can be modified using special equipment at the workshop. If this is the case, the information and descriptions given in the instructions manual will not match the original functions. Therefore, SEAT recommends that any modifications are recorded in the section "Other workshop notes" in the Maintenance Programme.

The Technical Service must have a record of any modification to the programming.

Reading the vehicle fault memory

There is a diagnostics connector in the vehicle interior for reading the vehicle fault memory. The fault memory documents errors and deviations from the theoretical values of the electronic control units.

The diagnostics connector is in the driver's side footwell area, next to the lever for opening the bonnet, below a cover.

The fault memory should only be read and reset by a Technical Service. ■

Using a mobile telephone in a vehicle without connection to an exterior aerial

Mobile telephones transmit and receive radio waves, both when in use and when on stand-by. Scientific studies state that radio waves exceeding certain values may be harmful to the human body. International committees and authorities have established limits and directives in order to ensure electromagnetic radiation from mobile phones remains within certain limits that do not endanger human health. However, there is no available conclusive scientific evidence that cordless phones are completely safe.

Therefore, some experts recommend that use of mobile phone be kept to a minimum until the results of current research are published.

When a mobile phone not connected to an exterior aerial is used inside the vehicle, the electromagnetic radiation may be greater than if the mobile phone were connected to a built-in aerial or to another exterior aerial.

If the vehicle is fitted with a suitable hands-free device, it will comply with the legislation in many countries which only permits the use of mobile phones inside vehicles using a hands-free device.

The hands-free system mounted at the factory has been designed for use with conventional mobile phones and phones with Bluetooth technology. Mobile phones should be placed on a suitable phone cradle. In addition, the cradle should always be correctly fitted into the base plate. This ensures that the mobile phone is securely fastened to the instrument panel and connected to the exterior aerial of the vehicle.

If the mobile phone is connected to an aerial incorporated into the vehicle or an exterior aerial connected to the vehicle, this will help to reduce the ►

electromagnetic radiation transmitted and the risk to human health. It will also improve the quality of the connection.

If the phone is used inside the vehicle without the hands-free system, it will not be securely fastened and will not be connected to the exterior aerial of the vehicle telephone. Nor will the telephone charge if it is not on the support. In addition, some calls may break off and the quality of the connection will be affected.

Mobile phones should only be used inside the vehicle if they are connected to a hands-free system with an exterior aerial.

! WARNING

If the mobile phone is not securely fastened in position, it could be sent flying around the vehicle in the event of sharp braking, sudden manoeuvres or accident, causing injury.

- While driving, mobile phones must be securely fastened in position, outside the radius of action of the airbags, or safely stowed away.

! WARNING

When using a mobile phone without a connection to an exterior aerial, the maximum permitted levels of electromagnetic radiation may be exceeded. This is also the case if the aerial has not been correctly installed.

- A minimum of 20 centimetres should be kept between mobile phone aerials and artificial pacemakers, as mobile telephones may affect the working of pacemakers.
- Do not carry a mobile phone in your breast pocket directly over the pacemaker when the phone is switched on.
- If you suspect interference, switch the mobile phone off immediately.

Jacking points for raising vehicle

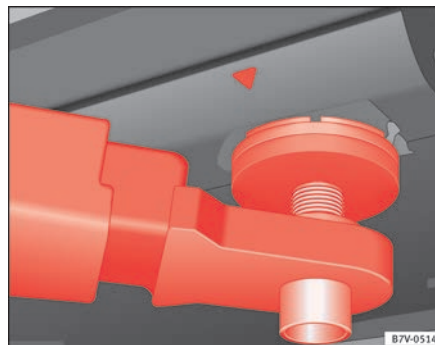

Fig. 160 Front jacking points for raising vehicle with lifting platform or jack.

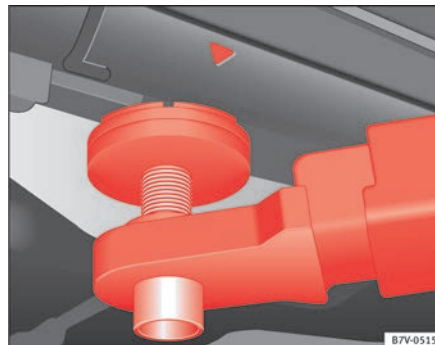

Fig. 161 Rear jacking points for raising vehicle with lifting platform or jack.

Always use the jacking points indicated in the figures ⇒ fig. 160 and ⇒ fig. 161 when raising the vehicle. If the vehicle is not lifted at these points, it could be seriously damaged ⇒ ⚠ or lead to serious injury ⇒ ⚠.

The vehicle should not be lifted using lifting platforms with lift pads containing fluid.

When raising a vehicle using a platform or jack, a series of precautionary measures are required. Never raise the vehicle with a lifting platform or jack unless you have received training in how to do so and know how to lift the vehicle safely.

Notes on raising the vehicle with a jack ⇒ page 309.



WARNING

The improper use of the lifting platform or the jack when raising the vehicle may result in accidents or serious injury.

- Before raising the vehicle, please observe the manufacturer's instructions for the platform or jack, and the legal requirements, where applicable.
- There should not be anyone inside the vehicle when it is being raised or once it is in the air.
- Only use the jacking points indicated in the figures ⇒ **fig. 160** and ⇒ **fig. 161** when raising the vehicle. If the vehicle is not lifted at the indicated points, it may fall from the platform while the engine or gearbox is being dismantled, for example.
- The jacking points should be centrally aligned and firmly positioned on the platform support plates.
- Never start the engine when the vehicle is raised! The vehicle may fall from the platform due to the engine vibrations.
- If it is necessary to work underneath the vehicle while it is raised, you should check that the supporting stands have an adequate load capacity.
- Never climb onto the lifting platform.
- Always make sure that the weight of the vehicle does not exceed the lifting platform load capacity.



CAUTION

- Never raise the vehicle at the engine oil sump, the gearbox or the rear or front axles.
- Always use an **intermediate rubber support** to prevent damage to the vehicle underbody. Check that the arms of the lifting platform are able to move with obstruction.
- The arms should not come into contact with the side running boards or other parts of the vehicle. ■

Checking and refilling levels

Filling the tank

Introduction

The fuel tank flap is on the rear right of the vehicle.

Additional information and warnings:

- Fuel ⇒ page 267
- Selective Catalytic Reduction (AdBlue) ⇒ page 271
- Working in the engine compartment ⇒ page 275

WARNING

Refuelling or handling fuel carelessly can cause an explosion or fire resulting in serious burns and injuries.

- Always make sure that you correctly close the fuel cap to avoid evaporation and fuel spillage.
- Fuels are highly explosive and inflammable substances that can cause serious burns and injuries.
- Fuel could leak out or be spilled if the engine is not switched off or if the filler fuel nozzle is not fully inserted into the tank filler neck when refuelling. This could lead to a fire, explosion and severe injuries.
- When refuelling, turn off the engine, the auxiliary heating (⇒ page 163) and turn off the ignition for safety reasons.
- Always turn off mobile telephones, radio apparatus and other radio wave emitting equipment before refuelling. Electromagnetic waves could cause sparks and lead to a fire.

WARNING (Continued)

- Never enter the vehicle while refuelling. If it is absolutely necessary to enter the vehicle, close the door and touch a metal surface before touching the filler nozzle again. This will prevent the generation of static electricity. Sparks could cause a fire when refuelling.
- Never handle fuel close to open flames, sparks or objects with slow combustion (e.g. cigarettes).
- Avoid static electricity and electro-magnetic radiation when refuelling.
- Observe the safety regulations of the service station.
- Never spill fuel on the vehicle or in the luggage compartment.

WARNING

For safety reasons, SEAT does not recommend carrying a spare fuel canister in the vehicle. Fuel could be spilled and catch fire, above all in case of an accident and this applies to a full container as well as empty containers. This could lead to explosions, fires and injuries.

- Observe the following if you exceptionally have to carry fuel in a canister:
 - Never place a fuel container to fill it inside the vehicle or on the vehicle, for example, in the luggage compartment or on the tailgate. Filling in these circumstances could create an electrostatic charge and spark that could ignite fuel fumes.
 - Always place the canister on the ground to fill it.
 - Insert the fuel nozzle into the mouth of the canister as far as possible.

⚠ WARNING (Continued)

- If you are using a metal fuel canister, the nozzle must always touch the canister while it is being filled to avoid static electricity.
- Follow the legal requirements for the use, storage and transport of spare fuel canisters.
- Insure that the fuel container complies with manufacturing standards, for example, ANSI or ASTM F852-86.

! CAUTION

- Always remove any fuel spilled on the vehicle paintwork immediately to avoid damage to the wheel housing, the tyre and vehicle paintwork.
- Refuelling a petrol engine with diesel or a diesel engine with petrol can cause serious engine and fuel system damage; the resulting malfunctions are not covered by the SEAT warranty. If you refuel with the wrong type of fuel, never start the engine. This applies to even the smallest amount of the wrong fuel. You should obtain professional assistance. With the engine running, the composition of the wrong fuel could significantly damage the fuel system and the engine itself.
- In vehicles with a diesel engine, **under no circumstances** should you refuel or drive with petrol, kerosene, heating oil or any other type of different fuel. Other types of fuels could cause serious damage to the engine and to the fuel supply system and the resulting problems are not covered by the SEAT warranty.

🌿 For the sake of the environment

Fuels can contaminate the environment. Collect any spilt service fluids and allow a professional to dispose of them.

i Note

There is no emergency mechanism for the manual release of the tank flap. If necessary, request assistance from specialised personnel. ■

Control lamps and fuel gauge



Fig. 162 On the instrument panel: Fuel gauge for petrol and diesel.

lights up	Gauge position ⇒ fig. 162	Possible cause ⇒ ⚠	Solution
	Red mark (arrow)	The fuel tank is almost empty. The reserve tank is being used ⇒ page 363.	Refuel as soon as possible ⇒ Ⓜ.
		Fuel tank not closed correctly.	Stop the vehicle and close the tank flap properly.

Several warning and control lamps should light up for a few seconds when the ignition is switched. This signals that the lamp is working properly. They will switch off after a few seconds.

When the control lamp lights up or the auxiliary heater and the auxiliary heater running off petrol automatically switch off. ▶

WARNING

Driving with insufficient fuel reserve could result in the vehicle breaking down in traffic and a serious accident.

- If the fuel level is too low then the fuel supply to the engine can become irregular especially on slopes.
- If the engine “is choked” or stalls due to lack of or irregularity of the fuel supply, the power steering as well as all of the driver assistance systems including braking assistance will stop working.
- Always refuel when there is only one quarter of the fuel tank left to avoid running out of fuel.

CAUTION

- Always pay attention to any lit lamps and to the corresponding descriptions and instructions to avoid damage to the vehicle.
- Never run the tank completely dry. An irregular fuel supply may lead to ignition faults and unburnt fuel could enter the exhaust system. This could damage the catalytic converter filter or the diesel particulate filter!

Note

The arrow next to the fuel pump symbol on the instrument panel ⇒ fig. 162 indicates the side of the vehicle on which the tank flap is located. ■

Filling the tank with petrol or diesel

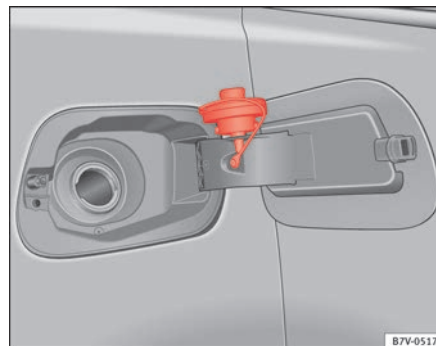

Fig. 163 Open tank flap with tank cap attached to the holder.

Before refuelling, always turn off the engine, the ignition, mobile telephones, auxiliary heating and keep them off during refuelling.

Unscrewing the tank cap

- The tank flap is at the rear of the vehicle on the right.
- Press the rear of the tank flap to open it.
- Unscrew the tank cap anti-clockwise and insert it in the hole in the tank flap hinge ⇒ fig. 163.

Refilling

The correct petrol type for the vehicle is located on a sticker inside the fuel tank flap ⇒ page 267.

- If the automatic filler nozzle is operated correctly, it will switch itself off as soon as the tank is *full* ⇒ .
- Do not continue to refuel if it is turned off! Otherwise, this will fill the expansion chamber and fuel may leak out if the ambient conditions are warm. ►

Closing the tank cap

- Screw on the tank cap clockwise until it you hear it click into position.
- Press the tank flap until you hear it click into place. The tank flap must be flush with the body contour.



WARNING

Do not continue refilling once the fuel nozzle has switched itself off. The fuel tank may be filled too much. As a result, fuel may spurt out and spill. This could lead to a fire, explosion and severe injuries.



CAUTION

- Always remove any fuel spilled on the vehicle paintwork immediately to avoid damage to the wheel housing, the tyre and vehicle paintwork.



For the sake of the environment

Spilt fuel can contaminate the environment. ■

Refilling precautions

Information on bulb replacement ⇒ page 326.

Checklist

Never work on the engine or in the engine compartment if you are not familiar with the operations to be carried out, the applicable safety standards and especially if you do not have the instruments, liquids and tools necessary ⇒ page 275, Working in the engine compartment! Have the work carried out by a specialised workshop if you are uncertain. Check the following regularly, preferably when you refuel:

- Windscreen washer fluid level ⇒ page 105
- Engine oil level ⇒ page 279

- Engine coolant level ⇒ page 283
- Brake fluid level ⇒ page 183
- Tyre pressure ⇒ page 293
- Vehicle lighting required to guarantee road safety:
 - Turn signals
 - Side lights, dipped headlights and full beam headlights
 - Rear lights
 - Brake lights
 - Rear fog light ⇒ page 97



WARNING

Not following the checklist prepared for your own safety could lead to accidents and severe injuries.

- Always follow the check list and perform the necessary operations. ■

Fuel

Introduction

You will find a factory-fitted sticker containing information on the type of fuel for your vehicle on the inside of the fuel tank flap.

Additional information and warnings:

- ⇒ Booklet Maintenance Programme
- Refuelling ⇒ page 264
- Engine and exhaust system management ⇒ page 228 ▶

 **WARNING**

Refuelling or handling fuel carelessly can cause an explosion or fire resulting in serious burns and injuries.

- Fuel is a highly explosive, easily flammable substance.
- Observe current safety instructions and local regulations concerning the handling of fuel.

Types of fuel

The type of fuel to use when refilling will depend on the vehicle's engine. You will find a factory-fitted sticker containing information on the type of fuel for your vehicle on the inside of the fuel tank flap.

SEAT recommends the use of sulphur-free or low sulphur fuel to reduce consumption and prevent engine damage.

Possible types of fuel	Alternative names	Further information
91 ^{a)} RON	Normal petrol, normal unleaded petrol	⇒ page 268
95 ^{a)} RON	Premium unleaded petrol (95 RON)	
98 ^{a)} RON	Premium unleaded petrol (98 RON)	
Diesel		⇒ page 269

^{a)} RON = Regulation Octane Number

Petrol

Petrol types

Vehicles with petrol engines must refuel using unleaded petrol according to European norm EN 228 ⇒ .

Petrol types are categorised according to their octane number (e.g. 91, 95, 98 or 99 RON (RON = "Research Octane Number"). You may use petrol with a high octane number than the one recommended for your engine. However, this has no advantage in terms of fuel consumption and engine power.

SEAT recommends refuelling with a low sulphur content or sulphur-free petrol to reduce petrol consumption for petrol engines.

Petrol additives

The quality of the fuel influences running behaviour, performance and service life of the engine. For this reason, you should use good quality petrol containing a mixture of additives. These additives will help to prevent corrosion, keep the fuel system clean and prevent deposits from building up in the engine.

If good quality petrol with additives is not available or engine problems arise, the necessary additives must be added when refuelling.

Not all petrol additives have been shown to be effective. The use of unsuitable petrol additives could damage the engine. These additives are available from qualified workshops, who will inform you of their application.

 **CAUTION**

- Only use fuel with an octane rating that is in line with the norm EN 228, otherwise significant damage could be caused to the engine and fuel system. Furthermore, it could lead to a loss of performance with the consequent engine fault.
- The use of unsuitable petrol additives could damage the engine. ▶

- If, in exceptional circumstances, petrol with a lower octane rating to that recommended is used, only use moderate engine speeds and a light throttle. Avoid using full throttle and overloading the engine. Otherwise you may damage the engine. Fill up with fuel of a suitable octane rating as soon as possible.
- Do not refuel if the filler indicates that the fuel contains metal. LRP (lead replacement petrol) fuels also contain high concentrations of metal additives. This could damage the engine!
- Just one full tank of leaded fuel would seriously impair the efficiency of the catalytic converter and could damage it.

Diesel

Diesel fuel

Diesel fuel must correspond to European standard EN 590 (In Germany, EN 590 or DIN 51628).

The use of diesel fuel with a high sulphur percentage requires shorter service intervals ⇒ Booklet Maintenance Programme ⇒ . Your qualified workshop will be able to tell you which countries have diesel with a high sulphur content.

Do not mix fuel additives (thinners, or similar additives) with diesel fuel.

Winter-grade diesel

When using “summer-grade diesel fuel”, difficulties may be experienced at temperatures below 0 °C (+32 °F) because the fuel thickens due to wax separation. For this reason, “winter-grade diesel fuel” is available in Germany, for example, during the cold months. It can be used at temperatures as low as -20 °C (-4 °F).

In countries with different climatic conditions, other types of diesel fuel are available that are suitable to local temperatures. SEAT qualified workshops and filling stations in the country concerned will inform you on the type of diesel fuels available.

A cold diesel engine makes more noise during winter temperatures than summer temperatures. Furthermore, the exhaust fumes may turn slightly bluish while the engine is heating. The quantity of exhaust gases will depend on the outside temperature.

Filter pre-heater

Vehicles with a diesel engine are fitted with a fuel filter pre-heater. This ensures that the fuel system remains operational to approx. -24 °C (-11.2 °F), provided you use winter-grade diesel which is safe to -15 °C (+5 °F).

However, if the fuel has waxed to such an extent that the engine will not start at temperatures of under -24 °C (-11.2 °F), simply place the vehicle in a warm garage or workshop for a while to heat up.

Auxiliary heater

Vehicles with a diesel engine may be fitted with an auxiliary heater. The heater runs off the fuel from the fuel tank. On doing so, smells and steam may be noticed outside the vehicle for a short period. This is normal and it is not an indication of a fault in the vehicle.

Whenever there is little fuel in the tank (reserve), the auxiliary heater automatically switches off.



WARNING

Never use start boosters. An aerosol start booster could explode or cause a sudden rise in engine speed leading to engine damage and serious injury.

**CAUTION**

- The vehicle is **not** prepared for the use of biodiesel. **Never, under any circumstances** refuel with biodiesel. It could damage the fuel system and subsequently lead to engine faults!
- The addition of biodiesel to diesel by the diesel producer according to Standard EN 590 or other equivalent (DIN 51628 in Germany, for example) is authorised and causes no type of damage to the engine or the fuel system.
- The diesel engine has been designed for to use diesel fuel exclusively. Therefore, never use petrol, fuel oil or other unsuitable fuels. The composition of these fuels may significantly damage the fuel system and the engine.
- The use of diesel fuels with a high sulphur percentage could considerably reduce the service life of the diesel particulate filter. Your qualified workshop will be able to tell you which countries have diesel with a high sulphur content.

Information on fuel consumption

The consumption and emission values indicated do not refer to one specific vehicle. They are only to be used to compare the values of the different vehicle versions. The fuel consumption and CO₂ emissions of a vehicle not only depend on the effective use of fuel. They also depend on your driving style and other non-technical factors.

Calculation of fuel consumption

Fuel consumption and emission values are determined according to the current version of the 715/2007/EC or 80/1268/EEC regulation and are valid for the vehicle kerb weight. The specifications do **not** refer to an individual vehicle. Two measuring cycles are carried out on a rolling road test bed. The test criteria are as follows:

Urban cycle	Measurement of the urban cycle starts with an engine cold start. City driving is then simulated at between 0 and 50 km/h.
Road cycle	In the road cycle simulation, the car undergoes frequent acceleration and braking in all gears, as in normal everyday driving. The road speed ranges from 0 to 120 km/h.
Combined	The average combined consumption is calculated with a weighting of around 37 % for the urban cycle and 63 % for the road cycle.
CO₂ emissions of the combination	The exhaust gases are collected during both driving cycles to calculate carbon dioxide emissions (urban and road). The gas composition is then analysed to evaluate the CO ₂ content and other emissions.

**Note**

- The kerb weight may vary according to the vehicle equipment. This could raise consumption and the CO₂ emissions slightly.
- In practice, consumption values could be different to the values calculated based on the 715/2007/EC or 80/1268/EEC regulations.

Selective Catalytic Reduction* (AdBlue)

Introduction

The AdBlue fill level must be checked when the vehicle is being serviced
⇒ Booklet Maintenance Programme.

Additional information and warnings:

- Luggage compartment ⇒ page 125
- Fuel ⇒ page 267
- Wheels and tyres ⇒ page 293
- Accessories, parts replacement, repairs and modifications ⇒ page 257

WARNING

If the AdBlue fill level is too low, the vehicle may not restart after switching the ignition off. The emergency start or jump start will not be possible either!

- Top up with AdBlue at the latest 1000 km or 600 miles before it runs out.
- Do not allow the AdBlue to run too low.

WARNING

AdBlue is an irritant, corrosive liquid that can cause injuries if it touches the skin, eyes or respiratory organs.







- If AdBlue get in contact with eyes and skin, rinse for at least 15 minutes with plenty of water and seek medical help.
- If the AdBlue is swallowed, wash the mouth with plenty of water for at least 15 minutes. Do not try to provoke vomiting unless recommended by a Doctor. Seek medical advice immediately.

CAUTION

AdBlue damages surfaces such as painted vehicle parts, plastic, items of clothing and carpets. Spilt AdBlue should be removed as quickly as possible using a damp cloth and plenty of cold water.

- If the AdBlue has crystallised, remove with warm water and a sponge. ■

Control and warning lamps

lights up	Possible cause ⇒ 	Solution
 (red)	The engine cannot be restarted! The level of AdBlue is too low.	Stop the vehicle in a suitable, safe and flat area then top up with the minimum quantity of AdBlue required ⇒ page 273.
 (red) with 	The engine cannot be restarted! AdBlue system malfunction.	Contact a specialist workshop. Have the system checked there.
 (yellow)	The AdBlue reserve is low.	Refill AdBlue over the next kilometres or miles as indicated ⇒ page 273. SEAT recommends contacting a specialist workshop.
 (red) with 	There is a fault in the AdBlue system or unsuitable AdBlue fluid has been used.	Contact a specialist workshop. Have the system checked there.

Several warning and control lamps should light up for a few seconds when the ignition is switched. This signals that the lamp is working properly. They will switch off after a few seconds. ►

 **WARNING**

If the warning lamps and messages are ignored, the vehicle may stall in traffic, or may cause accidents and severe injuries.

- **Never ignore the warning lamps or text messages.**
- **Stop the vehicle safely as soon as possible.**

 **CAUTION**

Failure to heed the warning lamps and text messages when they appear may result in faults in the vehicle.

Information on AdBlue



In vehicles with Selective Catalytic Reduction, a special urea solution (AdBlue) is injected into the exhaust gas system in front of the catalytic converter to reduce nitrogen oxide emissions.

The consumption of AdBlue depends on individual driving style, the temperature at which the system operates and the outside temperature where the vehicle is driven.

AdBlue is kept in an independent tank in the vehicle and should be refilled at an official supplier. The AdBlue tank holds about 17 litres.

A message will be displayed on the instrument panel around 2400 km before the next service to indicate that AdBlue must be refilled ⇒ page 273. If you ignore this message and do not refill, you will be unable to start the engine afterwards ⇒ page 271.

SEAT recommends contacting a specialist workshop. If you are unable to visit a qualified specialist workshop, you should temporarily refill with a minimum of 10.0 litres of AdBlue. Only refill using AdBlue expressly approved by SEAT.

When the indicators  and  light simultaneously, there is a fault. SEAT recommends visiting the closest qualified workshop.

AdBlue® is a registered trademark in the US, Germany, the European Union and other countries belonging to the German automobile industry ("Verband der Automobilindustrie e. V.", VDA).

Refilling AdBlue

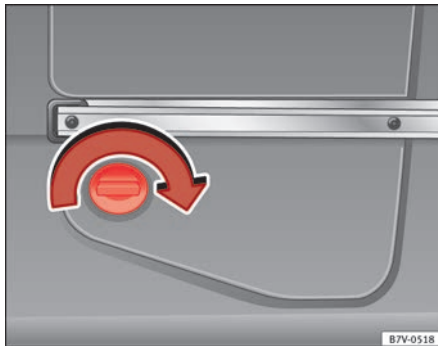

Fig. 164 At the rear left of the luggage compartment: AdBlue tank, behind a cover panel.

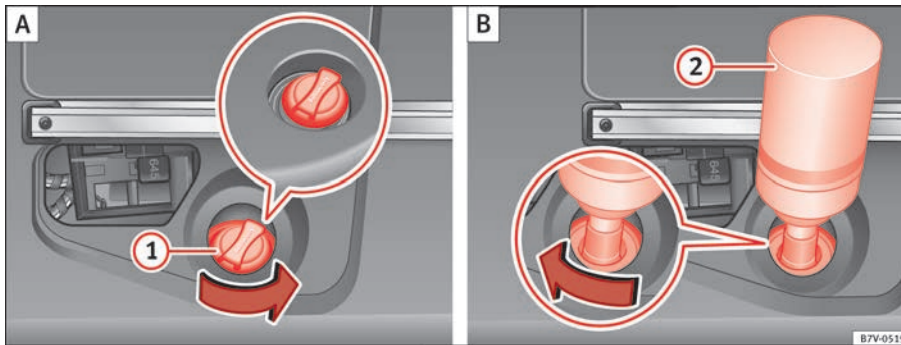

Fig. 165 AdBlue tank with filler neck cap and refilling bottle.

To refill AdBlue, the vehicle must be on flat ground and not, for example, parked on a kerb or slope. If the vehicle is not on flat ground then the filling indicator cannot measure the filling quantity. ▶

Opening the tank filling neck

- Open the tailgate.
- Rotate the shut off on the cover clockwise ⇒ fig. 164 and open the cover forwards.
- Unscrew the tank filler neck cap ⇒ fig. 165 ① anticlockwise.

Refilling AdBlue

Only use AdBlue that is approved by SEAT and that complies with the ISO 22241-1 Standard. Only use genuine bottles.

- Observe the instructions and information provided by the refill bottle manufacturer.
- Observe the expiry date.
- Unscrew the cap on the refill bottle.
- Place the refill bottle ② upside down inside the tank filler neck.
- Press the refill bottle against the filler neck and keep in this position.
- **Add at least 10 litres of AdBlue (6 bottles).** A lower quantity would be insufficient.
- Wait until the contents of the refill bottle have been poured into the AdBlue tank. Do not crush or damage the bottle!
- Unscrew the liquid bottle anticlockwise and remove it carefully ⇒ ①.
- You can tell when the AdBlue tank is full because the bottle will be empty.

Closing the tank filling neck

- Screw on the tank filler neck cap ① clockwise until it is fully inserted.
- Place the cover and turn the shut off anticlockwise to close it.

Operations before driving

- **Only** switch the ignition on after refilling.
- Keep the ignition switch on for at least 30 seconds so that the system detects tank refilling.
- Wait 30 seconds before starting the engine!

WARNING

Only keep AdBlue in its original container, tightly shut and in a safe place.

- **Never keep AdBlue in empty food cans, bottles or other containers to avoid other people mistaking it for something else.**
- **Keep the AdBlue out of the reach of small children.**

CAUTION

- Only refill using AdBlue expressly approved by SEAT. The use of any other type of AdBlue could cause engine damage!
- AdBlue should never be mixed with water or any other additives. Any type of damage caused by a mixture will not be covered by the warranty.
- Do not add AdBlue to the diesel fuel tank! Otherwise you may damage the engine.
- Never leave the refill bottle in the vehicle. It could become permeable due to temperature changes and bottle damage and the AdBlue could damage the vehicle interior.

For the sake of the environment

Dispose of the refill bottle in an environment-friendly manner.

Note

Suitable AdBlue refill bottles can be purchased from a Technical Service. ■

Working in the engine compartment

Introduction

Before working in the engine compartment, make sure that the vehicle is parked on horizontal and firm ground.

The engine compartment of the vehicle is a hazardous area. Never work on the engine or in the engine compartment if you are not familiar with the operations to be carried out, the applicable safety standards and especially if you do not have the instruments, liquids and tools necessary ⇒ ⚠! Have the work carried out by a specialised workshop if you are uncertain. Negligent work can cause serious injury.

Additional information and warnings:

- Windscreen wash system ⇒ page 105
- Start and stop the engine ⇒ page 170
- Brake fluid ⇒ page 183
- Vehicle battery ⇒ page 288
- Checks when filling up ⇒ page 264
- Engine oil ⇒ page 279
- Engine coolant ⇒ page 283
- Accessories, parts replacement, repairs and modifications ⇒ page 257



WARNING

If the vehicle moves unexpectedly, this could cause serious injury.

- Never work underneath the vehicle if it is not secured against moving. If you must work underneath the vehicle with the wheels in contact with the ground then it should be parked on flat ground, the wheels should be prevented from moving and the key must be removed from the ignition.
- If you have to work underneath the vehicle, you must use suitable stands additionally to support the vehicle, there is a risk of accident!. The jack is not intended for this kind of work and its failure could lead to severe injuries.



WARNING

The engine compartment is a dangerous area capable of causing serious injury.

- For all type of work, always take the utmost precautions, work carefully and note the general safety standards in force. Never take personal risks.
- Never work on the engine or in the engine compartment if you are not familiar with the necessary operations. If you are not sure about procedures then visit a Technical Service to carry out the necessary work. Incorrect work can cause serious injuries.
- Never open the bonnet if you see steam or coolant escaping from the engine compartment. Hot vapours and coolant can cause serious burns. Always wait until you cannot see or hear the sound of steam or coolant coming from the engine compartment.
- Always allow the engine to cool down before opening the bonnet.
- Contact with hot elements of the engine and the exhaust system can cause burns.

 **WARNING** (Continued)

- Once the engine has cooled, follow the instructions below before opening the bonnet:
 - Turn on the electronic parking brake and place the gear selector lever in P or the gear stick in neutral.
 - Remove the key from the ignition.
 - Keep children away from the engine compartment and never leave them unsupervised.
- When the engine is warm or hot, the cooling system is pressurised. Do not unscrew the cap on the expansion tank when the engine is hot. Otherwise, coolant may spray out under pressure causing burns and serious injury.
 - Carefully and slowly unscrew the cap anticlockwise, gently pressing down on it.
 - Always protect your face, hands and arms from hot coolant and steam using a large, thick cloth.
- When refilling liquids, avoid spilling them on parts of the engine and the exhaust system. Spilled liquids could cause a fire.

 **WARNING**

The high voltages of the electrical system can give electric shocks as well as causing burns and serious injury and possibly even death!

- Never cause short circuits in the electrical system. The battery could explode.
- To minimise the risk of electric shock and serious consequences while the engine is running or starting the engine, note the following:
 - Never touch the electrical wiring of the ignition system.
 - Never touch electric cables or the gas discharge lamps.

 **WARNING**

In the engine compartment, there are rotating parts that could cause serious injury.

- Never place your hands on or near the radiator fan. Touching the rotor blades could seriously harm you. The ventilator works according to the engine temperature and could start suddenly even when the ignition is turned off and the key is removed.
- If any work has to be performed when the engine is started or with the engine running, there is an additional, potentially fatal, safety risk from the rotating parts, such as the drive belts, alternator, radiator fan etc as well as from the high-voltage ignition system. Always work with the utmost caution.
 - Always make sure that no parts of your body, jewellery, ties, loose clothing and long hair can be trapped by the rotating parts of the engine. Before any work, remove ties and jewellery (necklaces, etc), tie longhair back and tie all items of loose clothing to your body to make sure that they cannot be trapped by engine components.
 - Take extreme caution when operating the accelerator and remain attentive. The vehicle could move, even with the electronic parking brake activated.
- Always make sure you have not left any objects, such as cloths or tools, in the engine compartment. If any object is left in the engine compartment, this could cause malfunctions, engine faults and even a fire.

 **WARNING**

Refill liquids and certain materials can catch fire easily in the engine compartment, causing a fire and serious injury!

- Never smoke.
- Never work close to places exposed to flames or sparks.

⚠ WARNING (Continued)

- **Never pour service fluids over the engine. These fluid may ignite hot engine parts and cause injuries.**
- **If it is necessary to work on the fuel system or the electrical system, please follow the instructions below:**
 - **Always disconnect the vehicle battery. When disconnecting the battery, ensure that the vehicle is unlocked otherwise the antitheft alarm will be triggered.**
 - **Never work close to heaters, heat sources or places exposed to flames or sparks.**
- **Always keep a recently serviced and perfectly working fire extinguisher close by.**

**CAUTION**

When refilling or changing service liquids, ensure that you put the liquids into the right tank. Making a mistake when refilling could cause serious malfunctions and damage the engine!

**For the sake of the environment**

Service fluids leaks are harmful to the environment. For this reason you should make regular checks on the ground underneath your vehicle. Take the vehicle to a specialist workshop to be checked if you see stains, oil or other fluids on the ground. Collect any spilt service fluids and allow a professional to dispose of them. ■

Preparing the vehicle for work in the engine compartment**Checklist**

Carry out the operations below in the order indicated before starting work in the engine compartment ⇒ ⚠:

- Park the vehicle on an even and solid surface.
- Press and hold the brake pedal until the vehicle comes to a standstill.
- Connect the electronic parking brake ⇒ page 183.
- Move the selector lever to its intermediate position or to **P** ⇒ page 174.
- Stop the engine and remove the key from the ignition ⇒ page 170.
- Wait for the engine to cool down.
- Always keep children and other people far from the engine compartment.
- Ensure that the vehicle can not move off unexpectedly.

**WARNING**

Ignoring this checklist, drawn up for your own safety, could result in serious injury.

- **Always complete the operations given in the checklist and observe the general rules of safety.** ■

Opening and closing the bonnet

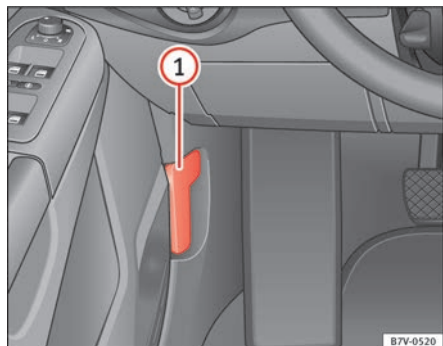

Fig. 166 In the footwell on the driver side: Lever for unlocking the bonnet.

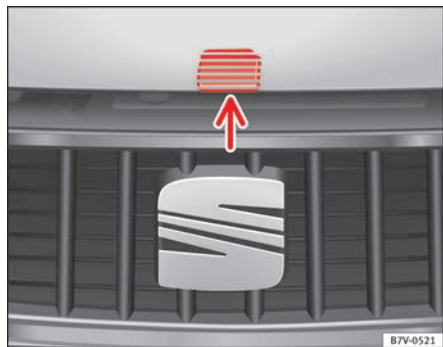

Fig. 167 Release lever to open the bonnet in the radiator grille.

Opening the bonnet

The lever to open the bonnet can only be used if the driver's door is open.

- Before opening the bonnet, make sure that the windscreen wiper arms are in place against the windscreen ⇒ ①.
- Open the driver's door.
- Pull the release lever ⇒ fig. 166 in the direction of the arrow. The bonnet is released from the lock carrier by a spring mechanism ⇒ ⚠.
- Lift the bonnet using the release lever ⇒ fig. 167 (arrow) and open the bonnet fully. The bonnet is held open thanks to the gas strut.

Closing the bonnet

- To close the bonnet, pull it down to overcome the gas strut pressure ⇒ ⚠.
- Allow the bonnet to fall into the lock carrier. *Do not press down.*

If the bonnet is not correctly closed, open it once again and close it correctly.

The bonnet is correctly closed when it is flush with the corresponding parts on the bodywork.

⚠ WARNING

If the bonnet is not correctly closed, it could suddenly open while driving leaving the driver without visibility. This could result in serious accident.

- After closing the bonnet, always check that it is properly secured by the locking mechanism in the lock carrier. The bonnet must be flush with the surrounding body panels.
- While driving, if you notice that the bonnet is not correctly closed then stop immediately and close it correctly.
- Only open and close the bonnet when there is nobody within its range.

 **CAUTION**

- To avoid damage to the bonnet and to the windscreen wiper arms, only open the bonnet when the windscreen wipers are in place against the windscreen.
- Before driving, always lower the wiper arms.

 **For the sake of the environment**

Similar to the other service liquids, spilled engine oil can be bad for the environment. Collect any spilt fluids in suitable containers and dispose of in accordance with legislation and with the utmost respect for the environment.

Engine oil

Introduction

Additional information and warnings:





- ⇒ Booklet Maintenance Programme
- Working in the engine compartment ⇒ page 275
- Accessories, parts replacement, repairs and modifications ⇒ page 257

 **WARNING**

Incorrectly handling engine oil can cause injury and serious burns.

- Always protect your eyes when handling engine oil.
- Oil is toxic and must be kept out of the reach of children.
- Engine oil must only be kept closed in its original container. The same applies to use oil until it has been disposed of.
- Never store engine oil in empty food containers or bottles as other people may accidentally drink it.
- Regular contact with engine oil can be bad for the skin. If you come into contact with engine oil, wash your skin with soap and water.
- With the engine running, the engine oil gets extremely hot and can cause severe skin burns. Always wait until the engine has fully cooled.

Warning and control lamps

lights up	Possible cause	Solution
	Insufficient engine oil.	Switch the engine off. Check the engine oil level ⇒ page 281.
flashes	Possible cause	Solution
	Engine oil pressure too low.	<p> Stop the vehicle! Switch off the engine. Check the engine oil level.</p> <p>- If the warning indicator flashes although the oil level is correct, do <i>not</i> continue driving or leave the engine running. Otherwise, the engine could be damaged. You should obtain professional assistance.</p>
	Engine oil sensor faulty.	Contact a specialist workshop. Have the engine oil sensor checked.

 **WARNING**

If the warning lamps and messages are ignored, the vehicle may stall in traffic, or may cause accidents and severe injuries.

- Never ignore the warning lamps or text messages.
- Stop the vehicle safely as soon as possible.

 **CAUTION**

Failure to heed the warning lamps and text messages when they appear may result in faults in the vehicle. ■

 **CAUTION**

- Only use engine oils whose specifications are expressly approved by SEAT. The use of any other type of engine oil could cause engine damage!
- No additives should be used with engine oil. Any damage caused by the use of such additives would not be covered by the factory warranty. ■

Engine oil specifications

Replacement engine oil must strictly comply with the specifications.

The correct oil must be used to ensure the correct operation and long service life of the engine. The engine comes with a high-quality multigrade oil that can generally be used all year round.

Only use an oil that complies to SEAT standards whenever possible ⇒ . If you wish to maintain the long-life service duration, only engine oils approved for this service according to the corresponding VW standard (⇒ table on page 280) may be used. All oils indicated are **synthetic multigrade oils**.

Engine oils are being continuously further developed. Qualified workshops are permanently informed of any modifications. SEAT therefore recommends that you have the engine oil changed by a SEAT Dealership.

Engines	Engine oil specifications	
	with LongLife service	without LongLife service
Petrol engines	VW 504 00, VW 503 00	VW 504 00, VW 502 00
Diesel engines	VW 507 00	VW 507 00

Checking the engine oil level and topping up

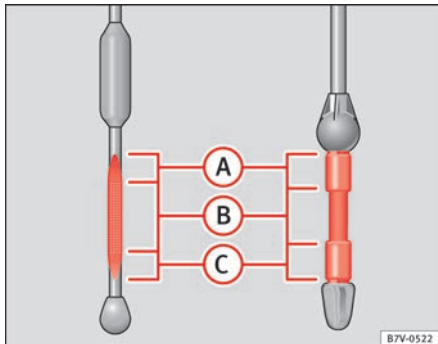

Fig. 168 Marked engine oil dipstick.

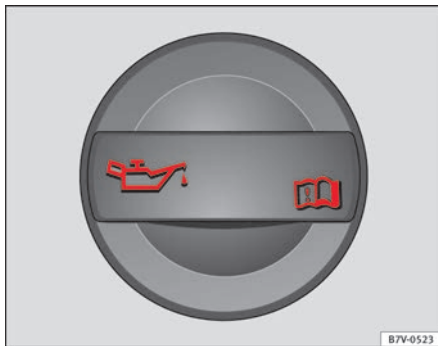



Fig. 169 In the engine compartment: Engine oil filler cap.

Preparations

- Park the vehicle on flat ground so that the engine oil reading is correct.
- Stop the engine and wait a few minutes for the oil to drain back into the sump. When the engine has cooled down, immediately check the oil level and top up if necessary.
- Open the bonnet Δ \Rightarrow page 275.
- The engine oil filler opening can be recognised by the symbol  on the cap \Rightarrow fig. 169 and the dipstick by its coloured handle.

Checking the engine oil level

- Pull out the dipstick and wipe it on a clean cloth.
- Replace the dipstick, pushing it in as far as it will go. If the dipstick has a mark, when you reintroduce it this mark should slot into the corresponding groove located on the upper end of the tube.
- Remove the dipstick again and check the engine oil level \Rightarrow table on page 281.
- After reading the oil level, replace the dipstick in the tube completely.

Engine oil topping up ranges

fig. 168	Operations required depending on the engine oil topping up level:
Area A	Do not top up oil \Rightarrow  .
Area B	Add approximately 0.5 L of oil (1/2 quarter of a gallon). The oil level can be in the zone A , but never above A .
Area C :	It is essential to add oil (approximately 1 litre or quarter of a gallon). Ensure that the level is around the centre of the zone B after adding oil.

Adding oil after checking the level

Only add engine oil in small quantities and in steps. ▶

- Unscrew the cap from engine oil filler opening on the cylinder head ⇒ **fig. 169**. If you are not sure where the cap is, request help from a specialist.
- Only refill using engine oil expressly approved by SEAT and in small quantities (not more than 0.5 l or 1/2 a quarter of a gallon at a time) ⇒ page 280.
- To avoid adding too much oil, each time you add a quantity, wait until the oil has flowed into the crankcase so that it can be measured with the dipstick.
- Check the oil level before adding any more oil. Do not top up with too much engine oil ⇒ **Ⓐ**.
- When the oil level is in at least the ⇒ **fig. 168 Ⓑ** zone, insert the dipstick into the tube fully to avoid engine oil escaping when the engine is running.
- After topping up the oil, ensure that the cap is screwed on to the filler mouth correctly.

 **WARNING**

Oil could catch fire if it comes into contact with hot engine components. This could lead to a fire, explosion and severe injuries.

- **Always ensure that after topping of oil, the engine oil filler cap is correctly tightened. This will avoid engine oil spilling onto hot engine parts when the engine is running.**

 **CAUTION**

- If the oil level is above the area **Ⓐ** do not start the engine. You should obtain professional assistance. Otherwise catalytic converter and engine damage may occur.
- When refilling or changing service liquids, ensure that you put the liquids into the right tank. Making a mistake when refilling could cause serious malfunctions and damage the engine!



For the sake of the environment

The oil level must never be above area **Ⓐ**. Otherwise oil can be drawn in through the crankcase breather and escape into the atmosphere via the exhaust system. ■

Engine oil consumption

The consumption of engine oil can be different from one engine to another and can vary during the useful life of the engine.

Depending on driving style and the conditions of use, the consumption of engine oil can reach 1 litre every 2000 km (one quarter of a gallon every 1200 miles); for new vehicles, this could be higher for the first 5000 km (3000 miles). For this reason the engine oil level must be checked at regular intervals, preferably when filling the tank and before a journey.

When the engine is working hard, for instance during sustained high-speed motorway cruising in summer, when towing a trailer or climbing mountain passes, the oil level should preferably be kept within area ⇒ **fig. 168 Ⓐ**. ■

Changing the engine oil

The engine oil must be changed regularly according to the specifications of the Maintenance Programme.

Due to the problems linked with disposing of used oil and the need for suitable tools and special knowledge, always visit a Technical Service to have the engine oil and filter changed. SEAT recommends visiting a Technical Service.

Detailed information on the service intervals are shown in the Maintenance Programme. ►

Engine oil additives make new oil darker after the engine has been running for a short period. This is normal and does not mean more frequent oil changes are required.



WARNING

If, in exceptional circumstances, you must change the engine oil yourself, please note the following:

- **Wear eye protection.**
- **Always wait until the engine has completely cooled to avoid being burned.**
- **Always keep your arms horizontal when unscrewing the oil drainage bolt so that the oil does not run down your arms when it begins to drain.**
- **Use a suitable and large enough container to collect all of the used oil in the engine.**
- **Never collect engine oil in empty food containers, cans, bottles and other containers as not all people are able to identify engine oil.**
- **Oil is toxic and must be kept out of the reach of children.**



For the sake of the environment

Before changing the engine oil, find a suitable location or service for proper disposal.



For the sake of the environment

Always dispose of engine oil with the utmost respect for the environment. Never dispose of used engine oil in places such as a garden, woods, drains, roads, paths, rivers and drainage systems. ■

Engine coolant

Introduction

Never work on the engine cooling system or if you are not familiar with the operations to be carried out, the applicable safety standards and especially if you do not have the instruments, liquids and tools necessary ⇒ ⚠! Have the work carried out by a specialised workshop if you are uncertain. SEAT recommends visiting a Technical Service.

Negligent work can cause serious injury.

Additional information and warnings:

- Towing mode ⇒ page 233
- Working in the engine compartment ⇒ page 275
- Accessories, parts replacement, repairs and modifications ⇒ page 257



WARNING

Engine coolant is toxic!

- **Only keep engine coolant in its original container, tightly shut and in a safe place.**
- **Never store engine coolant in empty food containers or bottles as other people may accidentally drink it.**
- **Always keep engine coolant out of reach of children.**
- **Ensure that the proportion of engine coolant additive corresponds to the lowest outside temperature to which the vehicle will be exposed.**
- **If the outside temperature is extremely low, the engine coolant could freeze causing the vehicle to stop. As this would also cause the heating to stop working, passengers without sufficient clothing could freeze.** ▶

For the sake of the environment

Coolants and additives can contaminate the environment. Collect any spilt fluids in suitable containers and dispose of in accordance with legislation and with the utmost respect for the environment. ■

Coolant temperature warning lamp and gauge

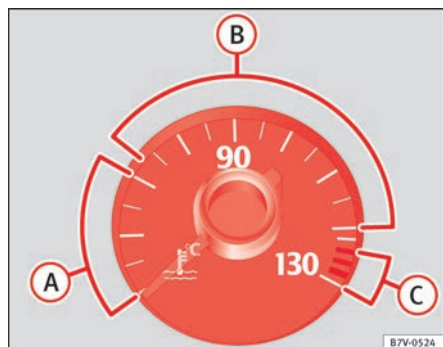





Fig. 170 Engine coolant temperature gauge on the instrument panel: (A) cold area; (B) normal area; (C) warning area.

When driving normally, the needle will remain in the middle area. The temperature may also rise when the engine is working hard, especially at high outside temperatures and so the indicator will move quite far to the right-hand side.

Several warning and control lamps should light up for a few seconds when the ignition is switched. This signals that the lamp is working properly. They will switch off after a few seconds.

lights up	Gauge position ⇒ fig. 170	Possible cause	Solution
	Warning area (C)	Excessive engine coolant temperature.	 Stop the vehicle! Stop the vehicle safely as soon as possible. Switch off the engine and wait for it to cool down and for the needle to return to the normal area. Check the engine coolant level ⇒ page 286.
	Normal area (B)	Insufficient engine coolant level.	Check the engine coolant when the engine has cooled and, if it is low, refill with engine coolant ⇒ page 286. Although the coolant level is correct, there is a fault.
	--	Engine coolant system faulty.	 Do not drive any further. Obtain professional assistance.
--	Cold area (A)	--	Avoid revving the engine too much or making it work hard while it has not reached normal service temperature.
flashes	Possible cause	Solution	
	Engine coolant system faulty.	You should obtain professional assistance. ▶	

 **WARNING**

If the warning lamps and messages are ignored, the vehicle may stall in traffic, or may cause accidents and severe injuries.

- Always observe any lit warning lamps and text messages.
- Never ignore the warning lamps or text messages.
- Stop the vehicle safely as soon as possible.

 **CAUTION**

Failure to heed the warning lamps and text messages when they appear may result in faults in the vehicle.

Engine coolant specifications

The engine cooling system comes with a special mixture of water and at least 40% **G 12 plus-plus** (TL-VW 774 G) or **G 12 plus** (TL-VW 774 F) engine coolant additive. Both are easily recognisable because they are purple in colour.

This mixture gives the necessary frost protection down to -25 °C (-13 °F) and protects the alloy parts of the cooling system against corrosion. It also prevents scaling and raises the boiling point of the coolant.

To protect the engine cooling system, the proportion of additive must *always* be at least 40%, even if frost protection is not required in countries with a warm climate.

If greater frost protection is required in very cold climates, the proportion of additive can be increased. However, the percentage of additive should not exceed 60 %, as this would reduce the frost protection and, in turn, decrease the cooling capacity.

When adding coolant, a mixture of **distilled water** and at least 40 % of the additive G 12 plus-plus must be used to ensure optimum rust protection ⇒ ⓘ.

 **WARNING**

In the event of insufficient antifreeze protection in the engine cooling system, the engine could be damaged and severe injuries caused.

- Ensure that the proportion of engine coolant additive corresponds to the lowest outside temperature to which the vehicle will be exposed.
- If the outside temperature is extremely low, the engine coolant could freeze causing the vehicle to stop. As this would also cause the heating to stop working, passengers without sufficient clothing could freeze.

 **CAUTION**

Never mix genuine additives with other additives that are not approved by SEAT. Otherwise, you run the risk of causing severe damage to the engine and the engine cooling system.

- The engine coolant G 12 plus-plus can be mixed with G 12 plus and G 11.
- If the fluid in the expansion reservoir is not purple but, for example, brown, this means that you have mixed G 12 plus-plus or G 12 plus with another coolant. The coolant must be changed as soon as possible if this is the case! Using the wrong fluids could cause serious malfunctions and engine damage!

 **For the sake of the environment**

Coolants and additives can contaminate the environment. Collect any spilt fluids in suitable containers and dispose of in accordance with legislation and with the utmost respect for the environment.

Checking the engine coolant level and refilling

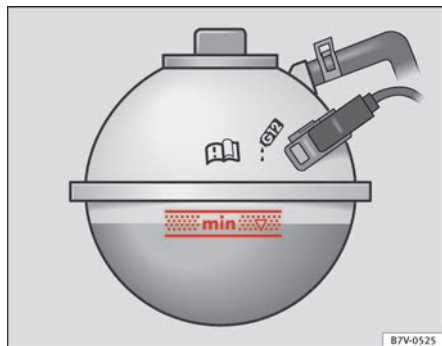





Fig. 171 In the engine compartment: Marking on coolant expansion reservoir.



Fig. 172 In the engine compartment: Coolant expansion tank cap.

If the coolant level is low, the coolant warning indicator will light.





Preparations

- Park the vehicle on even, flat and firm ground.
- Allow the engine to cool ⇒ .
- Open the bonnet  ⇒ page 275.
- The coolant expansion reservoir is easily recognisable because of the symbol  on the cap ⇒ [fig. 172](#).

Checking the engine coolant level

- When the engine is cold, check the coolant level using the side marking on the expansion reservoir ⇒ [fig. 171](#).
- If the level is below the "MIN" mark, top up with coolant. When the engine is hot it may be slightly above the marked area.

Topping up the engine coolant level

- Always protect your face, hands and arms from hot coolant and steam using a large, thick cloth over the coolant expansion tank cap.
- Remove the cap very carefully ⇒ .
- Only refill using **new** engine coolant according to SEAT specifications (⇒ page 285) ⇒ .
- The engine coolant level should be between the marks on the coolant expansion tank ⇒ [fig. 171](#). **Do not exceed the top level of the marked area** ⇒ .
- Screw on the cap tightly.
- If, the event of an emergency, you have no coolant that is compliant to the required specifications (⇒ page 285), never use another type of additive. Instead, first top up with **distilled water** ⇒  only. Then re-establish the correct proportion of the mixture with the correct additive as soon as possible ⇒ page 285.

 **WARNING**

Hot vapours and coolant can cause serious burns.

- **Never open the coolant expansion tank if steam or coolant is coming from the engine compartment. Wait until you cannot see or hear any steam or coolant escaping.**
- **Always wait until the engine has completely cooled before very carefully opening the expansion tank cap. Contact with hot elements of the engine can cause skin burns.**
- **Once the engine has cooled, follow the instructions below before opening the bonnet:**
 - Turn on the electronic parking brake and place the gear selector lever in P or the gear stick in neutral.
 - Remove the key from the ignition.
 - Keep children away from the engine compartment and never leave them unsupervised.
- **When the engine is warm or hot, the cooling system is pressurised. Do not unscrew the cap on the expansion tank when the engine is hot. Otherwise, coolant may spray out under pressure causing burns and serious injury.**
 - Carefully and slowly unscrew the cap anticlockwise, gently pressing down on it.
 - Always protect your face, hands and arms from hot coolant and steam using a large, thick cloth.
- **When refilling liquids, avoid spilling them on parts of the engine and the exhaust system. Spilled liquids could cause a fire. Under specific circumstances, the ethylene glycol can catch fire.**

 **CAUTION**

- Top up with distilled water only. Any other type of water may lead to considerable rusting in the engine due to its chemical components. This could consequently damage the engine. If you have not used distilled water but another type of water to top up the coolant, a specialist workshop must immediately replace all of the fluid in the engine cooling system.
- Only top up coolant to the top level of the marked area → fig. 171. Otherwise the excess coolant will be forced out of the cooling system when the engine is hot, causing damage.
- If a lot of liquid coolant has been lost, wait for the engine to *cool down completely* before adding coolant. Extensive coolant loss is an indication of leaks in the engine cooling system. Have the engine cooling system inspected immediately by a Technical Service. Otherwise you may damage the engine.
- When refilling or changing service liquids, ensure that you put the liquids into the right tank. Making a mistake when refilling could cause serious malfunctions and damage the engine! ■

Vehicle battery

Introduction





The battery is a component of the vehicle's electrical system.

Never work on the electrical system without fully understanding the operations required, the applicable safety standards and without the correct tools ⇒ ⚠! Have the work carried out by a specialised workshop if you are uncertain. SEAT recommends visiting a Technical Service. Negligent work can cause serious injury.

Location and number of batteries in the vehicle

The battery is located in the engine compartment.

Explanation of the warning indications on the vehicle's battery

Symbol	Meaning
	Wear eye protection!
	Battery acid is very corrosive and caustic. Always wear protective gloves and eye protection!
	Fires, sparks, open flames and smoking are prohibited.
	A highly explosive mixture of gases is released when the battery is under charge.
	Keep children away from acid and batteries!

Additional information and warnings:

- ⇒ Booklet Maintenance Programme
- Starter assist systems (Start-Stop function) ⇒ page 194
- Working in the engine compartment ⇒ page 275
- Accessories, parts replacement, repairs and modifications ⇒ page 257

WARNING

Working on the vehicle battery and the electrical system can cause corrosion, fire and electric shocks. Always read and take into account the following warnings and safety standards before carrying out any work:

- Before working on the battery, switch off the engine, the ignition and all electrical devices then disconnect the negative connection on the battery.
- Keep children away from acid and the battery itself!
- Wear eye protection.
- Battery acid is very corrosive and caustic. It can burn skin and cause blindness. When handling the battery, protect yourself from splashes of acids, above all your hands, arms and face.
- Do not smoke and never work close to places exposed to flames or sparks.
- Avoid sparks and electrostatic discharges when working with cables and electrical devices.
- Never short the battery terminals.
- Never use a damaged battery. It can explode. Replace a damaged battery immediately.
- Replaced damaged or frozen batteries as soon as possible. A flat battery can freeze at temperatures around 0 °C (+32 °F).
- For vehicles with the battery in the luggage compartment: Check that the battery gas ventilation hose is securely attached. ▶

CAUTION

- Never disconnect the battery if the ignition is switched on or if the engine is running. This could damage the electrical system or electronic components.
- Do not expose the battery to direct sunlight over a long period of time, as the intense ultraviolet radiation can damage the battery housing.
- If the car is left standing for long periods, protect the battery from extreme cold temperature so that it does not “freeze up” and become damaged.

CAUTION

Failure to heed the warning lamps and text messages when they appear may result in faults in the vehicle.

Warning lamp

lights up	Possible cause	Solution
	Faulty generator.	Contact a specialist workshop. Have the electrical system checked. Disconnect any unnecessary electrical consumers. The generator does not charge the battery while the vehicle is in motion.

Several warning and control lamps should light up for a few seconds when the ignition is switched. This signals that the lamp is working properly. They will switch off after a few seconds.

WARNING

If the warning lamps and messages are ignored, the vehicle may stall in traffic, or may cause accidents and severe injuries.

- Never ignore the warning lamps or text messages.
- Stop the vehicle safely as soon as possible.

Checking the electrolyte level of the vehicle battery

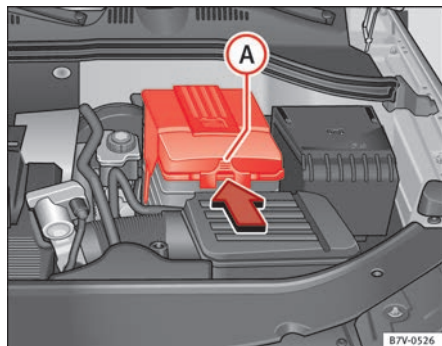

Fig. 173 In the engine compartment: Remove the cover from the vehicle's battery.

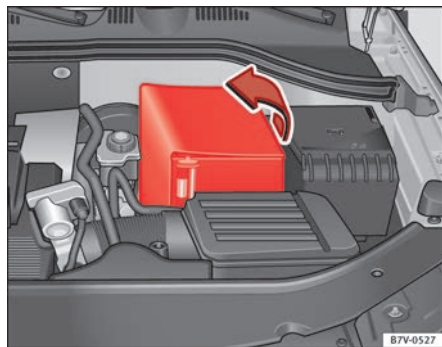

Fig. 174 In the engine compartment: Unfold the vehicle's battery hose.

The battery's electrolyte level should be checked regularly in high-mileage vehicles, in hot countries and in older batteries. Other batteries do not require maintenance.

Start-Stop systems (⇒ page 196) are equipped with a special battery labelled "AGM". For technical reasons, it is not possible to check the electrolyte level of these batteries

Preparations

- Prepare the vehicle for work in the engine compartment ⇒ page 275
- Open the bonnet Δ ⇒ page 275.

Opening the battery cover

The battery covers are different depending on the engine size of the vehicle:

- *In the case of a cover:* press the tab ⇒ fig. 173 **A** in the direction of the arrow and pull the cover upwards.
- *In the case of a hose:* fold the cover to one side to remove ⇒ fig. 174.

Checking the battery electrolyte level

- Make sure there is sufficient lighting to clearly recognise the colours. Never use open flames or sparklers as a light source.
- Depending on the level of acid, the Magic eye on the top of the battery will change colour.

Colour indicator	Necessary operations
<i>light yellow or colourless</i>	The electrolyte level of the vehicle's battery is too low. Have the battery checked and, where applicable, replaced by a specialist workshop.
<i>Black indication</i>	The electrolyte level of the vehicle's battery is correct.

WARNING

Working with the vehicle battery involves a risk of corrosion, explosions and electric shock.

- Always wear protective gloves and eye protection.

 **WARNING (Continued)**

- **Battery acid is very corrosive and caustic. It can burn skin and cause blindness. When handling the battery, protect yourself from splashes of acids, above all your hands, arms and face.**
- **Never tilt the vehicle battery. Battery acid could spill out of the openings to release gases and cause corrosion damage.**
- **Never open the vehicle battery.**
- **If battery acid splashes on you, immediately rinse your eyes and skin abundantly with water for several minutes. Then seek medical care immediately.**
- **If acid is swallowed by mistake, consult a doctor immediately.**

Charging, replacing and connecting or disconnecting the battery

Charging the battery

The vehicle battery should be charged by a specialist workshop only, as batteries using special technology have been installed and they must be charged in a controlled environment ⇒ . SEAT recommends visiting a Technical Service.

Replacing a vehicle battery

The battery has been developed to suit the conditions of its location and has special safety features. If the battery must be replaced, consult a qualified SEAT workshop for information on electromagnetic compatibility, the size and maintenance, performance and safety requirements of the new battery in your vehicle before you purchase one. SEAT recommends you have the battery replaced by a qualified SEAT workshop.

Use only maintenance-free genuine batteries conforming to TL 825 06 and VW 7 50 73 Standards. These standards must be dated April 2008 or later.

Start-Stop systems (⇒ page 196) are equipped with a special battery. Therefore, it must only be replaced with a battery of the same specifications.

Disconnecting the vehicle's battery

If you must disconnect the battery from the electrical system, please note the following:

- Switch off the ignition and all electrical equipment.
- The vehicle must be unlocked before disconnecting the battery, otherwise the alarm will be triggered.
- First disconnect the negative cable and then the positive ⇒ .

Connecting the vehicle's battery

- Before reconnecting the battery, switch off the engine, the ignition and electric devices.
- First reconnect the positive cable and then the negative ⇒ .

Different control lamps may light up after connecting the battery and switching the ignition on. They will be turned off after a short trip at a speed of between 15 - 20 km/h (10 - 12 mph). If the warning indicators remain lit, please visit a specialised workshop to have the vehicle checked.

If the battery has been disconnected for a long time, it is possible that the next service date is not displayed or calculated correctly ⇒ page 57. Respect the maximum service intervals permitted ⇒ Booklet Maintenance Programme.

Automatic consumer disconnection

The intelligent vehicle electrical system automatically implements a range of measures to prevent the battery from discharging when high demands are made on it: 

- the idling speed is increased so that the alternator provides more electricity.
- where necessary, the power of the most powerful consumers is reduced or even completely disconnected.
- On starting the engine, the power supply from the 12-volt sockets and the cigarette lighter may be interrupted for a short time.

The on-board management program cannot always prevent the battery from running flat. For example, if the ignition is left on for a long period with the engine off or if the side lights or parking lights are left on while the vehicle is stationary.

Why does the battery run flat?

- When stationary for a long time without starting the engine, particularly if the ignition is switched on.
- Use of electrical consumers with the engine switched off.
- If the auxiliary heater is running ⇒ page 163.

WARNING

Incorrectly securing the battery or using the wrong battery can cause short-circuits, fire and serious injuries.

- Always use only maintenance free batteries that do not run flat alone and whose properties, specifications and size correspond to the standard battery. The specifications are indicated on the battery case.

WARNING

A highly explosive mixture of gases is released when the battery is under charge.

- The batteries should be charged in a well-ventilated room only.
- Never charge a frozen or recently thawed battery. A flat battery can freeze at temperatures around 0 °C (+32 °F).

WARNING (Continued)

- Always replace a battery which has frozen.
- Battery cables not correctly connected may cause a short circuit. Reconnect first the positive cable and then the negative cable.

CAUTION

- Never disconnect the battery if the ignition is switched on or if the engine is running. This could damage the electrical system or electronic components.
- Never plug accessories supply current, such as solar panels or a battery charger, to the 12-volt sockets or the cigarette lighter. This could damage the vehicle's electrical system.

For the sake of the environment

- Dispose of the battery in an environment-friendly manner. Batteries contain toxic substances such as sulphuric acid and lead.
- Battery acid can contaminate the environment. Collect any spilt service fluids and allow a dispose of them correctly. ■

Wheels and tyres

Wheels

Introduction

The SEAT Alhambra is equipped as standard with anti-puncture technology tyres (Conti-Seal). In the event of a puncture or air leak of up to 5 mm, the tyre seals the hole with a protective layer inside the tread.

SEAT recommend that all work on tyres and wheels is carried out by a Technical Service. They have the necessary special tools and replacement parts, trained personnel and facilities for disposing of the old tyres. SEAT recommends visiting a Technical Service.

Additional information and warnings:

- Transporting ⇒ page 13
- Towing mode ⇒ page 233
- Braking, stopping and parking ⇒ page 183
- Park assist system ⇒ page 202
- Tyre control systems ⇒ page 221
- Caring for and cleaning the vehicle exterior ⇒ page 242
- Wheel trims ⇒ page 304
- Change wheel ⇒ page 305
- Notes for the user ⇒ page 255



WARNING

The vehicle cannot be totally controlled or braked if the tyres (new or used) are worn or damaged.

- **Incorrect use of wheels and tyres could make driving more dangerous and result in serious accidents and damage.**
- **All four wheels must be fitted with radial tyres of the same type, size (rolling circumference) and the same tread pattern.**
- **New tyres do not give maximum grip and will not have reached their maximum braking capacity to start with, and therefore need running in. To prevent accidents and major damage, extreme caution should be taken for the first 600 km (370 miles).**
- **Check tyre pressures regularly and ensure they are maintained at the pressures indicated. If the tyre pressure is too low, the tyres could over-heat, resulting in tread detachment or even burst tyres.**
- **Never drive on damaged (punctured, cut, cracked or dented) or worn tyres. Driving on damaged or worn tyres could result in burst tyres, serious accidents or damage. Worn or damaged tyres must be replaced immediately.**
- **Never exceed the maximum permitted speed or loads specified for the type of tyre fitted on your vehicle.**
- **The efficiency of driver and brake assist systems also depends on the grip of the tyres.**
- **If you notice unusual vibration or if the vehicle pulls to one side when driving, stop the car immediately and check the tyres and wheels for damage.**
- **To minimise the risk of losing control of the vehicle or causing a serious accident, never undo the bolted joints of beadlock wheels.**

⚠ WARNING (Continued)

- Never mount used tyres or wheels if you are not sure of their previous history. They may be damaged, although the damage is not immediately visible.
- Old tyres, even if they have never been used, may lose air or burst unexpectedly while driving, resulting in serious accident or damage. If tyres are over six years old, they should only be used in an emergency and with extreme caution.



Note

- For technical reasons, it is not generally possible to use the wheels from other vehicles. In some cases, this may also be true for the same model of wheel. Please refer to the vehicle documents or ask at a SEAT qualified workshop.
- If you decide to fit your vehicle with conventional tyres, remember that you must carry a puncture repair kit, not available in the tools that come with the vehicle.

About your tyres and wheels

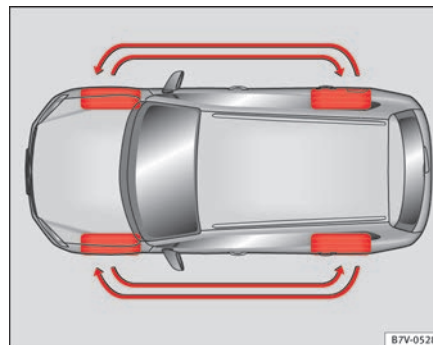

Fig. 175 Diagram for changing wheels

The tyres of a vehicle are the components which are subjected to most stress and are the most underestimated. Tyres are very important, as the support offered by their narrow surface is the only point of contact between the vehicle and the road.

The service life of tyres is dependent on tyre pressure, driving style, the care they receive and the correct fitting.

The tyres and wheel rims are an essential part of the vehicle's design. The tyres and rims approved by SEAT are specially matched to the characteristics of the vehicle and our critical to good road holding and safe handling.

Avoiding damage to tyres and wheels

- If you have to drive over a kerb or similar obstacle, drive very slowly and as near as possible at a right angle to the kerb.
- Inspect the tyres regularly for damage (punctures, cuts, cracks, dents).
- Remove any foreign bodies found on the outside of the tread provided **they have not passed through the wall of the tyre** ⇒ page 299.
- The instructions for tyre control systems should always be observed. ▶

- Replace damaged or worn tyres as soon as possible ⇒ page 299.
- Regularly check tyres for non-visible damage ⇒ page 299.
- Never exceed the maximum permitted speed or loads specified for the type of tyre fitted on your vehicle ⇒ page 302.
- Do not allow tyres to come into contact with aggressive substances, grease, oil, fuel or brake fluid ⇒ .
- Lost valve caps should be replaced immediately.

Tyres with directional tread pattern

Tyres with directional tread pattern have been designed to operate best when rotating in only one direction. An arrow on the tyre sidewall indicates the direction of rotation on tyres with directional tread ⇒ page 302. Always observe the direction of rotation indicated when mounting the wheel. This guarantees optimum grip and helps to avoid aquaplaning, excessive noise and wear.

If the tyre is mounted in the opposite direction of rotation, drive with extreme caution, as the tyre is no longer being used correctly. This is of particular importance when the road surface is wet. Change the tyre as soon as possible or remount it with the correct direction of rotation.

Interchanging tyres

To ensure that the wear is equal on all tyres the wheels should be changed round from time to time according to the system ⇒ fig. 175. All the tyres will then last for about the same time.

SEAT recommends you take the vehicle to a Technical Service to have the tyres changed.

Tyres that are over 6 years old

Tyres are subject to an ageing process as a result of physical and chemical processes. This may affect their performance. Tyres which are stored for long periods of time without being used, harden and become more fragile than tyres which are in constant use.

SEAT recommends that tyres over six years old are replaced with new tyres. This also applies to tyres which appear to be in perfect condition on the out-

side and which have a tread depth within the values stipulated by the Law ⇒ .

The date of manufacture, part of the tyre identification number (TIN), indicates the age of the tyre ⇒ page 302.

Storing tyres

Mark tyres when you remove them to indicate the direction of rotation (left, right, forwards, backwards). This ensures you will be able to mount them correctly when you replace them. When removed, the wheels and/or tyres should be stored in a cool, dry and preferably dark location. Do **not** place tyres mounted on the wheel in a vertical position.

Protect tyres not mounted on wheels from dirt by storing them in suitable bags and standing them on the ground on their tread.



WARNING

Aggressive fluids or substances could result in visible or invisible damage with the consequent risks.

- Always ensure that tyres do not come into contact with chemical products, oil, grease, fuel, brake fluid or other aggressive substances.



WARNING

Old tyres, even if they have never been used, may lose air or burst unexpectedly while driving, resulting in serious accident or damage.

- If tyres are over six years old, they should only be used in an emergency and with extreme caution.



For the sake of the environment

Old tyres must be disposed of by qualified personnel according to the laws in the country concerned. ■

Wheel rims

The design of wheel bolts is matched to the rims. If different rims are fitted, the correct wheel bolts with the right length and correctly shaped bolt heads must be used. This ensures that wheels are fitted securely and that the brake system functions correctly ⇒ page 305.

For technical reasons, it is not generally possible to use the wheels from other vehicles. In some cases, this may also be true for the same model of wheel.

The tyres and rims approved by SEAT are specially matched to the characteristics of the vehicle and are critical to good road holding and safe handling.

Wheel bolts

Wheel bolts must be tightened to the correct torque ⇒ page 305.

Beadlock wheel rims

Beadlock wheel rims have various components. These are joined together by special bolts using a special procedure. This ensures good performance, a better seal, improved safety and wheel run out. Therefore, worn rims should always be replaced and must only be repaired in a Technical Service. SEAT recommends visiting a Technical Service ⇒ ⚠.

Wheel rims with bolted trims

Wheel rims may be fitted with interchangeable trim parts which are attached to the rim using self-locking bolts. Worn trims should only be replaced at a Technical Service. SEAT recommends visiting a Technical Service ⇒ ⚠.

WARNING

The use of worn or damaged wheel rims could make driving more dangerous and result in serious accidents and damage.

- Only wheel rims which have been approved for use with your vehicle should be used.
- Inspect wheel rims regularly for damage and replace as required.

WARNING

If the bolted joints of wheel rims with bolted ring trims are not correctly tightened or loosened, this could result in serious accident.

- Never loosen the bolted joints of wheel rims with bolted ring trims.
- Any work relating to wheel rims with bolted rims should be carried out at qualified workshop. SEAT recommends visiting a Technical Service. ■

Replacement of new tyres and wheel rims

New tyres

- When tyres are new, drive with extreme caution for the first 500 km (310 miles), as all tyres need to be *run-in*. Tyres which have not been run-in do not have such good grip ⇒ ⚠ or braking capacity ⇒ ⚠.
- All four wheels must be fitted with radial tyres of the same type, size (rolling circumference) and the same tread pattern.
- The tread depth of new tyres may vary, according to the type and make of tyre and the tread pattern.

Replacing tyres

- Where possible, always replace both wheels on an axle (both wheels on the front axle or both wheels on the rear axle) ⇒ ⚠.
- Old tyres should only be replaced by SEAT approved tyres for the vehicle in question, and in accordance with the maximum permitted size, diameter, load and speed capacity.
- Never use tyres which are larger than SEAT approved tyres. If the tyres are too big, they may knock or rub against the chassis or other components, resulting in damage. ▶

WARNING

New tyres do not give maximum grip and will not have reached their maximum braking capacity to start with, and therefore need running in.

- To prevent accidents and major damage, extreme caution should be taken for the first 600 km (370 miles).

WARNING

There should be adequate space between the tyres and the vehicle in accordance with the vehicle design. If this is not the case, the tyres may rub against parts of the running gear, chassis or brake lines, leading to faults in the brake system or to tread detachment, and the risk of burst tyres.

- The true tyre dimension should not be greater than the dimensions of tyres manufactured and approved by SEAT and should not rub against parts of the vehicle.

Note

- Although tyres may be shown as being the same size, the true dimensions of different types of tyre may vary with respect to the nominal size, or tread patterns may be different.
- If you use tyres that are approved by SEAT, you can be sure that the true tyre dimensions will be correct for your vehicle. For other tyre models, the tyre vendor should provide the manufacturer's certificate with the tyre, indicating that this type of tyre is suitable for your vehicle. This certificate should always be carried with the vehicle.

Tyre pressures

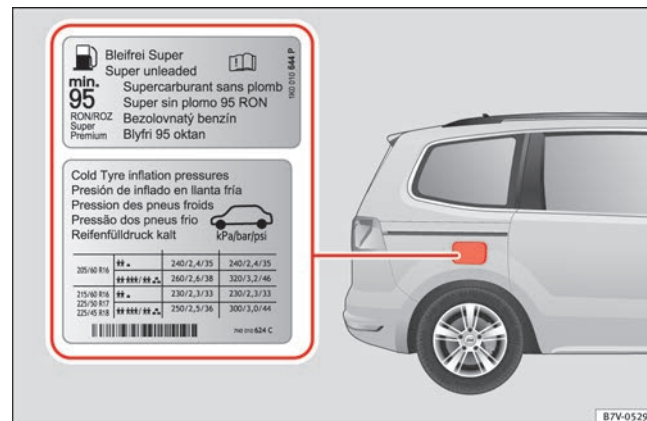



Fig. 176 Position of tyre pressure specification plate.

The correct tyre pressures for tyres fitted at the factory is shown on a label and is valid for summer and winter tyres. This label ⇒ fig. 176 is either in the driver's door strut or inside the fuel cap.

Under-inflation or over-inflation will reduce the life of the tyres considerably and also impair the car's handling ⇒ . It is essential to maintain the correct tyre pressures, especially if driving at **high speeds**. Incorrect tyre pressure causes premature wear and could cause tyre blow-out.

The pressure should therefore be checked at least once a month and before starting a journey.

As a general rule, the pressures given are for **cold tyres**. When the tyres are hot, the pressures are greater.

Never deflate a hot tyre in order to obtain the required pressure. This could result in very low tyre pressures which may lead to sudden blow-outs.

Checking tyre pressures

Tyre pressures should only be checked when the vehicle has not been driven for more than a few kilometres (miles) at low speeds in the past three hours.

- The tyre pressures should be checked regularly, and only when the tyres are cold. Always check all the tyres. Tyre pressures should be checked more often in colder regions, and only when the vehicle has not been driven recently. Always use a correctly-operating tyre gauge.
- Adjust tyre pressures to the loads carried in the vehicle.
- After checking the pressure, always replace the valve caps, and where applicable, observe the instructions given for adjusting the tyre control system ⇒ page 221.

WARNING

If tyre pressures are too high or too low, the tyre may deflate or burst suddenly while driving. This could result in serious accident.

- If the tyre pressure is too low, the tyres could overheat, resulting in tread detachment or even burst tyres.
- When driving at high speeds and/or fully loaded, the tyre could suddenly overheat, burst or be subject to tread detachment, with the resultant loss of control of the vehicle.
- Tyre pressures which are too high or too low reduce the service life of the tyre, affecting the vehicle's performance.
- Tyre pressures should be checked regularly, at least once a month and before long journeys.
- Adjust the pressures of all the tyres to the vehicle load.
- Never deflate excess pressure from hot tyres.

CAUTION

- Take care not to tilt the manometer when placing it on the valve. Otherwise, the valve may be damaged.
- To avoid damage to the valves, always replace valve caps correctly. Check that the caps are identical to the standard caps and have been correctly tightened.

For the sake of the environment

Under-inflated tyres will increase the fuel consumption.

Note

When checking tyre pressures, please observe the instructions for the tyre control system ⇒ page 221. ■

Tread depth and wear indicators

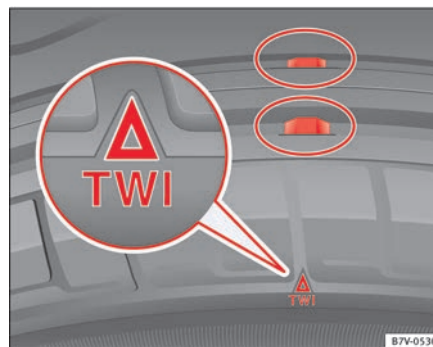



Fig. 177 Tyre tread: tread wear indicators. ►

Tread depth

Certain driving conditions require a deeper tread, as well as needing the tread to be approximately the same on the front and rear tyres. This is particularly important when driving in winter, in cold temperatures and on wet roads ⇒ .

The minimum tread depth required by law in the majority of cases is 1.6 mm (1/16 of an inch), measured in the tread grooves next to the tread wear indicators. Observe legal requirements in each country.

The performance of **winter tyres** is much reduced when the tread has worn to 4 mm (5/32 inch).

The tread depth of new tyres may vary, according to the type and make of tyre and the tread pattern.

Wear indicators on the tyre

The original tyres on your vehicle have 1.6 mm (1/16 inch) high ⇒ [fig. 177](#) tread wear indicators running across the tread. A number of these indicators are equally spaced around the tyre tread. Certain marks on the tyre walls (for example, the letters “TWI” or other symbols) indicate the position of the wear indicators.

Tread wear indicators indicate if a tyre is worn. Tyres must always be replaced before the tyre tread has worn to the level of the indicator.



WARNING

Driving with worn tyres is dangerous, and may lead to loss of control of the vehicle with serious consequences.

- Tyres must be replaced before the wear indicators are at the same level as the tread pattern.



WARNING (Continued)

- Worn tyres have significantly reduced grip, especially on wet surfaces, increasing the risk of “aquaplaning”.
- Worn tyres make control of the vehicle more difficult in normal or difficult driving conditions, increasing the braking distance and the risk of skidding.

Damaged tyres

Damage to wheels and tyres is often not immediately visible. If you notice unusual **vibration** or the car **pulling to one side**, this may indicate that one of the tyres is damaged ⇒ .

- Slow down immediately if you think you have a damaged wheel.
- Check the wheels and tyres for damage.
- If tyres are worn, stop driving and seek qualified assistance.
- If there is no visible exterior damage, drive slowly and carefully to the nearest qualified workshop and have the vehicle checked.

Foreign bodies in the tyre

- Do not remove foreign bodies if they have penetrated through the tyre wall!
- You should obtain professional assistance immediately.

The sealant at the lower part of the tyre tread wraps around the foreign body and provisionally seals the tyre.

Wear of tyres

The wear of tyres depends on a number of factors, for example:

- Driving style.
- Unbalanced wheels.
- Running gear settings.

Driving style: driving round bends fast or sudden acceleration or braking speed up the wear of tyres. When the driving style is normal, if the tyres wear too quickly, have the running gear settings checked at a Technical Service.

Wheel run-out: The wheels on new vehicles are balanced. However, certain circumstances may lead to imbalance (run-out), which is detected as vibrations in the steering wheel. Run-out leads to wear of the steering and suspension. In the event of run out, the wheels should be balanced again. When a new wheel is fitted, it should be balanced again.

Running gear settings: an incorrectly positioned running gear increases the wear of tyres and affects your safety while driving. If tyres wear too quickly, have the wheel alignment checked at a specialist workshop.

WARNING

If you notice unusual vibration or the car pulls to one side while driving, this may indicate that one of the tyres is damaged.

- Reduce speed immediately and stop, while observing the highway code.
- Check the wheels and tyres for damage.
- Never carry on driving on worn tyres or wheels. Request qualified assistance immediately.
- If there is no visible exterior damage, drive slowly and carefully to the nearest qualified workshop and have the vehicle checked.

Winter tyres*

In winter conditions winter tyres will considerably improve the vehicle's handling. The design of summer tyres (width, rubber compound, tread pattern) gives less grip on ice and snow. Winter tyres also improve the vehicle braking performance, reducing the braking distance in winter weather. SEAT rec-

ommend that winter tyres be fitted to the vehicle at temperatures below +7 °C (+45 °F).

The performance of winter tyres is much reduced if the **tyre tread** is worn below 4 mm (1/16 inch). The **age** of the tyre is another factor affecting performance, regardless of the depth of the tyre tread.

Please observe the following when using winter tyres:

- Observe legal requirements in each country.
- Winter tyres must be fitted on all four wheels.
- Only use winter tyres in wintery weather conditions.
- Only use winter tyres of the size authorised for the vehicle.
- Only use radial winter tyres of the same type, size (rolling circumference) and tread pattern.
- Adjust speeds to within the limits indicated (code letter on tyre) ⇒ .

Speed limit

A code letter indicating the speed limit is stamped on all winter tyres ⇒ page 303.

In some vehicles, it is possible to set a speed warning in the **MFA (multifunction indicator)** menu on the instrument panel ⇒ page 62.

If you use **V-rated tyres** the speed limits and tyre pressure will be determined by engine size. Please ask your SEAT qualified workshop for further information on the maximum permitted speed and the required pressures for the tyres.

All-wheel drive*

Thanks to its all-wheel drive, your car will have plenty of traction in winter conditions, even with the standard tyres. Nevertheless, SEAT still recommend that winter tyres or all-season tyres should be fitted *on all four wheels* when winter road conditions are expected, mainly because this will give a better *braking response*. ▶

Please observe all instructions and warnings when using **snow chains**
⇒ page 301.



WARNING

Although winter tyres help to make driving safer in the winter, you should not take unnecessary risks.

- **Adjust your speed and driving style to visibility, road, traffic and weather conditions.**
- **Never exceed the maximum permitted speed or loads specified for the type of winter tyre fitted on your vehicle.**



For the sake of the environment

When winter is over, change back to summer tyres. In temperatures above +7 °C (+45 °F), performance will be improved if summer tyres are used. Fuel consumption, wear and noises while driving will all be reduced.



Note

- If the vehicle is fitted with a tyre control system, this should be “reprogrammed” whenever a tyre is changed ⇒ page 223.
- Please ask at SEAT qualified workshops for information about the permitted sizes for winter tyres.

Snow chains

When using snow chains, applicable local legislation and maximum permitted speed limits must be observed.

In winter weather, snow chains not only help to improve grip but also improve the braking capacity.

Snow chains must only be mounted **on the front wheels**, even on **all-wheel drive** vehicles, and only with the tyre and rim combinations listed below:

Tyre size	Wheel rim
205/60 R16	6 1/2 J x 16 ET 33

SEAT recommends you ask a SEAT qualified workshop for further information on wheel, tyre and chain sizes.

Wherever possible use fine-link chains measuring less than 15 mm (3/4 inch) including the lock.

Remove wheel hub covers and trim rings before fitting snow chains ⇒ ④. The wheel bolts should be covered with caps for safety reasons. These are available from qualified workshops.



WARNING

The use of unsuitable or incorrectly fitted chains could lead to serious accidents and damage.

- **Always the appropriate snow chains.**
- **Observe the fitting instructions provided by the snow chain manufacturer.**
- **Never exceed the maximum permitted speeds when driving with snow chains.**



CAUTION

- Remove the snow chains to drive on roads without snow. Otherwise they will impair handling, damage the tyres and wear out very quickly.
- Wheel rims may be damaged or scratched if the chains come into direct contact with them. SEAT recommends the use of covered snow chains.



Note

Snow chains are available in different sizes according to the vehicle type.

Tyre code

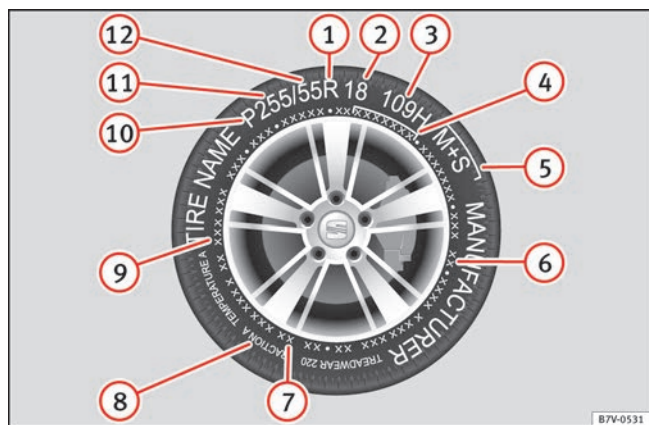



Fig. 178 Universal code on tyres.

- ① Radial
- ② Rim diameter code
- ③ Load index & speed rating
- ④ DOT tyre identification number
- ⑤ Severe snow conditions
- ⑥ Tyre ply composition and materials used
- ⑦ Max. load rating
- ⑧ Treadwear, traction and temperature grades
- ⑨ Max. permissible inflation pressure
- ⑩ Passenger car tyre
- ⑪ Nominal width of tyre in millimetres
- ⑫ Ratio of height to width (aspect ratio)

Tyre code (example)	Meaning										
<i>Make, logotype</i>	<i>Manufacturer</i>										
<i>Product name</i>	Name of tyre assigned by manufacturer.										
P215 / 55 R 16	Size: <table border="1"> <tr> <td>P</td> <td>Passenger vehicle code.</td> </tr> <tr> <td>215</td> <td>Nominal width between walls, in mm.</td> </tr> <tr> <td>55</td> <td>Height/width ratio in %</td> </tr> <tr> <td>R</td> <td>Tyre type (R indicates "radial").</td> </tr> <tr> <td>16</td> <td>Rim diameter in inches</td> </tr> </table>	P	Passenger vehicle code.	215	Nominal width between walls, in mm.	55	Height/width ratio in %	R	Tyre type (R indicates "radial").	16	Rim diameter in inches
P	Passenger vehicle code.										
215	Nominal width between walls, in mm.										
55	Height/width ratio in %										
R	Tyre type (R indicates "radial").										
16	Rim diameter in inches										
91 V	Load index ⇒ page 303 and speed rating ⇒ page 303.										
XL	Reinforced tyres.										
M+S or M/S	Winter tyres (mud and snow tyres) ⇒ page 300.										
SSR or DSST, Eufonia, RFT, ROF, RSC, ZP, 	Specific manufacturer codes for run-flat tyres.										
RADIAL TUBELESS	Radial tyre without inner tube.										
E4 ...	E-mark certifying tyre complies with international legislation followed by a number denoting the country granting the authorisation. The authorisation number (several digits) is shown below.										
DOT BT RA TY5 1709	Tyre identification number (TIN ^a , may be only on interior wall of wheel) and date of manufacture: <table border="1"> <tr> <td>DOT</td> <td>The tyre complies with the legal requirements of the US Department of Transport, responsible for tyre safety regulations.</td> </tr> <tr> <td>BT</td> <td>Place of manufacture code.</td> </tr> <tr> <td>RA</td> <td>Information about manufacturer and tyre size.</td> </tr> <tr> <td>TY5</td> <td>Manufacturer's tyre specifications.</td> </tr> <tr> <td>1709</td> <td>Date of manufacture: Week 17 of 2009. ▶</td> </tr> </table>	DOT	The tyre complies with the legal requirements of the US Department of Transport, responsible for tyre safety regulations.	BT	Place of manufacture code.	RA	Information about manufacturer and tyre size.	TY5	Manufacturer's tyre specifications.	1709	Date of manufacture: Week 17 of 2009. ▶
DOT	The tyre complies with the legal requirements of the US Department of Transport, responsible for tyre safety regulations.										
BT	Place of manufacture code.										
RA	Information about manufacturer and tyre size.										
TY5	Manufacturer's tyre specifications.										
1709	Date of manufacture: Week 17 of 2009. ▶										

Tyre code (example)	Meaning
TWI	This identifies the position of the Tread Wear Indicator ⇒ page 298.
MAX LOAD 615 KG (1356 LBS)	US load rating, indicating maximum permitted load per tyre.
MAX INFLATION 350 KPA (51 PSI)	US limit, indicating maximum permitted tyre pressure.
SIDEWALL 1 PLY RAYON	Information about tyre wall components: 1 layer of rayon (artificial silk).
TREAD 4 PLIES 1 RAYON + 2 STEEL + 1 NYLON	Information about tread components: In the example, there are 4 layers below the tread: 1 layer of rayon (artificial silk), 2 layers of steel reinforcement and 1 layer of nylon.
Information for the end consumer concerning the comparative values of the established base tyres (standardised test procedures):	
TREADWEAR 280	Relative service life of the tyre, with respect to specific US standard test.
TRACTION AA	Braking capacity of tyre on wet surface (AA, A, B or C).
TEMPERATURE A	Tyre temperature resistance at higher test speeds (A, B or C).
If there are different letters, they are specific codes of the tyre manufacturer or specific national codes.	

^{a)} The letters TIN refer to the tyre serial number.

Tyres with directional tread pattern

Tyres with directional tread pattern have been designed to operate best when rotating in only one direction. An arrow on the tyre sidewall indicates the direction of rotation on tyres with directional tread. Always observe the direction of rotation indicated when mounting the wheel. This guarantees optimum grip and helps to avoid aquaplaning, excessive noise and wear.

Tyre load rating

The load rating code indicates the maximum load in kilogrammes each wheel can carry (load capacity).

91	615 kg (1356 pounds)
93	650 kg (1433 pounds)
95	690 kg (1521 pounds)
97	730 kg (1609 pounds)
99	775 kg (1709 pounds)

Speed rating

The speed rating indicates the maximum speed permitted for the tyres.

P	max. 150 km/h (93 mph)
Q	max. 160 km/h (99 mph)
R	max. 170 km/h (106 mph)
S	max. 180 km/h (112 mph)
T	max. 190 km/h (118 mph)
U	max. 200 km/h (124 mph)
H	max. 210 km/h (130 mph)
V	max. 240 km/h (149 mph)
Z	max. 240 km/h (149 mph)
W	max. 270 km/h (168 mph)
Y	max. 300 km/h (186 mph)

Some manufacturers use the letters “ZR” for tyres with a maximum authorised speed above 240 km/h (149 miles). ■

Wheel trims*

Introduction

Additional information and warnings:

- Caring for and cleaning the vehicle exterior ⇒ page 242
- Change wheel ⇒ page 305
- Vehicle tools ⇒ page 320

WARNING

If the wheel trims are not appropriate or not fitted correctly, they could cause major accidents or damage.

- Incorrectly mounted wheel trims may come off while driving and endanger other road users.
- Damaged trims must never be mounted on the wheels.
- Always ensure that the brake ventilation and cooling is not cut off or blocked. This is also valid if hubcaps are fitted later. If there is not enough air, you may require significantly longer braking distances.

CAUTION

Remove and remount wheel trims taking care to avoid damage to the vehicle.

Full hubcaps*

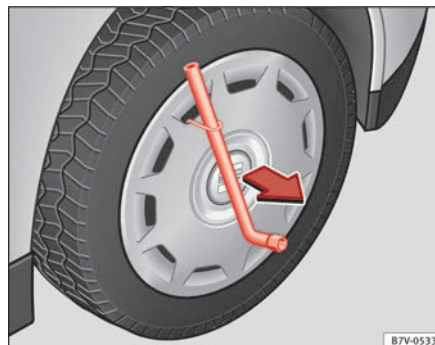

Fig. 179 Removing the full hubcap.

Removing the full hubcap

- Take the wheel brace and the wire hook from the vehicle tool kit ⇒ page 320.
- Hook the wire through one of the grooves on the hubcap.
- Insert the wheel brace onto the wire hook ⇒ fig. 179 and pull the hubcap in the direction shown by the arrow.

Fitting hubcaps

Before mounting the full hubcap, the anti-theft wheel lock must be threaded into position ⇒ fig. 182 ② or ③. Otherwise it will not be possible to mount the full hubcap.

Press the hubcap against the wheel so that the space for the valve fits over the tyre valve ⇒ fig. 182 ①. Make sure that the hubcap is correctly fitted all the way around the wheel.

Wheel bolt caps



Fig. 180 Removing the wheel bolt caps

- Take the wire hook from the vehicle tool kit ⇒ page 320.
- Insert the wire hook in the cap through the opening ⇒ fig. 180 and pull outwards in the direction of the arrow.

The caps protect the wheel bolts and should be remounted after changing the tyre.

The **anti-theft wheel locking bolt** has a special cap. This cap only fits on anti-theft locking bolts and is not for use with standard wheel bolts. ■

Changing a wheel*

Introduction

The tyres mounted on the vehicle are anti-puncture. The wheels should only be changed when switching from summer to winter tyres or vice-versa. See ⇒ page 299

You should only change the wheels yourself if the vehicle is parked in a safe place, you are familiar with the procedure and you have all the necessary tools! Otherwise, you should seek professional assistance.

Additional information and warnings:

- Vehicle key set ⇒ page 71
- Wheels and tyres ⇒ page 293
- Wheel trims ⇒ page 304
- Vehicle tools ⇒ page 320



WARNING

Changing a wheel can be dangerous, especially on the hard shoulder. Please observe the following rules to minimise the risk of injury:

- **Stop the vehicle safely as soon as possible. Park your vehicle as safe distance from surrounding traffic to change a wheel.**
- **When changing a wheel, keep all passengers and particularly children a safe distance away from the work area.**
- **Turn on the hazard warning lights to warn other road users.**
- **Ensure the ground on which you park is flat and solid. If necessary, support the jack on a wide solid base.**
- **If you are changing a wheel yourself, you should be familiar with the required procedure. Otherwise, you should seek professional assistance.** ►

 **WARNING** (Continued)

- Only use suitable tools that are not damaged when changing a wheel.
- Always stop the engine, turn on the electronic parking brake and place the gear selector lever in position P, for an automatic gearbox, or engage a gear for a manual gearbox to reduce the risk of the vehicle moving accidentally.
- Have the tightening torque of the wheel bolts checked as soon as possible with a reliable torque wrench.

 **WARNING**

Failure to follow the checklist prepared for your own safety could lead to accidents and severe injuries.

- Always complete the operations given in the checklist and observe the general rules of safety.

Preparations for changing a wheel

Check list

Before changing a wheel, complete the following operations in the order given ⇒ :

1. Park the vehicle on an even and solid surface.
2. Connect the electronic parking brake ⇒ page 183.
3. Automatic gearbox: Move selector lever to position **P** ⇒ page 174.
4. Stop the engine and remove the key from the ignition ⇒ page 170.
5. Manual gearbox: Select a gear ⇒ page 174.
6. Have all vehicle occupants get out of the vehicle and wait in a safe place (for example, behind the safety barrier).
7. Block the opposite wheel with wedges or a similar object.
8. When towing a trailer: unhook the trailer from the towing vehicle and park it correctly.
9. If the luggage compartment is full: take the baggage out of the vehicle.
10. Take the vehicle tool kit out of the luggage compartment.
11. Remove the wheel trims ⇒ page 304.

Wheel bolts

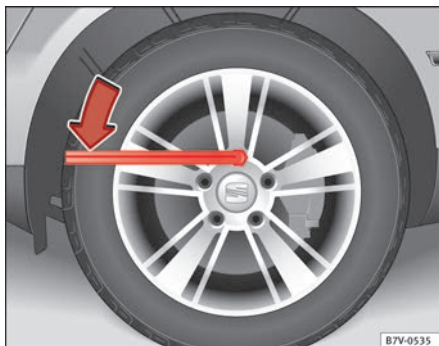

Fig. 181 Changing the wheel: Slacken the wheel bolts.

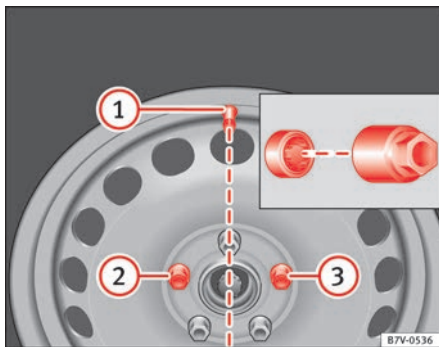

Fig. 182 Changing the wheel: Tyre valve (1) and position of anti-theft wheel locking bolt (2) or (3).

Only use the tool supplied with the vehicle to loosen the wheel bolts.

Loosen the wheel bolts only about one turn before raising the vehicle with the jack.

If the wheel bolt is very tight, you may be able to loosen it by pushing down on the end of the wheel brace carefully with your foot. Hold on to the car for support and take care not to slip.

Loosening wheel bolts

- Fit the wheel brace as far as it will go over the wheel bolt ⇒ **fig. 181**.
- Hold the wheel brace at the end and rotate the bolt approximately *one* turn anticlockwise ⇒ **⚠**.

Loosening anti-theft wheel bolts

For wheels with full hubcap, the anti-theft wheel lock must be threaded into position ⇒ **fig. 182** (2) or (3) before mounting the hubcap. Otherwise it will not be possible to mount the full hubcap.

- Take the adapter for anti-theft wheel bolts out of the vehicle tool kit.
- Insert the adapter onto the wheel bolt.
- Fit the wheel brace onto the adapter as far as possible.
- Hold the wheel brace at the end and rotate the bolt approximately *one* turn anticlockwise ⇒ **⚠**.

Important information about wheel bolts

The wheel rims and bolts have been designed to be fitted to factory options. If different rims are fitted, the correct wheel bolts with the right length and correctly shaped bolt heads must be used. This ensures that wheels are fitted securely and that the brake system functions correctly.

In some circumstances, wheel bolts from the same model vehicle should not be used.

Wheel bolt tightening torque

The prescribed tightening torque for wheel bolts for steel and alloy wheels is **140 Nm**. Have the tightening torque of the wheel bolts checked as soon as possible with a reliable torque wrench.

If wheel bolts are rusty and it is difficult to tighten them, the threads should be replaced and cleaned **before checking the torque**. ▶

Never grease or lubricate wheel bolts or the wheel hub threads. Although they have been tightened to the prescribed torque, they could come loose while driving.

**WARNING**

If the wheel bolts are not fitted correctly they could be released while driving leading to loss of vehicle control and serious damage.

- Only use wheel bolts which correspond to the wheel rims in question.
- Never use different wheel bolts.
- The bolts and threads should be clean, free of oil and grease and easy to thread.

**WARNING (Continued)**

- To loosen and tighten the wheel bolts, always use the wheel brace supplied with the vehicle.
- Loosen the wheel bolts only about one turn before raising the vehicle with the jack.
- Never grease or lubricate wheel bolts or the wheel hub threads. Although they have been tightened to the prescribed torque, they could come loose while driving.
- Never loosen the bolted joints of wheel rims with bolted ring trims.
- If the wheel bolts are not tightened to the correct torque, they may come loose while driving, and the bolts and rims may come out. If the tightening torque is too high, the wheel bolts and threads can be damaged.

Raising the vehicle with the jack

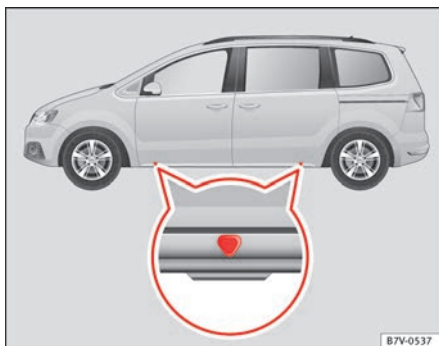

Fig. 183 Jack position points

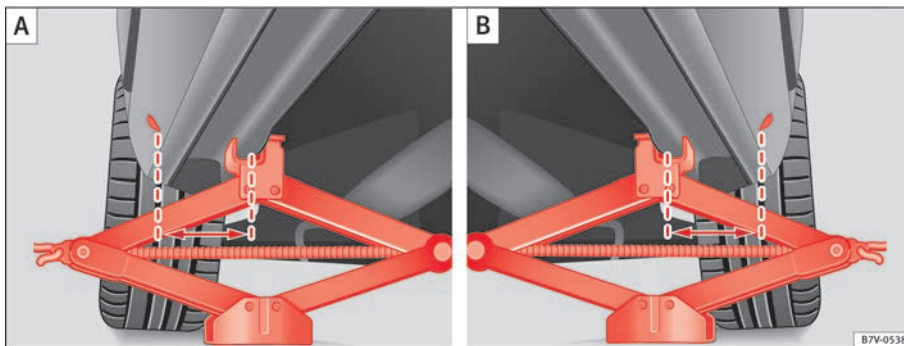

Fig. 184 (A): jack mounted on the left front part of the vehicle (B): jack mounted on the left rear part of the vehicle.

The jack may be applied only at the jacking points shown (marks on chassis) ⇒ fig. 183. The mark indicates the jacking points **below** the vehicle. The jacking points are on the ribs **behind** the front edges ⇒ fig. 184. Always the relevant jacking point for the wheel to be changed ⇒ ⚠.

Raise the vehicle using only the designated jacking points. ▶

Check list

For your own safety and that of other passengers, the following points should be observed in the order given ⇒ ⚠:

1. Select a suitable flat and firm surface for raising the vehicle.
2. Switch off the engine, engage a gear (manual gearbox) or place the selector lever in position **P** ⇒ page 174 and turn on the electronic parking brake ⇒ page 183.
3. When towing a trailer: unhook the trailer from the towing vehicle and park it correctly.
4. Loosen the wheel bolts on the wheel to be changed ⇒ page 307.
5. Look below the vehicle for the jacking point ⇒ fig. 183 closest to the tyre which has to be changed.
6. Raise the jack with the handle until it can be inserted below the jacking point.
7. Ensure that the foot of the jack is firmly on the ground and that it is placed immediately below the lifting point on the vehicle ⇒ fig. 184.
8. Straighten the jack and continue raising it using the handle until the claw holds the vertical reinforcement beneath the vehicle ⇒ fig. 184.
9. Raise the vehicle until the wheel is clear of the ground.

WARNING

If the vehicle is not correctly raised, it could fall off the jack causing serious injury. Please observe the following rules to minimise the risk of injury:

- You should only use a jack approved by SEAT for your vehicle. Other jacks, even those approved for other SEAT models, might slip out of place.
- The ground should be firm and flat. If the ground is sloped or soft then the vehicle could slip and fall off the jack. If necessary, support the jack on a wide solid base.

WARNING (Continued)

- If the ground is slippery (for example, on tiles), place a non-slip surface (for example a floor mat) beneath the jack to avoid slipping.
- Only fit the jack at the prescribed jacking points. The claw of the jack should grip the reinforcement nerve on the underbody ⇒ fig. 184.
- You should never have any limbs beneath a raised vehicle which is only supported by a jack.
- If you have to work underneath the vehicle, you must use suitable stands additionally to support the vehicle, there is a risk of accident!
- Never raise the vehicle if it is tilting to one side or the engine is running.
- Never start the engine when the vehicle is raised. The vehicle may come loose from the jack due to the engine vibrations.

WARNING

Failure to follow the checklist prepared for your own safety could lead to accidents and severe injuries.

- Always complete the operations given in the checklist and observe the general rules of safety.

Changing a wheel



Fig. 185 Changing the wheel: loosen wheel bolts with the socket at the end of the wheel brace.

Removing the wheel

- Please observe the check list ⇒ page 306.
- Loosen the wheel bolts ⇒ page 307.
- Jacking up the vehicle ⇒ page 309.
- Using the hexagonal socket in the wheel brace ⇒ **fig. 185**, unscrew the slackened wheel bolts and place them on a clean surface.
- Take off the wheel.

Putting on the spare wheel

Check the direction of rotation of the tyre ⇒ page 295.

- Fit the wheel.
- Screw on the anti-theft locking bolt with the adapter in position ⇒ **fig. 182** ② or ③ clockwise and tighten gently.
- Replace the other wheel bolts and tighten *slightly* using the hexagonal socket on the end of the wheel brace.
- Lower the car with the jack.

- Tighten all of the wheel bolts clockwise ⇒ **⚠**. Tighten the bolts in diagonal pairs (not in a circle).
- Put the caps, trim or full hubcap back on ⇒ page 304.

⚠ WARNING

If the wheel bolts are not treated suitably or not tightened to the correct torque then this could lead to loss of vehicle control and to a serious accident.

- All the wheel bolts and hub threads should be clean and free of oil and grease. The wheel bolts should be easily tightened to the correct torque.
- The hexagonal socket in the wheel brace should be used for turning wheel bolts only. Do not use it to loosen or tighten the wheel bolts.

After changing the wheel

- Clean the wheel brace, if necessary and put it away in the luggage compartment ⇒ page 320.
- Have the tightening torque of the wheel bolts checked as soon as possible with a torque wrench ⇒ page 307.

i Note

If the vehicle is fitted with a tyre monitoring system, this should be “reprogrammed” if necessary whenever a tyre is changed ⇒ page 223.

If and when

In case of emergency

Introduction

Additional information and warnings:

- Braking, stopping and parking ⇒ page 183
- Emergency locking and unlocking ⇒ page 314
- Vehicle tools ⇒ page 320

WARNING

A faulty vehicle in traffic represents a risk of accident for the driver and for other road users.

- Stop the vehicle safely as soon as possible. Park the vehicle a safe distance from surrounding traffic to lock all the doors in case of an emergency. Turn on the hazard warning lights to warn other road users.
- Never leave children or disabled people alone in the vehicle if the doors are to be locked. In case of an emergency, passengers will be trapped inside the vehicle. Individuals locked in the vehicle can be exposed to very high or very low temperatures.

Protecting yourself and securing the vehicle





Fig. 186 In the centre of the instrument panel: Switch for hazard warning lights.

Always fulfil legal requirements for securing a broken down vehicle. In a number of countries it is now obligatory, for example, to turn on the hazard warning lights and use a reflective safety vest ⇒ page 314.

When being towed with the hazard warning lights on, a change in direction or traffic lane can be indicated as usual using the turn indicator lever. The hazard lights will be interrupted temporarily.

Checklist

For your own safety and that of other passengers, the following points should be observed in the order given ⇒ :

1. Park the vehicle a safe distance from traffic and on suitable ground ⇒ .
2. Turn on the hazard warning lights with the button  ⇒ fig. 186.
3. Connect the electronic parking brake ⇒ page 183.

4. Move the selector lever to its intermediate position or to **P** ⇒ page 174.
5. Stop the engine and remove the key from the ignition ⇒ page 170.
6. Have all occupants leave the vehicle and move to safety, for example behind a guard rail.
7. When leaving the vehicle, take all keys with you.
8. Place an emergency warning triangle to indicate the position of your vehicle to other road users.
9. Allow the engine to cool and check if a specialist is required.

Examples of when to use the hazard warning lights:

- If the vehicles ahead suddenly slow down or reach the end of a traffic jam, to warn the vehicles behind.
- In case of an emergency.
- If the vehicle breaks down.
- When being towed.

Always comply with the applicable laws regarding the use of hazard warning lights.

If the hazard warning lights are not working, you must use an alternative method of drawing attention to your vehicle. This method must comply with traffic legislation.

WARNING

Failure to follow the checklist prepared for your own safety could lead to accidents and severe injuries.

- **Always complete the operations given in the checklist and observe the general rules of safety.**



WARNING

The components of the exhaust system reach very high temperatures. This could cause a fire and considerable damage.

- **Always park your vehicle so that no part of the exhaust system can come in contact with flammable materials (such as dried grass or fuel).**



Note

- The vehicle battery will discharge and run down if the hazard warning lights remain on for too much time (even with the ignition turned off).
- For some vehicles, the brake lights will blink when braking suddenly at speeds of approximately 80 km/h to warn vehicles behind. If braking continues, then the hazard warning lights will automatically be turned on at the speed of less than approximately 10 km an hour. The brake lights remain lit. Upon accelerating, the hazard warning lights will be automatically turned off.

First aid kit, warning triangle, reflective vests and fire extinguishers*

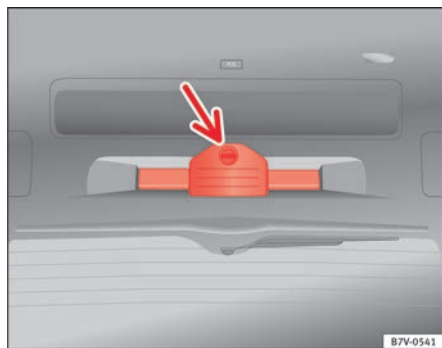

Fig. 187 On the boot lid:
Warning triangle bracket.

Reflective vests

Some vehicles will have a driver's door compartment to store a reflective vest ⇒ page 53.

Warning triangle

With the tailgate open, rotate the lock ⇒ fig. 187 90°. Lower the bracket and remove the warning triangle.

First-aid kit

There is a **first aid kit** ⇒ page 141 in the rear left-hand side storage compartment of the luggage compartment.

The first aid kit must comply with legal requirements. Check the expiry date of the contents of the first aid kit.

Fire extinguisher

There is a **Fire extinguisher** underneath the passenger seat.

The fire extinguisher must conform to legal requirements, be ready for use and be checked regularly. Check the certification seal on the extinguisher.

WARNING

Loose objects in the passenger compartment can be violently thrown in case of a sudden manoeuvre or braking and especially in accidents causing serious injury.

- Secure fire extinguishers, first aid kit, reflective vests and warning triangle securely to their respective supports.

Emergency locking and unlocking

Introduction

The doors, tailgate and panoramic sliding roof can be locked manually and partially opened, for example if the key or the central locking is damaged.

Additional information and warnings:

- Vehicle key set ⇒ page 71
- Central locking and locking system ⇒ page 74
- Doors ⇒ page 80
- Tailgate ⇒ page 84
- Panorama sliding sunroof ⇒ page 92
- In case of emergency ⇒ page 312

! WARNING

Opening and closing doors carelessly can cause serious injury.

- If the vehicle is locked from outside, the doors and windows cannot be opened from the inside.
- Never leave children or disabled people alone in the car. They could be trapped in the car in an emergency and will not be able to get themselves to safety.
- Depending on the time of the year, temperatures inside a locked and closed vehicle can be extremely high or extremely low resulting in serious injuries and illness or even death, particularly for young children.

! WARNING

Getting in the way of the doors and the panoramic sliding roof is dangerous and can lead to serious injury.

- Open and close the doors and the panoramic sliding roof only when nobody is in the way.

! CAUTION

When opening and closing in an emergency, carefully disassemble components and then reassemble them carefully to avoid damage to the vehicle. ■

Manually locking and unlocking the driver's door

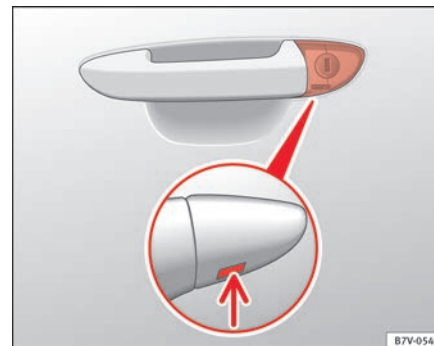

Fig. 188 Driver's door handle: Hidden lock cylinder.

In general, when the driver's door is locked all other doors are locked. Unlocking manually only opens the driver's door. Please note the instructions for the antitheft alarm ⇒ page 74.

- Unfold the key shaft ⇒ page 71.
- Insert the key shaft into the opening in the cover on the driver's door handle from below ⇒ fig. 188 (arrow) then remove the cover upwards.
- Insert the key shaft into the lock cylinder to unlock or lock the vehicle.

Unlocking notes:

- The antitheft alarm will remain active when vehicles are unlocked. However, the alarm will not yet be triggered ⇒ page 74.
- If the driver's door is opened, the alarm will be triggered.
- Switch the ignition on. When the ignition is switched on, the electronic immobiliser recognises a valid vehicle key and deactivates the anti-theft alarm system.

**Note**

The antitheft alarm is not activated when the vehicle is locked manually using the key ⇒ page 74. ■

Locking the passenger side door and sliding doors manually



Fig. 189 To the front of the passenger side door: Emergency lock, hidden by a rubber cap.



Fig. 190 Emergency locking of the vehicle using the vehicle key.

The passenger side door and the sliding doors can be locked manually. The antitheft alarm is **not** activated in this case.

- Door open.
- Remove the rubber cap to the front of the door. The rubber cap is marked with a lock symbol  ⇒ fig. 189.
- Unfold the key shaft ⇒ page 71.
- Insert the key shaft horizontally into the opening and moved the colour lever forwards ⇒ fig. 190.
- Replace the rubber cap and close the door.
- Check if the door is locked.
- Carry out the same operation on the other doors if necessary.
- Have the vehicle checked by a Technical Service.

**Note**

The doors can be opened and unlocked individually from the inside by pulling the inside door handle. To open, pull the inner door release lever twice ⇒ page 74. ■

Emergency unlocking the tailgate

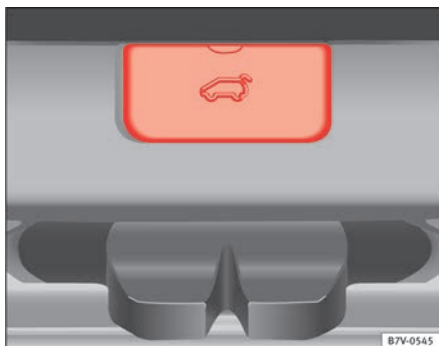

Fig. 191 From the luggage compartment: Remove the tailgate cover.

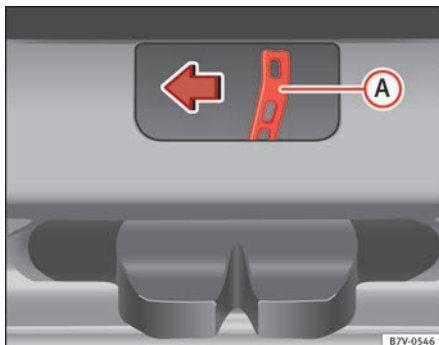

Fig. 192 From the luggage compartment: Manually unlocking the tailgate.

- Push the release lever ⇒ fig. 192 **A** in the direction of the arrow to unlock the tailgate.
- Manually open the tailgate. ■

- Remove equipment to access the inside of the tailgate.
- Remove the square cover in the inner trim of the tailgate ⇒ fig. 191.

Manually closing the panoramic sliding roof

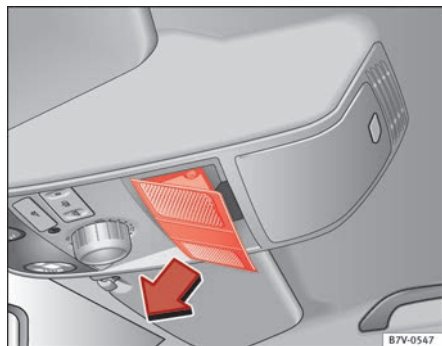

Fig. 193 On the interior roof lining: Remove cover.

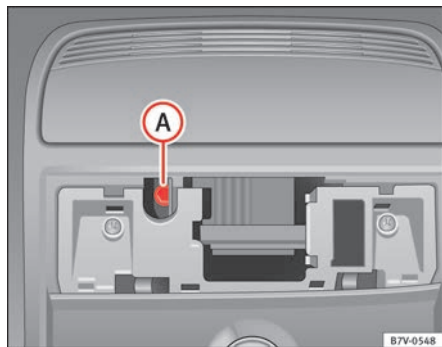

Fig. 194 Allen bolt to close the panoramic sliding roof.

- Push open the cover in the direction indicated (arrow) ⇒ fig. 193.
- Insert a standard 4 mm Allen key¹⁾ into the Allen bolt ⇒ fig. 194 **A**.
- Rotate the Allen bolt to close the panoramic sliding roof.
- Re-install the lining.
- Bring the vehicle to a specialist workshop to check the panoramic sliding roof given that the emergency closing operation could damage general operation or the anti-trap function of the panoramic sliding roof. ■

¹⁾ Not included with the on-board tools.

Manually unlocking the gear selection lever

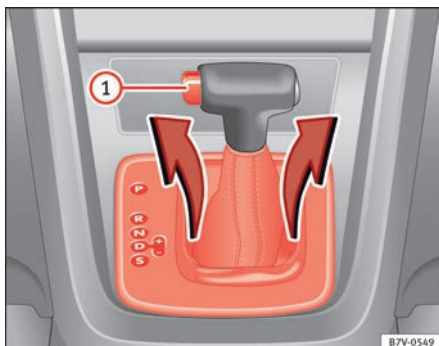

Fig. 195 Remove the lining from the area of the gear indication.

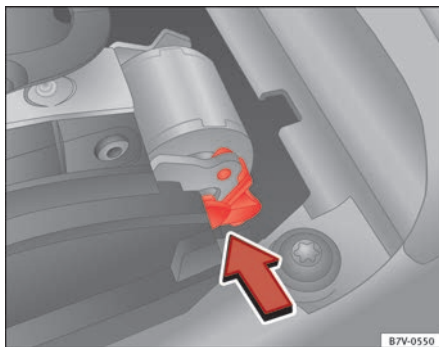

Fig. 196 Manual release of gear selector lever.

If the vehicle power supply should ever fail (discharged battery, etc.) and the vehicle has to be pushed or towed, the selector lever must first be moved to position **N** using the manual release mechanism.

The emergency release mechanism is located underneath the gearbox cover panel to the right-hand side. To release the gear selector lever mechanism, a suitable tool is required, for example a screwdriver.

Preparations

- Apply the parking brake. If the parking brake cannot be activated in the vehicle must be secured otherwise so that it cannot move.
- Switch the ignition off.

To remove the gearbox cover panel

- Pull the cover up around the dust guard on the gear selector lever ⇒ fig. 195.
- Take the cover off by passing it over the gear selector lever ⇒ ⚠.

Manual release of selector lever

- Press the release lever ⇒ fig. 196 in the direction of the arrow and hold it in this position.
- Press the lock button ⇒ fig. 195 ① on the gear selector lever knob and place the gear selector lever in the **N** position.



WARNING

Never move the gear selector lever from the position **P** while the electronic parking brake is deactivated. Otherwise, the vehicle may accidentally move off on hills or steep slopes causing serious accidents.



CAUTION

If the vehicle is moved on its wheels with the engine stopped and the selector lever in position **N** for a prolonged period of time and at high speed, for example for towing, then the automatic gearbox will be damaged. ■

Tools*

Introduction

When securing the vehicle in case of a breakdown, please note the legal requirements for each country.

Additional information and warnings:

- Working in the engine compartment ⇒ page 275
- Change wheel ⇒ page 305
- In case of emergency ⇒ page 312

WARNING

Loose objects in the passenger compartment can be violently fired through the compartment in case of a sudden manoeuvre or braking and especially in accidents causing serious injury.

- Make sure that the vehicle tools are stored safely in the luggage compartment.

WARNING

Unsuitable or damaged on-board tools can cause injury or accidents.

- Never work with inappropriate or damaged tools.

Location

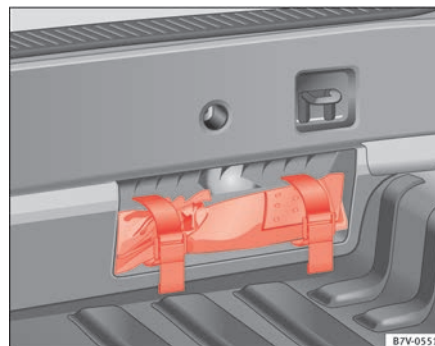

Fig. 197 In the luggage compartment, viewed from inside the vehicle: On-board tools are located in a cavity close to the lock carrier.

Depending on the model, the vehicle tools may be kept in the luggage compartment, in a cavity close to the lock carrier ⇒ fig. 197. Loosen the safety straps and remove the on-board tools. For vehicles factory-fitted with winter tyres, you will find additional tools in a toolbox located in the luggage compartment.

Note

After use, return the jack to its initial position using the handle in order to securely store it in the vehicle.

Components

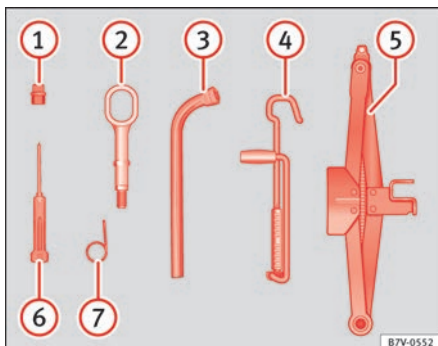

Fig. 198 Components of the onboard toolkit.

The set of on-board tools depends on the vehicle equipment. The following is a description for a vehicle with all options.

The individual elements of the on-board toolkit ⇒ fig. 198

- ① Adapter for anti-theft bolt. SEAT recommend you carry the wheel bolt adapter in the vehicle tool kit at all times. The **code number** of the anti-theft wheel bolt is stamped on the front of the adapter. In case it is lost, another adapter can be ordered using this number. Note the anti-theft bolt code for the wheels and keep it in a place other than the vehicle.
- ② Towing eye, removable.
- ③ Wheel spanner.
- ④ Jack. Fold the jack before returning it to the toolkit.
- ⑤ Jack. Before storing the jack in the toolkit, fold its hook.
- ⑥ Screwdriver with hexagon socket in the handle for screwing and unscrewing the wheel bolts once loosened. The screwdriver bit is inter-

changeable. The screwdriver may be found underneath the wheel spanner.

- ⑦ Wire hook for pulling off the wheel cover, integral hubcaps and the wheel bolt caps. ■

Fuses

Introduction

Due to the constant update of vehicles, fuse assignments depending on equipment and the use of the same fuse for various electrical components, at the time of printing this manual it is not possible to provide an up-to-date summary of the electrical components fuse positions. For detailed information about the fuse positions, please consult a Technical Service.

In general, a fuse can be assigned to various electrical components. Likewise, an electrical component can be protected by several fuses.

Only replace fuses when the cause of the problem has been solved. If a newly inserted fuse blows after a short time, you must have the electrical system checked by a qualified dealership as soon as possible.

Additional information and warnings:

- Working in the engine compartment ⇒ page 275

WARNING

The high voltages in the electrical system can give serious electrical shocks, causing burns and even death!

- **Never touch the electrical wiring of the ignition system.**
- **Take care not to cause short circuits in the electrical system.**

WARNING

Using unsuitable fuses, repairing fuses or bridging a current circuit without fuses can cause a fire and serious injury.

- **Never use a fuse with a higher value. Only replace fuses with a fuse of the same amperage (same colour and markings) and size.**
- **Never repair a fuse.**
- **Never replace a fuse by a metal strip, staple or similar.**

CAUTION

- To avoid damage to the vehicles electric system, before replacing a fuse turn off the ignition, the lights and all electrical elements and remove the keys from the ignition.
- If you replace a fuse with higher-rating fuse, you could cause damage to another part of the electrical system.
- Protect the fuse boxes when open to avoid the entry of dust or humidity. Dirt and humidity inside fuse boxes can cause damage to the electrical system.

Note

- One single consumer could have more than one fuse.
- Several consumers could run over one single fuse. ■

Vehicle fuses

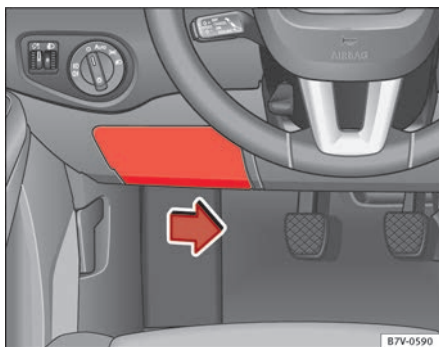

Fig. 199 On the driver-side dashboard: fuse box cover.

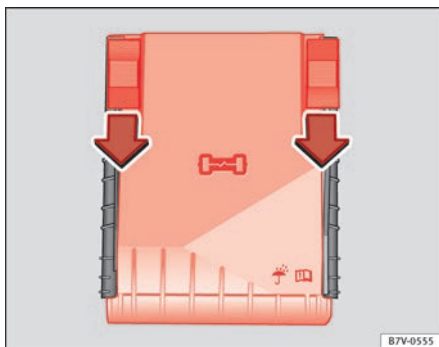

Fig. 200 In the engine compartment: fuse box cover.

Only replace fuses with a fuse of the same amperage (same colour and markings) and size.

Identifying fuses by colours

Colour	Amp rating
purple	3
light brown	5
Brown	7.5
Red	10
Blue	15
Yellow	20
White or transparent	25
Green	30
orange	40

To open the dashboard fuse box

- To remove the cover, move the activation lever in the lower part to the right ⇒ [fig. 199](#).
- For right-hand drive vehicles, move the lever to the left.

To open the engine compartment fuse box

- Open the bonnet  ⇒ [page 275](#).
- Move the attachment tabs forwards, in the direction indicated by the arrow to release the fuse box cover ⇒ [fig. 200](#).
- Then lift the cover out.
- To **fit** the cover, place it on the fuse box. Push the attachment tabs back, in the opposite direction indicated by the arrow until they click audibly into place.

It is possible that there are more fuses behind a cover in the lower left-hand side of the luggage compartment. ►

! CAUTION

- Always carefully remove the fuse box covers and refit them correctly to avoid problems with your vehicle.
- Protect the fuse boxes when open to avoid the entry of dust or humidity. Dirt and humidity inside fuse boxes can cause damage to the electrical system.

i Note

In the vehicle, there are more fuses than those indicated in this chapter. These should only be changed by a specialist workshop.

Replacing a blown fuse

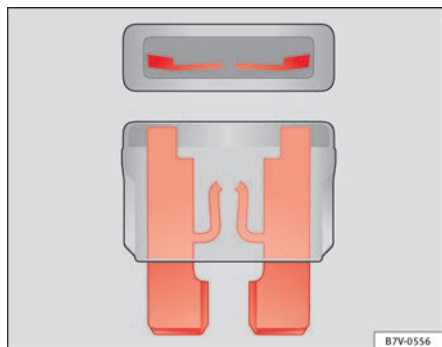

Fig. 201 Image of a blown fuse.

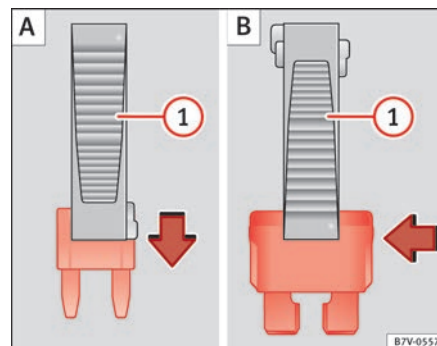

Fig. 202 Removing or fitting a fuse.

Preparation

- Switch off the ignition, lights and all electrical equipment.
- Open the corresponding fuse box ⇒ page 323

Identifying a blown fuse

A fuse is blown if its metal strip is ruptured ⇒ fig. 201.

Point a lamp at the fuse. This will make it easier to see if the fuse is blown.

To replace a fuse

- If necessary, remove the plastic pincers from the fuse box cover.
- For *small fuses*, insert the pincers from above ⇒ fig. 202 (A).
- For *larger fuses*, insert the pincers from one side of the fuse (B).
- Remove the relevant fuse.
- Replace the blown fuse by one with an *identical* amperage rating (same colour and markings) and *identical* size ⇒ ①.
- Replace the cover.

**CAUTION**

If you replace a fuse with higher-rating fuse, you could cause damage to another part of the electrical system. ■

Changing bulbs

Introduction

Changing bulbs requires a certain amount of manual skill. If you are unsure, SEAT recommends that you consult a qualified workshop or request assistance from a specialist. In general, a specialist is required if other vehicle components must be removed or if the discharge lamps must be replaced.

You should store spare light bulbs in the vehicle for safety-relevant lights. Spare bulbs may be obtained from the Official dealers and workshops. In some countries, it is a legal requirement to carry spare bulbs in the vehicle.

Driving with faults and blown bulbs on the vehicle exterior lighting is against the law.

Additional bulb specifications

The specifications of some headlamp bulbs and bulbs for the tail lamps fitted at the factory may be different to those of conventional bulbs. Bulb information is displayed on the bulb socket or on the bulb itself.

Additional information and warnings:

- Lights and visibility ⇒ page 95
- Working in the engine compartment ⇒ page 275
- Vehicle tools ⇒ page 320
- Fuses ⇒ page 322



WARNING

If the road is not well-lit and the vehicle is not clearly visible to other drivers, there is a risk of accident.



WARNING

Failure to replace bulbs correctly may cause serious accidents.

- Before carrying out any work in the engine compartment please read and observe the warnings ⇒ page 275. In any vehicle, the engine compartment is a hazardous area and could cause severe injury.
- Discharge lamps work with high-voltage and can cause serious or fatal injury if handled incorrectly.
- H7 and discharge lamps are highly pressurised and could explode when being changed.
- Only replace the bulbs concerned when they have cooled.
- Never replace bulbs alone if you are not familiar with the operations necessary. If you are not sure about procedures then visit a Technical Service to carry out the necessary work.
- Never touch the bulb glass directly. Fingerprints will be evaporated by the heat of the operating bulb thus “fogging” up the reflector.
- The headlamp frameworks in the engine compartment and the tail lamps contain sharp elements. Always protect your hands when changing bulbs.



CAUTION

After changing a bulb, if the rubber covers and plastic caps are not replaced correctly on the headlamp framework, the electrical installation may be damaged, especially if water is allowed to enter.

Indicator

lights up	Possible cause	Solution
	A vehicle exterior lighting bulb is not working.	Replace the faulty bulb.

Several warning and control lamps should light up for a few seconds when the ignition is switched. This signals that the lamp is working properly. They will switch off after a few seconds.

Checking the bulbs of a trailer

For vehicles with the factory fitted trailer system, certain trailer lights are also controlled if the socket is correctly connected.

A fault on a trailer turn indicator is indicated on the instrument panel by the indicator blinking twice as fast (↔ or ↔) ⇒ page 95.

- General fault of all indicators on one side.
- Fault in one tail light (on some models, also the registration light).
- Fault in two brake lights.



WARNING

If the warning lamps and messages are ignored, the vehicle may stall in traffic, or may cause accidents and severe injuries.

- **Never ignore the warning lamps or text messages.**
- **Stop the vehicle safely as soon as possible.**



CAUTION

Failure to heed the warning lamps and text messages when they appear may result in faults in the vehicle.





Note

A fault in the LED on the tail lights will not be indicated. However, if the fault affects all the LEDs then this will be indicated by the indicator . ■

Information for replacing bulbs

Checklist

To replace a bulb, carry out the following operations always in the order given ⇒ :

1. Park the vehicle a safe distance from traffic and on suitable ground.
2. Connect the electronic parking brake ⇒ page 183.
3. Turn the light switch to position **0** ⇒ page 95.
4. Move the gear lever into the neutral position ⇒ page 95.
5. Automatic gearbox: Move selector lever to position **P** ⇒ page 174.
6. Stop the engine and remove the key from the ignition ⇒ page 170.
7. Manual gearbox: Select a gear ⇒ page 174.
8. Wait until all of the passenger compartment lights are turned off ⇒ page 95.
9. Allow the corresponding bulb to cool.
10. Visually inspect fuses to see if any are blown ⇒ page 322.
11. Replace the bulb according to the instructions ⇒ . Bulbs should only be replaced by new identical models. Bulb information is displayed on the bulb socket or on the bulb itself.
12. In general, never touch the bulb glass directly. The heat of the bulb would cause the fingerprint to evaporate and condense on the reflector. This will impair the brightness of the headlight.
13. Check if the new bulb is working. If the bulb is not working, it may not have been correctly fitted, it could be damaged or the connector may not be correctly connected.
14. Every time a bulb for the headlights is replaced, visit a specialised workshop to check the headlights. ►

⚠ WARNING

Failure to follow the checklist prepared for your own safety could lead to accidents and severe injuries.

- Always complete the operations given in the checklist and observe the general rules of safety.

⚠ CAUTION

Always remove and fit headlights carefully to avoid damage to the paintwork and other vehicle parts.

To replace halogen headlight bulbs

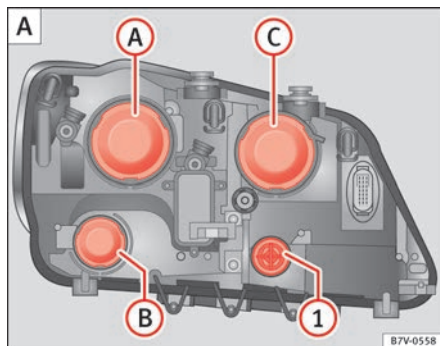

Fig. 203 In the engine compartment: Left-hand side headlight lining. (A) dipped beam headlights, (B) daytime lights and (C) main beam headlights and side lights.

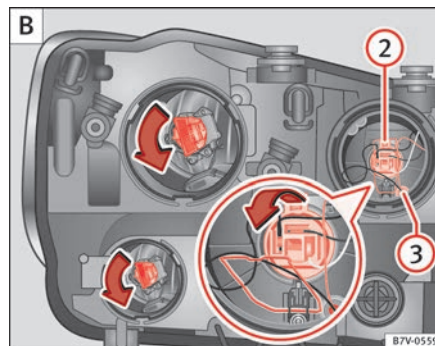

Fig. 204 Left headlight

There is no need to remove the headlight to replace bulbs.

Complete operations only in the sequence given:

fig. 203, fig. 204	Indicators (small lamp holder)	(A)	(B)	(C)	Side lights
		Dipped beam headlights	Daylight driving lights	Main beam headlights	
1.	Always take the checklist into account and take the necessary actions ⇒ page 327.				
2.	Open the bonnet ⚠ ⇒ page 275.				

fig. 203, fig. 204	A		B	C	
	Indicators (small lamp holder)	Dipped beam headlights	Daylight driving lights	Main beam headlights	Side lights
3.	Remove the rubber cover on the rear of the headlight.				
4.	Rotate the lamp holder ① to the left all the way and pull it out backwards with the bulb.	Rotate the lamp holder to the left all the way and pull it out backwards with the bulb.		Press the wire clip downwards and pull the lamp holder ② out with the bulb.	Pull the lamp holder ③ out backwards with the bulb.
5.	Depending on the model, the bulb is removed directly from the lamp holder or it may need to be rotated and then removed.				
6.	Replace the faulty bulb by a new identical bulb.				
7.	Place the bulb holder in the headlight and rotate to the right all the way.			Place the lamp holder in the headlight and pull the wire clip upwards until it clicks into place.	Place the lamp holder in the headlight and insert completely.
8.	Insert the rubber cover.				



Note

The images show the left hand headlight from behind. The structure of the right hand side headlight is symmetric. ■

To replace the xenon headlights bulb

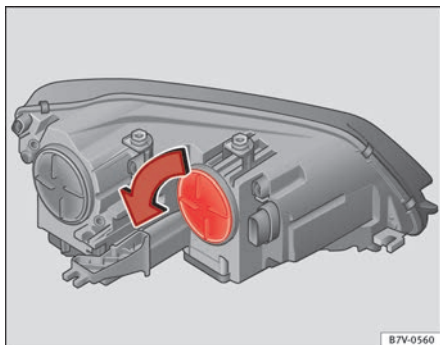

Fig. 205 In the engine compartment: Turn signal cover.

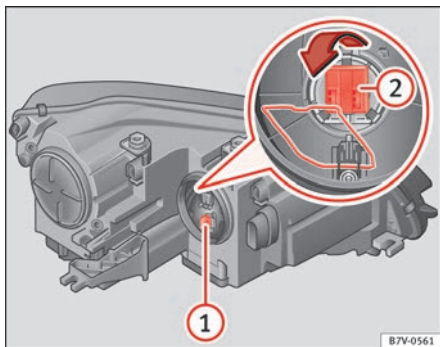



Fig. 206 Turn signal indicator lamp holder (1) and turning light (2).

There is no need to remove the headlight to replace bulbs.

Complete operations only in the sequence given:

	Turn signal indicators (1)	Turning lights (2)
1.	Always take the checklist into account and take the necessary actions ⇒ page 327.	
2.	Open the bonnet  ⇒ page 275.	
3.	Rotate the cover ⇒ fig. 205 in the direction of the arrow and remove it.	
4.	Rotate the lamp holder (1) ⇒ fig. 206 to the left all the way and pull it out backwards with the bulb.	Press the wire clip downwards and pull the lamp holder (2) ⇒ fig. 206 out with the bulb.
5.	Depending on the model, the bulb is removed directly from the lamp holder or it may need to be rotated and then removed.	
6.	Replace the faulty bulb by a new identical bulb.	
7.	Place the bulb holder in the headlight and rotate to the right all the way.	Place the lamp holder in the headlight and pull the wire clip upwards until it clicks into place.
8.	Rotate the cover ⇒ fig. 205 in the opposite direction to the arrow as far as it will go.	

Always seek the help of a specialist when changing the Xenon dipped beam and full beam headlamps ⇒  in Introduction on page 326.



Note

The illustrations show the left hand headlight. The structure of the right hand side headlight is symmetric. ■

To replace the front bumper bulbs

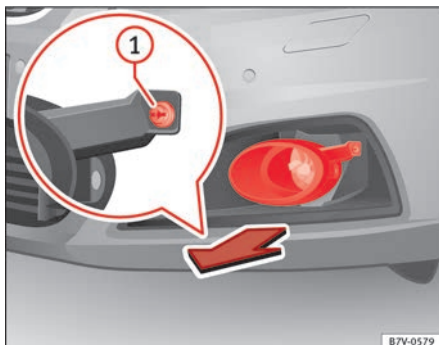

Fig. 207 On the right-hand side of the front bumper: Removing the headlights

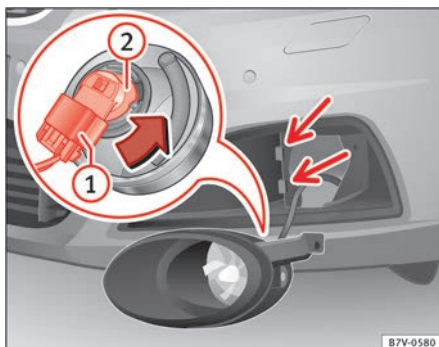

Fig. 208 Changing the bulbs in the headlights.

Complete operations only in the sequence given:

1. Always take the checklist into account and take the necessary actions ⇒ page 327.
2. Pull the cover forwards, in the direction of the arrow ⇒ fig. 207.
3. Unscrew the attachment screw ⇒ fig. 207 ① using the screwdriver from the on-board tools ⇒ page 320.
4. Tilt the headlight slightly forward and extract it from its lateral attachments ⇒ fig. 208 (small arrows).
5. Release the connector ⇒ fig. 208 ① and remove it.
6. Rotate the lamp holder ⇒ fig. 208 ② to the left all the way, in the direction of the arrow, and pull it out backwards with the bulb.
7. Replace the faulty bulb by a new identical bulb.
8. Place the bulb holder in the headlight and rotate to the right all the way.
9. Insert the connector ⇒ fig. 208 ① on the lamp holder ⇒ fig. 208 ②. The connector must audibly click into place.
10. Place the headlight into its position ⇒ fig. 208 (small arrows) and tilt it backwards.
11. Tighten the attachment screw ⇒ fig. 207 ① using the screwdriver.
12. Replace the cover on the bumper ⇒ fig. 207.

To replace the tailgate light bulbs

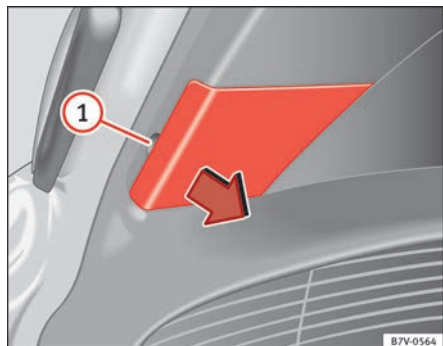

Fig. 209 On the boot lid:
Remove the cover.

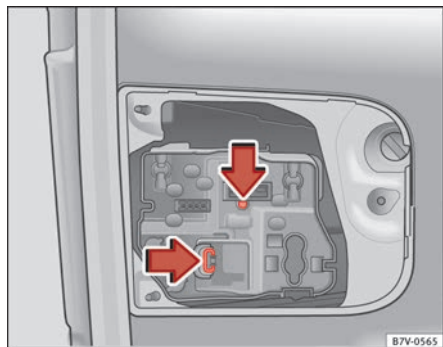

Fig. 210 On the boot lid:
Remove the lamp holder.

Complete operations only in the sequence given:

1. Always take the checklist into account and take the necessary actions ⇒ page 327.
2. Open the tailgate ⇒ page 84.
3. Extract the cover carefully using the flat part of the screwdriver as a lever (⇒ fig. 198) on the indent ⇒ fig. 209 ①.
4. Release the lamp holder connector by pulling on the red connector block.
5. Press on the attachment tabs in the direction of the arrow ⇒ fig. 210 and pull out the lamp holder.
6. Replace the faulty bulb by a new identical bulb.
7. Install the lamp holder. The attachment tabs should audibly click into place.
8. Insert the cover. The cover should lock into place. ■

To replace the tail light bulbs

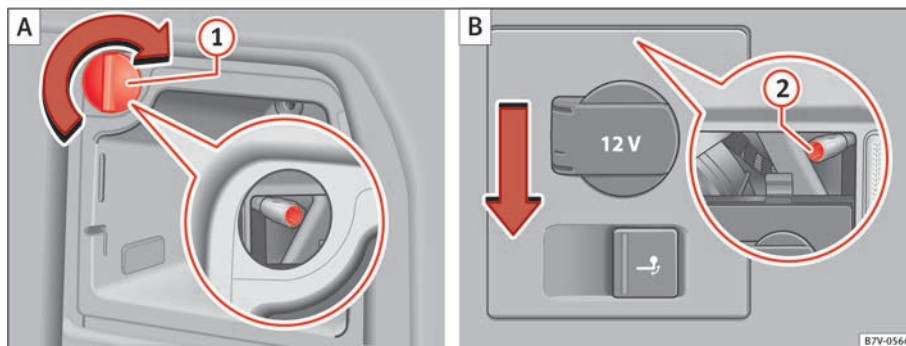

Fig. 211 On the side of the luggage compartment: To remove the left and right hand side tail lights. ① remove the cap; ② attachment screw.

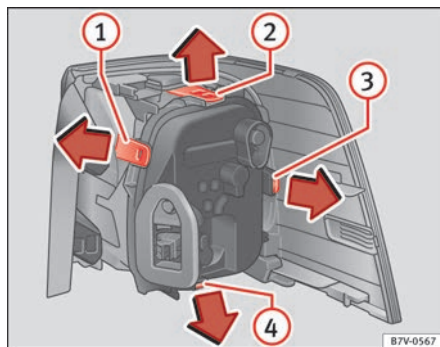

Fig. 212 Tail lights on bodywork: To remove the lamp holder. ① to ④: Attachment tab.

Complete operations only in the sequence given.

Removing the tail light units

Complete operations only in the sequence given:

	Rear light, left	Rear light, right
1.	Always take the checklist into account and take the necessary actions ⇒ page 327.	
2.	Open the tailgate ⇒ page 84.	
3.	Open the storage compartments on the left-hand side of the luggage compartment ⇒ page 141.	Move the 12 V socket support by pressing gently downwards ⇒ fig. 211 (B) (arrow).
4.	Rotate the cap ⇒ fig. 211 ① 90° in the direction of the arrow and remove it.	
5.	Unscrew the attachment screw ⇒ fig. 211 ② using the screwdriver from the on-board tools ⇒ page 320. The bolt is secured in its position.	
6.	Extract the tail light from the bodywork by carefully pulling backwards.	
7.	Pull the red strip on the connector and extract the connector.	
8.	Disassemble the tail light unit and place it on a flat, clean surface. ▶	

To change the bulb

9.	To release the lamp holder, press on the attachment tabs ⇒ fig. 212 ① to ④ in the direction of the arrow.
10.	Remove the lamp holder from the tail light unit.
11.	Replace the faulty bulb by a new identical bulb.
12.	Place the lamp holder in the tail light unit. The attachment tabs should audibly click into place.
13.	Insert the connector and press the red attachment strip in so that the connector is locked into place.

Assembling the tail light units

Complete operations only in the sequence given:

	Rear light, left	Rear light, right
14.	Carefully insert the tail light unit into the opening in the bodywork. To do this, insert the upper tail light unit guide into the attachment ring.	
15.	Tighten the white attachment screw using the screwdriver from the on-board tools.	

	Rear light, left	Rear light, right
16.	Ensure that the tail light unit has been correctly fitted and is firmly secured.	
17.	Replace the cap ① and rotate it 90° in the opposite direction of the arrow.	Move the 12 V socket support upwards gently until it is correctly closed.
18.	Close the storage compartment.	
19.	Close the tailgate ⇒ page 84.	

Changing the number plate light

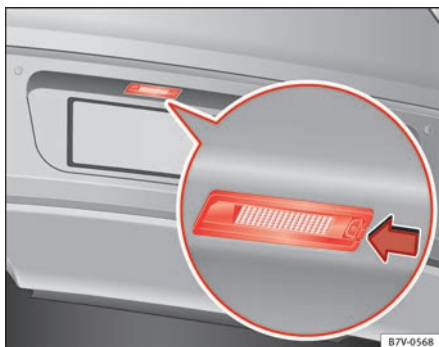

Fig. 213 On the rear bumper: number plate lights.

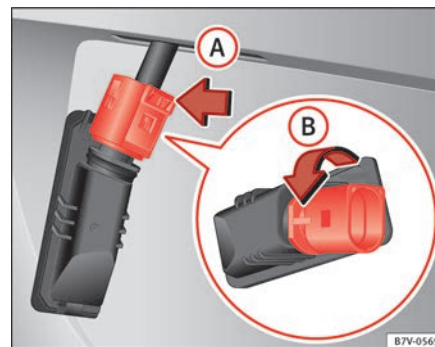

Fig. 214 Number plate light: To remove the lamp holder.

Complete operations only in the sequence given:

	Fixed number plate light	Bolted number plate light
1.	Always take the checklist into account and take the necessary actions ⇒ page 327.	
2.	Press the flat part of the screwdriver included in the vehicle on-board tools (⇒ fig. 198) in the direction of the arrow, in the groove of the number plate light ⇒ fig. 213.	Unscrew the number plate light screws using the screwdriver from the on-board tools (⇒ fig. 198).
3.	Detach the number plate light.	
4.	Press on the connector lock in the direction of the arrow ⇒ fig. 214 (A) and pull out the connector.	Separate the attachment tabs from the rear panel of the number plate light by pressing.
5.	Rotate the lamp holder in the direction of the arrow ⇒ fig. 214 (B) and extract it with the lamp.	Take the lamp holder out of the number plate light.
6.	Replace the faulty bulb by a new identical bulb.	
7.	Insert the lamp holder into the number plate light and rotate all the way in the opposite direction to the arrow ⇒ fig. 214 (B).	Insert the lamp holder into the number plate light.
8.	Plug the connector into the lamp holder.	Press on the attachment tabs. The lamp holder must be firmly attached to the number plate light. ▶

	Fixed number plate light	Bolted number plate light
9.	Insert the number plate light carefully into the opening on the bumper. Ensure that the number plate light is in the correct position.	
10.	Insert the number plate light into the bumper until it audibly clicks into place.	Tighten the attachment screws for the number plate light using the screwdriver.

Starting assistance

Introduction

If the engine fails to start because of a discharged battery, the battery of another vehicle can be used to start the engine. Before starting, check the magic eye on the battery ⇒ page 288.

For starting assistance, jump lead cables conforming to the standard DIN 72553 are required (see the cable manufacturer instructions). The jump lead cable must be at least 25 mm² in section (0.038 inches²) for petrol engines, and 35 mm² (0.054 inches²) for diesel engines.

For vehicles whose battery is not in the engine compartment, the jump leads should only be connected to the starting assistance connection points in the engine compartment.

Additional information and warnings:

- Starter assist systems (Start-Stop function) ⇒ page 194
- Working in the engine compartment ⇒ page 275
- Selective Catalytic Reduction (AdBlue) ⇒ page 271
- Vehicle battery ⇒ page 288

WARNING

Incorrect use of jump leads and incorrectly jump starting could cause the battery to explode resulting in serious injury. Please observe the following rules to minimise the risk of a battery explosion:

- **All work involving the vehicle battery and electrical system can cause corrosion, fire and serious electric shocks. Always read and take into account the safety warnings and standards before beginning work on the battery ⇒ page 288, Vehicle battery.**

WARNING (Continued)

- **The battery providing current must have the same voltage (12V) and approximately the same capacity (see markings on battery) as the flat battery.**
- **Never charge a frozen or recently thawed battery. A flat battery can freeze at temperatures around 0 °C (+32 °F).**
- **If a battery is frozen and/or has been frozen then it must be replaced.**
- **A highly explosive mixture of gases is released when the battery is being charged. Always keep lit cigarettes, open flames, sparks and fire far from the battery. Never use a mobile telephone when connecting and removing the jump leads.**
- **Charge the battery only in well ventilated areas given that when the battery is charged by outside assistance, it creates a mix of highly explosive gases.**
- **Jump leads should never enter into contact with moving parts in the engine compartment.**
- **Never switch the positive and negative poles or connect the jump leads incorrectly.**
- **Note the instructions provided by the manufacturer of the jump leads.**

CAUTION

To avoid considerable damage to the vehicle electrical system, note the following carefully:

- If the jump leads are incorrectly connected, this could result in a short circuit.
- The vehicles must not touch each other, otherwise electricity could flow as soon as the positive terminals are connected. ■

Positive pole on the starting assistance points

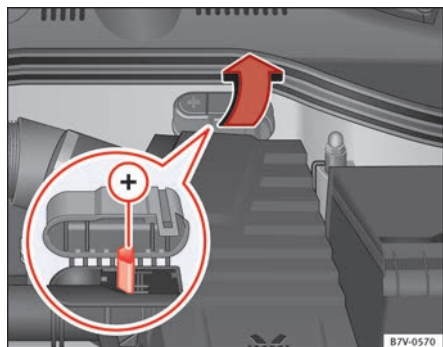

Fig. 215 In the engine compartment: positive pole for starting assistance (+).

On some vehicles, there is a starting assistance terminal in the engine compartment, under a labelled cover.

How to jump start: description

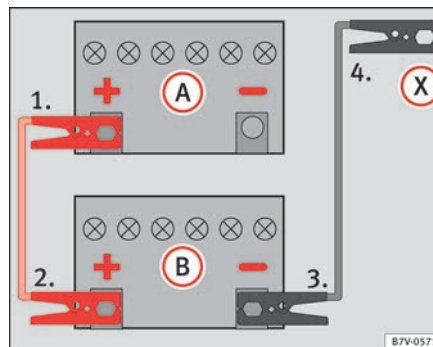

Fig. 216 Jump lead connection diagram when the assistance vehicle does not have a Start-Stop system: flat battery (A) and battery supplying current (B).

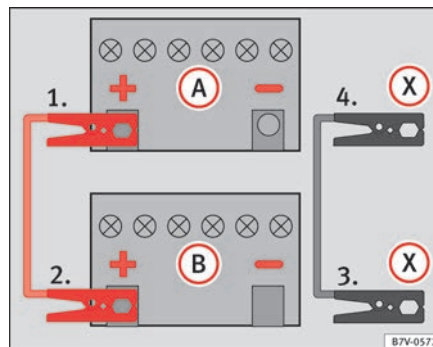

Fig. 217 Jump lead connection diagram when the assistance vehicle has a Start-Stop system: flat battery (A) and battery supplying current (B).

The discharged battery must be properly connected to the vehicle electrical system.

The vehicles should not touch. Otherwise, current may be allowed to flow when the positive poles are connected.

Connect the clamps so they have good metal-to-metal contact with the terminals.

If the engine fails to start straight-away, switch off the starter after about 10 seconds and try again after about a minute.

Complete operations only in the sequence given.

Jump lead terminal connections

- Switch off the ignition of both vehicles ⇒ page 170.
- Likewise, open the battery cover in the engine compartment ⇒ page 288, or remove the positive pole cap from one side¹⁾, in the direction of the arrow ⇒ fig. 215.
- Connect one end of the *red* jump lead to the positive terminal ⇒ fig. 216 (+) or ⇒ fig. 215 (+) of the vehicle with the flat battery (A) ⇒ ⚠.
- Connect the other end of the *red* jump lead to the positive terminal (+) in the vehicle providing assistance (B).
- For vehicles **without Start-Stop system**: Connect one end of the *black* jump lead to the negative terminal (-) in the vehicle providing assistance (B) ⇒ fig. 216.
- For vehicles **with Start-Stop system**: Connect one end of the *black* (X) jump lead to a suitable ground connection, a solid piece of metal in the engine block, or to the engine block ⇒ fig. 217.
- Connect the other end of the *black* jump lead (X) to a solid metal component connected to the engine block, or onto the engine block itself of the vehicle with the flat battery however, connect it as far away as possible from the battery (A) ⇒ ⚠.
- Place the leads so that they cannot be caught by any moving parts in the engine compartment.

¹⁾ Vehicles whose battery is not located in the engine compartment ⇒ page 338.

Switching on

- Start the engine of the vehicle supplying current and let it run at idling speed.
- Start the engine of the car with the flat battery and wait two or three minutes until the engine is “running smoothly”.

Removing the jump leads

- Before you remove the jump leads, switch off the headlights (if they are switched on).
- Turn on the heating and rear window heater in the vehicle with the flat battery. This helps minimise voltage peaks which are generated when the leads are disconnected.
- With the engines running, disconnect the leads in reverse order to connection.
- Close the battery cover, or replace the positive pole cap¹⁾.



WARNING

Incorrectly jump starting could cause the battery to explode resulting in serious injury. Please observe the following rules to minimise the risk of a battery explosion:

- **All work involving the vehicle battery and electrical system can cause corrosion, fire and serious electric shocks. Always read and take into account the safety warnings and standards before beginning work on the battery ⇒ page 288, Vehicle battery.**
- **Always protect your eyes with suitable working goggles and never lean over the vehicle battery.**
- **The jump leads must be connected in the correct order: first the positive cable, then the negative cable.**

 **WARNING** (Continued)

- Do not attach the negative cable to parts of the fuel system or to the brake hose/pipe.
- The non-insulated parts of the battery clamps must not be allowed to touch. Also, the cable connected to the positive pole of the battery should never enter into contact with electrically conductive parts of the vehicle.
- Check the magic eye on the battery; use a lamp if necessary. If it is clear yellow or clear, do not start the vehicle: seek specialised technical assistance.
- Avoid static electricity discharges in the area around the battery. In the event of sparks, explosive gases coming from the battery could ignite.
- Never use starting assistance if the vehicle battery is damaged, frozen or has been frozen.

Towing and tow starting

Introduction

When towing, always respect legal requirements.

For technical reasons, it is not possible to tow a vehicle if the battery is flat.

Additional information and warnings:

- Electronic power control and exhaust gases purification system
⇒ page 228

 **WARNING**

A vehicle with a flat battery should never be towed.

- Never remove the key from the ignition lock. The electronic steering lock could engage. Then the vehicle will be uncontrollable. You may lose control of the vehicle and there is a risk of serious accident.

 **WARNING**

When towing the vehicle, the handling and braking efficiency change considerably. Please observe the following instructions to minimise the risk of serious accidents and injury:

- As the driver of the vehicle being towed:
 - The brake must be depressed must harder as the brake servo does not operate. Always remain aware to avoid collision with the towing vehicle.
 - More strength is required at the steering wheel as the power steering does not operate when the engine is switched off.
- As the driver of the towing vehicle:
 - Accelerate gently and carefully.
 - Avoid sudden braking and manoeuvres.
 - Brake well in advance than usual and brake gently.

 **CAUTION**

- Carefully fit and remove the towing ring and its cover to avoid damage to the vehicle (for example, paintwork).
- When towing, fuel could enter the catalytic converter and cause damage!

Instructions for tow starting

In general, the vehicle should not be started by towing. Jump-starting is much more preferable ⇒ page 337.

For technical reasons, the following vehicles can **not** be tow started:

- Vehicles with an automatic gearbox.
- Vehicles with an electronic parking brake, given that it is possible that the brake will not be disengaged.
- If the vehicle battery is flat, it is possible that the engine control units do not operate correctly.

However, if your vehicle must absolutely be tow-started (manual gearbox):

- Engage the 2nd or 3rd gear.
- Keep the clutch pressed down.
- Switch on the ignition and the hazard warning lights.
- Release the clutch when both vehicles are moving.
- As soon as the engine starts, press the clutch and move the gear lever into neutral. This helps to prevent a collision with the towing vehicle.



CAUTION

When tow-starting, fuel could enter the catalytic converter and damage it. ■

Towing instructions

Tow-rope or tow-bar

When towing, the tow bar is the safest and vehicle friendly way. You should only use a tow-rope if you do not have a tow-bar.

A tow-rope should be slightly elastic to avoid damage to both vehicles. It is advisable to use a tow-rope made of synthetic fibre or similarly elastic material.

Only secure the tow rope or tow bar to the tow ring or specially designed fitting.

Vehicles with a **factory fitted towing device**, can **only** be used for towing with a tow-bar, specially designed to fit on a tow hitch ball ⇒ page 233.

Towing vehicles with an automatic gearbox

Note the following for a towed vehicle:

- Make sure the gear selector lever is in the **N** position.
- Do not drive faster than 50 km/h (30 mph) when towing a vehicle.
- Do not tow further than 50 km (30 miles).
- If a breakdown truck is used, the vehicle must be towed with the front wheels raised. Note the following instructions for towing four wheel drive vehicles.

Instructions for towing four-wheel-drive vehicles

Four wheel drive vehicles can be towed using a toolbar or tow rope. If the vehicle is towed with the front or rear axle raised, the engine must be turned off to avoid transmission damage.

For vehicles with a double clutched DSG® (direct shift gearbox) the instructions for towing vehicles with an automatic gearbox apply ⇒ page 341.

Situations in which the vehicle should not be towed

In the following cases, the vehicle should not be towed but transported on a trailer or special vehicle:

- If the vehicle gearbox does not contain lubricant due to a fault.
- If the vehicle battery is flat and, as a result, the electronic steering lock and electronic parking brake cannot be disengaged if applied.
- If the vehicle to be towed has an automatic gearbox and the distance to be covered is greater than 50 km (30 miles). ▶

**Note**

The vehicle can only be towed if the electronic parking brake and steering lock are deactivated. If the vehicle has no power supply or there is an electric system fault, the engine must be started using jump leads to deactivate the electronic parking brake and electronic steering lock. ■

Fitting the front tow ring

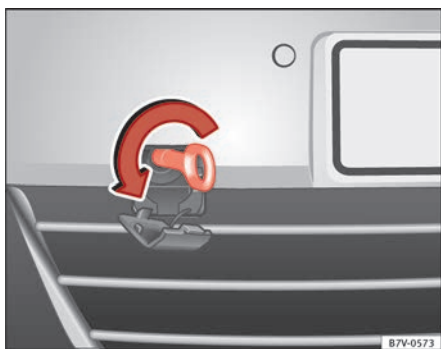

Fig. 218 On the right-hand side of the front bumper: Screw in the towing ring.

The location for the removable tow ring is on the right-hand side of the front bumper ⇒ **fig. 218**.

The towing eye should always be kept in the vehicle.

Note the instructions for towing ⇒ page 341.

To fit the tow ring

- Take the tow ring from the vehicle tool kit ⇒ page 320.
- Press on the upper cover and carefully remove it forwards. Allow the cover to hang.

- Screw in the tow ring into its position **anticlockwise** as far as it will go ⇒ **fig. 218** ⇒ . Use a suitable tool to firmly tighten the tow ring in its location.
- After towing, remove the tow ring by turning it **clockwise** and put the cover back in place.

**CAUTION**

The tow ring must always be completely and firmly tightened. Otherwise, it could be released while towing and tow-starting. ■

Fitting the rear tow ring

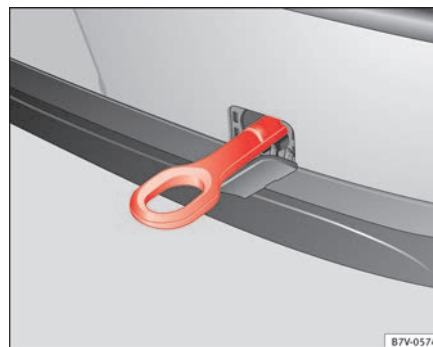

Fig. 219 On the rear bumper, to the right hand side: Tow ring in position.

The location for the removable tow ring is on the right-hand side of the rear bumper ⇒ **fig. 219**. For *vehicles with a factory fitted trailer system*, there is **no** fitting behind the cover to insert the tow ring. For towing, fit and use the trailer hitch ⇒ page 233, ⇒ .

Note the instructions for towing ⇒ page 341. ►

Fitting the tow ring to the rear for vehicles without factory fitted tow hitch

- Take the tow ring from the on-board tools ⇒ page 320.
- Press on the upper cover and carefully remove it back. This may require some strength. Allow the cover to hang.
- Screw in the tow ring into its position **anticlockwise** as far as it will go ⇒ ④. Use a suitable tool to firmly tighten the tow ring in its location.
- After towing, remove the tow ring by turning it **clockwise** and put the cover back in place.



CAUTION

- The tow ring must always be completely and firmly tightened. Otherwise, it could be released while towing and tow-starting.
- Vehicles with a factory fitted towing device, **can** only be used for towing with a tow-bar, specially designed to fit on a tow hitch ball. Otherwise, the tow hitch ball and the vehicle may be damaged. Otherwise, a tow rope should be used.

Towing advice

Towing requires some experience, especially when using a tow-rope. Both drivers should be familiar with the technique required for towing. For this reason, inexperienced drivers should abstain.

While driving, avoid excessive traction forces and jerking. When towing on an unpaved road, there is always a risk of overloading and damaging the anchorage points.

If the vehicle is towed, with the hazard warning lights on and the ignition switched on, the turn signal may be used to indicate changes of direction. Simply operate the turn indicator lever as usual. Meanwhile, the hazard warning lights will go off. When the turn signal lever is returned to the rest position, the hazard warning lights will be turned on automatically.

Notes for the driver of the towed vehicle

- Leave the ignition on to avoid locking the steering wheel, to release the electronic parking brake and to activate the turn signal indicators, the horn as well as the window wipers and window washers.
- As the power assisted steering does not work if the engine is not running, you will need more strength to steer than normally.
- The brake must be depressed much harder as the brake servo does not operate. Avoid hitting the towing vehicle.
- Note the instructions and information contained in the instruction manual for the vehicle to be towed.

Notes for the driver of the towing vehicle

- Accelerate gently and carefully. Avoid sudden manoeuvres.
- Brake well in advance than usual and brake gently.
- Note the instructions and information contained in the instruction manual for the vehicle to be towed.

Technical Specifications

Description of specifications

Important information

Important

The information in the vehicle documentation always has precedence.

All technical specifications provided in this manual are valid for the standard model in Spain. The vehicle data card included in the Inspection and Maintenance Plan in the vehicle documents shows which engine is installed in the vehicle.

The figures may be different depending on if additional equipment is fitted, for different models, for special vehicles and for other countries.

Additional information and warnings:

- Transporting ⇒ page 13
- Ecological driving ⇒ page 225
- Fuel ⇒ page 267
- Engine oil ⇒ page 279
- Engine coolant ⇒ page 283
- Wheels and tyres ⇒ page 293
- Notes for the user ⇒ page 255

Abbreviations used in the Technical Specifications section

Abbreviation	Meaning
kW	Kilowatt, engine power measurement.
PS	Pferdestärke (horsepower), formerly used to denote engine power.
rpm	Revolutions per minute - engine speed.
Nm	Newton metres, unit of engine torque.
l/100 km	Fuel consumption in litres per 100 km.
g/km	Carbon dioxide emissions in grams per km travelled.
CO ₂	Carbon dioxide
CN	Cetane number, indication of the diesel combustion power.
RON	Research octane number, indication of the knock resistance of petrol.



WARNING

Failure to observe requirements for weight, loads, dimensions and maximum speed may lead to severe accident.

Vehicle code



Fig. 220 Vehicle identification number.

Vehicle identification number

The vehicle identification number (chassis number) can be read from outside the vehicle through a viewer in the windscreen ⇒ fig. 220. This viewer is located in the lower part of the windscreen. The vehicle identification number (chassis number) is also stamped on the right water drain channel. The water drain channel is located between the suspension tower and the wing. Open the bonnet to read the vehicle identification number ▲ ⇒ page 275.

Vehicle data plate

The vehicle data plate is attached to the luggage compartment, and contains the following information:

- ① Vehicle identification number (chassis number)
- ② Vehicle type, engine power, gearbox type
- ③ Engine and gearbox code, paint number, interior equipment.
- ④ Optional extras, PR numbers

These data are also provided in the Maintenance Programme.

Type plate

The type plate is visible when the driver door is opened, on the lower part of the strut. Vehicles for certain export countries do not have a type plate.

The manufacturer's type plate contains the following data:

- ⑤ Gross vehicle weight
- ⑥ Maximum authorised weight of vehicle and trailer
- ⑦ Maximum gross front axle weight
- ⑧ Maximum rear axle weight

Information on fuel consumption

Fuel consumption

The consumption and emission details shown on the vehicle data sticker differ from one vehicle to another.

The fuel consumption, CO₂ emissions and actual kerb weight of the vehicle are noted on the vehicle data sticker.

The fuel consumption and emissions figures given are based on the vehicle weight category, which is determined according to the engine/gearbox combination and the equipment fitted.

The consumption and emission figures are calculated in accordance with the EC test requirements 1999/100/EC. These test requirements specify a realistic test method based on normal everyday driving.

The following test conditions are applied:

Urban cycle	The urban cycle starts with an engine cold start. City driving is then simulated.
Extra urban cycle	In the extra urban cycle simulation the vehicle frequently accelerates and brakes in all gears, as in normal everyday driving. The road speed ranges from 0 to 120 km/h.
Total consumption	The average total consumption is calculated with a weighting of around 37% for the urban cycle and 63% for the extra urban cycle.
CO ₂ emissions	The exhaust gases are collected during both driving cycles to calculate carbon dioxide emissions. The gas composition is then analysed to evaluate the CO ₂ content and other emissions.



Note

- Actual consumption may vary from quoted test values, depending on personal driving style, road and traffic conditions, the weather and the vehicle condition.

Weights

Kerb weight refers to the basic model with a fuel tank filled to 90% capacity and without optional extras. The figure quoted includes 75 kg to allow for the weight of the driver.

For special versions and optional equipment fittings or for the addition of accessories, the weight of the vehicle will increase ⇒ ⚠.



WARNING

- Please note that the centre of gravity may shift when transporting heavy objects; this may affect the vehicle's handling and lead to an accident. Always adjust your speed and driving style to suit road conditions and requirements.**
- Never exceed the gross axle weight rating or the gross vehicle weight rating. If the allowed axle load or the allowed total weight is exceeded, the driving characteristics of the vehicle may change, leading to accidents, injuries and damage to the vehicle.**

Towing a trailer

Trailer weights

Trailer weight

The trailer weights and drawbar loads approved are selected in intensive trials according to precisely defined criteria. The approved trailer weights are valid for vehicles in the *EU* for maximum speeds of 80 km/h (in certain circumstances up to 100 km/h). The figures may be different in other countries. All data in the official vehicle documents take precedence over these data ⇒ ⚠.

Drawbar load

The *maximum* permitted weight exerted by the trailer drawbar on the ball joint of the towing bracket must not exceed **100 kg**.

In the interest of road safety, we recommend that you always tow approaching the maximum drawbar load. The response of the trailer on the road will be poor if the drawbar load is too small.

If the maximum permissible drawbar load cannot be met (e.g. with small, empty and light-weight single axle trailers or tandem axle trailers with a wheelbase of less than 1 metre), a minimum of 4% of the actual trailer weight is legally required for the drawbar load.

WARNING

- For safety reasons, do not exceed the 80 km/h limit. This is also valid in countries where higher speeds are permitted.
- Never exceed the maximum trailer weights or the drawbar load. If the permissible axle load or the permissible total weight is exceeded, the driving characteristics of the vehicle may change, leading to accidents, injuries and damage to the vehicle.

Wheels

Tyre pressure, snow chains, wheel bolts

Tyre pressures

The sticker with the tyre pressure values can be found on the inside of the tank flap. The tyre pressure values given there are for *cold* tyres. The slightly raised pressures of warm tyres must not be reduced. ⇒ ⚠

Snow chains

Snow chains may be fitted only to the *front wheels*.

Consult the chapter “wheels” of this manual.

Wheel bolts

After the wheels have been changed, the **tightening torque** of the wheel bolts should be checked as soon as possible with a torque wrench ⇒ ⚠. The tightening torque for steel and alloy wheels is **120 Nm**.

WARNING

- Check the tyre pressure at least once per month. Checking the tyre pressure is very important. If the tyre pressure is too high or too low, there is an increased danger of accidents, particularly at high speeds.
- If the torque of the wheel bolts is too low, they could loosen while the vehicle is in motion. Risk of accident! If the tightening torque is too high, the wheel bolts and threads can be damaged.

Note

We recommend that you ask your Authorised Service Centre for information about appropriate wheel, tyre and snow chain size.

Technical specifications

Checking fluid levels

From time to time, the levels of the different fluids in the vehicle must be checked. Never fill with incorrect fluids, otherwise serious damage to the engine may be caused.

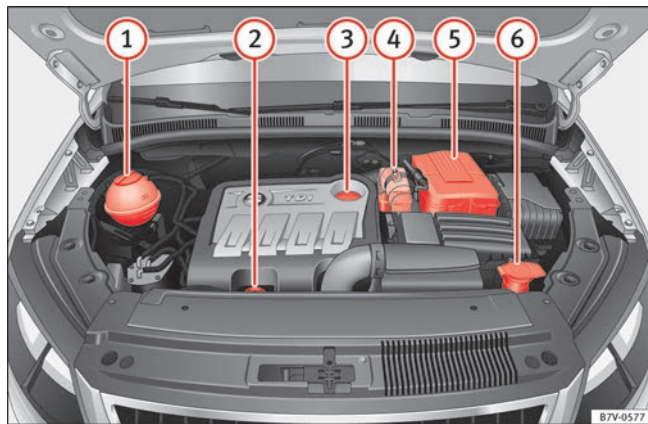

Fig. 221 Diagram for the location of the various elements

- ① Coolant fluid deposit
- ② Engine oil dipstick
- ③ Oil filler neck
- ④ Brake fluid reservoir
- ⑤ Vehicle battery (underneath a cover)
- ⑥ Windscreen washer fluid reservoir

The checking and refilling of service fluids are carried out on the components mentioned above. These operations are described in ⇒ page 275.

Overview

Further explanations, instructions and restrictions on the technical data are contained as of ⇒ page 344

Petrol engine 1.4 110 kW (150 PS)

Engine specifications

Power output in kW (PS)	rpm	110 (150)/ 5800
Maximum torque	in Nm at rpm	240/ 1500-4000
No. of cylinders/capacity	in cm ³	4/ 1390
Fuel		95 super RON ^{a)}

a) Research Octane Number = Anti-detonation rating of the petrol.

Performance

Maximum speed	in km/h	197
Acceleration from 0-80 km/h	in sec.	6.9
Acceleration from 0-100 km/h	in sec.	10.7

Consumption (litres/100 km)/ CO₂ (g/km)

Urban cycle	9.2/214
Extra-urban cycle	6.1/143
Combined	7.2/167

Weights

		5 seats	7 seats
Gross vehicle weight	in kg	2290	2480
Weight in running order (with driver)	in kg	1723	1771
Gross front axle weight	in kg	1170/1220	1170/1220
Gross rear axle weight	in kg	1070/1120	1260/1310
Permitted roof load	in kg	100	100

Trailer weight

Trailer without brakes	750
Trailer with brakes, gradients up to 8%	1800
Trailer with brakes, gradients up to 12%	1800

Engine oil capacity

Approximate engine oil capacity with oil filter change	3.6
--	-----

Petrol engine 1.4 110 kW (150 PS) Automatic

Engine specifications

Power output in kW (PS)	rpm	110 (150)/ 5800
Maximum torque	in Nm at rpm	240/ 1500-4000
No. of cylinders/capacity	in cm ³	4/ 1390
Fuel		Super 95 RON ^{a)}

a) Research Octane Number = Anti-detonation rating of the petrol.

Performance

Maximum speed	in km/h	197
Acceleration from 0-80 km/h	in sec.	6.6
Acceleration from 0-100 km/h	in sec.	9.9

Consumption (litres/100 km)/ CO₂ (g/km)

Urban cycle	9.4/218
Extra-urban cycle	6.6/154
Combined	7.6/178

Weights

		5 seats	7 seats
Gross vehicle weight	in kg	2310	2500
Weight in running order (with driver)	in kg	1742	1790
Gross front axle weight	in kg	1190/1240	1190/1240
Gross rear axle weight	in kg	1070/1120	1260/1310
Permitted roof load	in kg	100	100

Trailer weight

Trailer without brakes	750
Trailer with brakes, gradients up to 8%	1800
Trailer with brakes, gradients up to 12%	1800

Engine oil capacity

Approximate engine oil capacity with oil filter change	3.6
--	-----

Petrol engine 2.0 147 kW (200 PS) Automatic

Engine specifications

Power output in kW (PS)	rpm	147 (200)/ 5100
Maximum torque	in Nm at rpm	280/ 1700-5000
No. of cylinders/capacity	in cm ³	4.6/ 1984
Fuel		Super 95 RON ^{a)}

^{a)} Research Octane Number = Anti-detonation rating of the petrol.

Performance

Maximum speed	in km/h	221
Acceleration from 0-80 km/h	in sec.	5.8
Acceleration from 0-100 km/h	in sec.	8.3

Consumption (litres/100 km)/ CO₂ (g/km)

	5 seats	7 seats
Urban cycle	11.5/268	11.6/270
Extra-urban cycle	6.6/155	6.7/156
Combined	8.4/196	8.5/198

Weights

		5 seats	7 seats
Gross vehicle weight	in kg	2360	2530
Weight in running order (with driver)	in kg	1790	1838
Gross front axle weight	in kg	1100/1150	1220/1270
Gross rear axle weight	in kg	1100/1150	1260/1310
Permitted roof load	in kg	100	100

Trailer weight

Trailer without brakes	750
Trailer with brakes, gradients up to 8%	2000
Trailer with brakes, gradients up to 12%	2000

Engine oil capacity

Approximate engine oil capacity with oil filter change	4.6
--	-----

Diesel engine 2.0 TDI CR 85 kW (115 PS)**Engine specifications**

Power output in kW (PS)	rpm	85 (115)/ 4200
Maximum torque	in Nm at rpm	280/1750-2500

No. of cylinders/capacity	in cm ³	4.6/1984
Fuel		Min. 51 CN ^{a)}

a) Cetane Number (cetane index) = Measure of the combustion power of the diesel

Performance

Maximum speed	in km/h	183
Acceleration from 0-80 km/h	in sec.	12.6
Acceleration from 0-100 km/h	in sec.	14

Consumption (litres/100 km)/ CO₂ (g/km)

	5 seats	7 seats
Urban cycle	6.8/179	6.9/182
Extra-urban cycle	4.8/127	4.9/130
Combined	5.5/143	5.6/146

Weights

		5 seats	7 seats
Gross vehicle weight	in kg	2360	2530
Weight in running order (with driver)	in kg	1772	1823
Gross front axle weight	in kg	1210/1260	1210/1260
Gross rear axle weight	in kg	1100/1150	1260/1310
Permitted roof load	in kg	100	100

Trailer weight

Trailer without brakes	750
Trailer with brakes, gradients up to 8%	2000
Trailer with brakes, gradients up to 12%	2000

Engine oil capacity

Approximate engine oil capacity with oil filter change	4.0
--	-----

Diesel engine 2.0 TDI CR 100 kW (136 PS)

Engine specifications

Power output in kW (PS)	rpm	100 (136)/ 4200
Maximum torque	in Nm at rpm	320/1750-2500
No. of cylinders/capacity	in cm ³	4/1968
Fuel		Min. 51 CN ^{a)}

a) Cetane Number (cetane index) = Measure of the combustion power of the diesel

Performance

Maximum speed	in km/h	192
Acceleration from 0-80 km/h	in sec.	7.8
Acceleration from 0-100 km/h	in sec.	11.1

Consumption (litres/100 km)/ CO₂ (g/km)

	5 seats	7 seats
Urban cycle	6.8/179	6.9/182
Extra-urban cycle	4.8/127	4.9/130
Combined	5.5/143	5.6/146

Weights

		5 seats	7 seats
Gross vehicle weight	in kg	2340	2510
Weight in running order (with driver)	in kg	1174	1822
Gross front axle weight	in kg	1190/1240	1200/1250
Gross rear axle weight	in kg	1100/1150	1260/1310
Permitted roof load	in kg	100	100

Trailer weight

Trailer without brakes	750
Trailer with brakes, gradients up to 8%	2200
Trailer with brakes, gradients up to 12%	2200

Engine oil capacity

Approximate engine oil capacity with oil filter change	4.0
--	-----

Diesel engine 2.0 TDI CR 100 kW (136 PS) Automatic

Engine specifications

Power output in kW (PS)	rpm	100 (136)/ 4200
Maximum torque	in Nm at rpm	320/1750-2500
No. of cylinders/capacity	in cm ³	4/1968
Fuel		Min. 51 CN ^{a)}

^{a)} Cetane Number (cetane index) = Measure of the combustion power of the diesel

Performance

Maximum speed	in km/h	189
Acceleration from 0-80 km/h	in sec.	7.8
Acceleration from 0-100 km/h	in sec.	11.1

Consumption (litres/100 km)/ CO₂ (g/km)

Urban cycle	6.9/182
Extra-urban cycle	5/132
Combined	5.7/149

Weights

		5 seats	7 seats
Gross vehicle weight	in kg	2370	2540
Weight in running order (with driver)	in kg	1803	1851
Gross front axle weight	in kg	1220/1270	1230/1280
Gross rear axle weight	in kg	1100/1150	1260/1310
Permitted roof load	in kg	100	100

Trailer weight

Trailer without brakes	750
Trailer with brakes, gradients up to 8%	2200
Trailer with brakes, gradients up to 12%	2200

Engine oil capacity

Approximate engine oil capacity with oil filter change	4.0
--	-----

Diesel engine 2.0 TDI CR 103 kW (140 PS)

Engine specifications

Power output in kW (PS)	rpm	103 (140)/ 4200
Maximum torque	in Nm at rpm	320/1750-2500
No. of cylinders/capacity	in cm ³	4/1968
Fuel		Min. 51 CN ^{a)}

a) Cetane Number (cetane index) = Measure of the combustion power of the diesel

Performance

Maximum speed	in km/h	194
Acceleration from 0-80 km/h	in sec.	7.7
Acceleration from 0-100 km/h	in sec.	10.9

Consumption (litres/100 km)/ CO₂ (g/km)

	5 seats	7 seats
Urban cycle	6.8/179	6.9/182
Extra-urban cycle	4.8/127	4.9/130
Combined	5.5/143	5.6/146

Weights

		5 seats	7 seats
Gross vehicle weight	in kg	2340	2510
Weight in running order (with driver)	in kg	1174	1822
Gross front axle weight	in kg	1190/1240	1200/1250
Gross rear axle weight	in kg	1100/1150	1260/1310
Permitted roof load	in kg	100	100

Trailer weight

Trailer without brakes	750
Trailer with brakes, gradients up to 8%	2200
Trailer with brakes, gradients up to 12%	2200

Engine oil capacity

Approximate engine oil capacity with oil filter change	4.0
--	-----

Diesel engine 2.0 TDI CR 103 kW (140 PS) Automatic

Engine specifications

Power output in kW (PS)	rpm	103 (140)/ 4200
Maximum torque	in Nm at rpm	320/1750-2500

No. of cylinders/capacity	in cm ³	4/1968
Fuel		Min. 51 CN ^{a)}

a) Cetane Number (cetane index) = Measure of the combustion power of the diesel

Performance

Maximum speed	in km/h	191
Acceleration from 0-80 km/h	in sec.	7.7
Acceleration from 0-100 km/h	in sec.	10.9

Consumption (litres/100 km)/ CO₂ (g/km)

Urban cycle	6.9/182
Extra-urban cycle	5/132
Combined	5.7/149

Weights

		5 seats	7 seats
Gross vehicle weight	in kg	2370	2540
Weight in running order (with driver)	in kg	1803	1851
Gross front axle weight	in kg	1220/1270	1230/1280
Gross rear axle weight	in kg	1100/1150	1260/1310
Permitted roof load	in kg	100	100

Trailer weight

Trailer without brakes	750
Trailer with brakes, gradients up to 8%	2200
Trailer with brakes, gradients up to 12%	2200

Engine oil capacity

Approximate engine oil capacity with oil filter change	4.0
--	-----

Diesel engine 2.0 TDI CR 103 kW (140 PS) All-wheel drive

Engine specifications

Power output in kW (PS)	rpm	103 (140)/ 4200
Maximum torque	in Nm at rpm	320/1750-2500
No. of cylinders/capacity	in cm ³	4.6/1984
Fuel		Min. 51 CN ^{a)}

a) Cetane Number (cetane index) = Measure of the combustion power of the diesel

Performance

Maximum speed	in km/h	191
Acceleration from 0-80 km/h	in sec.	
Acceleration from 0-100 km/h	in sec.	11.4

Consumption (litres/100 km)/ CO₂ (g/km)

	5 seats	7 seats
Urban cycle	7.4/195	7.5/197
Extra-urban cycle	5.2/137	5.4/143
Combined	6.0/158	6.2/162

Weights

		5 seats	7 seats
Gross vehicle weight	in kg	2530	2550
Weight in running order (with driver)	in kg	1891	1945
Gross front axle weight	in kg	1250/1300	1240/1290
Gross rear axle weight	in kg	1230/1280	1290/1340
Permitted roof load	in kg	100	100

Trailer weight

Trailer without brakes	750
Trailer with brakes, gradients up to 8%	2400
Trailer with brakes, gradients up to 12%	2400

Engine oil capacity

Approximate engine oil capacity with oil filter change	4.0
--	-----

Diesel engine 2.0 TDI CR 125 kW (170 PS)

Engine specifications

Power output in kW (PS)	rpm	125 (170)/ 4200
Maximum torque	in Nm at rpm	350/1750-2500
No. of cylinders/capacity	in cm ³	4/1968
Fuel		Min. 51 CN ^{a)}

^{a)} Cetane Number (cetane index) = Measure of the diesel combustion power.

Performance

Maximum speed	in km/h	210
Acceleration from 0-80 km/h	in sec.	6.7
Acceleration from 0-100 km/h	in sec.	9.5

Consumption (litres/100 km)/ CO₂ (g/km)

Urban cycle	7.3/192
Extra-urban cycle	5.0/132
Combined	5.8/152

Weights

		5 seats	7 seats
Gross vehicle weight	in kg	2360	2530
Weight in running order (with driver)	in kg	1794	1842
Gross front axle weight	in kg	1210/1260	1220/1270
Gross rear axle weight	in kg	1100/1150	1260/1310
Permitted roof load	in kg	100	100

Trailer weight

Trailer without brakes	750
Trailer with brakes, gradients up to 8%	2200
Trailer with brakes, gradients up to 12%	2200

Engine oil capacity

Approximate engine oil capacity with oil filter change	4.0
--	-----

Diesel engine 2.0 TDI CR 125 kW (170 PS) Automatic

Engine specifications

Power output in kW (PS)	rpm	125 (170)/ 4200
Maximum torque	in Nm at rpm	350/1750-2500
No. of cylinders/capacity	in cm ³	4/1968
Fuel		Min. 51 CN ^{a)}

a) Cetane Number (cetane index) = Measure of the combustion power of the diesel

Performance

Maximum speed	in km/h	204
Acceleration from 0-80 km/h	in sec.	6.6
Acceleration from 0-100 km/h	in sec.	9.8

Consumption (litres/100 km)/ CO₂ (g/km)

Urban cycle	6.7/177
Extra-urban cycle	5.4/143
Combined	5.9/154

Weights

		5 seats	7 seats
Gross vehicle weight	in kg	2370	2550
Weight in running order (with driver)	in kg	1803	1851
Gross front axle weight	in kg	1220/1270	1230/1280
Gross rear axle weight	in kg	1100/1150	1260/1310
Permitted roof load	in kg	100	100

Trailer weight

Trailer without brakes	750
Trailer with brakes, gradients up to 8%	2200
Trailer with brakes, gradients up to 12%	2200

Engine oil capacity

Approximate engine oil capacity with oil filter change	4.0
--	-----

Dimensions and capacities

Dimensions		
Length, width	4854 mm	1904 mm
Height at kerb weight	1720 mm	
Front and rear projection		
Wheelbase	2919 mm	
Turning circle		
Track width ^{a)}	Front	Rear
	1557 – 1569 mm	1605 – 1617 mm
Capacities		
Fuel tank	70 litres. Reserve 8 litres.	
Windscreen washer fluid container with headlight washer	3.5 l / 6 l	
Tyre pressure		
Summer-grade tyres:		
The correct tyre pressure can be seen on the sticker on the inside of the tank flap.		
Winter tyres:		
The pressure of these tyres is the same as the summer tyre pressure plus 0.2 bar.		

^{a)} This data will change depending on the type of wheel rim.



CAUTION

- Special care should be taken when parking in areas with high kerbs or fixed barriers. Objects protruding from the ground may damage the bumper or other parts of the vehicle during manoeuvres.
- Special attention is required when driving through entrances, over ramps, kerbs or other objects. The vehicle underbody, bumpers, mudguards and running gear, and the engine and exhaust system could be damaged as you drive over these objects. ■

Index

- A**
- Abroad
 - Extended stay abroad with your vehicle .. 255
 - Sale of vehicle 255
 - ABS
 - See "Braking assist systems" 189
 - Accessories 257
 - Acoustic warnings
 - Headlights 97
 - Adaptive headlights
 - Dynamic 99
 - AdBlue
 - Control lamp 271
 - Information 272
 - Minimum quantity for a refill 272
 - Refilling 273
 - Specifications 274
 - Tank filling capacity 272
 - Warning lamp 271
 - Additional equipment 258
 - Additional heater
 - See "Auxiliary heater" 163
 - Adjusting passenger exterior mirror 112
 - Adjustment
 - Correct sitting position 12
 - Electric front seat 115
 - Head restraints 123
 - Mechanical front seat 114
 - Rear seats 116
 - Seat with position memory 118
 - Steering wheel 169
 - Adjustments
 - Folding the backrest of the front passenger seat 121
 - Headlight range 101
 - Aerial 255
 - Aerial built into the window 255
 - AFS 99
 - Airbag system 28, 31
 - Cleaning instrument panel 253
 - Curtain airbags 37
 - Deactivating the front passenger airbag .. 35
 - Deactivating using the key switch 35
 - Description 31
 - Differences between front passenger airbag systems 34
 - Faults 259
 - Front airbags 33
 - Function 31
 - Knee airbag 38
 - Locking the vehicle after airbag deployment 75
 - Repairs 259
 - Side airbags 36
 - Use of child seats 35
 - Vehicle care 253
 - Warning lamp 30
 - Air conditioning
 - see "Climate control" 155
 - Air recirculation mode 161
 - Air vents 161
 - Alarm system 78
 - Alcantara 251
 - All-wheel drive
 - Snow chains 301
 - Winter tyres 300
 - Alternator 289
 - Ambient lighting 102
 - Anodized surfaces 247
 - Anti-lock brake system (ABS) 189
 - Anti-theft locking bolts 305
 - Anti-theft wheel locking bolts 307
 - Anti-tow system 79
 - Anti-trap function
 - Electric windows 91
 - Panorama sliding sunroof 94
 - Sunshade 94
 - Antifreeze 285
 - Antitheft alarm 78
 - Trailer 236
 - Antitheft alarm system
 - Anti-tow system 79
 - False alarms 80
 - Interior monitoring 79
 - Antitheft bolts 321
 - Armrests 125
 - Ashtray 150

- ASR
 - See "Braking assist systems" 191
 - See "Braking assist" 190
 - Turning on and off 191
 - Assistance systems 212
 - Cruise control 212
 - Electronic differential lock system (EDS) 190
 - Assisted braking systems 189
 - Assist systems
 - Anti-lock brake system (ABS) 189
 - Auto Hold 194
 - Braking assist 190
 - Electronic stability programme ESC (ESP) 189
 - Lane Assist 215
 - Lane Assist system 215
 - Optical parking system 200
 - Park assist 199
 - Park Assist 202
 - Park Assist system 202
 - Parking sensor system 199
 - Rear Assist 207
 - Rear assist system 207
 - Sign Assist 218
 - Start-Stop 196
 - Start assist 194
 - Traction control system ASR (TCS) 191
 - Traction control when accelerating ASR (TCS) 190
 - Tyre monitoring indicator 223
 - Auto Hold 194
 - Automatic belt retainer 26
 - Automatic car wash 243
 - Switching Auto Hold off 195
 - Switching the start assist off 195
 - Automatic consumer disconnection 291
 - Automatic dipped beam control 99
 - Automatic gearbox 174
 - Changing gear 178
 - Driving 180
 - DSG automatic gearbox 180
 - Ignition key lock 172
 - Kickdown system 180
 - Launch-Control programme 180
 - Malfunction 181
 - Manually unlocking the gear selection lever 319
 - Please also see "Changing gears" 174
 - See "Automatic gearbox" 174
 - Towing 341
 - AUX-IN connection 141
 - Auxiliary heater 163, 269
 - Automatic off 265
 - Operating instructions 166
 - Programming 165
 - Remote control 164
 - Remote control range 165
 - Remote control: Replacing the battery 164
 - Switching off 163
 - Switching on 163
 - Things to note 163, 166
 - Auxiliary heater remote control
 - Replacing the battery 164
 - Axle loads 15
- ## B
- BAS
 - See "Braking assist systems" 190
 - Battery
 - Discharge 166
 - Discharging 313
 - See Vehicle battery 288
 - Battery acid 290
 - Before starting out 7
 - Belt height adjustment 26
 - Belt tension device 26
 - Disposal 27
 - Service and disposal 27
 - Belt tension limiter 26
 - Bicycle carrier
 - Installing a bicycle carrier 235
 - Maximum load 235
 - Biodiesel 270
 - Bonnet
 - Closing 278
 - Opening 278
 - Bottle capacity
 - Windscreen washer water bottle 109
 - Bottle holders 148
 - Brake 183
 - Brake servo 187
 - Electronic parking brake 185
 - Emergency braking function 186
 - Parking brake 185
 - Brake fluid 191
 - Specification 192

- Brakes
 - Assisted braking systems 189
 - Brake fluid 191
 - Brake fluid level 192
 - Brake pads 187
 - Changing the brake fluid 192
 - Control lamp 184
 - Emergency brake indicator in case of sudden braking 313
 - Running-in brake pads 187
 - Warning lamp 184
- Brake servo 187, 189
- Brake system
 - Malfunction 187
- Brake systems 189
- Braking assist 190
 - Braking assist system (BAS) 190
- Braking assist system (BAS) 190
- Breakdown
 - Securing the vehicle 312
- Bulb fault
 - See changing bulbs 326
- C**
- Card compartments 144
- Care
 - See "Care of your vehicle" 242
 - Vehicle interior 249
- Care of your vehicle
 - Exterior 242
- Caring for paintwork 247
- Carrier system 138
- Catalytic converter 229
 - Malfunction 229
 - Warning lamp 228
- CD changer 141, 148
- Central locking 74, 77
 - Antitheft alarm 78
 - Locking/unlocking the vehicle 76
- Central locking system
 - After airbag deployment 75
 - Description 75
 - Opening doors individually 75
- Centre armrest 125
- Changing
 - Windscreen wiper blades 246
- Changing a wheel 305
 - Changing a wheel 311
 - Preparations 306
 - Raising the vehicle 309
 - Wheel bolts 307
- Changing bulbs 326
 - Bodywork 333
 - Checklist 327
 - Front bumper 331
 - Halogen headlights 328
 - Indicator 326
 - Initial operations 327
 - Number plate light 335
 - Sea changing bulbs 326
 - Tailgate 332
 - Tail lights 332, 333
 - Xenon headlights 330
- Changing gear 174
 - Automatic gearbox 178
 - Engaging gears (manual gearbox) 177
 - Manual gearbox 177
 - Manually unlocking the gear selection lever 319
 - Selecting gears (automatic gearbox) 178
 - Warning and control lamps 175
- Changing gears
 - Gear recommendation 182
 - Tiptronic 180
- Changing the battery
 - of the vehicle key 73
- Changing the wheel
 - After changing the wheel 311
- Checking
 - Tyre pressures 298
- Checking the oil level 281
- Check list 7
- Checklist
 - Before working in the engine compartment 277
 - Changing bulbs 327
 - In case of an emergency 312
- Check list
 - Preparations for changing a wheel 306
 - Raising the vehicle with the jack 310
- Checklist
 - Refilling precautions 267
 - Seat belts 21
 - Transporting children in the vehicle 40
- Check list
 - Upholstery 250

- Child safety 39
- Child safety seat
 - Securing with seat belt 44
- Child seat 39
 - Integrated child seat 45
 - ISOFIX child seat on rear seats 43
 - Mounting child seats 41
 - Mounting systems 42
 - On rear seats 43
 - On the front passenger seat 42
 - Regulations 40
 - Securing using a Top Tether retaining strap 45
 - Securing using ISOFIX 44
 - Securing using LATCH 44
 - Transporting children in the vehicle 40
 - Weight categories 41
- Child seats
 - Disabling the front passenger airbag 35
- Cigarette lighter 150, 151
- Cleaning
 - Alcantara 251
 - Engine compartment 249
 - instrument panel 253
 - Seat belts 253
 - See "Care of your vehicle" 242
 - wheels 248
 - Windscreen wiper blades 246
- Cleaning chrome parts 247
- Cleaning the vehicle
 - Folding exterior mirrors 113
- Climate control 155
 - Air recirculation mode 161
 - Air vents 161
- Climatic 157
 - Climatronic 157
 - Controls 157
 - Faults 160
 - Indirect ventilation 161
 - Things to note 160
 - User instructions 159
- Climatic
 - see "Climate control" 155
- Climatronic
 - see "Climate control" 155
- Closing
 - Doors 80
 - Electric sliding door 82
 - Electric windows 89
 - Panorama sliding sunroof 92
 - See "Locking" 76
 - Sliding doors 81
 - Sunshade 93
 - Tailgate 86
- Coat hooks 147
- Cockpit 53
- Code number 321
- Collection of end-of-life vehicles 256
- Combined weight rating 240
- Coming Home 101
- Compartment
 - Glove compartment 144
- Compartments
 - Card compartments 144
 - Centre console 143
 - Drawers 146
 - Folding table 146
- Front central armrest 143
- Instrument panel 142
- Other storage compartments 147
- Portable waste bin 147
- Rear floor area 145
- Spectacle case 142
- Compass 60
- Components 258
- Connectors
 - Faults 154
- Consumer disconnection 291
- Consumption
 - How it is determined 270
 - Information 270
- Control lamp
 - AdBlue 271
 - Brake pad wear indication 184
 - Brake system 184
 - Changing gear 175
 - Coolant 284
 - Cruise control 212
 - Engine oil sensor 279
 - ESP 184
 - Filling the tank 265
 - Fuel level 265
 - Lane assist system 216
 - Pressing the brake 184
 - Steering column lock 167
 - Tyre monitoring indicator 222
 - Tyre monitoring systems 222
 - Windscreen wiper fluid level 105
- Controlling function
 - Electric exterior mirrors 113

- Control of function
 - Rain sensor 108
 - Control units 260
 - Reprogramming 261
 - Convenience closing
 - Electric windows 90
 - Panorama sliding sunroof 94
 - Convenience functions
 - Reprogramming 261
 - Convenience opening
 - Electric windows 90
 - Panorama sliding sunroof 94
 - Convenient entry function for the third row of seats 120
 - Coolant
 - Control lamp 284
 - See engine coolant 283
 - Temperature gauge 284
 - Warning lamp 284
 - Counter steering assistance system 168
 - Crossing a river
 - Salt water 9
 - Cruise control 212
 - Control lamp 212
 - Operations 213
 - Warning lamp 212
 - Cruise control system 212
 - Cup holder 149
 - Cup holders 148, 150
 - Curb weight 15
 - Curtain airbags
 - See "Airbag system" 37
- D**
- Damaged tyres 299
 - Dangers of not using the seat belt 20
 - Dash panel 53
 - Airbag system 31
 - Data link connector (DLC) 261
 - Data plate 345
 - Model identification 345
 - Technical specifications 345
 - Vehicle chassis number 345
 - Data registry 260
 - Data storage during the journey 260
 - Data stored by the control units 260
 - Daytime driving light 98
 - De-icing the door lock cylinder 248
 - De-icing the locks 248
 - Details
 - Driving with a trailer 237
 - Diagnostics connection 261
 - Diesel 269
 - Auxiliary heater 269
 - Biodiesel 270
 - Filling the tank 266
 - Filter pre-heater 269
 - Fuel gauge 265
 - Winter-grade diesel 269
 - Diesel particle filter
 - Malfunction 229
 - Diesel particulate filter 229
 - Recommended gear 182
 - Things to note 270
 - Warning lamp 228
 - Differential lock
 - See "Braking assist systems" 190
 - Digital clock 57
 - Dipped beam headlight 97
 - Dipstick 281
 - Display 57, 58
 - Disposal
 - Airbag system 256
 - Belt tension device 27
 - End-of-life vehicle 256
 - Door release lever 53
 - Doors 80
 - Child safety lock 83
 - Emergency locking and unlocking 315
 - Warning indicator 80
 - Drawbar load 231
 - Loading the trailer 236
 - Drawers 146
 - Driving
 - Automatic gearbox 180
 - Check list 8
 - Cross country 7
 - Data storage 260
 - Driving abroad 8
 - Driving through water 9
 - Ecological 225
 - Economic 225
 - Fuel gauge 265
 - Fuel level to low 266

- Parking downhill 186
 - Parking uphill 186
 - Tips 7
 - Towing 343
 - Trailer 237
 - Undercarriage guard 7
 - Driving abroad
 - Check list 8
 - Headlights 100
 - Driving advice
 - For a loaded vehicle 13
 - Driving in winter
 - Fuel consumption 227
 - Snow chains 301
 - Tread depth 299
 - Tyre pressures 297
 - Windscreen washer bottle 245
 - Winter tyres 300
 - Driving through water 9
 - Driving with a trailer 233
 - Extinguisher 234
 - Technical requirements 233
 - DSG 180
 - DSG automatic gearbox
 - See "Automatic gearbox" 180
 - DSG Automatic gearbox
 - Malfunction 181
 - Dust filter 160
 - Dynamic headlight range control 101
 - Dynamic headlight range control 101
- E**
- Ecological driving 225
 - Economic driving 225
 - EDS
 - See "Braking assist systems" 190
 - Electrical components 152, 313
 - Electrical consumers 153, 166
 - Electrical sockets 151
 - Electric child safety lock 83
 - Electric devices 236
 - Electric sliding doors
 - Opening and closing 82
 - Rollback anti-trap function 82
 - Electric sockets
 - Trailer 236
 - Electric windows 89
 - Anti-trap function 91
 - Automatic one-touch operation 90
 - Closing 89
 - Convenience closing 90
 - Convenience opening 90
 - Fault 90
 - One-touch opening/closing 90
 - Opening 89
 - Electronic differential lock system (EDS) 190
 - Electronic immobiliser 174
 - Electronic parking brake 185
 - Electronic stability programme ESC (ESP) ... 189
- Emergencies**
- Fire extinguishers 314
 - First aid kit 314
 - Hazard warning triangle 314
 - Emergency brake indicator 313
 - Emergency braking function 186
 - Emergency locking and unlocking 314
 - Driver's door 315
 - Manually unlocking the gear selection lever 319
 - Panoramic sliding roof 318
 - Passenger side door 316
 - Sliding doors 316
 - Tailgate 317
 - Engine
 - Noises 173
 - Running-in 225
 - Engine and ignition 170, 173
 - 12 Volt sockets 152
 - Ignition lock 171
 - Immobiliser 174
 - Pre-heating 172
 - Starting the engine 172
 - Unauthorised vehicle key 171
 - Engine compartment 275
 - Engine coolant 283
 - Engine oil 279
 - Preparation 277
 - Vehicle battery 288
 - Water box 249
 - Engine coolant 283
 - Checking the level 286
 - Filler 286

- G 12 plus-plus 285
- Refilling 286
- Specifications 285
- Engine fault 228
- Engine management 228
 - Warning lamp 228
- Engine oil 279
 - changing 282
 - Checking the oil level 281
 - Consumption 282
 - Dipstick 281
 - Filler opening 281
 - Indicator 279
 - Specifications 280
 - Topping up 281
- ESC
 - See "Braking assist systems" 189
- ESP
 - see ESC 189
- Event Data Recorder 261
- Exhaust gas purification system 228
 - Warning lamp 228
- Exterior aerial 260
- Exterior mirrors 112
 - Automatically folding exterior mirrors 112
 - Controlling function 113
 - Synchronised mirror adjustment 112
 - Vehicle care 245
- Extinguisher
 - Driving with a trailer 234
- F**
- Fastening rings 133
- Fault
 - Electric windows 90
 - Park assist system 203
 - Parking sensor system 199
 - Rear assist 209
- Fault memory
 - Connector 261
- Faults
 - Climate control 160
 - Panorama sliding sunroof 92
- Filling capacity
 - AdBlue tank 272
- Filling the tank 264
 - Control lamp 265
 - Diesel 266
 - Fuel 266
 - Fuel gauge 265
 - Petrol 266
 - Refilling precautions 267
- Filter pre-heater 269
- Fire extinguisher 314
- Fire extinguishers 314
- First-aid kit
 - Storage 314
- First aid kit 314
- Fitting
 - Tow hitch 239
- Floor mats 176
- Fluids 258
- Fog light 98
- Folding down rear seats
 - Load space 127
- Folding in exterior mirrors 112
- Folding table 146
- Folding the backrest of the front passenger seat 121
- Four-wheel-drive
 - Towing 341
- Front airbags
 - See "Airbag system" 33
- Front passenger airbag
 - Deactivating using the key switch 35
 - See "Airbag system" 31
- Fuel 267
 - Depending on the engine 268
 - Diesel 269
 - Filling the tank 266
 - Information on consumption 270
 - Petrol 268
 - Type of fuel 268
- Fuel consumption
 - Economic driving 225
 - Why does fuel consumption increase? ... 229
- Fuel gauge 265
 - Control lamp 265
- Fuel tank flap
 - Closure 266
 - Opening 266
- Function control
 - Tow hitch 236

- Fuses 322
 - Fuse box 323
 - Identification using colours 323
 - Identifying blown fuses 324
 - Preparation before replacing 324
 - Replacement 324

- G**
- G 12 plus 285
- G 12 plus-plus 285
- General overview of the engine compartment 348
- Glove compartment 144
- Glove compartment lighting 102

- H**
- Handbrake
 - See "Parking brake" 185
- Hazard warning lights 312
- Hazard warning triangle 314
- Headlamp range adjustment 53
- Headlight adjustment 99
- Headlight range control 101
- Headlights
 - Adaptive headlights 99
 - Dipped beam headlights 97
 - Driving abroad 100
 - Headlight control 97
 - Headlight washers 107
 - Side light 97
 - Turning lights 99
- Head restraint 124
- Head restraints 123
- Heated rear window 158
- Heated seats 117
- High pressure cleaning equipment 244
- Hitch ball
 - Electric release 234
- Horn 53

- I**
- Ignition
 - See "Engine and ignition" 170
- Ignition lock 171
 - Key removal lock 172
 - Unauthorised vehicle key 171
- Immobiliser 174
 - Operating fault 170
- In case of a breakdown
 - Securing the vehicle 312
- In case of an emergency
 - Checklist 312
 - Hazard warning lights 312
 - In case of a breakdown 312
 - Protecting yourself and securing the vehicle 312
- In case of emergency 312
- Indication on display
 - Sign Assist 219
- Indicator
 - Changing bulbs 326
 - Checking the engine oil level 279
- Engine oil pressure 279
- Vehicle key 73
- Information on consumption 270
- Initial operations
 - Changing bulbs 327
- Instrument panel 57, 63
 - Airbag system 253
 - Display 57, 58, 63
- Instruments 57
- Lamps 54
- Menus 65
- Service interval display 61
- Integrated child seat 45
 - Seat belt routing 48
 - Setting up 47
- Integrated seat belt
 - Removing 49
- Interior monitoring 79
- ISOFIX 44

- J**
- Jack 305
 - Raising the vehicle 309

- K**
- Keys 71
 - Assigning a key 71
 - Changing the battery (vehicle key) 73
 - Indicator 73
 - Remote control 71

Spare key	71
Vehicle key	71
Key switch	
Deactivating the front passenger airbag ..	35
Kickdown system	180
Knee airbag	
See "Airbag system"	38
L	
Labels	255
Lamps	
Audible warnings	54
Control lamps	54
Warning lamps	54
Lane Assist	215
Lane assist system	216
Control lamp	216
Malfunction	215
Operation mode	216
When is it necessary to disconnect it? ..	217
Lane Assist system	215
LATCH	44
Launch-Control programme	180
Leaving Home	101
Lifting platform	262
Lights	95
Acoustic warnings	97
AUTO	99
Coming home	101
Daytime driving light	98
Fog light	98

Functions	98
Headlight range control	101
Instrument lighting	101
Interior lights	102
Leaving home	101
Main beam lever	96
Parking light	98
Reading lights	102
Remote control	164
Switch lighting	101
Turn signal lever	96
Warning lamps	95
Load	
Driving with the tailgate open	14
Transporting a load	14
Loading	125
Fastening rings	133
General advice	13
Loading luggage compartment	125
Net partition	132
Rails and attachment system	134
Roof carrier system	140
Trailer	236
Loading the vehicle	13
Locking	
From the inside	77
Tailgate	86
The tailgate	76
The vehicle from the outside	76
Locking button	178

Luggage compartment	
Extension	127
Folding down rear seats to create load space	127
Luggage compartment lighting	102
Net	138
Net partition	132
Rails and attachment system	134
Luggage compartment baggage net	138

M

Main beam headlight	97
Main beam lever	96
Main panel	
Turn signal and main beam lever	96
Maintenance and cleaning	242
Malfunction	
Automatic gearbox	181
Catalytic converter	229
Diesel particle filter	229
DSG automatic gearbox	181
DSG Automatic gearbox	181
Lane assist system	215
Manual gearbox	174
Please also see "Changing gears"	174
MEDIA-IN connection	141
Menus	
Structure	63
Mirrors	
Adjusting passenger mirror	112
Convenience function	112
Exterior mirrors	112

- Folding exterior mirrors 113
 - Rear vision mirror 111
 - Synchronised mirror adjustment 112
 - Mobile telephone
 - Using without an exterior aerial 261
 - Mobile tow hitch
 - Installing a bicycle carrier 235
 - Model identification 345
 - Modifications 255, 258
 - Modifications to the vehicle 257
 - Labels 255
 - Plates 255
- N**
- Net
 - Luggage compartment 138
 - Net partition 132
 - New engine 225
 - New tyres 296
 - New tyres and wheels
 - About your tyres and wheels 294
 - Noise
 - Auxiliary heater 166
 - Engine 269
 - Parking brake 186
 - Tyres 301
 - Noises
 - Assisted braking systems 191
 - Engine 173
 - Notes for the user 255
 - Number of seats 10
- O**
- Octane rating 268
 - Odometer 57
 - Oil
 - See engine oil 279
 - Older tyres 295
 - On-board tools
 - Components 321
 - Location 320
 - Onboard diagnostic system (ODB) 261
 - Opening
 - Doors 80
 - Electric sliding door 82
 - Electric windows 89
 - From the inside 77
 - Panorama sliding sunroof 92
 - See "Unlocking" 76
 - Sliding doors 81
 - Sunshade 93
 - Tailgate 85
 - Opening doors individually 75
 - Operating fault
 - Immobiliser 170
 - Operating faults
 - Radio reception 256
 - Optical parking system 200
 - Outside temperature 59
 - Overview
 - Dash panel 53
- P**
- Panorama sliding sunroof 92
 - Anti-trap function 94
 - Closing 92
 - Convenience closing 94
 - Convenience opening 94
 - Fault 92
 - Opening 92
 - Sunshade 93
 - Panoramic sliding roof
 - Emergency locking 318
 - Park assist 199
 - Park Assist 202
 - Brake operation 205
 - Park assist system
 - Automatic stoppage 205
 - Fault 203
 - Leaving the parking space 205
 - Parking 204
 - Preparing to park 203
 - Stopping 204
 - Switching on or off (leaving the parking space) 205
 - Switching on or off (parking) 204
 - Park Assist system 202
 - Parking 183, 186
 - Parking aid system
 - Use of high pressure cleaning equipment 244
 - Parking brake 185
 - Automatic release 186
 - Connection 185
 - Emergency braking function 186

- Release 185
 - See "Parking brake" 185
 - Parking distance warning system
 - Use of high pressure cleaning equipment 244
 - Parking indicator 199
 - Parking light 98
 - Parking sensor system 198, 199
 - Fault 199
 - Optical parking system 200
 - With towing bracket 199
 - Particulate filter 229
 - Pedals 12, 176
 - Petrol
 - Additives 268
 - Filling the tank 266
 - Fuel 268
 - Fuel gauge 265
 - Types 268
 - Plates 255
 - Polishing 247
 - Pollen filter 160
 - Pollution filter 160
 - Portable waste bin 147
 - Pre-heating 172
 - Preparation
 - Checking the engine coolant level 286
 - Vehicle battery 290
 - Work in the engine compartment 277
 - Preparations
 - Changing a wheel 306
 - Checking the engine oil level 281
 - Topping up the engine oil level 281
 - Preparing for the journey 7
 - Principles of physics regarding a frontal collision 19
 - Protection of vehicle undercarriage 248
 - Pushing 170
- R**
- Radio reception
 - Aerial 255
 - Operating faults 256
 - Rails and attachment element system
 - Baggage net 135
 - Rails and attachment system 134
 - Rain sensor 108
 - Control of function 108
 - Raising the vehicle
 - Check list 310
 - Jack 309
 - Raising vehicle
 - Lifting platform 262
 - With a lifting platform 262
 - Reading the
 - Fault memory 261
 - Rear assist
 - Fault 209
 - Mode 1 209
 - Mode 2 210
 - Screen 208
 - Things to note 209
 - User instructions 208
 - Rear Assist 207
 - Rear assist systems 207
 - Rear seats 127
 - Rear shelf 130
 - Rear vision mirror 110, 111
 - Rear vision mirrors 111
 - Recommended gear 182
 - Recycling 256
 - Refilling precautions 267
 - Reflective vest 314
 - Reflective vests 314
 - Refuelling
 - Mistakes 265
 - Remote control
 - Auxiliary heater 164
 - See "Keys" 71
 - Removing ice 245
 - Removing snow 245
 - Removing wax deposits 245
 - Repairs 257, 258
 - Airbag system 259
 - Labels 255
 - Lifting platform 262
 - Plates 255
 - Replacement of parts 257
 - Reprogramming control units 261
 - Retaining hooks 137
 - Retro-fitting
 - Two-way radios 260
 - Vehicle telephone 260
 - Rev counter 57
 - Reversing camera 207

- Rocker switches
 - Tiptronic 180
 - Rollback anti-trap function
 - Electric sliding doors 82
 - Roof carrier system 138
 - Rubber seals 248
 - Run-flat tyres
 - Codes 302
 - Running-in
 - Brake pads 187
 - First trips 225
 - Running-in brake pads
 - Please also see "Brakes" 187
 - Running in
 - Engine 225
 - Tyres 296
 - Wheels and tyres 296
- S**
- SAFE 77, 174
 - Safe driving 7
 - Check list 7
 - Safety equipment 31
 - Sale of vehicle
 - In other countries / continents 255
 - Salt water 9
 - Scrapping 256
 - Seat adjustment
 - Front seats 114
 - Seat belt position 24
 - Seat belt protection 21
 - Seat belts 16, 21
 - Automatic belt retainer 26
 - Belt height adjustments 26
 - Belt tension device 26
 - Belt tension limiter 26
 - Checklist 21
 - Fastening 22
 - Seat belt position 24
 - Seat belt status display 17
 - Twisted belt 22
 - Unfastened 20
 - Unfastening 22
 - Use 21
 - Warning lamp 17
 - With two buckles 23
 - Seat belt warning lamp 17
 - Seat belt with two buckles
 - Fastening 23
 - Twisting 23
 - Unfastening 23
 - Seat functions 117
 - Convenient entry function for the third row of seats 120
 - Folding the backrest of the front passenger seat 121
 - Seat heating 117
 - SEAT information system 62
 - Seats 10
 - Adjusting the head restraints 123
 - Adjusting the steering wheel position ... 169
 - Convenient entry function for the third row of seats 120
 - Correct position 12
 - Electric front seat 115
 - Fitting the head restraints 124
 - Folding the backrest of the front passenger seat 121
 - Heated seats 117
 - Mechanical front seat 114
 - Number of seats 10
 - Rear seats 116
 - Removing the head restraints 124
 - Seat with position memory 118
 - Seat with position memory 118
 - Selective Catalytic Reduction 271
 - Selector lever locking 178
 - Service interval display 61
 - Service notification: read 61
 - Side airbags
 - See "Airbag system" 36
 - Side light 97
 - Sign Assist 218, 219
 - Connection 220
 - Disconnection 220
 - Indication on display 219
 - Operation mode 219
 - Trailer 220
 - Sitting position
 - Incorrect position 11
 - Sliding door
 - Manually opening and closing 81
 - Sliding doors 81
 - Child safety lock 83
 - Opening and closing electrically 82
 - Snow chains 301, 347
 - All-wheel drive 301

- Sockets
 - 12 Volts 153
 - Faults 154
- Spanner symbol 61
- Spare fuel canister 264
- Spare parts 257
- Special features
 - Automatic car wash 243
 - Folding exterior mirrors 113
 - High pressure cleaning equipment 244
 - Parking 183, 187, 363
 - Pushing 170
 - Radio reception 255
 - Removing the vehicle key 172
 - Washing the vehicle 243
 - Windscreen wipers 106
- Special notes
 - High-pressure cleaning system 235
 - Long parking times 74
 - Towing 340, 341
 - Tow starting 341
- Specifications
 - Combined weight 240
 - Drawbar load 231
 - Trailer weight 240
- Specific notes
 - Electric sliding doors 82
- Spectacle case 142
- Speed rating 303
- Stabilising the vehicle and trailer combination 238
- Start-Stop function
 - Driving with a trailer 231
- Start-Stop Function 196
- Start assist
 - See "Start assist systems" 194
- Starting assistance 337
 - Description 338
 - Jump leads 338
 - Positive pole on the starting assistance points 338
- Starting using an external battery
 - See Starting assistance 337
- Steering
 - Control lamp 167
 - Counter steering assistance system 168
 - Electromechanical 168
 - Power steering 168
 - Steering column lock 168
 - Tendency to pull to one side 299
 - Warning lamp 167
- Steering wheel
 - Adjustment 169
 - Rocker switches (Tiptronic) 180
- Storage compartments 141
 - Glove compartment lighting 102
- Sudden braking 313
- Sun blind 103
- Sun blinds
 - Rear side windows 103
- Sunshade
 - Anti-trap function 94
 - Closing 93
 - Opening 93
- Sun visor 103
- Symbols
 - See "Lamps" 54
- System
 - Automatic dipped beam control 99
- Systems
 - ABS 189
 - Adaptive headlights 99
 - Anti-lock brake system (ABS) 189
 - ASR 190
 - Auto Hold 194
 - BAS 190
 - Braking assist 190
 - Braking assist system (BAS) 190
 - Cruise control 212
 - EDS 190
 - Electronic differential lock system (EDS) 190
 - Electronic stability programme ESC (ESP) 189
 - ESC (ESP) 189
 - Lane Assist 215
 - Lane Assist system 215
 - Launch-Control Programme 181
 - Optical parking system 200
 - Park assist 199
 - Park Assist 202
 - Park Assist system 202
 - Parking sensor system 199
 - Rear Assist 207
 - Rear assist system 207
 - Sign Assist 218
 - Start-Stop 196
 - Start assist 194
 - TCS 191
 - Traction control system 191

- Traction control when accelerating ASR (TCS) 190
 - Tyre monitoring indicator 223
 - Tyre monitoring systems 221
- T**
- Tailgate 84
 - Closing 86
 - Driving with the tailgate open 14
 - Electronic locking 87
 - Electronic opening 87
 - Emergency locking and unlocking 317
 - Opening 85
 - See "Tailgate" 84
 - Unlocking 85
 - Warning indicator 85
 - TCS
 - see ASR 191
 - Technical data
 - Axle loads 15
 - Bottle capacity 109
 - Curb weight 15
 - Engine oil specifications 280
 - Roof load 140
 - Total weight 15
 - Tyre pressures 297
 - Weights 15
 - Technical details
 - Type of fuel 268
 - Technical modifications 258
 - Labels 255
 - Lifting platform 262
 - Plates 255
 - Technical specifications 345
 - Temperature display
 - Outside temperature 59
 - Temperature gauge
 - Coolant 284
 - The tailgate
 - Locking 76
 - See "The tailgate" 76
 - Unlocking 76
 - Things to note
 - Auxiliary heater 163, 166
 - Diesel particulate filter 270
 - Electric sliding doors 82
 - Fumes 166
 - Increase in exhaust fumes 269
 - Parking sensor system 199
 - Rear assist 209
 - Switching Auto Hold off 195
 - Water underneath the vehicle 160
 - Tightening torque
 - Wheel bolts 307
 - Tightening torque of wheel bolts 347
 - TIN 302
 - Tips for driving
 - Before starting out 7
 - Tiptronic 180
 - Tools 320
 - Total weight 15
 - Tow hitch
 - Function control 236
 - Installing a bicycle carrier 235
 - Towing 340
 - Automatic gearbox 341
 - Driving advice 343
 - Four-wheel-drive 341
 - Front tow ring 342
 - Rear tow ring 342
 - Special notes 341
 - Tow bar 341
 - Towing prohibited 341
 - Towing rope 341
 - With a tow hitch 341
 - Towing a trailer 347
 - Towing bracket
 - Optical parking system 201
 - Parking sensor system 199
 - Tow starting 341
 - Traction 303
 - Traction control system ASR (TCS) 191
 - Traction control when accelerating ASR (TCS) 190
 - Trailer
 - Adjusting the headlights 237
 - Antitheft alarm 236
 - Connection 235
 - Drawbar load 231
 - Driving with a trailer 233, 237
 - Electrically releasing the hitch ball 234
 - Electric socket 236
 - Fitting a trailer tow hitch 239
 - Function control 236
 - Hitch ball 234

- Hitching 235
- Loading 236
- Rear LED lights 233, 236
- Rear lights 233, 236
- Stabilising the vehicle and trailer combination 238
- Trailer cable 233, 235
- Trailer weight 240
- Wing mirrors 233
- Trailer cable 233, 235
- Trailer hitch ball
 - See "Trailer" 233
- Trailer tow hitch
 - Electric release 234
- Trailer weight
 - Permitted maximum 240
- Trailer weights 347
- Transport
 - Folding the backrest of the front passenger seat 121
- Transporting
 - Transporting a load 14
- Transporting a load 14
- Transporting children in the vehicle 40
 - Checklist 40
- Transporting objects
 - Baggage net 138
 - Driving advice 15
 - Driving with a trailer 233, 237
 - Driving with the tailgate open 14
 - Loading the trailer 236
 - Net partition 132
 - Rails and attachment system 134
 - Retaining hooks 137
 - Roof carrier system 138, 140
 - Trailer weight 240
 - Tread depth 299
 - Treadwear 303
 - Trip recorder 57
 - Turning lights
 - See "Static turning lights" 99
 - Static 99
 - Turning off the lights 97
 - Turning on the headlights 97
 - Turn signal convenience function 96
 - Turn signal lever 96
 - Two-way radios 260
 - Type of fuel 268
 - Tyre control systems
 - Tyre pressures 298
 - Tyre load rating 303
 - Tyre monitoring indicator 223
 - Tyre monitoring systems
 - Control lamp 222
 - Tyre monitoring indicator 223
 - Tyre pressures 297, 347
 - Tyres with directional tread pattern 303

U

 - Undercarriage guard 7
 - Unlocking
 - From the inside 77
 - The tailgate 76
 - The vehicle from the outside 76
 - Upholstery 249
 - Check list 250
 - Cleaning and care of real leather upholstery 252
 - Cleaning textile covers 251
 - Cleaning upholstery 251
 - Imitation leather 253
 - Treating your upholstery 250

V

 - Valve caps 298
 - Vehicle
 - Collection 256
 - Parking downhill 186
 - Parking uphill 186
 - Recycling 256
 - Securing in case of a breakdown 312
 - Vehicle battery 288
 - Acid 290
 - Checking the electrolyte level 290
 - Discharging 172
 - Disconnect 62
 - Explanation of symbols 288
 - Location 288
 - Positive pole on the starting assistance points 338
 - Preparation 290
 - Starting assistance 338
 - Warning lamp 289
 - Vehicle care
 - Aerial built into the window 255
 - Airbag modules (instrument panel) 253

- Alcantara 251
 - Anodized surfaces 247
 - Automatic car wash 243
 - Changing windscreen wiper blades 246
 - Chrome parts 247
 - Cleaning compartments 253
 - Cleaning seat belts 253
 - Cleaning wheels 248
 - Cleaning windscreen wiper blades 246
 - De-icing the door lock cylinder 248
 - Engine compartment 249
 - Exterior mirrors 245
 - High pressure cleaning equipment 244
 - Imitation leather 253
 - Instrument panel 253
 - Plastic parts 253
 - Protection of vehicle undercarriage 248
 - Real leather 252
 - Rubber seals 248
 - Service position 107
 - Special features 243, 244
 - Textile covers 251
 - Treating your upholstery 250
 - Upholstery 251
 - Vehicle paintwork 247
 - Washing by hand 243
 - Washing the vehicle 243
 - Windows 245
 - Wooden trim 253
 - Vehicle chassis number 345
 - Vehicle code 345
 - Vehicle data label 345
 - Vehicle key
 - Synchronising 74
 - Vehicle key set
 - See "Keys" 71
 - Vehicle specifications 345
 - Vehicle telephone 260
 - Vehicle's battery
 - Automatic consumer disconnection 291
 - Charging 291
 - Connecting 291
 - Disconnecting 291
 - Replacing 291
 - Running flat 292
 - Vibrations
 - Steering 299
- ## W
- Warning indicator
 - Doors 80
 - Tailgate 85
 - Warning lamp
 - AdBlue 271
 - Airbag system 30
 - Alternator 289
 - Brake system 184
 - Catalytic converter 228
 - Changing gear 175
 - Coolant 284
 - Cruise control 212
 - Diesel particulate filter 228
 - Engine management 228
 - Exhaust gas purification system 228
 - Pressing the brake 184
 - Seat belts 17
 - Vehicle battery 289
 - Warning lamps
 - Lights 95
 - Warning triangle 314
 - Washing
 - by hand 243
 - Washing the vehicle 243
 - Sensors 198, 203
 - Special features 243
 - with high pressure cleaning equipment .. 244
 - Water box 249
 - Wear indicators 299
 - Wear of tyres 299
 - Weights 15
 - Wheel bolts 305, 307, 347
 - Caps 305
 - Tightening torque 307
 - Wheel load capacity 302
 - Wheel rims 296
 - Beadlock 296
 - Bolted trims 296
 - See "Wheels and tyres" 293
 - Wheels 347
 - Wheels and tyres 293
 - Avoiding damage 294
 - Changing a wheel 305
 - Code 302
 - Damaged tyres 299
 - Errors in wheel alignment 300
 - Foreign bodies in the tyres 299

- Interchanging tyres 295
- New tyres 296
- Older tyres 295
- Replacing tyres 296
- Run-flat tyre codes 302
- Run-out 300
- Serial number 302
- Snow chains 301
- Speed rating 302, 303
- Storing tyres 295
- Technical data 302
- Tread depth 299
- Tyre code 302
- Tyre identification number (TIN) 302
- Tyre load rating 303
- Tyre pressures 297
- Tyre pressure sensor 298
- Tyres with directional tread pattern . 295, 303
- Valve caps 298
- Wear indicators 299
- Wear of tyres 299
- Wheel balance 300
- Wheel rims 296
- Winter tyres 300
- Wheel trims 304
 - Full hub caps 304
 - Wheel bolts caps 305
- Windows
 - See "Electric windows" 89
- Windscreen heating 158
- Windscreen washer 105
 - Windscreen washer water
 - Checking 109
 - Topping up 109
 - Windscreen wiper 105
 - Windscreen wiper lever 106
 - Windscreen wiper fluid
 - Control lamp 105
 - Windscreen wipers
 - Functions 107
 - Headlight washer system 107
 - Heated windscreen washer jets 107
 - Lifting the wiper blades 107
 - Rain sensor 108
 - Replacing the wiper blades 107
 - Service position 107
 - Special features 106
 - Windscreen wipers service position 107
- Wing mirrors
 - Driving with a trailer 233
- Winter
 - Additional heater 163
 - Menu configuration 68
- Winter-grade diesel 269
- Winter driving
 - Driving with a trailer 231
 - Filter pre-heater 269
 - Winter-grade diesel 269
- Winter operation
 - Headlight washers 107
 - Heated windscreen washer jets 107
 - Salt on the roads 109
- Winter tyres 300
 - All-wheel drive 300
 - Speed limit 300

Other Characters

"Safe" security system 77

SEAT S.A. is permanently concerned about continuous development of its types and models. For this reason we ask you to understand, that at any given time, changes regarding shape, equipment and technique may take place on the car delivered. For this reason no right at all may derive based on the data, drawings and descriptions in this current handbook.

All texts, illustrations and standards in this handbook are based on the status of information at the time of printing. Except for error or omission, the information included in the current handbook is valid as of the date of closing print.

Re-printing, copying or translating, whether total or partial is not allowed unless SEAT allows it in written form.

SEAT reserves all rights in accordance with the “Copyright” Act.

All rights on changes are reserved.

 This paper has been manufactured using bleached non-chlorine cellulose.

© SEAT S.A. - Reprint: 15.09.11

